



GigaVUE-FM User's Guide

GigaVUE

Product Version: 5.8.00

Document Version: 2.0

(See Change Notes for document updates.)

Copyright 2020 Gigamon Inc.. All rights reserved.

Information in this document is subject to change without notice. The software described in this document is furnished under a license agreement or nondisclosure agreement. No part of this publication may be reproduced, transcribed, translated into any language, stored in a retrieval system, or transmitted in any form or any means without the written permission of Gigamon Inc..

Trademark Attributions

Copyright © 2020 Gigamon Inc. All rights reserved. Gigamon and the Gigamon logo are trademarks of Gigamon in the United States and/or other countries. Gigamon trademarks can be found at www.gigamon.com/legal-trademarks. All other trademarks are the trademarks of their respective owners.

Gigamon Inc.
3300 Olcott Street
Santa Clara, CA 95054
408.831.4000

Change Notes

When a document is updated, the document version number on the cover page will indicate a new version and will provide a link to this Change Notes table, which will describe the updates.

Product Version	Document Version	Date Updated	Change Notes
5.8.00	1.0	12/6/2019	Original release of this document with 5.8.00 GA.
5.8.00	2.0	12/23/2019	<ul style="list-style-type: none">• Fixed formatting issues, cross-references and streamlined instructions throughout the guide.• Starting with release 5.8 the GigaVUE-FM Graphical User Interface is enhanced for visual appeal, better navigation and improved readability. In line with this enhancement, the old screenshots have been replaced with the new GUI screens throughout the guide.

Contents

- GigaVUE-FM User's Guide 1**
 - Change Notes 3
- 5.8.00 GigaVUE-FM User's Guide 9**
- GigaVUE® Fabric Management 10**
- GigaVUE-FM 11**
 - GigaVUE-FM Overview 11
 - GigaVUE-FM Features and Benefits 12
 - Supported GigaVUE G Series, TA Series, and H Series Nodes 14
 - Device Management 14
 - Configuration Management 15
 - How to enable Web Server for Node Management 16
 - Get Started with GigaVUE-FM 16
 - Log In to GigaVUE-FM 17
 - Log Out of GigaVUE-FM 17
 - GigaVUE-FM Navigation 17
 - Configure a Custom Banner 22
 - Quick Views 23
 - Return to the Dashboard 23
 - Table View Customization 23
 - Notifications Panel 24
 - How to Add the GigaVUE-FM Instance Name 26
 - How to Search in GigaVUE-FM 27
 - New GigaVUE-FM GUI in 5.8 39
 - Changes in Login Page 40
 - Changes in Landing Page 40
 - Changes in Navigation Paths 42
 - Changes in Quick Views 48
 - Changes in Icons 49
 - Dashboard 51

- Physical Dashboard 52
- Health Monitor Dashboard 80
- GigaVUE® Nodes and Clusters 86**
- GigaVUE Nodes and Clusters 86
- GigaVUE H Series and TA Series Overview 86
- About Cluster 89
- Manage GigaVUE® Nodes and Clusters 91
- Configure Physical Nodes 91
- Create and Manage Clusters 99
- Creating Clusters: A Roadmap 108
- Cluster Rules and Recommendations 109
- Cluster Safe and Limited Modes 114
- Inband Cluster Management 122
- Export Nodes and Clusters 131
- Upgrade Software on a GigaVUE Node or a Cluster from GigaVUE-FM 131
- Problems with SCP? 138
- Search for Specific Nodes Using Keywords 139
- Search for Ports on a GigaVUE Node 140
- Overview Page 142
- Workflows 143
- Chassis Table View 146
- Live Graphing 147
- Safe and Limited Modes 147
- Multi-Path Leaf and Spine 150
- Introduction to Multi-Path Leaf and Spine 150
- Configuration Overview 155
- Leaf-Spine Cluster Deployment 157
- Spine to Spine and Leaf 169
- Introduction to Spine to Spine and Leaf 170
- Configuration Overview 171
- Configuration of Spine to Spine and Leaf Architecture 173
- Limitations 174
- Leaf-Spine Cluster Deployment 174
- Work with GigaVUE HC TAP Modules 176
- Fiber TAPs 176
- Copper TAPs 177
- Best Practices When Working with GigaVUE Modules 181

- Fabric Statistics 181
 - About Fabric Statistics 181
 - Display Fabric Statistics for All Ports 182
 - Display Fabric Statistics for a Single Port 185
 - Export Fabric Statistics 186
 - Filter Fabric Statistics 186
- Topology Visualization 187
 - Overview of Topology 187
 - Enable Discovery Protocols 189
 - Table View 206
 - How to Customize Topology 207
 - Export and Import Topology 225
 - FabricVUE Topology Views 227
 - Redistribute Traffic Flows 233
- Flows 241
 - About Flows 241
 - View Flows 245
 - View the Flow Summary and Statistics 246
 - How to Change the Flow Layout 254
 - How to Update Flows 256
 - View Events 258
 - Set Notifications 258
 - Limitations of Flows 259
- Device Logs and Event Notifications 259
 - Stream Device Logs to GigaVUE-FM 259
 - View Device Logs 264
 - Device Log Host Servers 267
 - Storage Management for Device Logs 270
 - Manage Device Log Output 272
 - Device Event Notifications 273
- Traffic Filtering 276**
 - Ports and GigaStreams 276
 - About Ports 277
 - Managing Ports 288
 - Port Discovery 310
 - Ingress and Egress VLAN 313
 - How to Use GigaStream 319

Port Statistics and Counters	353
Monitor Port Utilization	358
Header Stripping	361
Tunnels	362
Flow Mapping®	376
About Flow Mapping®	376
Manage Maps	412
Flow Mapping® FAQ	429
Configure Active Visibility	434
GigaSECURE Security Delivery Platform	443
Flexible Inline Arrangements	450
About Flexible Inline Arrangements	451
Benefits of Flexible Inline Arrangements	453
About Flexible Inline Maps	453
Flexible Inline Arrangements—Rules and Notes	456
Visualize the Flexible Inline Arrangements Canvas	456
Configure Flexible Inline Flows	457
Troubleshoot Flexible Inline Flows	487
Backup and Restore Flexible Inline Flows	495
Inline Bypass Solutions	495
About Inline Bypass Solutions	495
Configure Inline Bypass Solutions	506
Inline Bypass Solution Examples	573
Timestamps	584
About Timestamps	584
Using Timestamps	586
Why PTP?	586
Using PTP to Timestamp Packets	588
Enabling Timestamp on a Port	591
Viewing PTP Details	591
PTP and Timestamp—Rules and Notes	600
Fabric Maps	601
Supported Topologies	601
Fabric Maps Prerequisites	604
Create Fabric Maps	607
Edit and Delete Fabric Maps	610
Prioritize Fabric Maps	611

Share Circuit ID Resource	612
Fabric Maps Statistics	612
Display Fabric Map Details	612
Filter Fabric Maps List View	613
Troubleshooting	614
Limitations of Fabric Maps	620
GigaSMART® Operations	622
Application Intelligence	623
Application Intelligence	623
GigaSMART Application Session Filtering (ASF) and Buffer ASF	647
Subscriber Intelligence	671
GigaSMART GTP Correlation	672
GigaSMART Diameter S6a Correlation	703
GigaSMART SIP/RTP Correlation	712
GigaSMART FlowVUE	728
GigaSMART GTP Whitelisting and GTP Flow Sampling	733
Display Flow Ops Reports	774
GTP Overlap Flow Sampling Maps	777
GTP Scaling	787
GTP Stateful Session Recovery	801
Traffic Intelligence	804
GigaSMART Adaptive Packet Filtering (APF)	805
GigaSMART Load Balancing	858
GigaSMART De-Duplication	878
GigaSMART MPLS Traffic Performance Enhancement	882
GigaSMART Header Stripping	885
GigaSMART Masking	906
GigaSMART NetFlow Generation	910
GigaSMART Packet Slicing	985
GigaSMART SSL Decryption for Inline and Out-of-Band Tools	989
Modules Matrix	1000
Whitelisting Policy	1001
Blacklisting Policy	1001
URL Categorization	1002
URL Look-ups and Caching	1002
Inline SSL URL categories	1003
SSL Handshake	1013

SSL Handshake Steps	1014
SSL Session, Inbound Deployment	1015
SSL Session, Outbound Deployment	1016
SSL Session Resumption	1016
SSL Session Search	1017
StartTLS	1017
Inline SSL Decryption Behavior with StartTLS	1017
Key Store	1020
Set Up Key Store Certificate Management	1020
Generate and Add a Certificate to Key Store	1021
Display Key Store Certificates	1021
Trust Store	1022
Certificate Validation	1023
Client Authentication	1024
Re-Signed Certificates	1024
Checking Certificate Revocation Status	1025
Certificate Revocation List (CRL)	1025
Online Certificate Status Protocol (OCSP)	1025
CRL and OCSP	1026
Supported Ciphers	1026
Network Phase	1030
SNI Phase	1031
Certificate Validation	1031
Cert Phase	1032
Inline SSL Decryption Port Map	1032
Enable or Disable Tool Bypass	1033
High Availability Active Standby	1033
Inline Network Group Multiple Entry	1033
Cache Persistence	1035
CPU Overload Threshold	1036
Configure the Inline SSL Monitor Mode	1037
Inline Bypass Restriction	1039
Forwarding	1039
Failover	1040
Out-of-Band and Inline Tools	1040
Service Chaining of Decrypted Traffic	1041
Limitations	1045

Enable Standalone mode for Inline SSL decryption	1045
Flow A	1050
Flow B	1050
Flow C	1051
Flow D	1052
Flow E	1053
Flow F	1054
Flow G	1055
Inline SSL Session Statistics	1061
Monitor Statistics	1061
Certificate Statistics	1063
Tunneling Operations	1086
Work with GigaSMART Operations	1131
About GigaSMART Applications	1132
GigaSMART Licensing	1133
GigaSMART Floating Licenses	1133
Access GigaSMART from GigaVUE-FM	1137
Create GigaSMART Operations – A Summary	1137
Engine Watchdog Timer in GigaSMART	1142
GigaSMART Rules and Tips	1145
Virtual Ports	1147
Differences in GigaSMART Nomenclature Between the CLI and H-VUE	1157
GigaSMART Operations in Clusters	1158
How to Combine GigaSMART Operations	1160
Supported GigaSMART Operations	1162
Order of GigaSMART Operations	1164
View GigaSMART Statistics	1164
How to Use GigaSMART Trailers	1193
GigaSMART Logs	1205
Virtual and Cloud	1207
VMware Environment	1207
Public and Private Cloud Environments	1207
GigaVUE-FM Reference	1209
Disk Size on GigaVUE-FM	1210
Increase Disk Size on a New or Existing GigaVUE-FM Installation	1211
How to Clean up Disk Space on a GigaVUE-FM Instance	1215

Data Transfer Rate Units	1216
Open Ports in GigaVUE-FM	1217
Health Status	1220
Node Health Status	1221
Port Health Status	1223
Map Health Status	1225
Flow Health Status	1229
GigaVUE-FM APIs	1232
Introduction and Concepts	1232
GigaVUE-FM API Workflows	1261
Working with GigaVUE-FM APIs	1273
Additional Sources of Information	1289
Documentation	1289
How to Download PDFs from My Gigamon	1292
Documentation Feedback	1292
Contact Technical Support	1292
Contact Sales	1293
Premium Support	1293
The Gigamon Community	1293

5.8.00 GigaVUE-FM User's Guide

Featured content:

GigaVUE® Fabric Management

GigaVUE-FM—also called GigaVUE® Fabric Manager—provides overall management for small or large Visibility Platform deployments. This section describes how to set up and use GigaVUE-FM, and reviews a broad range of management and configuration options.

Learn about:

- how GigaVUE-FM presents a centralized fabric management platform (GigaVUE-FM, [GigaVUE Nodes and Clusters](#))
- how the Core Intelligence provided by GigaVUE-OS and managed through GigaVUE-FM can be used to optimize your network traffic flow ([Traffic Filtering](#))
- how to configure GigaSMART® operations to provide network visibility and increase the efficiency of network monitoring, security, and performance tools. ([GigaSMART® Operations](#))
- how to identify and monitor application usage and filter traffic accordingly ([Application Intelligence](#))
- how the Gigamon Visibility and Analytics Fabric is made possible through GigaVUE-FM ([Fabric Maps](#))
- how to view the reporting options that GigaVUE-FM offers for the whole fabric ([Dashboard](#))

NOTE: Refer to the *GigaVUE-FM Installation, Migration, and Upgrade Guide* to get GigaVUE-FM installed and running in your network environment. Then, turn to later chapters for information on using product features.

GigaVUE-FM

This section provides an introduction the navigation for GigaVUE-FM, describes its features and functions, and summarizes the relationships between the GigaVUE-FM and the GigaVUE-OS embedded on the GigaVUE nodes.

Topics:

GigaVUE-FM Overview

GigaVUE Fabric Manager is a web-based fabric management interface that provides high-level visibility and management of both the physical and virtual traffic visibility nodes that form the Gigamon Traffic Visibility Fabric™. GigaVUE-FM can manage the following types of traffic visibility nodes:

- **Physical GigaVUE Nodes** – GigaVUE-FM manages GigaVUE G Series, TA Series, and H Series nodes, allowing for a unified workspace, while also providing an easy-to-use wizard-based approach for configuring Flow Mapping® and GigaSMART® traffic policies. For a list of GigaVUE G Series, TA Series, and H Series nodes supported for management in this release, refer to [Supported GigaVUE G Series, TA Series, and H Series Nodes](#).
- **Virtual GigaVUE Nodes** – GigaVUE-FM also extends the GigaVUE feature set into the virtual space by allowing for the discovery, configuration, and management of the new GigaVUE-VM virtual traffic visibility node. GigaVUE-VM provides powerful Flow Mapping® technology for the traffic flowing between virtual machines, allowing you to distribute cloud-based traffic to physical tool ports in the visibility fabric.

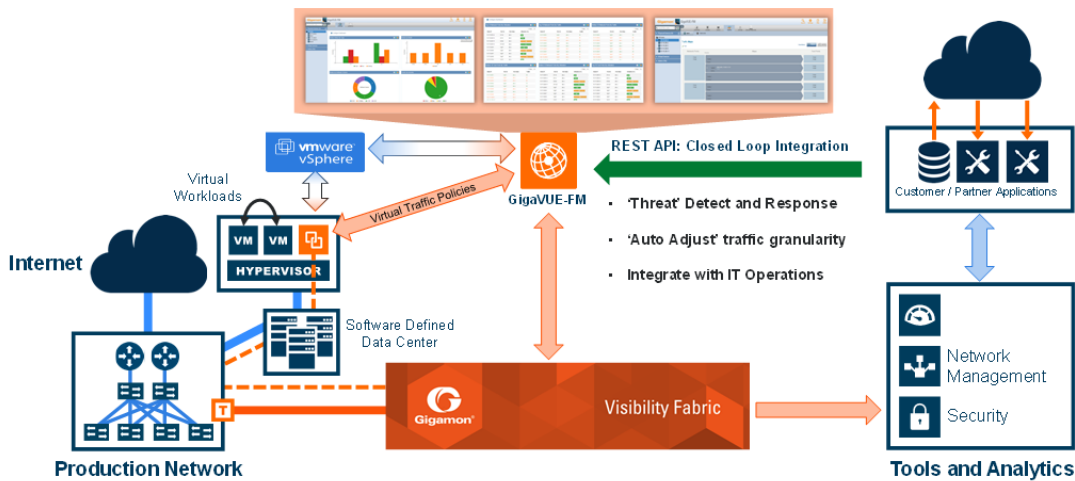


Figure 1: GigaVUE-FM Overview

GigaVUE-FM Features and Benefits

The GigaVUE-FM is a web-based management interface that provides unified access, centralized administration, and high-level visibility for all GigaVUE traffic visibility nodes in the enterprise or data center, allowing a global perspective not possible from individual nodes.

The following table summarizes the major benefits of GigaVUE-FM:

Table 1: Features and Benefits of GigaVUE-FM

Benefit	Descriptions
Centralized Management and Control	Provides centralized management, monitoring, and configuration of the physical and virtual traffic policies for the Visibility Fabric, allowing administrators to map and direct network traffic to the tools and analytics infrastructure.
Programmable APIs for Software Defined Visibility	<p>REST APIs that can be used by the traffic monitoring or IT operations management tools to perform various tasks, such as</p> <ul style="list-style-type: none"> • Improve security through better network detection, reaction, and response by automating NetFlow generation and SSL decryption so that current security appliances are not overtaxed when performing deep packet inspection. • Program the Visibility Fabric flow maps when security threats are detected. • Discover the Visibility Fabric nodes for inventory and status collection. • Performing common tasks, such as provisioning and ticketing of network port configurations. • Programmatically create, update, or delete port properties, including port-type, admin state, speed, and others. • Programmatically create, update, or delete traffic maps and GigaSMART operations.
Fabric-wide reporting	Summarized and customizable dashboards for inventory, node or cluster status, events, audit trail, and Top-N/Bottom-N port/map usage with options to export and schedule HTML or PDF reports for off-line viewing.
Advanced Monitoring	<p>Proactively monitor and troubleshoot hot spots in your Visibility Fabric:</p> <ul style="list-style-type: none"> • Top-N, Bottom-N Network/Tool Port and Map usage widgets in the dashboard • Global search across the Visibility Fabric for quick access to monitoring hot spots • Audit trail of user operations for enterprise security compliance

Benefit	Descriptions
	<ul style="list-style-type: none"> • Historical trend analysis (1 hour, 1 day, 1 week, 1 month) for port and traffic policies • Quick Views for easy access to Visibility Fabric details (node, port, traffic policies)
Scheduling capabilities	Initiates version updates to one or many fabric nodes to streamline software rollouts in an automated fashion.
Backup and Restore Capabilities	<p>Supports configuration backup and restore across multiple visibility nodes to quickly back-out changes if required due to errors or change control requirements.</p> <div data-bbox="402 625 1453 745" style="border: 1px solid #ccc; padding: 5px;"> <p>NOTE: Restoration of backed up configuration fails in G-Series. Alternatively you can download the file from GigaVUE-FM and use the GigVUE-OS-CLI to restore the configuration.</p> </div>
Improved Operational Efficiencies	<p>Minimizes resources required to configure, manage, and monitor multiple visibility nodes:</p> <ul style="list-style-type: none"> • Create/Update/Delete port properties including port-type, admin state, speed, and others • Create/Update/Delete traffic maps and GigaSMART operations
Near-Real Time Config Status	<p>Provides Near-Real Time (NRT) status of the following:</p> <ul style="list-style-type: none"> • Configuration changes performed using GigaVUE-FM APIs: Immediately reflected in the GigaVUE-FM GUI. • State changes occurring in the device (for example, oper up/down changes happening in the device): Immediately reflected in the GigaVUE-FM GUI. • Configuration changes made in the devices (for example, attributes such as 'alias' changed by the user in the device through CLI or API): Get reflected in GigaVUE-FM only after the next config sync cycle, which could be few minutes. <div data-bbox="402 1297 1453 1543" style="border: 1px solid #ccc; padding: 5px;"> <p>NOTE:</p> <ul style="list-style-type: none"> • You must enable SNMP traps in GigaVUE-FM for the NRT status updates to get reflected. However, SNMP traps are enabled by default in GigaVUE-FM. Refer to the "SNMP Traps" section in the <i>GigaVUE Administration Guide</i> for more details. • To avoid flooding of alarms, devices implement SNMP throttling. Refer to the "SNMP Throttling" section in the <i>GigaVUE Administration Guide</i>. </div>

Supported GigaVUE G Series, TA Series, and H Series Nodes

GigaVUE-FM provides support for GigaVUE G Series, TA Series, and H Series nodes through the administration of physical nodes (Device Management and Configuration Management) feature.

Device Management

During the initial start up of GigaVUE-FM, it performs a *Discover* on GigaVUE G Series, TA Series, and H Series nodes listed in [Table 2: GigaVUE-FM Managed GigaVUE Nodes and Software Versions](#).

Table 2: GigaVUE-FM Managed GigaVUE Nodes and Software Versions

GigaVUE Series	Node	Supported Releases for GigaVUE-FM Management
GigaVUE H Series Nodes	GigaVUE-HB1	v4.8.xx, v5.0.xx, v5.1.xx, v5.2.xx, v5.3.xx, v5.4.xx, v5.5.xx, 5.6.xx
	GigaVUE-HC1	v4.8.xx, v5.0.xx, v5.1.xx, v5.2.xx, v5.3.xx, v5.4.xx, v5.5.xx, v5.6.xx, v5.7.xx, v5.8.xx, v5.9.xx
	GigaVUE-HC2	v4.7.xx, v4.8.xx, v5.0.xx, v5.1.xx, v5.2.xx, v5.3.xx, v5.4.xx, v5.5.xx, v5.6.xx, v5.7.xx, v5.8.xx, v5.9.xx
	GigaVUE-HC2 with HC CCv2 Control Card	v4.7.xx, v4.8.xx, v5.0.xx, v5.1.xx, v5.2.xx, v5.3.xx, v5.4.xx, v5.5.xx, v5.6.xx, v5.7.xx, v5.8.xx, v5.9.xx
	GigaVUE-HC3	v5.0.00, v5.1.xx, v5.2.xx, v5.3.xx, v5.4.xx, v5.5.xx, 5.6.xx, v5.7.xx, v5.8.xx, v5.9.xx
GigaVUE TA Series Nodes	GigaVUE-TA1	v4.8.xx, v5.0.xx, v5.1.xx, v5.2.xx, v5.3.xx, v5.4.xx, v5.5.xx, 5.6.xx
	GigaVUE-TA10	v4.7.xx, v4.8.xx, v5.0.xx, v5.1.xx, v5.2.xx, v5.3.xx, v5.4.xx, v5.5.xx, v5.6.xx, v5.7.xx, v5.8.xx, v5.9.xx
	GigaVUE-TA40	v4.7.xx, v4.8.xx, v5.0.xx, v5.1.xx, v5.2.xx, v5.3.xx, v5.4.xx, v5.5.xx, v5.6.xx, v5.7.xx, v5.8.xx, v5.9.xx

GigaVUE Series	Node	Supported Releases for GigaVUE-FM Management
	GigaVUE-TA100	v4.7.xx, v4.8.xx, v5.0.xx, v5.1.xx, v5.2.xx, v5.3.xx, v5.4.xx, v5.5.xx, v5.6.xx, v5.7.xx, v5.8.xx, v5.9.xx
	GigaVUE-TA100-CXP	v4.8.01, v5.0.xx, v5.1.xx, v5.2.xx, v5.3.xx, v5.4.xx, v5.5.xx, v5.6.xx, v5.7.xx, v5.8.xx, v5.9.xx
	GigaVUE-TA200	v5.3.xx, v5.4.xx, v5.5.xx, v5.6.xx, v5.7.xx, v5.8.xx, v5.9.xx

NOTE: Although GigaVUE-FM may recognize earlier versions of GigaVUE G Series, GigaVUE-TA1 and H Series nodes, the versions listed in [Table 2: GigaVUE-FM Managed GigaVUE Nodes and Software Versions](#) are the officially supported versions. Earlier versions are not managed by GigaVUE-FM.

Configuration Management

GigaVUE-FM allows you to perform configuration tasks on GigaVUE H Series and TA Series nodes only. It supports the versions listed in [Table 3: GigaVUE Nodes and Software Versions Configurable by GigaVUE-FM](#).

Table 3: GigaVUE Nodes and Software Versions Configurable by GigaVUE-FM

GigaVUE Series	Node	Supported Releases for GigaVUE-FM Management
GigaVUE H Series Nodes	GigaVUE-HB1	v4.8.xx, v5.0.xx, v5.1.xx, v5.2.xx, v5.3.xx, v5.4.xx, v5.5.xx, 5.6.xx
	GigaVUE-HC1	v4.8.xx, v5.0.xx, v5.1.xx, v5.2.xx, v5.3.xx, v5.4.xx, v5.5.xx, v5.6.xx, v5.7.xx, v5.8.xx, v5.9.xx
	GigaVUE-HC3	v5.0.00, v5.1.xx, v5.2.xx, v5.3.xx, v5.4.xx, v5.5.xx, v5.6.xx, v5.7.xx, v5.8xx, v5.9.xx
	GigaVUE-HC2	v4.7.xx, v4.8.xx, v5.0.xx, v5.1.xx, v5.2.xx, v5.3.xx, v5.4.xx, v5.5.xx, v5.6.xx, v5.7.xx, v5.8xx, v5.9.xx
	GigaVUE-HC2 with HC CCv2 Control Card	v4.7.xx, v4.8.xx, v5.0.xx, v5.1.xx, v5.2.xx, v5.3.xx, v5.4.xx, v5.5.xx, v5.6.xx, v5.7.xx

GigaVUE Series	Node	Supported Releases for GigaVUE-FM Management
		,v5.8xx, v5.9.xx
GigaVUE TA Series Nodes	GigaVUE-TA1	v4.8.xx, v5.0.xx, v5.1.xx, v5.2.xx, v5.3.xx, v5.4.xx, v5.5.xx, 5.6.xx
	GigaVUE-TA10	v4.7.xx, v4.8.xx, v5.0.xx, v5.1.xx, v5.2.xx, v5.3.xx, v5.4.xx, v5.5.xx, v5.6.xx, v5.7.xx, v5.8xx, v5.9.xx
	GigaVUE-TA40	v4.7.xx, 4.8.xx, v5.0.xx, v5, 5.6.xx.1.xx, v5.2.xx, v5.3.xx, v5.4.xx, v5.5.xx, v5.6.xx, v5.7.xx, v5.8xx, v5.9.xx
	GigaVUE-TA100	v4.8.xx, v5.0.xx, v5.1.xx, v5.2.xx, v5.3.xx, v5.4.xx, v5.5.xx, v5.6.xx, v5.7.xx, v5.8xx, v5.9.xx
	GigaVUE-TA100-CXP	v4.8.01, v5.0.xx, v5.1.xx, v5.2.xx, v5.3.xx, v5.4.xx, v5.5.xx, v 5.6.xx, v5.7.xx, v5.8xx, v5.9.xx
	GigaVUE-TA200	v5.3.xx, v5.4.xx, v5.5.xx, v5.6.xx, v5.7.xx, v5.8xx, v5.9.xx

How to enable Web Server for Node Management

GigaVUE-FM can only discover and manage nodes with their web servers enabled and operating on the default HTTP port of 80. The request from Port 80 is immediately redirected to port 443 (HTTPS) for secure connections over SSL.

Get Started with GigaVUE-FM

This section provides an overview of GigaVUE-FM interface. It also provides information about table customization and search features available in GigaVUE FM.

It includes the following major sections:

- [Log In to GigaVUE-FM](#)
- [GigaVUE-FM Navigation](#)
- [Configure a Custom Banner](#)
- [Quick Views](#)
- [Return to the Dashboard](#)
- [Table View Customization](#)

- [Notifications Panel](#)
- [How to Add the GigaVUE-FM Instance Name](#)
- [How to Search in GigaVUE-FM](#)

Log In to GigaVUE-FM

The GigaVUE-FM login page provides information about the security policy login banner beside the username and password fields. The login banner is customizable. For more information about configuring a custom banner, refer to [Configure a Custom Banner](#).

GigaVUE-FM is preconfigured with one user with the `fm_super_admin` role assigned (username - admin, password - admin123A!). The default password (admin123A!) on the admin account must be changed to a non-default password (as it is no longer allowed to have the default password).

Log Out of GigaVUE-FM

To logout of GigaVUE-FM, click the **Admin** drop-down list on the top right of GigaVUE-FM and select **Logout**.

GigaVUE-FM Navigation

The navigation in GigaVUE-FM provides improved usability and customer experience.

Dashboard

When you first login to GigaVUE-FM, the Dashboard - Physical & Virtual page is displayed by default. You can navigate to Health Monitor Dashboards from the left navigation pane. Refer to [New GigaVUE-FM GUI in 5.8](#).

[Table 4: Summary of Dashboard Navigation](#) provides descriptions of the top navigation bar and the left navigation pane in GigaVUE-FM.

Table 4: Summary of Dashboard Navigation

Top Navigation Bar	Left Navigation Pane
Dashboard	Physical & Virtual —Displays the informational widgets for the physical and Virtual nodes.
	Health Monitor—Displays information about GigaVUE-FM such as CPU usage, amount of storage used and available.

Top Navigation Bar	Left Navigation Pane
Profiles	Allows you to create and view the profiles. A profile allows you to create a customized dashboard to monitor the physical and virtual nodes.

Physical

Click Physical to view the physical nodes and clusters managed by GigaVUE-FM. Under Physical, you can add and delete physical nodes, create and manage clusters, perform image upgrades, take backups, and restore and reboot images.

[Table 5: Summary of Physical](#) provides descriptions of the Physical page in GigaVUE-FM:

Table 5: Summary of Physical

Top Navigation Bar	Left Navigation Pane
Physical	Physical Nodes—Provides information about the nodes and clusters managed by GigaVUE-FM.
	Topology—Provides graphical view of the nodes and clusters currently managed by GigaVUE-FM. It also displays the nodes and clusters that are discoverable. For example, the neighbor nodes can be auto-discovered using the Link Layer Discovery Protocol (LLDP), Cisco Discovery Protocol (CDP) and Gigamon Discovery Protocol (GDP).
	Flows—Provides the ability to view the traffic flowing from a network port that receives the traffic from a network TAP to the tool port that sends the traffic to the tools.
	Tools—Allows you to add tools and connect to your devices.
	Fabric Maps—flow maps simplify how you create flow mapping across multiple clusters. Using GigaVUE-FM, you can create and manage flow maps.

Top Navigation Bar	Left Navigation Pane
	<p>Inline Flows—Allows you to configure flexible inline flows.</p>
	<p>Events—Displays all notifiable events pertaining to physical nodes. For example, you can view user authentication failure, high CPU utilization, node discovery, device configuration state changes, and many others. You can filter and manage the Alarm/Event logs from this page.</p>
	<p>Audit Logs—Displays the tasks pertaining to physical nodes managed by GigaVUE-FM. You can filter and manage the audit logs from this page.</p>

Virtual

Click **Virtual** to view the virtual nodes managed by GigaVUE-FM. Under Virtual, you can configure GigaVUE-VMs in different virtual environments such as VMware ESXi, VMware NSX-V, VMware NSX-T.

Table 6: Summary of Virtual provides descriptions of the Virtual page in GigaVUE-FM:

Table 6: Summary of Virtual

Top Navigation Bar	Left Navigation Pane
Virtual	
	VMware vCenter
	Virtual Nodes—Displays information about all the deployed GigaVUE-VMs and their status.
	Virtual Maps—Displays information about configuring the virtual maps on the virtual nodes for VMware vCenter.
	Management—Allows you to connect to virtual center, deploy GigaVUE-VMs to multiple ESXi hosts, and configure tunnel endpoints.
	VMware vCenter/NSX-V and VMware vCenter/NSX-T
	Virtual Nodes—Displays information about all the deployed GigaVUE-VMs in the NSX environment and their statuses.
	Virtual Maps—Displays information about configuring the virtual maps on the virtual nodes for VMware NSX.
	Management—Allows you to connect to virtual center, deploy GigaVUE-VMs to multiple ESXi hosts, and configure tunnel endpoints.
	All VIRTUAL
	Events—Displays all notifiable events pertaining to physical nodes. For example, you can view user authentication failure, high CPU utilization, node discovery, device configuration state changes, and many others. You can filter and manage the Alarm/Event logs from this page.
	Audit Logs—Displays the tasks pertaining to virtual nodes managed by GigaVUE-FM. You can filter and manage the audit logs from this page.

Cloud

Click **Cloud** to configure the components of the Gigamon Visibility Platform for Amazon Web Services (AWS), Azure, OpenStack, Kubernetes, AnyCloud and Nutanix.

Table 7: Summary of Cloud provides descriptions of the Virtual page in GigaVUE-FM:

Table 7: Summary of Cloud

Top Navigation Bar	Left Navigation Pane
Cloud	
	<p>AWS</p> <p>For documentation, refer to <i>GigaVUE Cloud Suite for AWS Configuration Guide</i>, available in the Customer Portal.</p>
	<p>Azure</p> <p>For documentation, refer to <i>GigaVUE Cloud Suite for Azure Configuration Guide</i>, available in the Customer Portal.</p>
	<p>OpenStack</p> <p>For documentation, refer to <i>GigaVUE Cloud Suite for OpenStack Configuration Guide</i>, available in the Customer Portal.</p>
	<p>Kubernetes</p> <p>For documentation, refer to <i>GigaVUE Cloud Suite for Kubernetes Container Visibility Configuration Guide</i>, available in the Customer Portal.</p>
	<p>Nutanix</p> <p>For documentation, refer to <i>GigaVUE Cloud Suite for Nutanix Configuration Guide</i>, available in the Customer Portal.</p>
	<p>AnyClouds</p> <p>For documentation, refer to <i>GigaVUE Cloud Suite for AnyCloud Configuration Guide</i>, available in the Customer Portal.</p>
	<p>CLOUD</p>
	<p>Events—Displays all notifiable events pertaining to the cloud platforms. For example, you can view AWS connection status changed, AWS license expiry, and others.</p>
	<p>Audit Logs—Displays the tasks pertaining to the cloud platforms. You can filter and manage the audit logs from this page.</p>

Administration


Click  on the top navigation bar. The Administration page appears.

Table 7: Summary of Cloud provides descriptions of the Administration page in GigaVUE-FM:

Table 8: Summary of Administration

Top Navigation Bar	Left Navigation Pane
Administration	
	All Events—Displays the events for Physical, Virtual, and Cloud.
	All Audit Logs—Displays the audit logs for Physical, Virtual, and Cloud. You can easily filter and manage the audit logs.
	Tasks—Displays the admin and scheduled tasks. These pages are used to add and manage scheduled events such as image upgrades.
	Reports—Allows you to generate visibility fabric performance reports, visibility fabric node details report, GigaVUE-VM report, visibility fabric inventory report, and so on using various templates. The reports can be downloaded in HTML or PDF format.
	Authentication—Allows you to configure authentication and authorization settings for GigaVUE-FM.
	Tags—Allows you to create a user-defined tag that can be associated to clusters, ports, port groups, maps and GigaSMART groups.
	System—Allows you to configure licenses, set up preferences, node credentials, backup and image file storage location, notifications, email servers, storage management, and so on.

Configure a Custom Banner

It is recommended to configure a pre-login banner which states the security policy of your company or organization. The banner appears on the login screen before the users log into GigaVUE-FM.

Only the users with `fm_admin` and `fm_super_admin` role assigned can view and configure the custom banner.

To configure the custom banner:

1. Click on the top navigation bar and select **Systems > Preferences**.
2. Click **Edit** and the Edit Preferences page appears.
3. Enter the custom banner message in the **Login Banner** text box.
4. Click **Save**.

Quick Views

A quick view provides easy access to Visibility Fabric details such as nodes, ports, and traffic policies. In GigaVUE-FM, you can click on items such as port ID, map alias, port error counts, and so on, and get detailed information about the selected item.

Return to the Dashboard

At any time, to return back to the Dashboard, click the GigaVUE-FM text on the top left of GigaVUE-FM. Refer to [Dashboard](#). By default, the Physical & Virtual Dashboard page is displayed.

Table View Customization

GigaVUE-FM enables you to customize the appearance of tables. You can choose the columns you want to show and hide in the table. You can also choose the order in which you want to view the columns in the table.

To customize the columns:

1. Click the '+' icon on the top-right edge of the table.

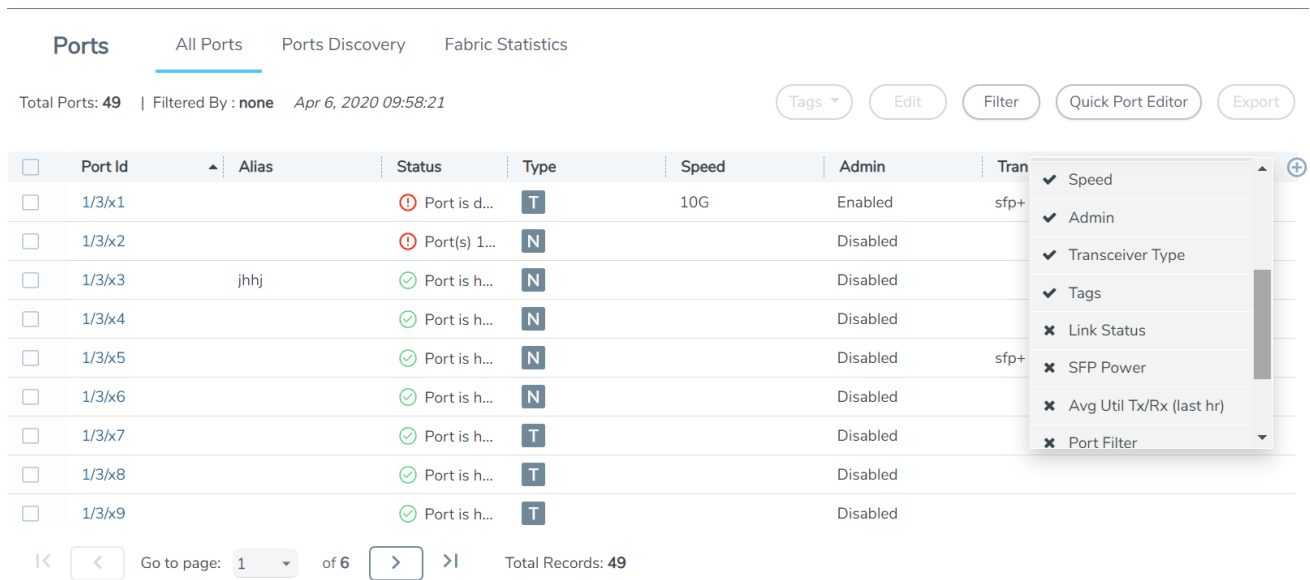


Figure 2: Table menu to configure columns

2. Click on a column name to change the show/hide setting. A check mark indicates the columns to show and an X indicates the columns to hide.

3. To rearrange the columns in the table, select a column heading and drag it to the new location. Your customizations are automatically saved.
4. Click on 'Reset columns to default' to reset the columns to the default view.

NOTE: The customized column settings are preserved for the user profile. When you logout and log back in, the tables display the same customized columns.

The pagination option on the bottom-right corner of the page allows you to scroll through long lists of data that span across multiple pages. You can also jump to a specific page by clicking the page number. Each page can show up to 100 rows of data per view.

GigaVUE-FM allows you to download the tables in a CSV file format using the **Download all data as csv** option.

Note: The bulk CSV download window does not generate the correct CSV file.

Notifications Panel

The Notifications icon in the top navigation bar will display a number if there are any system alerts. Immediate alerts appear the left side of the page as individual pop-ups.

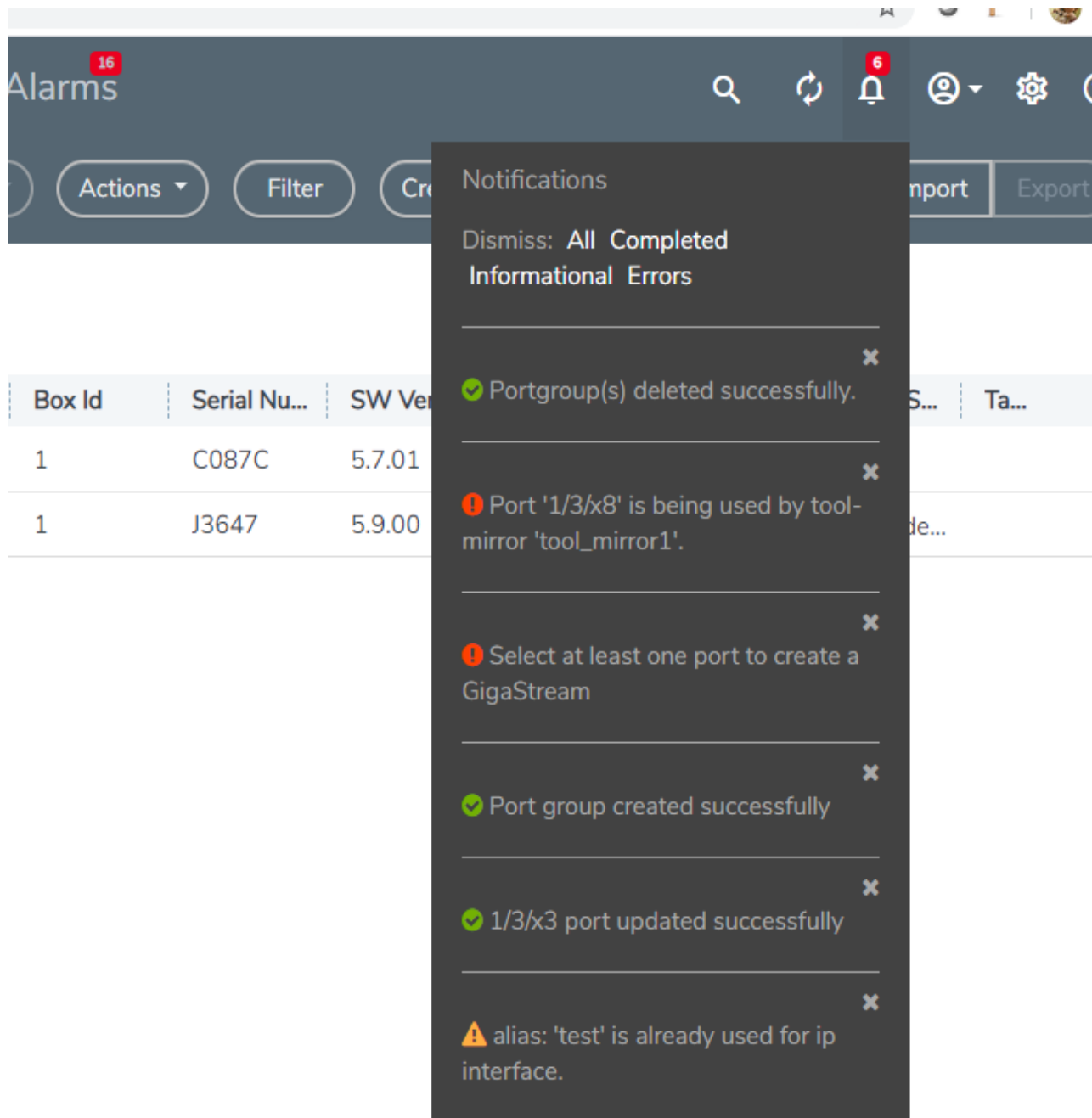


Figure 3: Pop-up messages

Long-term Notifications

Click the Notifications icon to display a Notifications Panel listing long-term alert messages. If the list is long, a scroll bar appears on the left so you can scroll through the list.

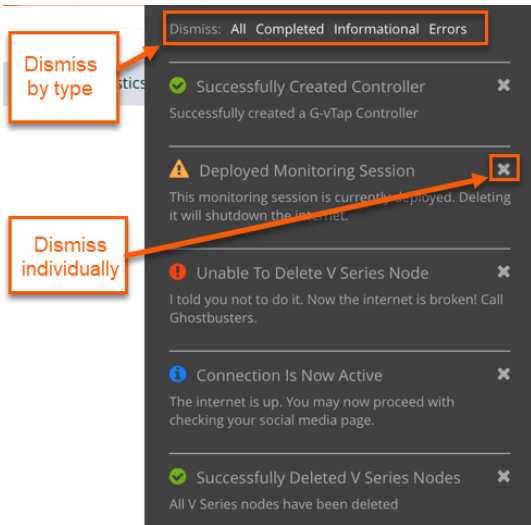







Figure 4: Long-term messages

Messages are updated as more information is received from packets. You can dismiss individual messages or by type.

Notification Type Icons

Notification messages include a summary and a notification-type icon indicating the severity level of the alert. Some notifications have titles as well.

	Process Completed (green circle with a check mark)
	Warning (yellow triangle with an exclamation point)
	Error (red circle with an exclamation point)
	Information (blue circle with an "i")
	Alert being processed (gray spinner)

How to Add the GigaVUE-FM Instance Name

The default name displayed on a GigaVUE-FM instance tab is GigaVUE-FM. Refer to [Figure 5: Default Tab Name](#) .

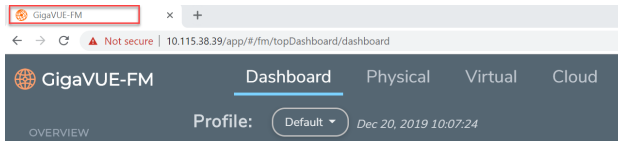



Figure 5: Default Tab Name

When you have multiple GigaVUE-FM Instances running in your system, it becomes difficult to differentiate the instances and switch between tabs. Starting in software version 5.1, GigaVUE-FM provides the ability to customize the GigaVUE-FM instance name.

To customize the GigaVUE-FM instance name:

1. Click  on the top navigation bar.
2. On the left navigation pane, go to **System > Preferences**.
3. Click **Edit**.
4. In the **FM Instance Name** box, enter a name for the GigaVUE-FM instance.
5. Click **Save**.

The customized GigaVUE-FM instance name is displayed instantly in the tab. The Instance name is also displayed beside the GigaVUE-FM logo.

How to Search in GigaVUE-FM

When searching for items, GigaVUE-FM performs a full search across multiple categories and displays the categories as part of the results. A Filter option is also available, which displays as a quick view, making it possible to quickly refine the search results.

GigaVUE-FM has an Elastic Search feature that allows you to search for information in GigaVUE-FM as well all the devices and device configurations managed by GigaVUE-FM. Essentially, if it is part of the GigaVUE-FM UI or managed by GigaVUE-FM, you can search for items based on keywords because almost all items are indexed for elastic search. The search feature allows you to search for items across the following:

- Maps
- Roles and Users
- GigaSMART
 - GigaSMART Operations
 - GigaSMART Groups
 - Virtual Ports

- NetFlow/IPFIX Generation
- SSL Decryption
- GTP Whitelists
- Application Session Filtering (ASF)
- Ports
 - Port Groups
 - Port Pairs
 - Tool Mirrors
 - Stack Links
 - Tunnel Endpoints
 - IP Interfaces
 - Circuit Tunnels
 - GigaStreams
- Chassis and port inventory
- Node Clusters
- VMs
- IP, DNS, and MAC address

The following are not currently searchable: audit logs, events, NetFlow data, RBAC, IP ranges, or statistics.

Categories are another important component of Elastic Search. When you provide a keyword, the search system displays the matching category or categories related to the keyword search. This provides an automatic filtering of the keyword, helping to narrow your search. Some of the general categories are:

- Cluster
- GigaSMART
- Inline Bypass
- Maps
- NSX-V
- Ports
- Users
- VMware

You can refine the search categories by using the Filter feature (refer to [Filtering Search Results](#)) to further narrow the search results. For example, if the search keyword falls into the GigaSMART category, you can narrow the search further to NetFlow Records.

Performing a Search

To find an item in GigaVUE-FM, do the following:

1. Click the **Search** icon in the GigaVUE-FM top menu to open the Keyword field.
2. Type a keyword in the text field.

As you enter the keyword, the system displays the categories in which the keyword appears and the total matches in that category along with the specific instances. For example, as shown in [Figure 6: GigaVUE-FM Search](#), you start to enter an IP address. The search shows that 10.115 occurs in the Cluster category 29 times, Ports 1 time, and IP Interfaces 2 times.

NOTE: You can type up to 128 characters in the **Keyword** field. This is because you cannot create a component with alias more than 128 characters (Map aliases, Port aliases and other such aliases).

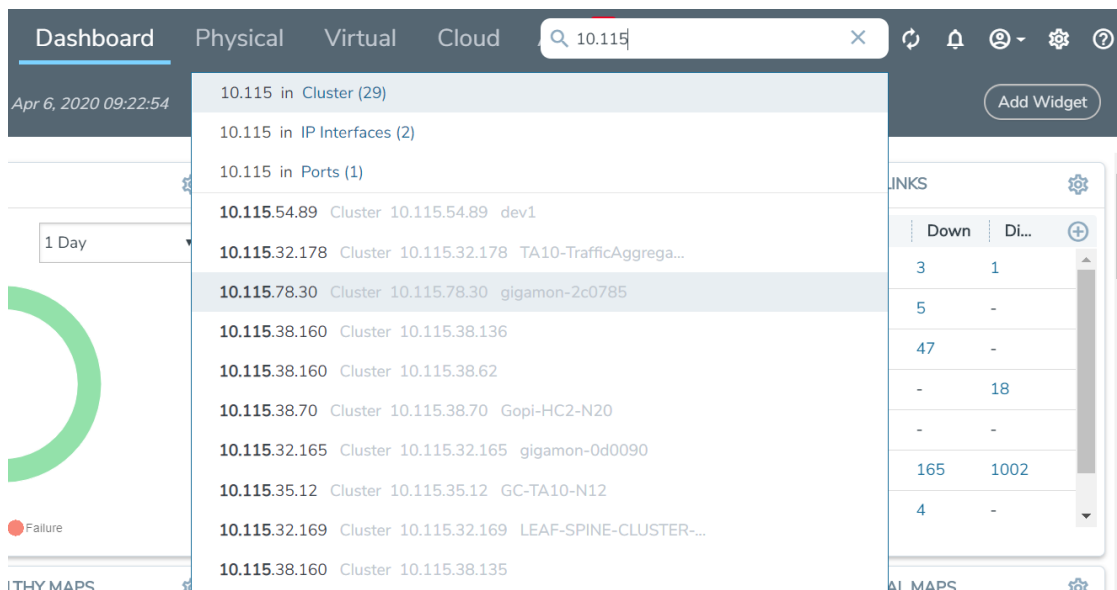


Figure 6: GigaVUE-FM Search

3. Once you are done entering the keyword, you can scroll through the list by using the up and down keys on the keyboard. Select an item by pressing the Enter key.
 - Selecting a category, displays all the results in that category, using the category as a filter. You can further refine the results by clicking the **Filter** button. For details on filtering, refer to [Filtering Search Results](#).
 - Selecting a specific result opens the page for that item.


If the search result is a cluster or standalone node, clicking the results takes you to the Overview page of that node and the Keywords field displays the node's ID as shown in the following figure. When the node ID is displayed in the Keywords field, it indicates that the scope of searches is narrowed to the current node or cluster.

Search Examples

This section provides few examples to show how to use the elastic search feature. The examples cover the following:

- [Searching Maps](#)
- [Searching for Roles and Users](#)
- [Searching Ports](#)

Searching Maps

You can search for maps based on the map alias, IP address associated with maps, MAC address, port status and so on. Click on the **Filter by Cluster** icon  in the search results page to refine the search results based on the cluster ID.

This section provides several examples of searching Maps:

- [Example 1: Searching for a Map by Alias](#)
- [Example 2: Searching for a Map with an IP Address](#)
- [Example 3: Searching for a Map with a MAC Address](#)
- [Example 4: Searching for Maps with Down Ports](#)

Example 1: Searching for a Map by Alias

In this example, you are looking for a map where you remember the map's alias but are not sure which node or cluster it is on.

1. Click the Search icon in the GigaVUE-FM header to open the Keyword field and start typing the map alias. In this example, Up.

As you type the search displays the categories and items that match the keyword. [Figure 7: Searching by Map Alias](#) shows the search results and you can see that the map with Alias Up is on node 10.60.94.73 without typing the entire string.

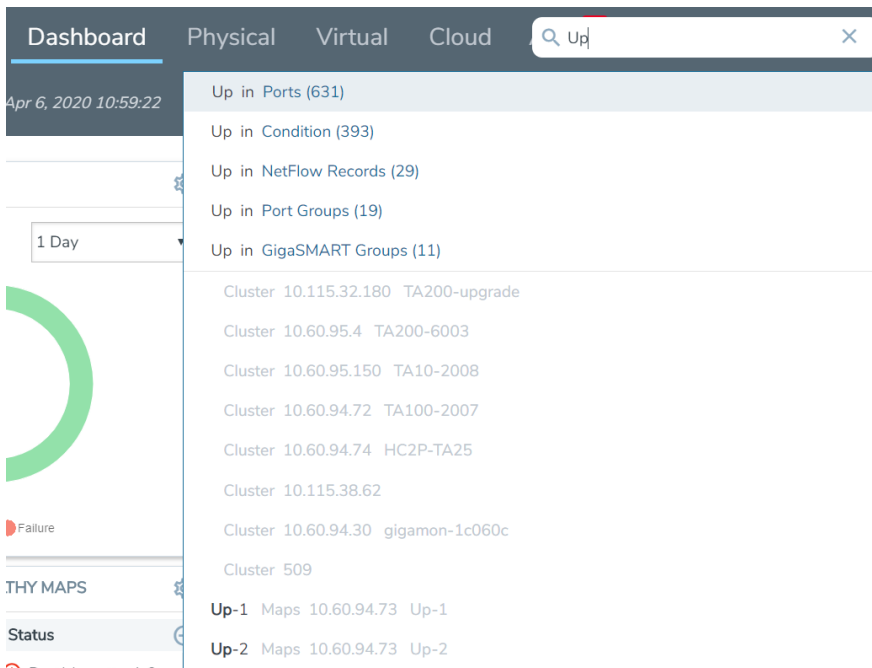


Figure 7: Searching by Map Alias

2. In the search results, click on Up-1.

GigaVUE-FM opens the Map page as shown in [Figure 8: Map Page](#).

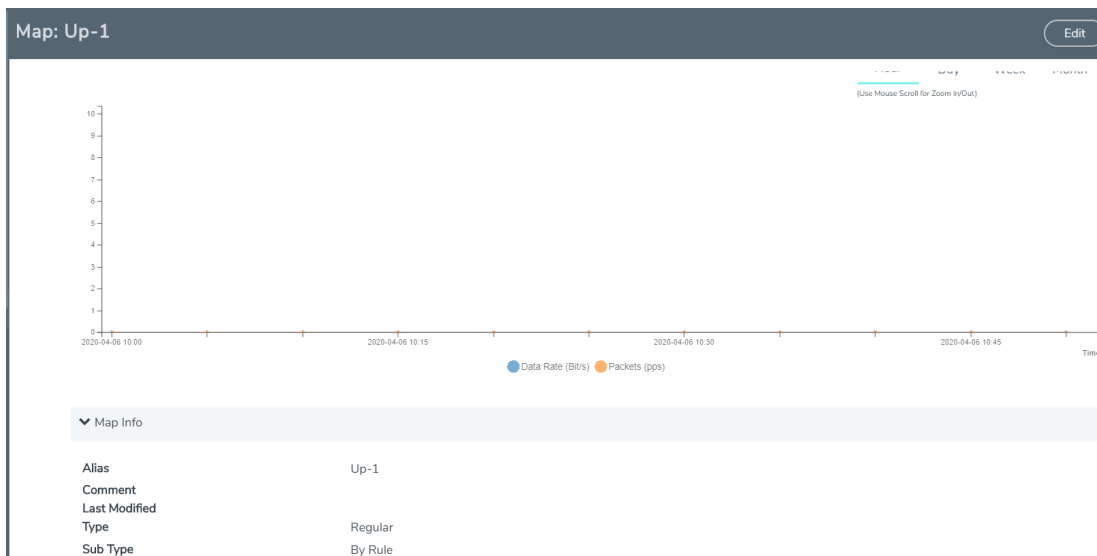


Figure 8: Map Page

Example 2: Searching for a Map with an IP Address

In this example, you are searching for a map or maps that contain a specific IP address.

1. Click the Search icon in the GigaVUE-FM header to open the Keyword field and start typing an IP address. In this example, the IP address is 10.60.94.73.

As you type the search displays the categories and items that match the keyword. [Figure 9: Search for IP Address](#) shows the search results.

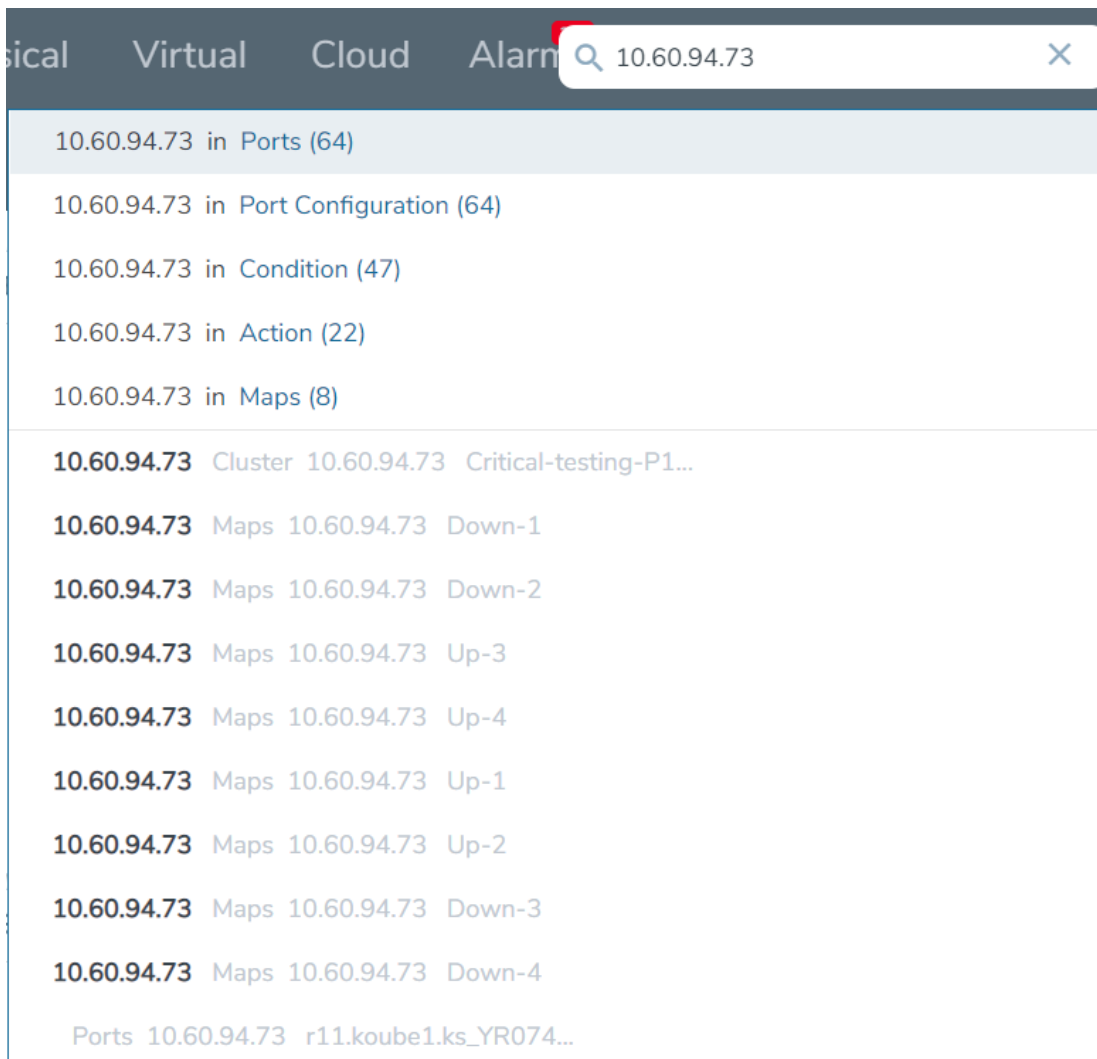


Figure 9: Search for IP Address

2. Click on Maps in the categories section of the search results.

The Filter page opens. [Figure 10: Search Result Filter Page](#) shows the results with maps that contain the IP address. In this scenario, the item of interest is Down-1, so you click on the cluster name.

Search Results for "10.60.94.73" Filter						
Filtered By : none ▼						
Alias	Cluster ID/Device IP	Type	Source ports	Destination Ports	Map Status	Number of Rules
Down-1	10.60.94.73	regular	1/1/x1,1/1/x2	1/1/x57	⊘ Port(s) r11.koube1...	28
Down-2	10.60.94.73	regular	1/1/x3,1/1/x4	1/1/x59	⊙ Map is Healthy	28
Up-3	10.60.94.73	regular	1/1/x29,1/1/x30,1/1/x3...	1/1/x62	⊘ Multiple ports are L...	28
Up-4	10.60.94.73	regular	1/1/x39,1/1/x40,1/1/x4...	1/1/x64	⊘ Multiple ports are L...	28
Up-1	10.60.94.73	regular	1/1/x9,1/1/x10,1/1/x11...	1/1/x58	⊘ Multiple ports are L...	28
Up-2	10.60.94.73	regular	1/1/x19,1/1/x20,1/1/x2...	1/1/x60	⊘ Multiple ports are L...	28
Down-3	10.60.94.73	regular	1/1/x5,1/1/x6	1/1/x61	⊙ Map is Healthy	28
Down-4	10.60.94.73	regular	1/1/x7,1/1/x8	1/1/x63	⊙ Map is Healthy	28

Figure 10: Search Result Filter Page

A Map quick view opens, showing the information for the map.

Example 3: Searching for a Map with a MAC Address

In this example, you are searching for a map or maps that contain a specific MAC address.

1. Click the **Search** icon in the GigaVUE-FM header to open the Keyword field and start typing an IP address. In this example, the IP address is 11:11:11:11:11.

After entering the MAC address in the Keyword field, only one map is found as shown in [Figure 11: Search for MAC Address](#).



Figure 11: Search for MAC Address

2. Click on the result with the map named MacSrcMap to view the map details.

Example 4: Searching for Maps with Down Ports

In this example, you are looking for maps that have a port that is in the "down" state.

1. Click the Search icon in the GigaVUE-FM header to open the Keyword field and type down.

As shown in [Figure 12: Search Results for down Keyword](#), the keyword occurs in several categories.

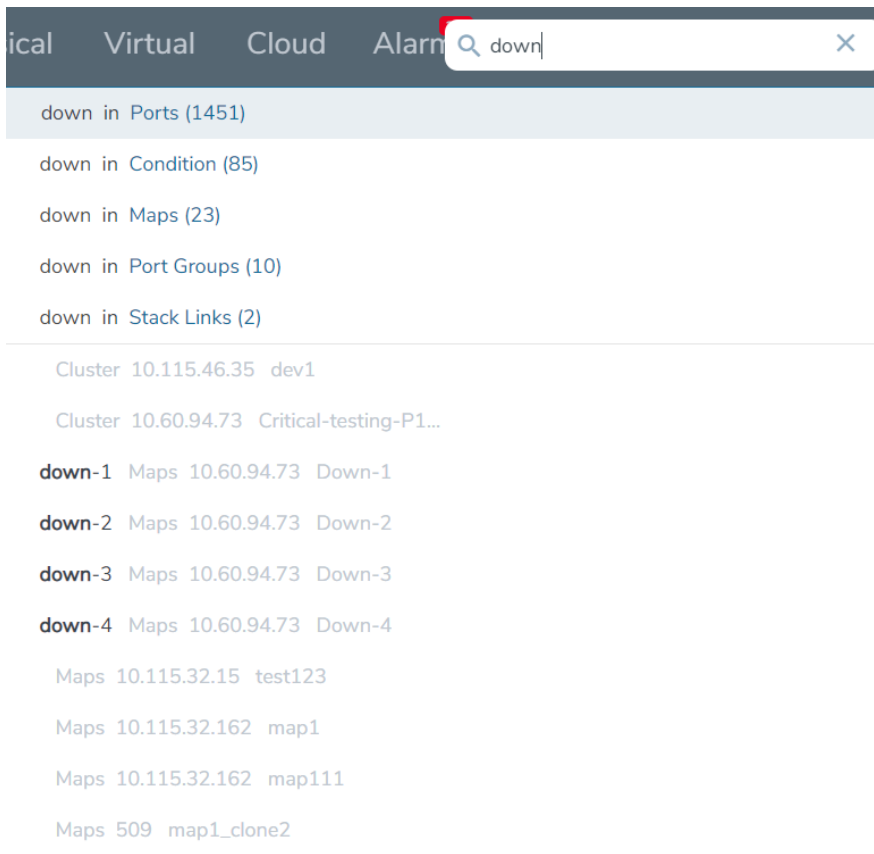


Figure 12: Search Results for down Keyword

2. Because you are searching for Maps, you click on the Maps category.

Searching for Roles and Users

This section provides examples of searching for a role and for a user:

- [Example 1: Searching for Monitor Role](#)
- [Example 2: Searching for a User](#)

Example 1: Searching for Monitor Role

In this example, you are looking for where the fm_User role is applied.

1. Click the Search icon in the GigaVUE-FM header to open the Keyword field and type Monitor.
As shown in [Figure 13: Categories for Monitor.](#), the keyword occurs in the several categories.

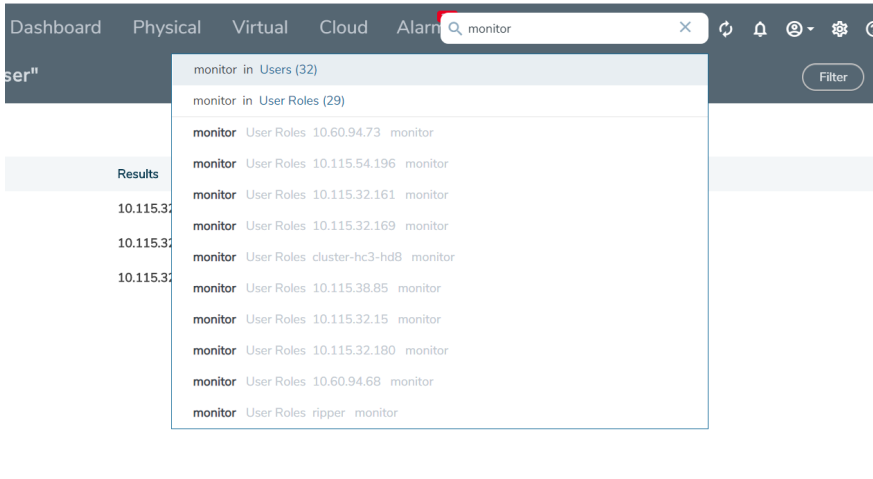


Figure 13: Categories for Monitor.

2. Select the User Roles category. The search results shows the nodes where the Monitor role is used.

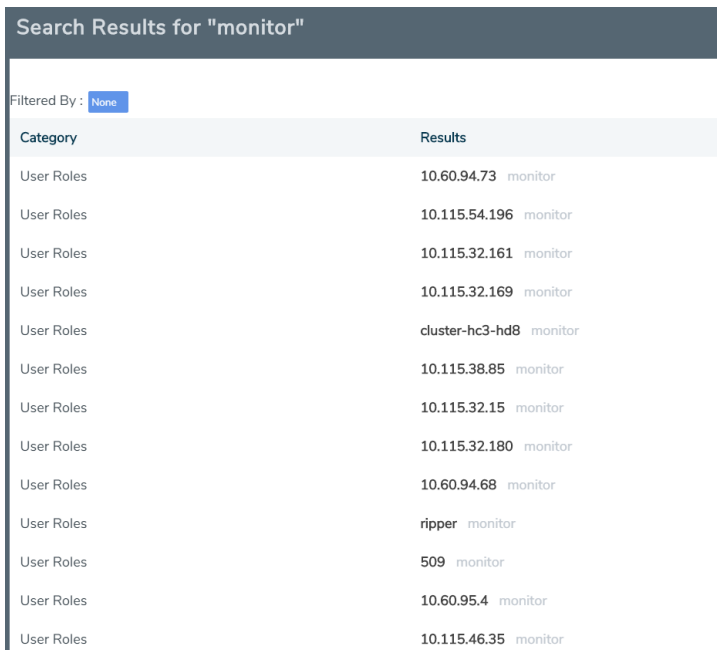


Figure 14: Search Results for Monitor.

3. From the search results, drill down further by selecting one of the results.

GigaVUE-FM takes you to the User Setup page for the selected cluster as shown in [Figure 15: Role From Search Result](#) and indicates in the Keywords field that further searches are restricted to the cluster.

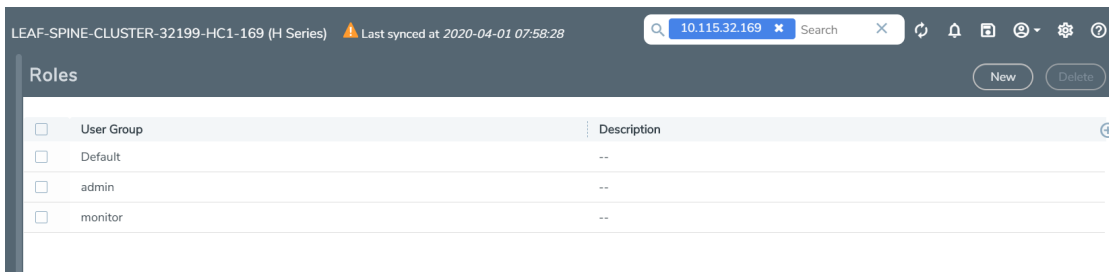
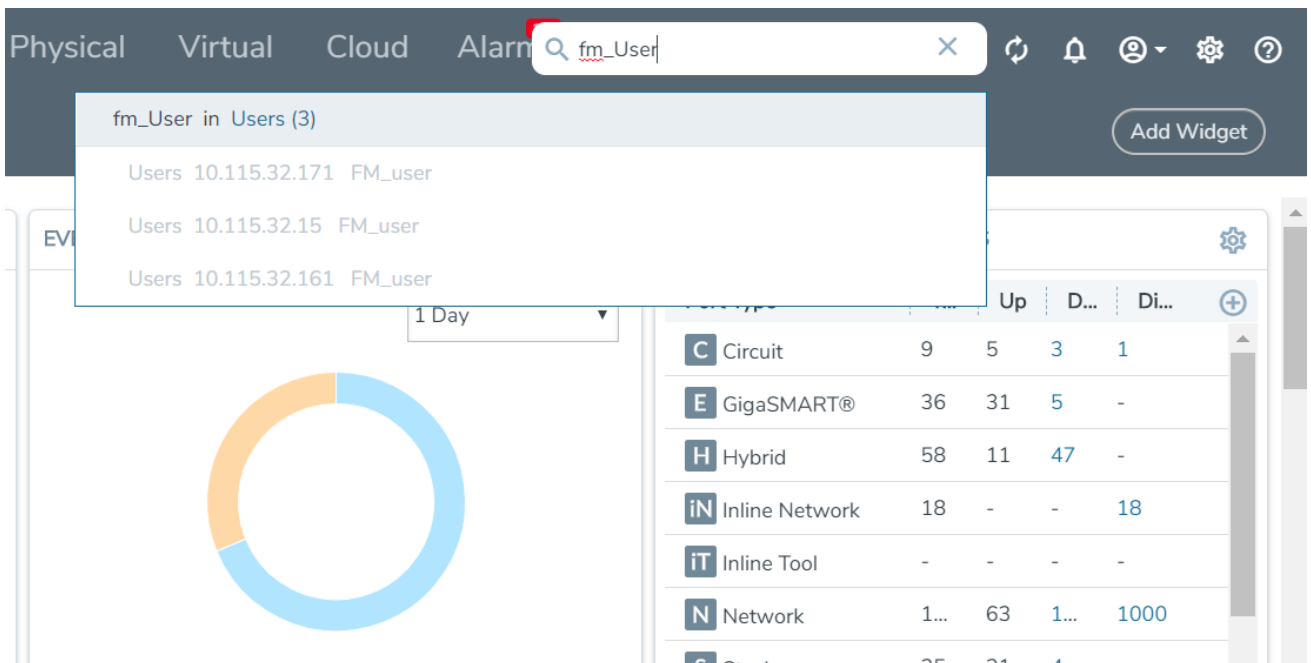


Figure 15: Role From Search Result

Example 2: Searching for a User

In this example, you are looking for a specific user.

1. Click the Search icon in the GigaVUE-FM header to open the Keyword field and type the user name for the user. In this example, the user is *fm_User*.



2. Click on *fm_User* in the categories and items list. The User page on the node with the *fm_User* opens a shown in the following figure. The Keywords field also indicates further searches are restricted to the current node.

hc1-171 (H Series) Last synced at 2020-04-06 15:33:27

10.115.32.171 Search


User Setup

Add Edit Delete

<input type="checkbox"/>	Full Name	Username	User Group	Enabled	Account Status
<input type="checkbox"/>	-	FM_user	monitor	true	Password Set
<input type="checkbox"/>	System Administrator	admin	admin	true	Password Set
<input type="checkbox"/>	-	gigatest	admin	true	Password Set
<input type="checkbox"/>	-	imre	admin	true	Password Set
<input type="checkbox"/>	System Monitor	monitor	monitor	true	No Password Required For Login
<input type="checkbox"/>	System Operator	operator	-	true	Account Locked Out

Searching Ports

NOTE: You can search for ports based on the port id, port alias, cluster ID/Device IP and so on. You can also view the neighboring ports information from the port search results page.

Click on the **Filter by Cluster** icon  in the search results page to refine the search results based on the cluster ID.

This section provides few examples related to searching for ports:

- [Example 1: Searching for Down Ports](#)
- [Example 2: Searching for Port Details of Devices Managed by GigaVUE-FM](#)

Example 1: Searching for Down Ports

In this example, you are searching for a particular port by its ID. This example also shows how to combine keywords.

1. Click the Search icon in the GigaVUE-FM header to open the Keyword field and type the port ID 1/1/x5 followed by the keyword *down*.

As shown in [Figure 16: Categories Returned for Port ID and Down](#), the 1/1/x5 and down occur 60 times in the Port category.

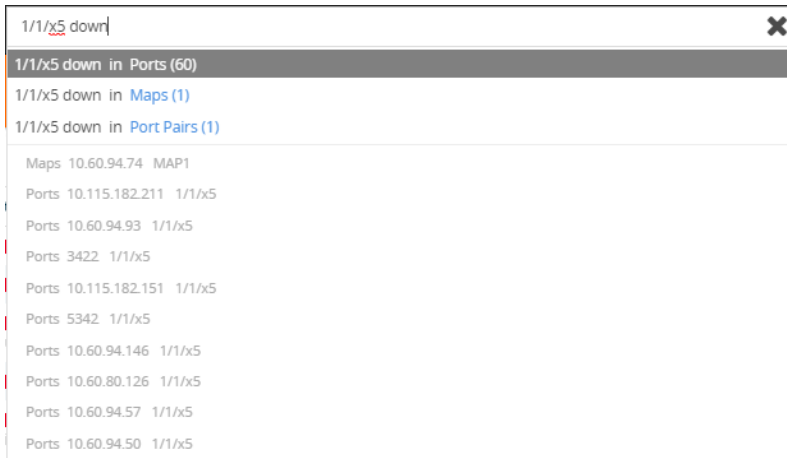


Figure 16: Categories Returned for Port ID and Down

2. Click on the Ports category to view the results.
3. Click on an item search results to see the port information. A Port quick view displays for the selected port as shown in Figure 17: Port Quick View for Search Results.

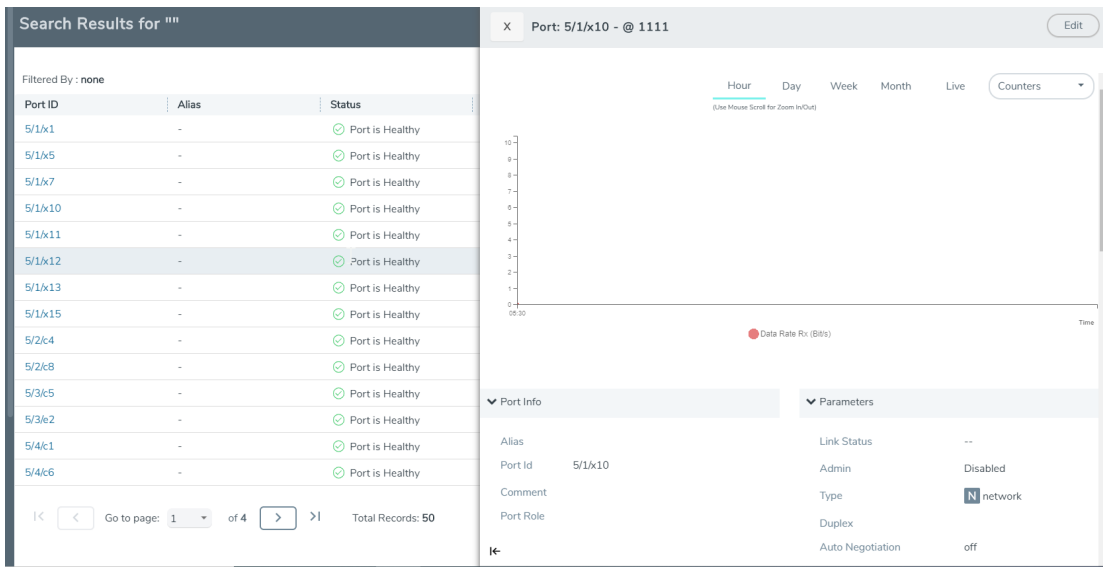


Figure 17: Port Quick View for Search Results

Example 2: Searching for Port Details of Devices Managed by GigaVUE-FM

In this example, you want to retrieve port information from all the devices managed by GigaVUE-FM and that are up. This example also shows the use of a non-alphabetic character as the keyword.

1. Click the Search icon in the GigaVUE-FM header to open the Keyword field and type the backslash character (/) and up.

As shown in Figure 18: Categories Returned for Port Details of All Devices and up, the search returns results in several categories.

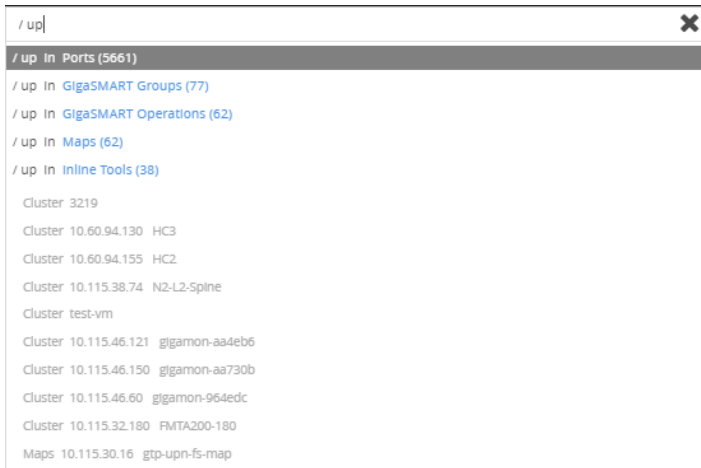


Figure 18: Categories Returned for Port Details of All Devices and up

2. Click on the Ports category to view the results.
3. Click on an item search results to see the port information.

Filtering Search Results

When selecting a search result for a category, GigaVUE-FM opens a page that lists the results for that category.

To change the filter, do the following:

1. Click **Filter**.
The Filter quick view displays.
2. Add or remove filters by selecting items from the Filter quick view.

New GigaVUE-FM GUI in 5.8

The GigaVUE-FM Graphical User Interface for software version 5.8 is enhanced for visual appeal, better navigation, and improved readability. This section provides an overview of these changes.

Refer to the following sections for details:



- [Changes in Login Page](#)
- [Changes in Landing Page](#)
- [Changes in Navigation Paths](#)
- [Changes in Quick Views](#)
- [Changes in Icons](#)

NOTE: There are no functional and logical changes associated with these enhancements.

Changes in Login Page

The following table shows the changes in the log in page:

Table 9: Changes to Login Page

Release 5.7	Release 5.8
	

Changes in Landing Page

The following table highlights the changes to the GigaVUE-FM landing page.

Table 10: Enhancements to dashboard and top navigation bar

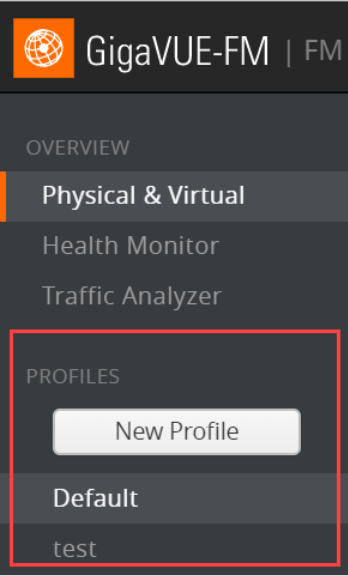
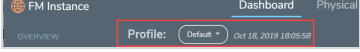
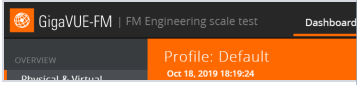
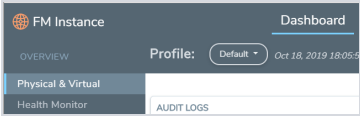
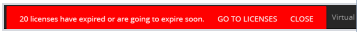
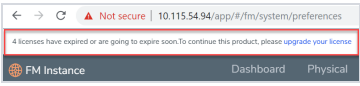
Enhancement	Release 5.7	Release 5.8
<p>Profile:</p> <p>The Profiles option in the Dashboard page allows you to customize the dashboard, as required.</p>	<p>Available in the left navigation pane</p> 	<p>Moved to the top navigation bar.</p> 
<p>Customized GigaVUE-FM Instance Title</p> <p>You can configure an instance name for your GigaVUE-FM instance.</p>	<p>If instance name is configured, both GigaVUE-FM and the name of the instance appears.</p> 	<p>If instance name is configured, then only the name of the GigaVUE-FM instance appears.</p> 
<p>License Expiry Notification</p> <p>When you first open GigaVUE-FM, license expiry notification appears.</p>	<p>Appears as a pop-up message on the top navigation bar hiding the menus.</p> 	<p>Appears as a separate panel just below the browser's address bar.</p> 

Figure 19: Enhancements to Dashboard shows the changes to the GigaVUE-FM 5.8 landing page.

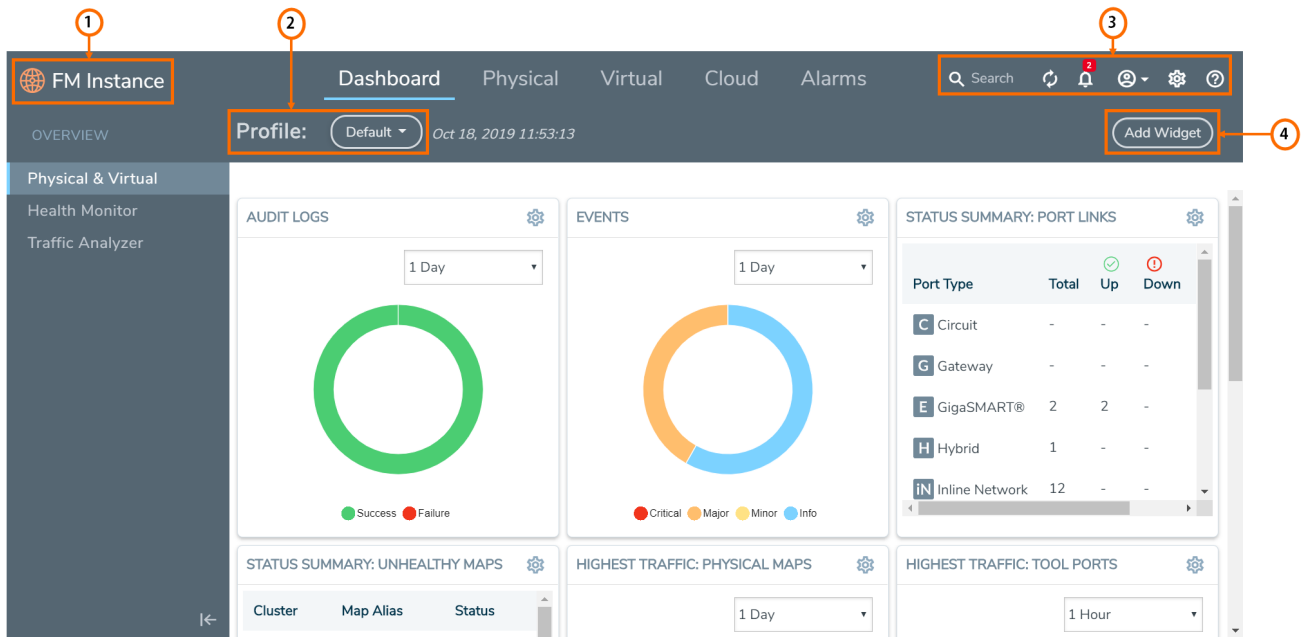


Figure 19: Enhancements to Dashboard

- 1 - GigaVUE-FM Instance Name
- 2 - Profile Option (on the top navigation bar)
- 3 - Outlined Icons
- 4 - Rounded Buttons (for all GUI screens)

Changes in Navigation Paths

Navigation in GigaVUE-FM has been changed to improve usability and customer experience. Refer to the following sections for details:

- [Physical](#)
- [Administration](#)

Notes

- There are no navigation path changes to the Virtual and Cloud pages.
- The pagination bar in the pages is moved to the bottom-left corner of the pages. Refer to [Figure 20: Pagination Bar](#).

Ports															
All Ports															
Ports Discovery															
Fabric Statistics															
Total Ports: 90 Filtered By : none Oct 22, 2019 22:52:20															
<div style="text-align: right;"> Edit Filter Quick Port Editor Export </div>															
<input type="checkbox"/>	Port Id	Alias	Status	Type	Speed	Admin	Link St...	Transe...	SFP Po...	Avg Uti...	Port Fil...	Discov...	Box Ho...	Gigamo...	Rx Only
<input type="checkbox"/>	1/1/g1...		✔ Po...	N	1G	Enabled	up	copper		0 / 0	—	none	dev1	Disabl...	N/A
<input type="checkbox"/>	1/1/g2...	test	✔ Po...	N	1G	Enabled	up	copper		0 / 0	—	none	dev1	Disabl...	N/A
<input type="checkbox"/>	1/1/g3...		✔ Po...	N		Disabl...	--	copper		0 / 0	—	none	dev1	Disabl...	N/A
<input type="checkbox"/>	1/1/g4...		✔ Po...	N		Disabl...	--	copper		0 / 0	—	none	dev1	Disabl...	N/A
<input type="checkbox"/>	1/1/g5...		✔ Po...	N		Disabl...	--	copper		0 / 0	—	none	dev1	Disabl...	N/A
<input type="checkbox"/>	1/1/g6...		✔ Po...	N		Disabl...	--	copper		0 / 0	—	none	dev1	Disabl...	N/A
<input type="checkbox"/>	1/1/g7...		⊘ Po...	N		Disabl...	--	copper		0 / 0	—	none	dev1	Disabl...	N/A
<input type="checkbox"/>	1/1/g8...		✔ Po...	N		Disabl...	--	copper		0 / 0	—	none	dev1	Disabl...	N/A
<input type="checkbox"/>	1/1/g9...		✔ Po...	N		Disabl...	--	copper		0 / 0	—	none	dev1	Disabl...	N/A

⏪ ⏩ Go to page: 1 of 90 ⏪ ⏩

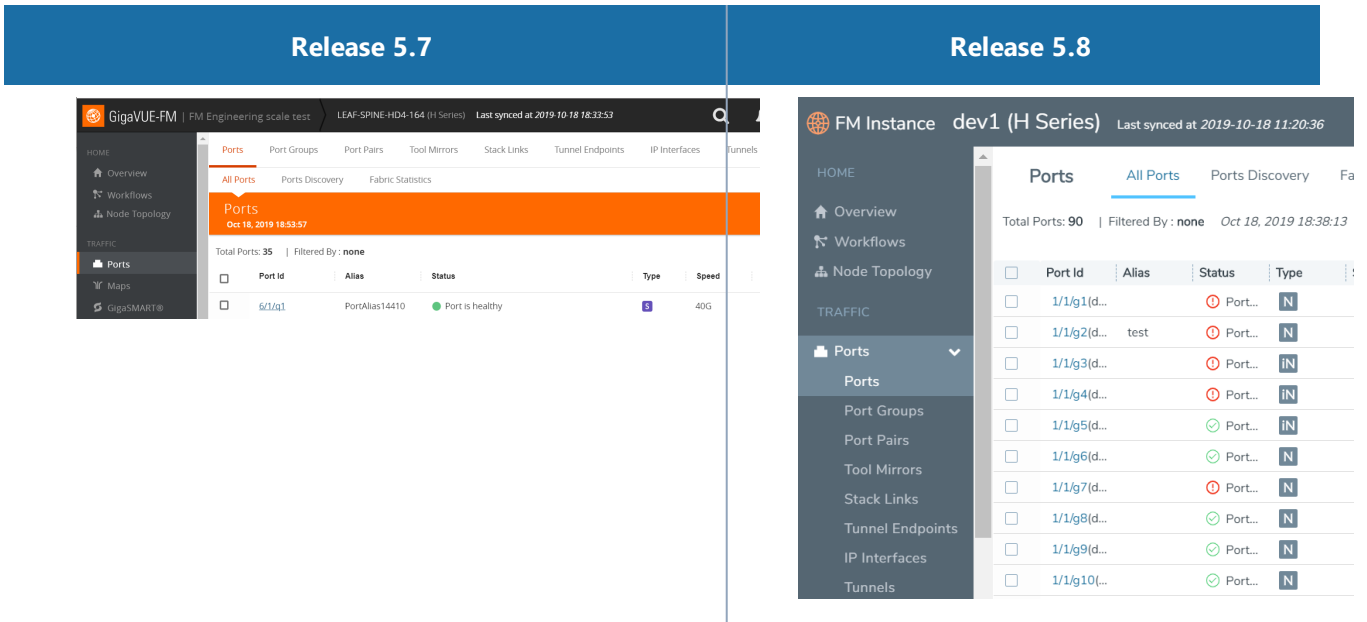
Figure 20: Pagination Bar

Physical

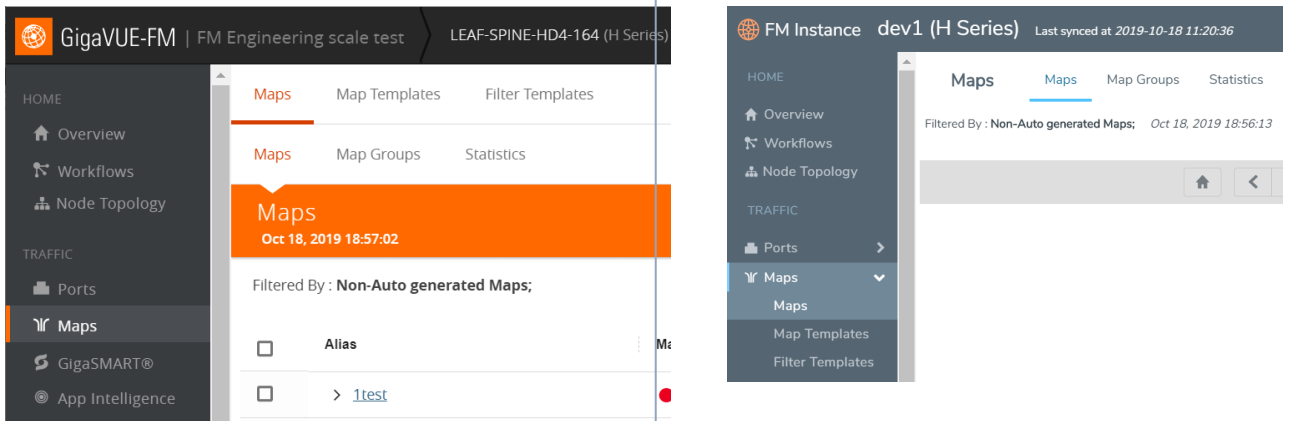
Starting in software version 5.8.00, the following sub-menu options under the **Physical** menu have been moved to the left navigation pane:

- [Traffic > Ports](#)
- [Traffic > Maps](#)
- [Traffic > GigaSMART](#)
- [Traffic > Inline Bypass](#)
- [Traffic > Active Visibility](#)
- [System > Roles and Users](#)
- [System > Settings](#)
- [Support > Debug](#)

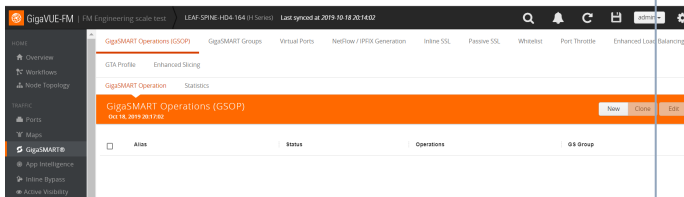
Release 5.7	Release 5.8
Traffic > Ports	



Traffic > Maps

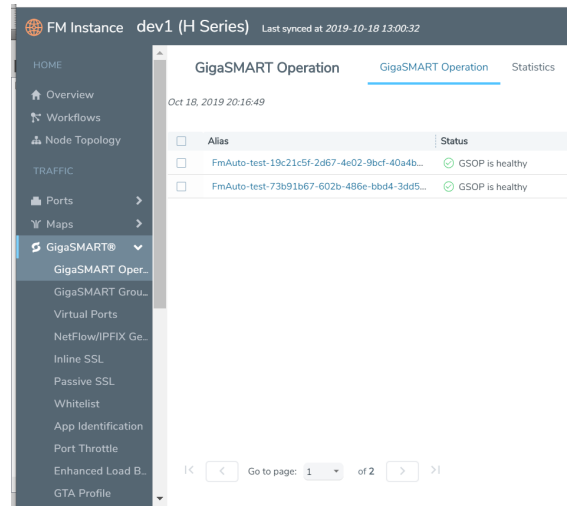


Traffic > GigaSMART

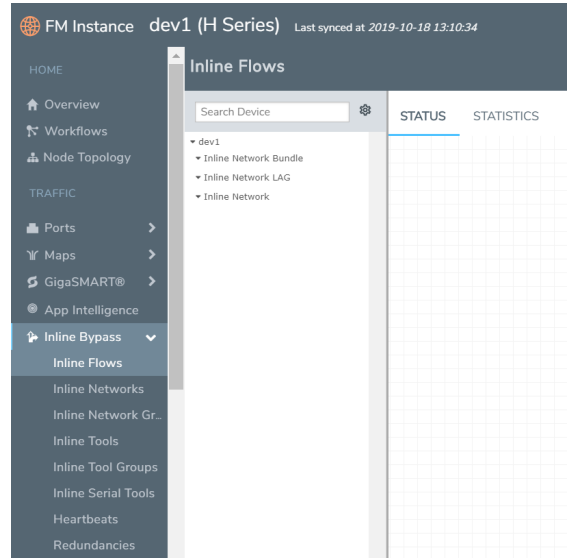
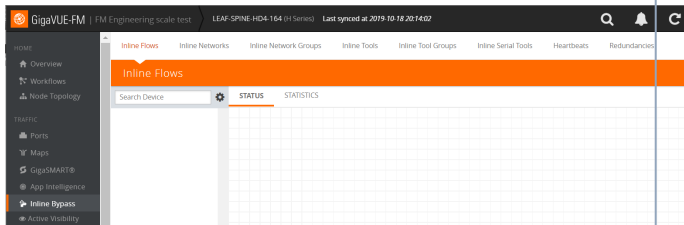


Release 5.7

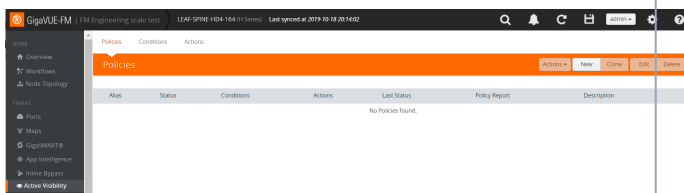
Release 5.8



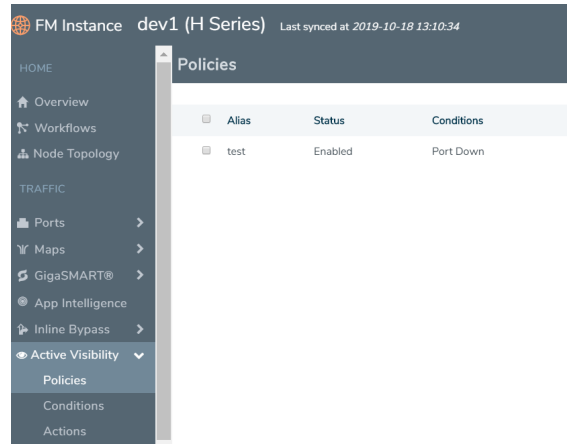
Traffic > Inline Bypass



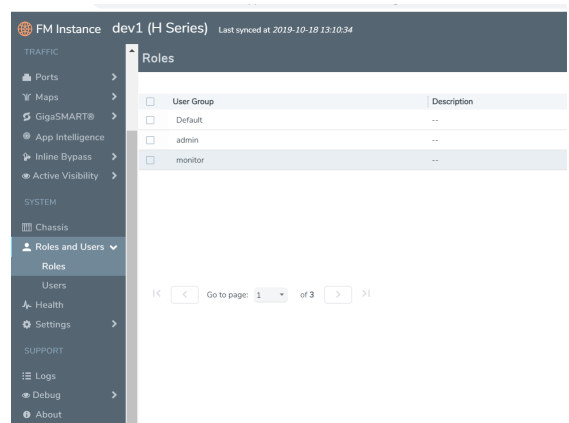
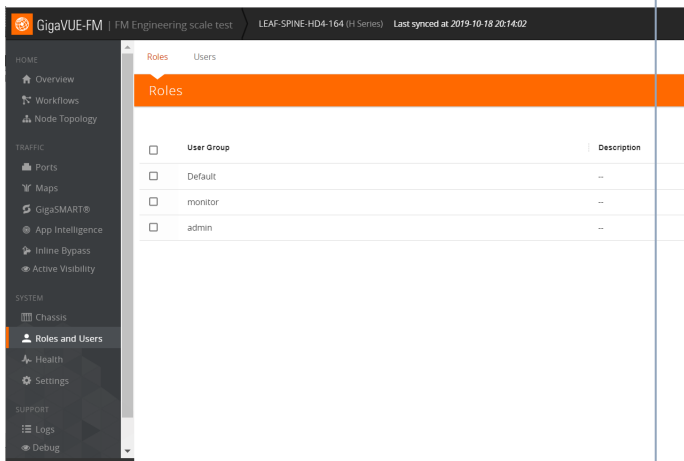
Traffic > Active Visibility



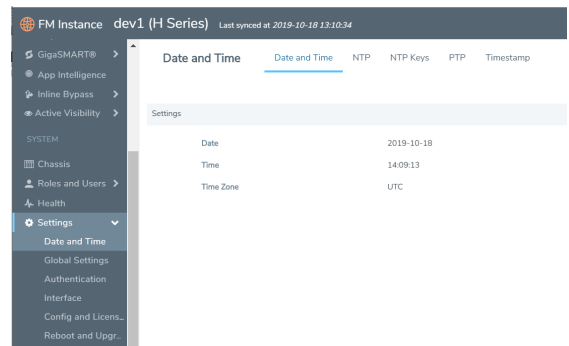
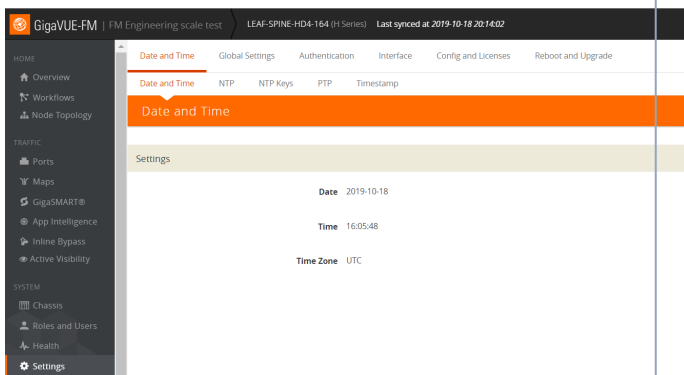
Release 5.7
Release 5.8



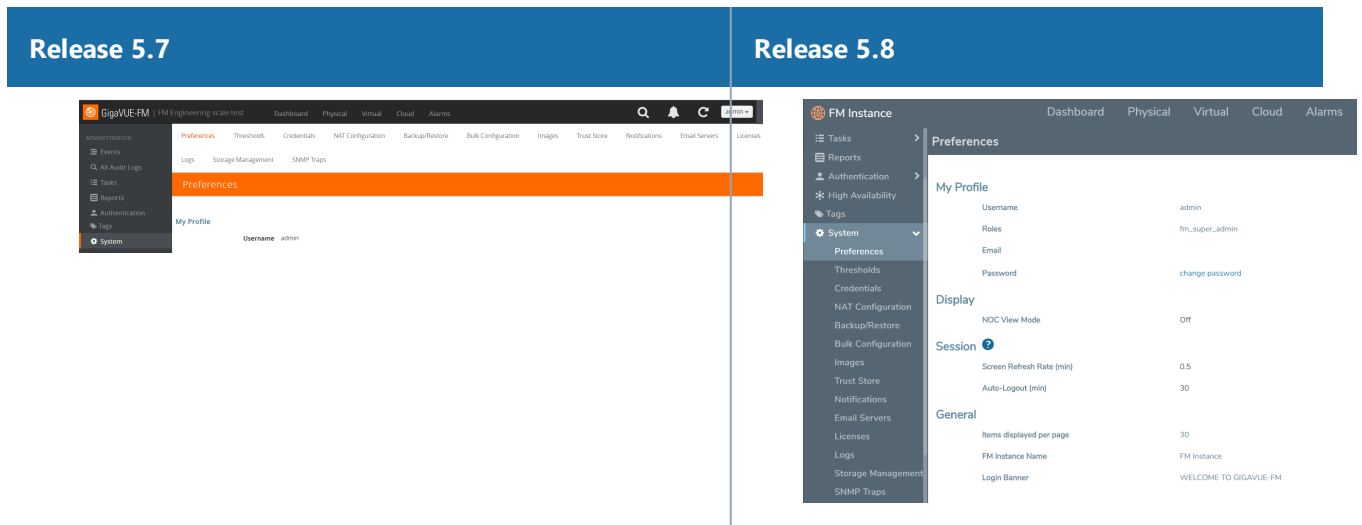
System > Roles and Users



System > Settings



Support > Debug



Changes in Quick Views

A quick view provides easy access to Visibility Fabric details such as nodes, ports, and traffic policies. Click on Port ID, Map Alias, Port error counts and other such items to get detailed information about these items.

Figure 21: Quick View Option in GigaVUE-FM 5.8 shows the changes incorporated in quick view for GigaVUE-FM 5.8 release. If you expand the quick view, the page appears on top of the existing page (without navigating to the page). Click *Edit* to navigate to the port edit page.

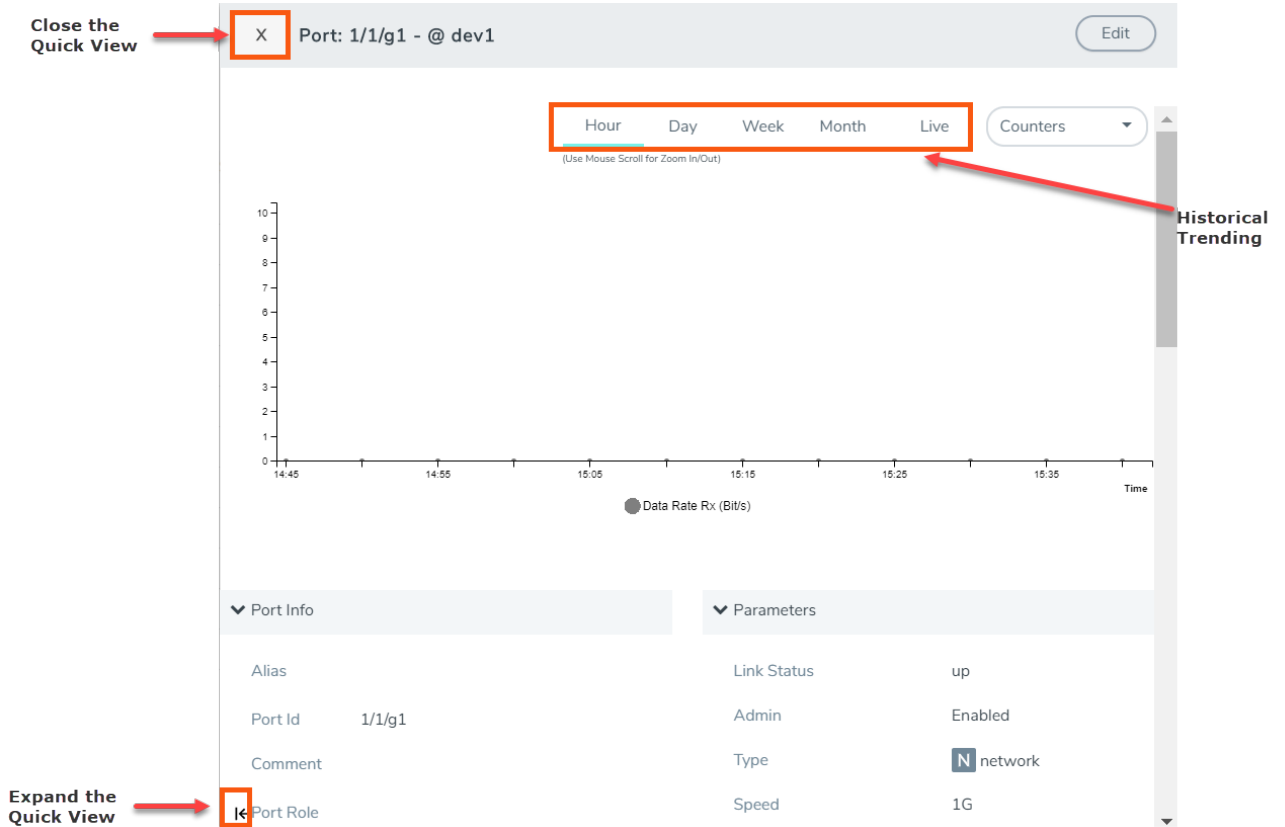


Figure 21: Quick View Option in GigaVUE-FM 5.8

Changes in Icons

The following icon types have been changed:

- Port Type Icons
- Health Status Notification Icons

Port Type Icons






The port type icons have been changed in GigaVUE-FM 5.8 release as follows:




Release 5.7	Release 5.8

Release 5.7					Release 5.8				
Port Type	Total	Up	Down	Disabled	STATUS SUMMARY: PORT LINKS				
C Circuit	77	63	8	6	Port Type	Total	Up	Down	Disabled
G Gateway	3	-	3	-	C Circuit	-	-	-	-
E GigaSMART®	485	393	92	-	G Gateway	-	-	-	-
H Hybrid	214	194	6	14	E GigaSMART®	2	2	-	-
iN Inline Network	671	101	177	393	H Hybrid	-	-	-	-
iT Inline Tool	189	85	87	17	iN Inline Network	8	-	-	8
N Network	16386	1291	1922	13173	iT Inline Tool	-	-	-	-
S Stack	423	156	200	67	N Network	77	16	-	61
T Tool	997	483	433	81	S Stack	1	1	-	-
					T Tool	2	1	-	1

Health Status Notification Icons

The health status notification icons have been changed in GigaVUE-FM 5.8 release as follows:

Health Status	5.7 Release	5.8 Release
Up (connected, healthy)		
Warning		
Down (disconnected), unreachable		

Health Status	5.7 Release	5.8 Release
		
Unknown		

Dashboard

This section describes the Dashboards available in GigaVUE-FM that display information about the physical and virtual nodes managed by GigaVUE-FM as well as information about GigaVUE-FM itself.

The section provides information about the following topics:

- [Physical Dashboard](#)

Describes the dashboards that display physical nodes managed by GigaVUE-FM and GigaVUE-FM itself.

- [Health Monitor Dashboard](#)

Describes the health monitor dashboards that provides health information about GigaVUE-FM.

Physical Dashboard

This chapter describes the dashboards that provide information about the physical nodes, ports, port links, maps, GigaSMART, audit logs, and events on a single page.

This chapter covers the following topics:

- [Overview of the Physical Dashboard](#)
- [Physical Dashboard Profiles](#)
- [Physical Dashboard Quick Views](#)
- [Physical Dashboard Widgets](#)

Overview of the Physical Dashboard

The Physical Dashboard is a central location to monitor all the physical nodes and clusters that are managed by GigaVUE-FM. The widgets in the dashboard provides a quick visual overview of inventory and events, GigaSMART traffic, highest and lowest traffic by maps and ports, traffic comparison by tags, most and least utilized traffic, and health status. Refer to [New GigaVUE-FM GUI in 5.8.](#)

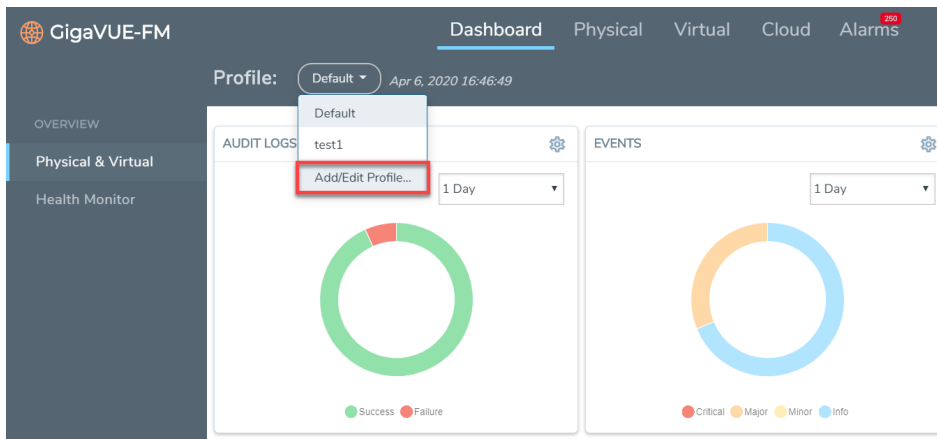
Note:If the percentage displayed in a pie-chart is negligible or less , then it would be difficult to click on the pie-chart arc and view the details .

Physical Dashboard Profiles

The Physical Dashboard displays a number of default widgets when you first log in. They are displayed with the profile labeled as **Default**. You can create multiple profiles and choose the widgets to be displayed in each profile based on the data you want to proactively monitor and troubleshoot in your Visibility Fabric.

To create a new profile:

1. Click **Dashboard** on the top navigation bar.
2. On the Physical & Virtual dashboard page, select the profile drop-down and click **Add/Edit Profile**.



3. In the **Add/Edit Profile...** box, enter the name of the new profile and click **Enter**.
The new profile name is displayed under Profiles. The new profile page is displayed.
4. (Optional) Click the Edit icon and select **Set as Login Profile** if you want the new profile to display as your default Physical Dashboard.

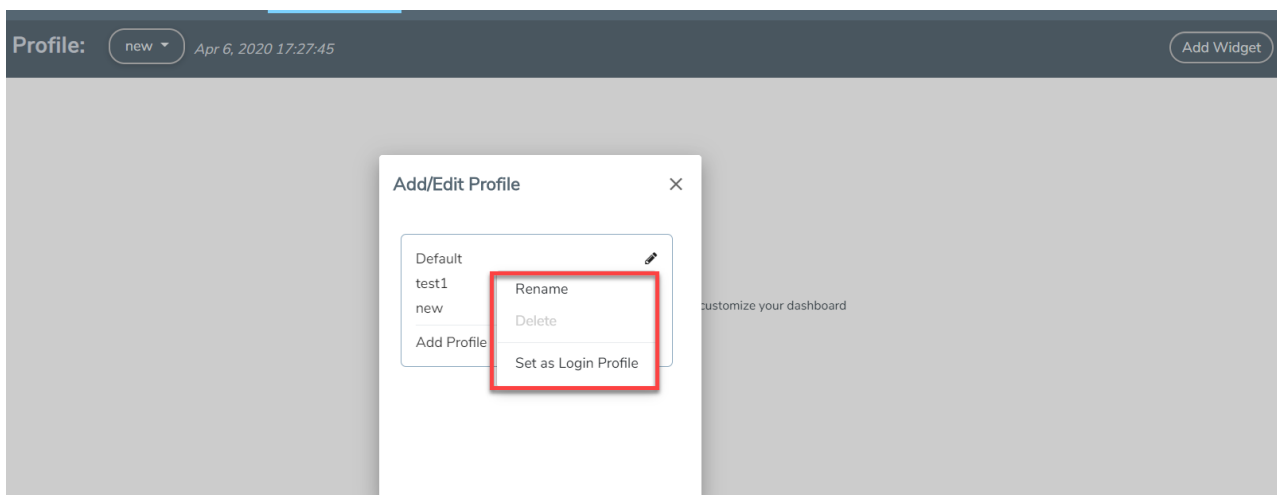


Figure 22: Profile Settings (add the setting icon label)

To change the profile name, click **Rename**, edit the name, and press **Enter**.

To delete the profile, click **Delete**. If you delete a default profile, then the initial default profile is automatically set as the login profile unless you actively select another one. Once deleted, there is no option to recover those dashboards.

NOTE: When GigaVUE-FM is upgraded, the profiles created in the previous version are not retained in the latest version.

Keep in mind the following regarding the widgets on the dashboard.

- Widget and trending data is available based on the GigaVUE-FM license purchased. For the base package, the data is not stored for more than 1 day. The prime package users can select any option including 1 month.
- Individual widgets can be resized and saved as part of the profile. Each widget can expand in both horizontal and vertical planes. The other widgets self-adjust when the widgets are manipulated.
- The widgets can also be dragged and dropped to different section of the page. Refer to [Figure 23: Resized and Repositioned Widgets](#).
- The data points can be viewed when the mouse is hovered over the graph as shown in [Figure 23: Resized and Repositioned Widgets](#).
- The widgets such as Unhealthy Maps opens a quick view when clicked on the cluster info or the map alias. The quick view shows more details relating to that specific map.
- The trending information can also be changed for each widget on the same dashboard.
- The port and map health status changes on the device reflect instantly on the screen.
- The color-coded legends are available at the bottom of each widget.

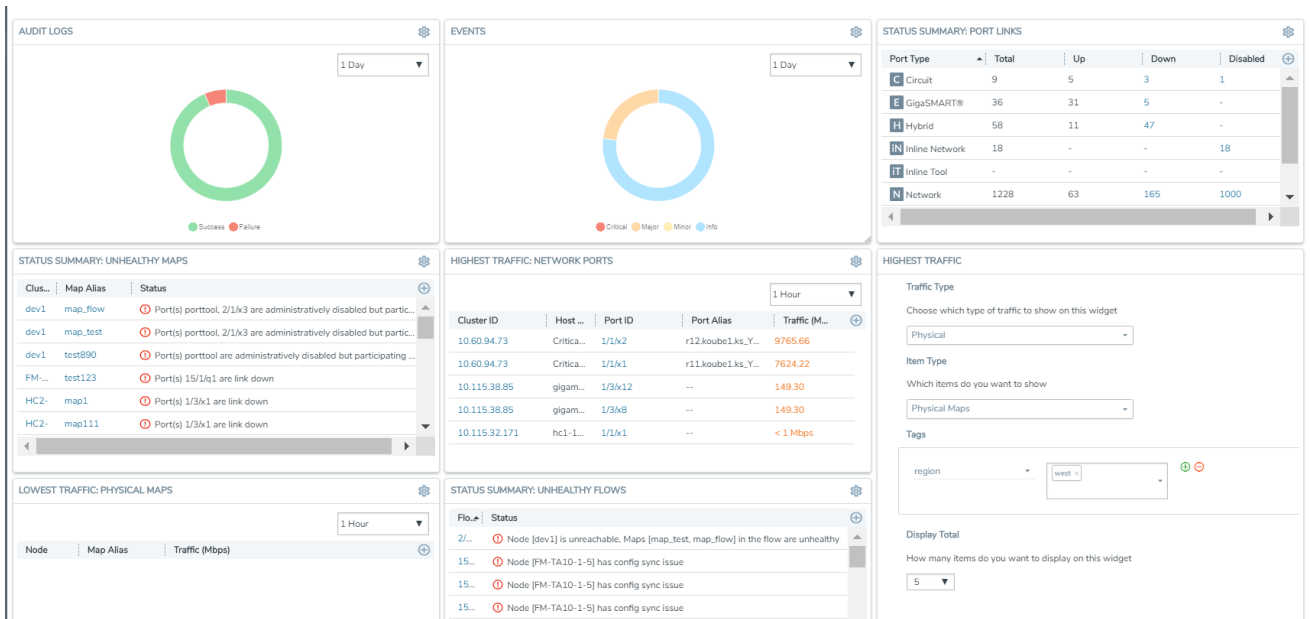


Figure 23: Resized and Repositioned Widgets

Physical Dashboard Quick Views

When reviewing the widgets available on the Physical & Virtual dashboard, clicking on the options in the widgets takes you to the details page relating to the information for that node. For example, on the Nodes by Model or Software Version widget, you click on the node and it takes you to the Physical Nodes page.

For more information about Physical Nodes, refer to [Manage GigaVUE® Nodes and Clusters](#).

Physical Dashboard Widgets

This section describes the widgets that can be created and viewed on the Physical Dashboard.

- [Highest Traffic](#)
- [Lowest Traffic](#)
- [Traffic Comparison By Tags](#)
- [Most Utilized Traffic](#)
- [Least Utilized Traffic](#)
- [Inventory](#)
- [Status Summary](#)

The default profile displays the following widgets:

- Highest Traffic: Network Ports, Tool Ports, and Physical Maps
- Status Summary: Unhealthy Maps and Port Links
- Audit Logs
- Events

You can customize the widgets by modifying the physical dashboard profiles. Refer to [Physical Dashboard Profiles](#) for more information.

Highest Traffic

The Highest Traffic widget can be created for the following:

- Physical
 - Physical maps
 - Fabric maps
 - Network ports
 - Tool ports
 - Stack ports
 - Hybrid ports
 - Inline network ports
 - Inline tool ports
- GigaSMART
 - GigaSMART groups
 - GigaSMART operations

You can create as many Highest Traffic widgets as you want listing up to 5, 10, 15, 20, 50, or 100 items in each widget.

The highest traffic is measured in megabytes per second (Mbps). You can specify the period over which the amount of traffic must be calculated. The period can be 1 hour, 1 day, 1 week, or 1 month.

Cluster ID	Host ...	Port ID	Port Alias	Traffic (Mbps)
10.60.94.73	Critica...	1/1/x2	r12.koube1.ks_YR0742_DS	9764.35
10.60.94.73	Critica...	1/1/x1	r11.koube1.ks_YR0741_DS	7623.20
10.115.38.85	gigam...	1/3/x12	--	149.58
10.115.38.85	gigam...	1/3/x8	--	149.58
10.115.32.171	hc1-1...	1/1/x1	--	< 1 Mbps

Figure 24: Highest Traffic: Example

The physical maps are listed by the node ID, map alias, and the traffic in Mbps.

The ports are listed by the node on which they are used and the port alias. You can create the Highest Traffic widget for the following ports:

- Network ports
- Tool ports
- Stack ports
- Hybrid ports
- Inline network ports
- Inline tool ports

The highest traffic for GigaSMART operations or GigaSMART group can be displayed as shown in [Figure 25: Highest Traffic GigaSMART](#).

Node	GS Group	Traffic (Mbps)
dev6	GS_1	
HC2-	gs_1	
gigamon-...	gsg1	

Figure 25: Highest Traffic GigaSMART

To configure the Highest Traffic widget:

1. Click **Dashboard** on the top navigation bar.
2. On the Physical & Virtual dashboard page, select the profile in which you want to add the widget.
3. Click **Add New Widget**. The Add New Widget window is displayed. Refer to [Figure 26: Add New Widget](#).

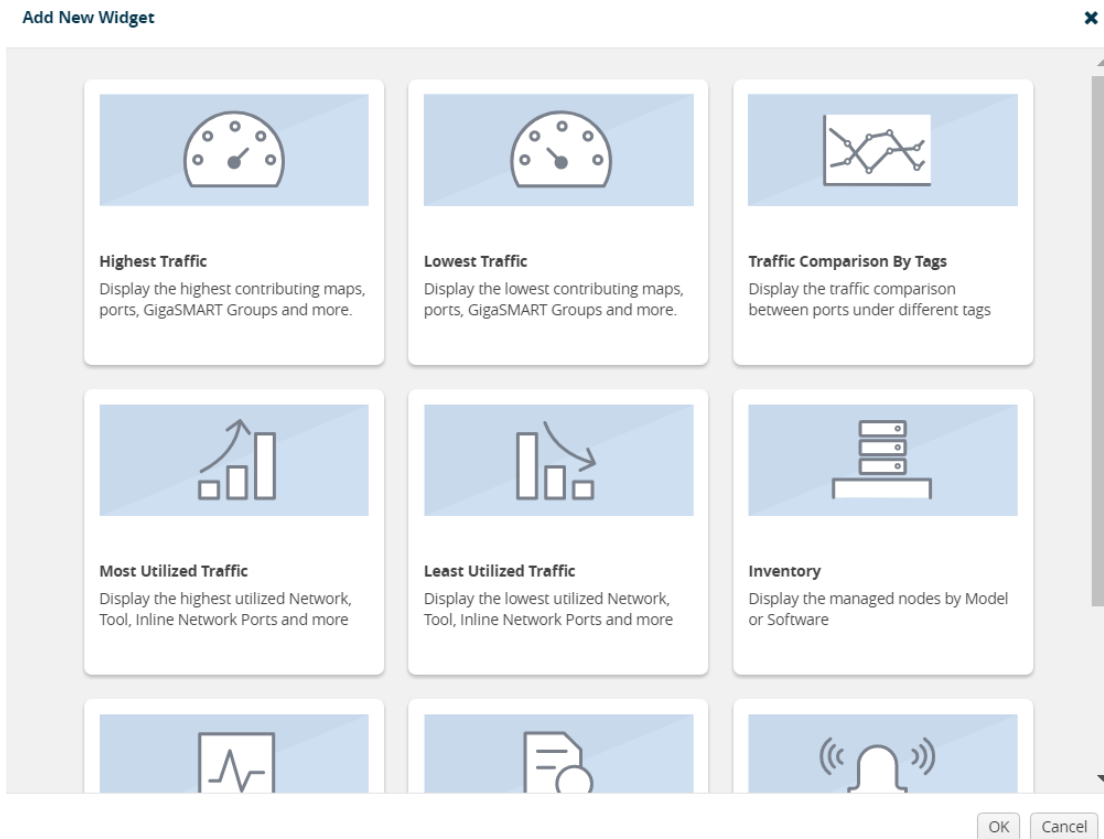
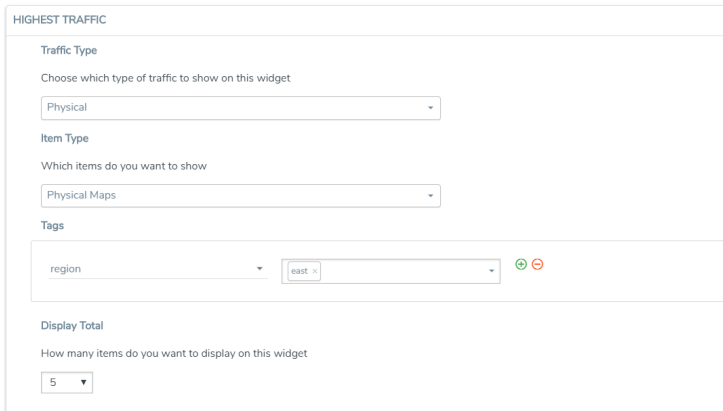


Figure 26: Add New Widget

4. In the Add New Widget window, select **Highest Traffic** and click **OK**. The Highest Traffic configuration window is displayed. Refer to [Figure 27: Highest Traffic Configuration](#).



HIGHEST TRAFFIC

Traffic Type
Choose which type of traffic to show on this widget
Physical

Item Type
Which items do you want to show
Physical Maps

Tags
region east

Display Total
How many items do you want to display on this widget
5

Figure 27: Highest Traffic Configuration

5. From the **Traffic Type** drop-down list, select one of the following traffic types:
 - Physical—Allows you to view the physical maps and ports that contribute to the highest traffic distribution.
 - GigaSMART—Allows you to view the virtual ports, GigaSMART groups, and GigaSMART operations that contribute to the highest traffic distribution.
6. From the **Item Type** drop-down list, select the item you want to view. The options displayed are based on the traffic type you selected in step 5.
7. Select the required tag id and tag values .
8. From the **Display Total** drop-down list, select the number of items to be displayed. By default, the number of items selected for display is 5.
9. Click **OK**.

Lowest Traffic

The Lowest Traffic widget lists the physical maps, flow maps, ports, and GigaSMART that contribute to the lowest traffic within a specified time. You can create as many Lowest Traffic widgets as you want listing up to 5, 10, 15, 20, 50, or 100 items in each widget.

The traffic flowing through a port or a map rule is measured in megabytes per second (Mbps). You can specify the period over which the amount of traffic is calculated. The period can be 1 hour, 1 day, 1 week, or 1 month.

LOWEST TRAFFIC: NETWORK PORTS				
1 Day				
Cluster ID	Host N...	Port ID	P...	Tr.⊕
10.115.32.171	hc1-1...	1/1/x1	--	< 1 Mbps
10.115.38.85	gigam...	1/3/x12	--	146.77
10.115.38.85	gigam...	1/3/x8	--	146.77
10.60.94.73	Critica...	1/1/x1	r...	7487.46
10.60.94.73	Critica...	1/1/x2	r...	9590.48

Figure 28: Lowest Traffic

The Lowest Traffic widget is configured exactly the same way as the Highest Traffic widget. To configure the Lowest Traffic widget, refer to the configuration steps provided in [Highest Traffic](#) . In **step 4**, select **Lowest Traffic** and click **OK**. The Lowest Traffic configuration window is displayed.

Traffic Comparison By Tags

The Traffic Comparison By Tags widget allows you to compare the aggregated traffic flowing through the list of ports associated to tags. You can choose to view up to four traffic comparisons in a single widget. You can create as many Traffic Comparison By Tags widgets as necessary in the selected profile and provide a customized name for each widget. The customized name helps you to differentiate multiple traffic comparison widgets in a single profile.

In this example, there is traffic flowing from GigaVUE-TA10 to GigaVUE-HC2. You can group the tool ports in GigaVUE-TA10 and create a tag as TA_TOOL. Then, you can group the network ports in GigaVUE-HC2 and create a tag as HC2_NETWORK. Refer to [Figure 29: Example for Traffic Comparison By Tags Widget](#).

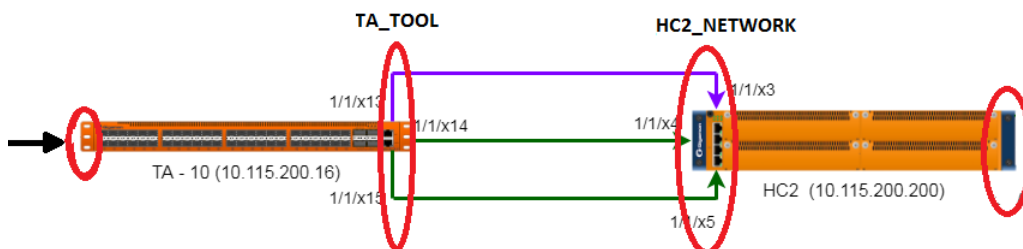


Figure 29: Example for Traffic Comparison By Tags Widget

Using the Traffic Comparison By Tags widget, you can compare the egress traffic passing through the ports associated with T A_TOOL with the ingress traffic passing through the ports associated with HC2-NETWORK, and quickly analyze if there is any packet loss associated. Refer to [Figure 30: Traffic Comparison By Tags](#)

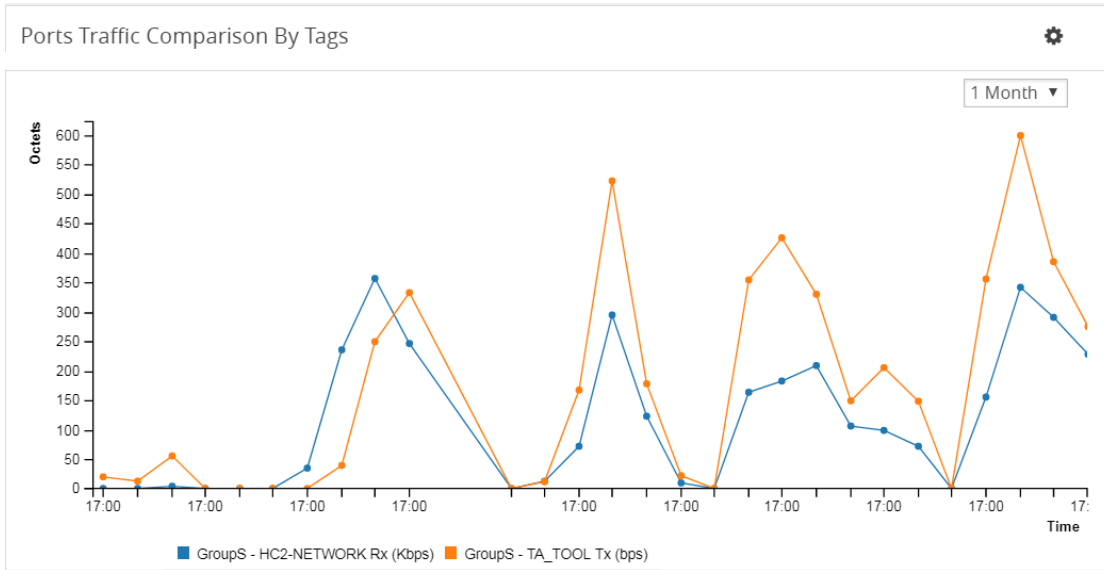


Figure 30: Traffic Comparison By Tags

The Traffic Comparison By Tags widget also allows you to choose just the egress traffic passing through the ports associated with T A_TOOL and view the graph.

The following statistics can be viewed for physical ports and GigaSMART:

Traffic Type	Statistics
Physical Ports	<ul style="list-style-type: none"> Data Rate Packet Rate Packet Errors Packet Discards Packet Drops Port Utilization
GigaSMART	<ul style="list-style-type: none"> Data Rate Packet Rate Packet Drops Packet Errors Packet Buffer Packet Terminated

The aggregated traffic comparison is displayed as a graph. You can choose to display the data over a day, an hour, a week, or a month. However, when you select a week or a month, the time period is not persisted. The data is defaulted to 1 day when you navigate away from the Physical Dashboards page and then return to the page. Click the notification icon at the top of the window and view the alarms and notifications displayed (refer to [Figure 31: Notifications](#)):

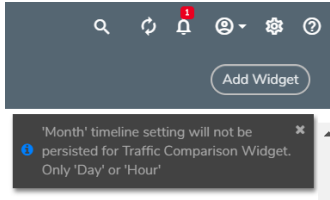


Figure 31: Notifications

Hovering the mouse over the lines in the graph displays the tag name, traffic direction, and traffic flow (Mbps).

To configure the Traffic Comparison By Tags widget:

1. Click **Dashboard** on the top navigation bar.
2. On the Physical & Virtual dashboard page, select the profile in which you want to add the widget.
3. Click **Add New Widget**. The Add New Widget window is displayed. Refer to [Figure 26: Add New Widget](#).

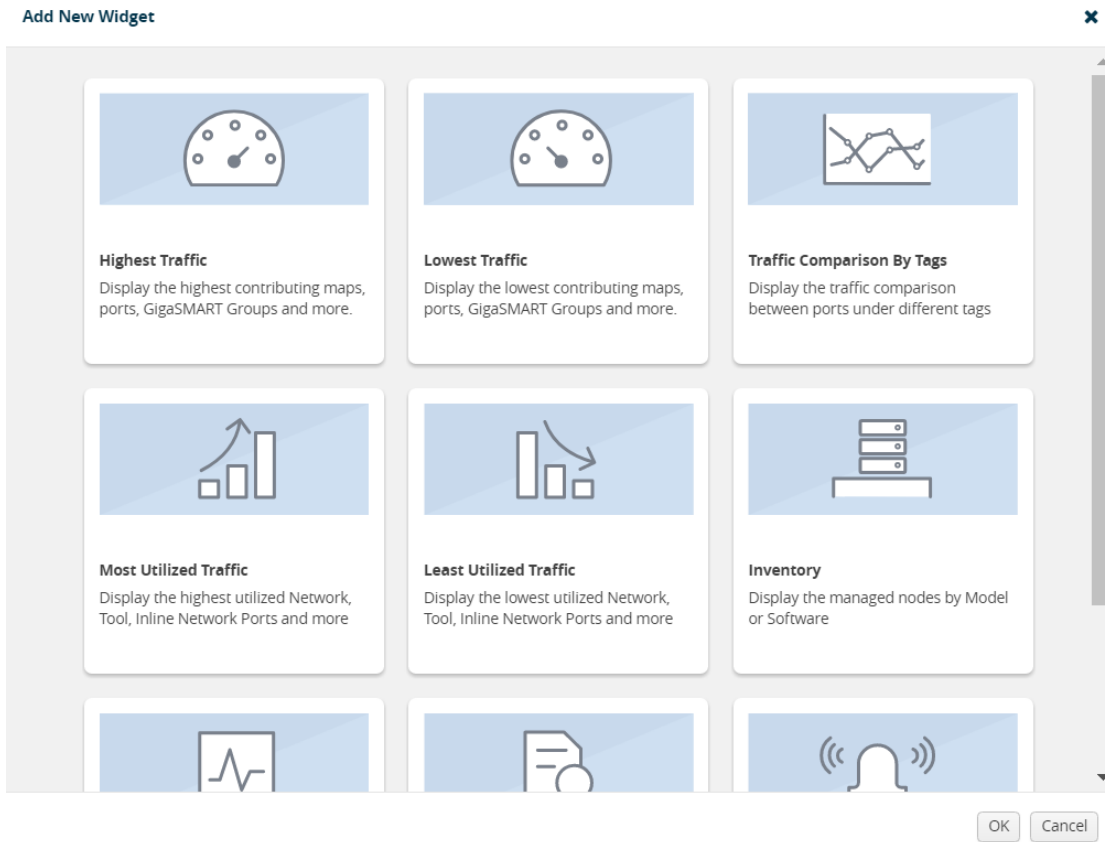


Figure 32: Add New Widget

4. In the Add New Widget window, select **Traffic Comparison By Tags** widget and click **OK**. The Traffic Comparison by Tags configuration window is displayed. Refer to [Figure 33: Traffic Comparison By Tags Configuration](#).

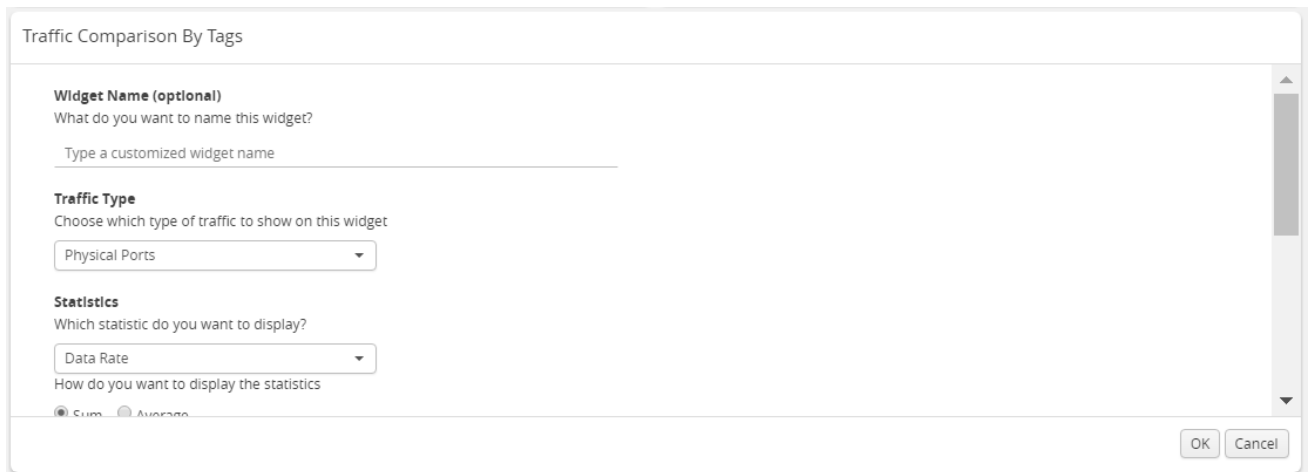


Figure 33: Traffic Comparison By Tags Configuration

5. (Optional) In the **Widget Name** box, enter a customized name for the widget. Customized name helps to differentiate multiple traffic comparison widgets in the same profile.

6. From the **Traffic Type** drop-down list, select one of the following traffic types:
 - Physical Ports
 - GigaSMART
7. From the **Statistics** drop-down list, select the type of statistic to view in the comparison graph.
8. Select **Sum** or **Average** to determine the way to display the statistics.
9. In Tag Items, select two or more tags to compare.
 - a. For Traffic 1, select the tag name and tag value from the drop-down lists.
 - b. Select **Ingress (Rx)** or **Egress (Tx)** to determine the traffic direction.
 - c. Repeat step a and step b to select the next traffic for comparison.
10. Click **OK**.

Most Utilized Traffic

The Most Utilized Traffic widget allows you to view the ports with highest percentage utilization. These ports can belong to a specific site or all sites. The highest percentage utilization is displayed over the selected period. The period can be 1 hour, 1 day, 1 week, or 1 month to view the utilization percentage.

The Most Utilized Traffic widget lists the ports with the Cluster ID, Port Id, port alias, and the utilization percentage.

Node	Port ID	Port Alias	Utilization (%)
10.115.200.16	1/1/x5	networkporterrorstesting	51%
10.115.200.16	1/1/x1	1Gigtool	10%
10.115.200.16	1/1/x2	test-alias-ta-series	10%

Figure 34: Most Utilized Traffic Widget

To configure the Most Utilized Traffic widget:

1. Click **Dashboard** on the top navigation bar.
2. On the Physical & Virtual dashboard page, select the profile in which you want to add the widget.
3. Click **Add New Widget**. The Add New Widget window is displayed. Refer to [Figure 35: Add New Widget](#).

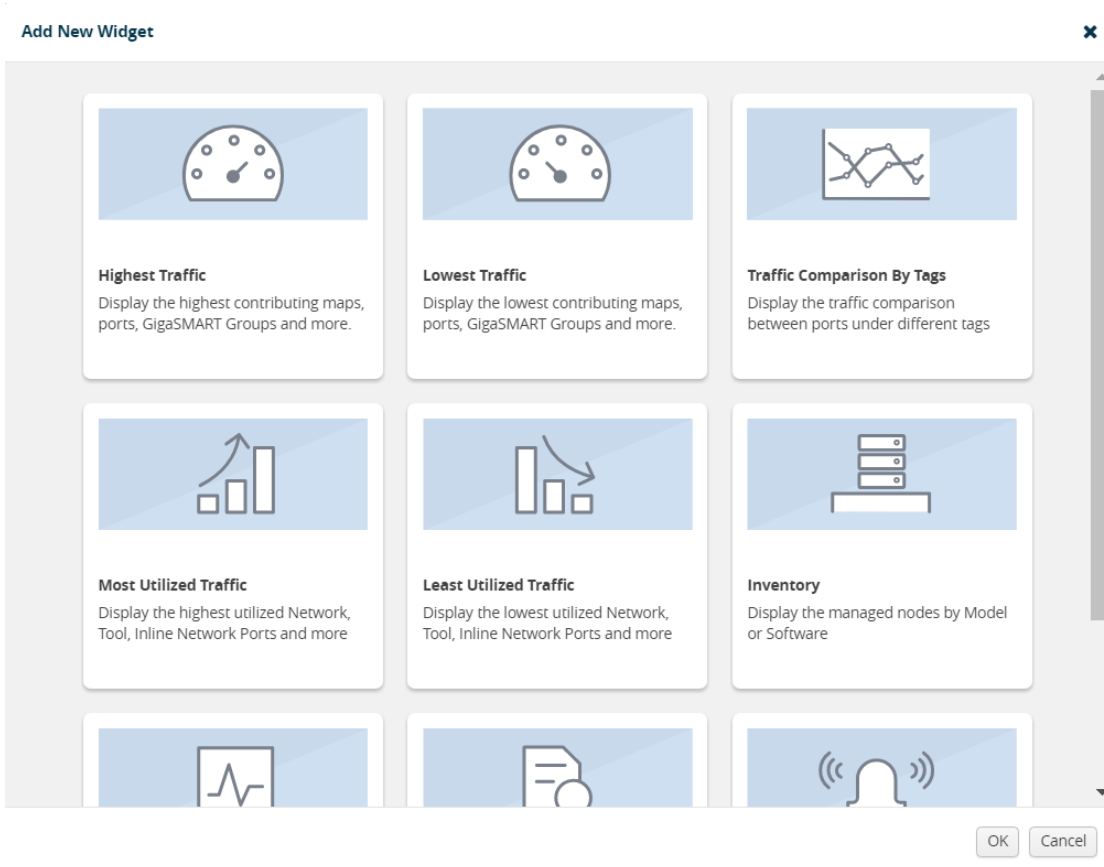


Figure 35: Add New Widget

4. In the Add New Widget window, select **Most Utilized Traffic** and click **OK**. The Most Utilized Traffic configuration window is displayed. Refer to [Figure 36: Most Utilized Traffic Configuration](#).

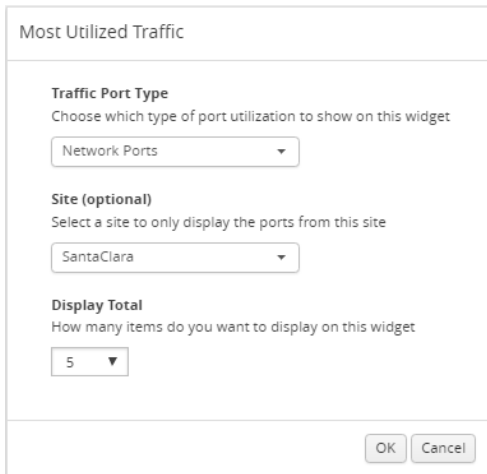


Figure 36: Most Utilized Traffic Configuration

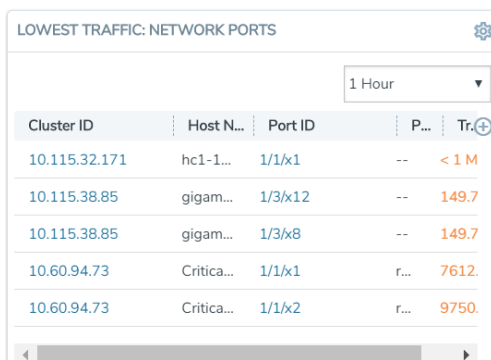
5. From the **Traffic Port Type** drop-down list, select one of the following port types:
 - Network Ports

- Tool Ports
 - Stack Ports
 - Hybrid Ports
 - Inline Network Ports
 - Inline Tool Ports
6. (Optional) From the **Site** drop-down list, select a site to display the utilization percentage of the ports associated to the site.
 7. From the **Display Total** drop-down list, select the number of items to be displayed. By default, the number of items selected for display is 5.
 8. Click **OK**.

Least Utilized Traffic

The Least Utilized Traffic widget allows you to view the lowest percentage utilization for all the ports associated with the selected site or all sites. The lowest percentage utilization is displayed over the selected period, You can choose 1 hour, 1 day, 1 week, or 1 month to view the utilization percentage.

The Least Utilized Traffic widget lists the ports with the Cluster ID, Host name, Port number, port alias, and the utilization percentage. The utilization percentage is displayed as either a table or a bar graph. By default, a table is displayed. You can click the arrow to change the display to a graph as shown in [Figure 37: Least Utilized Traffic](#).



The screenshot shows a widget titled "LOWEST TRAFFIC: NETWORK PORTS" with a settings icon in the top right. Below the title is a dropdown menu set to "1 Hour". The main content is a table with the following columns: Cluster ID, Host N..., Port ID, P..., and Tr. (with a plus sign in a circle). The table contains five rows of data:

Cluster ID	Host N...	Port ID	P...	Tr. (+)
10.115.32.171	hc1-1...	1/1/x1	--	< 1 M
10.115.38.85	gigam...	1/3/x12	--	149.7
10.115.38.85	gigam...	1/3/x8	--	149.7
10.60.94.73	Critica...	1/1/x1	r...	7612.
10.60.94.73	Critica...	1/1/x2	r...	9750.

Figure 37: Least Utilized Traffic

The Least Utilized Traffic widget is configured exactly the same way as the Most Utilized Traffic widget. To configure the Least Utilized Traffic widget, refer to the configuration steps provided in [Most Utilized Traffic](#). In **step 4**, select **Least Utilized Traffic** and click **OK**.

Inventory

The Inventory widget provides information about the physical nodes by model and software.

Nodes by Model

The Nodes by Model widget displays the number of nodes managed by the current instance of GigaVUE-FM as a bar graph. Each bar in the graph indicates the number of each device model managed. Hovering the mouse over a bar in the graph displays the model name and the total number. [Figure 38: Nodes by Model](#) shows a Node by Model widget displaying six different nodes managed by GigaVUE-FM. Hover the mouse over the bar to view the number of devices in each node.

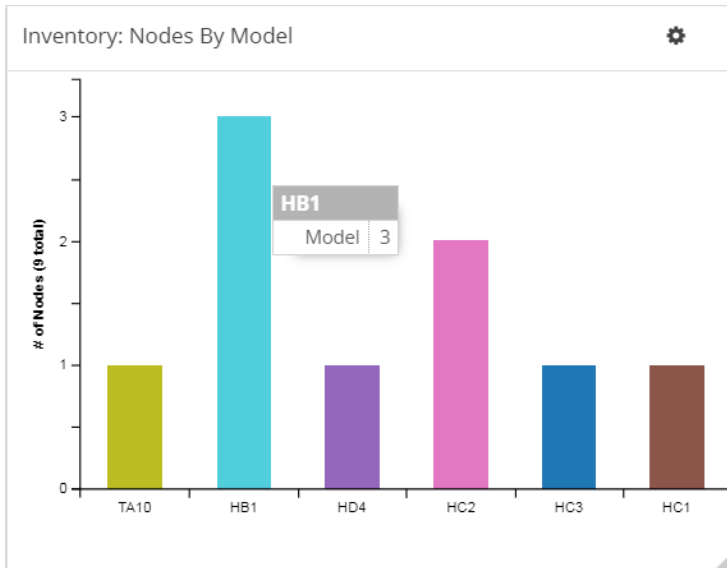


Figure 38: Nodes by Model

Nodes by Software Version

The Nodes by Software Version widget presents a graph that helps you to quickly view the software versions of the nodes that GigaVUE-FM is managing and the total percentage of each version. Each software version is assigned a color in the graph, which is specified by the legend. Hovering the mouse over an area in the graph displays the total number of software version used as a percentage. In [Figure 39: Nodes by Software Version](#), the Nodes by Software Version widget shows that there are 7 instances of version 5.1 and 2 instances of version 5.0, which is 22 percent of the total versions installed.

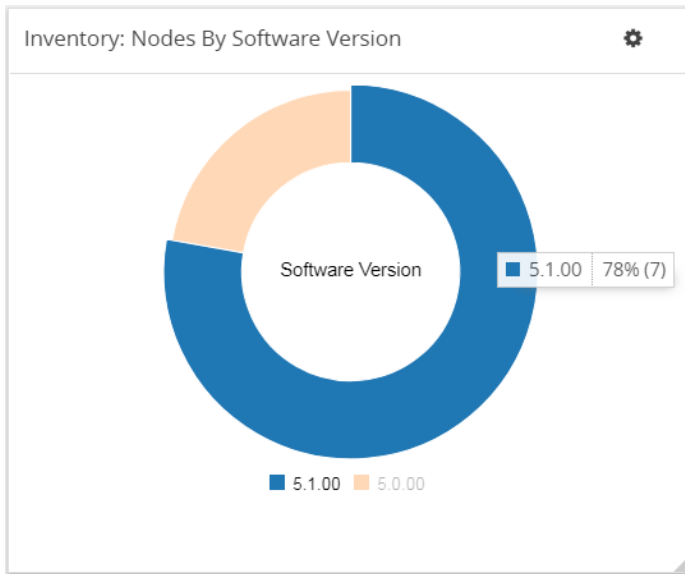


Figure 39: Nodes by Software Version

To configure the Inventory widget:

1. Click **Dashboard** on the top navigation bar.
2. On the Physical & Virtual dashboard page, select the profile in which you want to add the widget.
3. Click **Add New Widget**. The Add New Widget window is displayed. Refer to [Figure 40: Add New Widget](#).

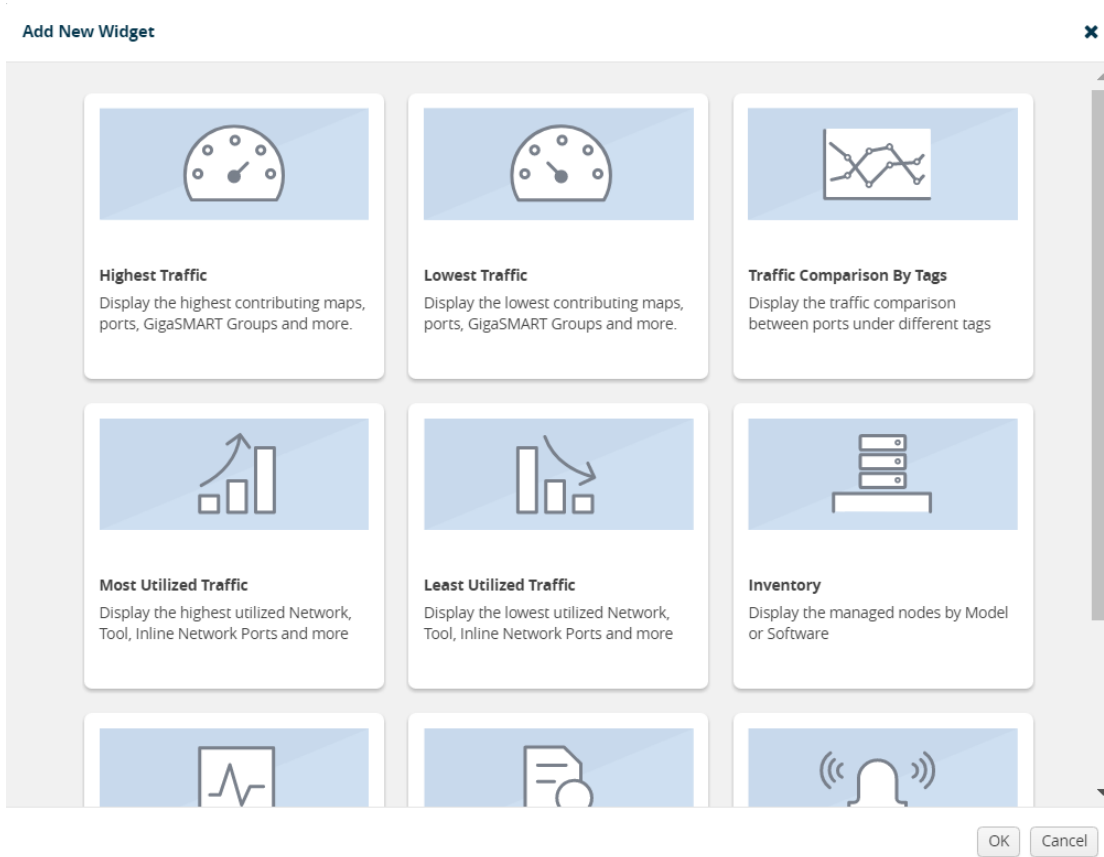


Figure 40: Add New Widget

- In the Add New Widget window, select **Inventory** and click **OK**. The Inventory configuration window is displayed. Refer to [Figure 36: Most Utilized Traffic Configuration](#).

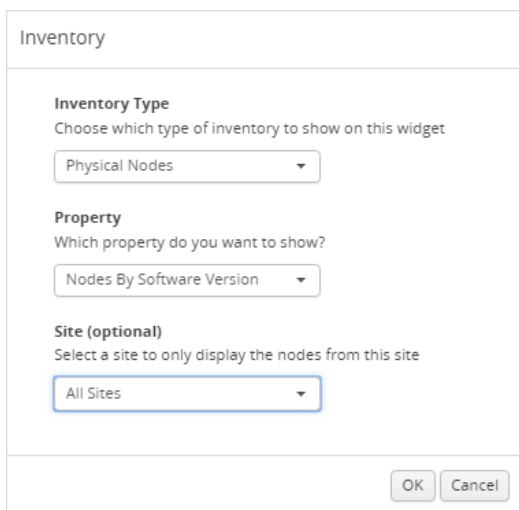


Figure 41: Inventory Configuration

- From the **Inventory Type** drop-down list, select the Physical Nodes.
- From the **Property** drop-down list, select one of the following:

- Nodes by Model
 - Nodes by Software Version
7. (Optional) From the **Site** drop-down list, select a site to display the nodes associated to the site.
 8. Click **OK**.

Status Summary

Refer to the following section for the Status Summary widget details:

- [Nodes' Status Summary](#)
- [Port Link Status Summary](#)
- [Unhealthy Maps](#)
- [Unhealthy Flows](#)
- [Port Drops and Errors](#)
- [Unhealthy Fabric Maps](#)

Nodes' Status Summary

The nodes' status summary widget presents a graph that allows you to quickly view the current status of the physical nodes that GigaVUE-FM is managing and the number of nodes in a particular status, which is indicated by a color in the graph. The possible statuses are:

- Normal (green)
- Warning (yellow)
- Error (orange)
- Critical (red)

For information about how the device status is computed, refer to [Node Health Status](#).

Hovering the mouse over an area in the graph displays the percentage of nodes in that status. In [Figure 42: Nodes' Status Widget](#), the widget shows that there are 5 nodes in Normal status, 4 nodes in Warning status, and 5 nodes in Critical status. There are no nodes in Error status.

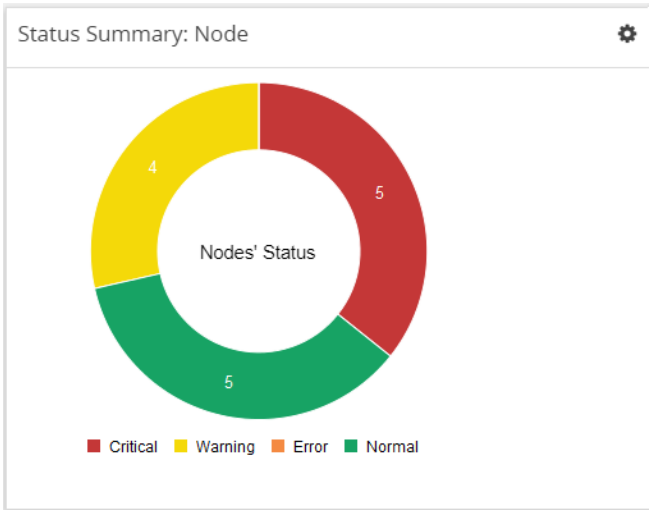


Figure 42: Nodes' Status Widget

Port Link Status Summary

The Port Link status summary widget allows you to view the current link status of all the ports available in the physical nodes currently managed by GigaVUE-FM. Optionally, the Port Link status can be displayed for a specified site. When a particular site is selected in the configuration window, the port link status of all the ports available in the nodes associated to the site are displayed in the Port Link Status Summary dashboard.

Refer to [Figure 43: Status Summary: Port Links Widget](#) for Status Summary: Port Links dashboard for all sites.

The figure shows a table titled "STATUS SUMMARY: PORT LINKS" with a settings icon in the top right corner. The table has five columns: "Port Type", "Total", "Up", "D...", and "Disa...". There is a scroll bar on the right side of the table.

Port Type	Total	Up	D...	Disa...
G Gate...	-	-	-	-
iT Inlin...	-	-	-	-
H Hyb...		2	-	5
C Circuit	10	6	2	2
S Stack	15	4	11	-
iN Inlin...	16	-	-	16
E Giga...	29	28	1	-

Figure 43: Status Summary: Port Links Widget

The Status Summary: Port Links widget lists the following:

- Ports type

- Total number of ports in each type
- Total number of ports in the up, down, or disabled state

Click the numbers in the down or disabled column. A quick view provides detailed information with the cluster ID, device host name, port ID, and port alias of all the ports in the down or disabled state. If the port status is down, the quick view also provides information about the time since when the port has been in down state. The down time is displayed in minutes, hours, days, or months.

Click the port ID link for a detailed view of the packet errors, packet drops, data rate transmitted or received, packet transmitted or received, and so on occurring on an hourly, daily, weekly, or monthly basis. You can also view the related maps, transceiver type, speed, and other detailed information about the port.

NOTE: Prior to software GigaVUE-OS version 4.7, GigaVUE TA Series Traffic Aggregator nodes did not support tool ports. Starting in version 4.7, all gateway ports on GigaVUE TA Series nodes are tool ports. If GigaVUE-FM 3.5 or later is managing nodes running a software version earlier than 4.7, the Ports by Link Status widget may display the number of Gateway nodes.

Unhealthy Maps

The Unhealthy Maps status summary widget lists the maps that are in unhealthy state. The health of a map is determined by the health status of its associated components such as ports, port groups, port pairs, GigaStream, tool port, GigaSMART group, tunneled port, virtual port, inline network, inline tool, inline tool group, inline serial tool group, inline network group, and GigaSMART operations. If the status of any one of the component is down, the corresponding map is also considered unhealthy.

The Unhealthy Maps widget shows the cluster ID, map alias, and current status of the unhealthy map. The possible statuses are:

- Critical (red)
- Warning (amber)
- Unknown (gray)

The health status of a map is shown as gray when the traffic health is still being computed. The status will be updated eventually.

Click on the ID to go directly to the node. Click on the map alias to display the quick view for the map. Hovering the mouse over the status bubble for the map displays the port or ports related to the map that is in an unhealthy state.

Unhealthy Flows

The Unhealthy Flows status summary widget lists the flows that are in unhealthy state. The health of a flow is determined by the health status of the pass-all maps and the priority maps involved in the flow.

A priority map group consists of one or more maps configured with the same source ports. The health of a priority map group is determined by the aggregated health of the constituted maps. The health of the maps is determined by its associated components such as ports, port groups, port pairs, GigaStream, and so on. If any one of the maps in the priority map group is unhealthy, the corresponding priority map group is also considered unhealthy. But, the overall health status of a flow is determined by the aggregated health of the maps that are involved in the flow.

The Unhealthy Flows widget shows the names of the flows that are in unhealthy state and the names of the maps that are unhealthy in the flow. Click the Flow Name to open the flow view page.

For more information about Flows, refer to [Flows](#).

Port Drops and Errors

The Port Drops and Errors status summary widget helps in identifying the ports with packet drops or packet errors in the network. When a particular site is selected in the configuration window, the status summary widget lists the port types associated to the site and the number of ports having packet drops, transmitting errors, or receiving errors in the site. You can view the number of ports with packet drops or packet errors occurring on a daily or an hourly basis.

NOTE: To view the unhealthy ports for GigaSMART, the GigaVUE-OS node must have Software version 5.0.

To view detailed information about the port drops and errors, click the number in the Pkt Drops, Rx Errors, or Tx Errors column. A quick view displays the cluster ID, host name, port ID, port alias, and the number of packet drops or errors for the list of unhealthy ports in the port type. If there are too many ports, click the Filter icon and filter the ports based on the cluster ID, host name, port ID, or port alias. To clear the filters, click **Clear Filters** in the filter dialog box.

In the Unhealthy Ports quick view, click the port ID for a detailed view of the type of packet errors or packet drops occurring on a daily or an hourly basis. You can also view the related maps, transceiver type, speed, and other detailed information about the port, which helps to investigate the reason for the packet drops or packet errors. To return to the Ports quick view, click **Back**.

To configure the Inventory widget:

1. Click **Dashboard** on the top navigation bar.

2. On the Physical & Virtual dashboard page, select the profile in which you want to add the widget.
3. Click **Add New Widget**. The Add New Widget window is displayed. Refer to [Figure 26: Add New Widget](#).

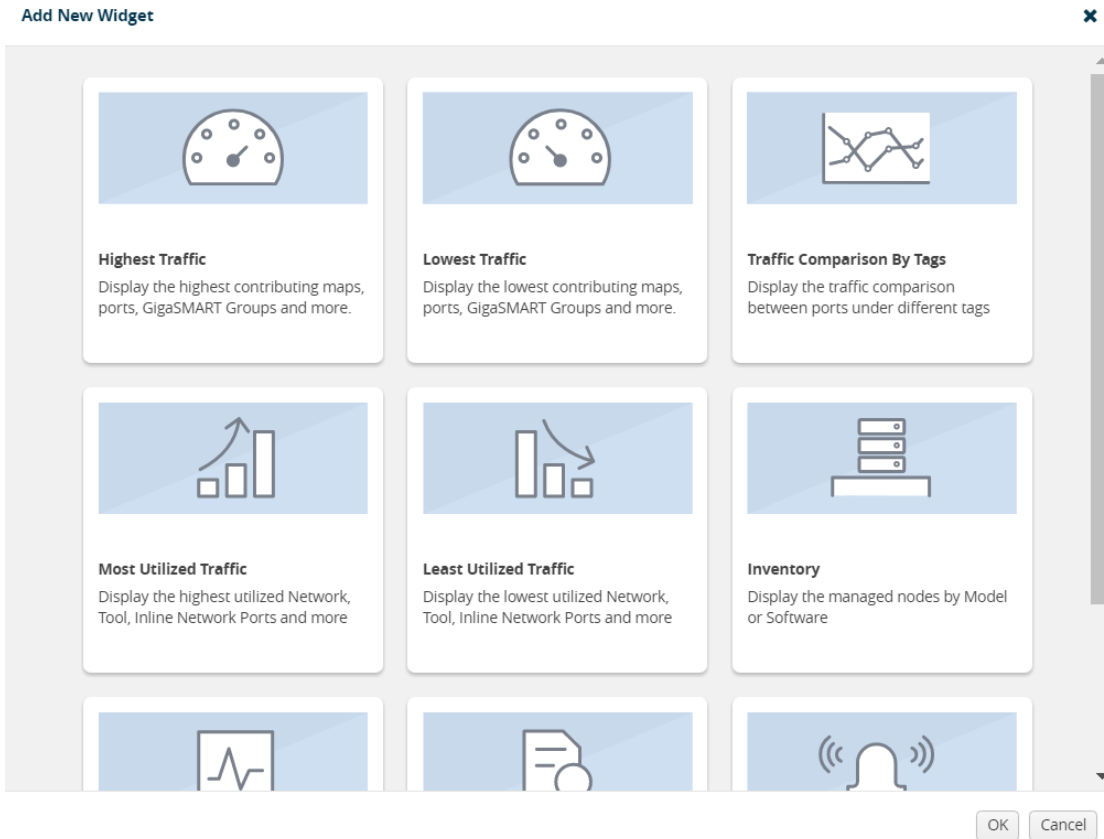


Figure 44: Add New Widget

4. In the Add New Widget window, select **Status Summary** and click **OK**. The Status Summary configuration window is displayed. Refer to [Figure 36: Most Utilized Traffic Configuration](#).

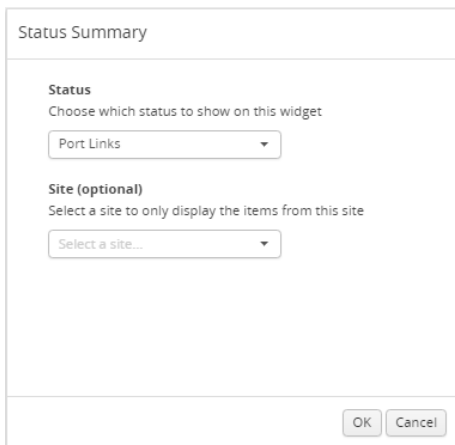


Figure 45: Status Summary Configuration

5. From the **Status** drop-down list, select one of the following:
 - Node—For information, refer to [Nodes' Status Summary](#).
 - Port Links—For information, refer to [Port Link Status Summary](#).
 - Unhealthy Maps—For information, refer to [Unhealthy Maps](#).
 - Port Drops & Errors—For information, refer to [Port Drops and Errors](#).
6. (Optional) From the **Site** drop-down list, select a particular site.
7. Click **OK**.

Unhealthy Fabric Maps

The unhealthy flow maps widget displays the list of unhealthy flow maps.

The Unhealthy Fabric Maps status summary widget lists the maps that are in unhealthy state. The health of a fabric map is determined by the health status of its associated components such as maps, ports, port groups, port pairs, GigaStream, tool port, GigaSMART group, virtual port and GigaSMART operations. If the status of any one of the component is down, the corresponding fabric map is also considered unhealthy.

The Unhealthy Maps widget shows the fabric map alias and the current status of the unhealthy fabric map. The possible statuses are:

- Critical (red)
- Warning (amber)
- Unknown (gray): The health status of a map is shown as gray when the traffic health is still being computed. The status will be updated eventually.

Audit Logs

The Audit Logs widget shows the audit logs of successful and failed events. Optionally, the audit logs can be displayed for a specified site. When a particular site is selected in the configuration window, the audit logs pertaining to the clusters and nodes associated to the site are displayed in the Audit Logs dashboard.

The Audit Logs widget presents a graph that allows you to quickly view the number of logs in successful or failure state. In the graph, the state is indicated by color. The possible log results are:

- Success (green)
- Failure (red)

Hovering the mouse over an area in the graph displays the percentage of audit logs in that result. You can also specify the audit log statuses that have occurred over the past hour, day, week, or month. [Figure 46: Audit Logs by Result](#) shows the audit log results over each of the time periods.

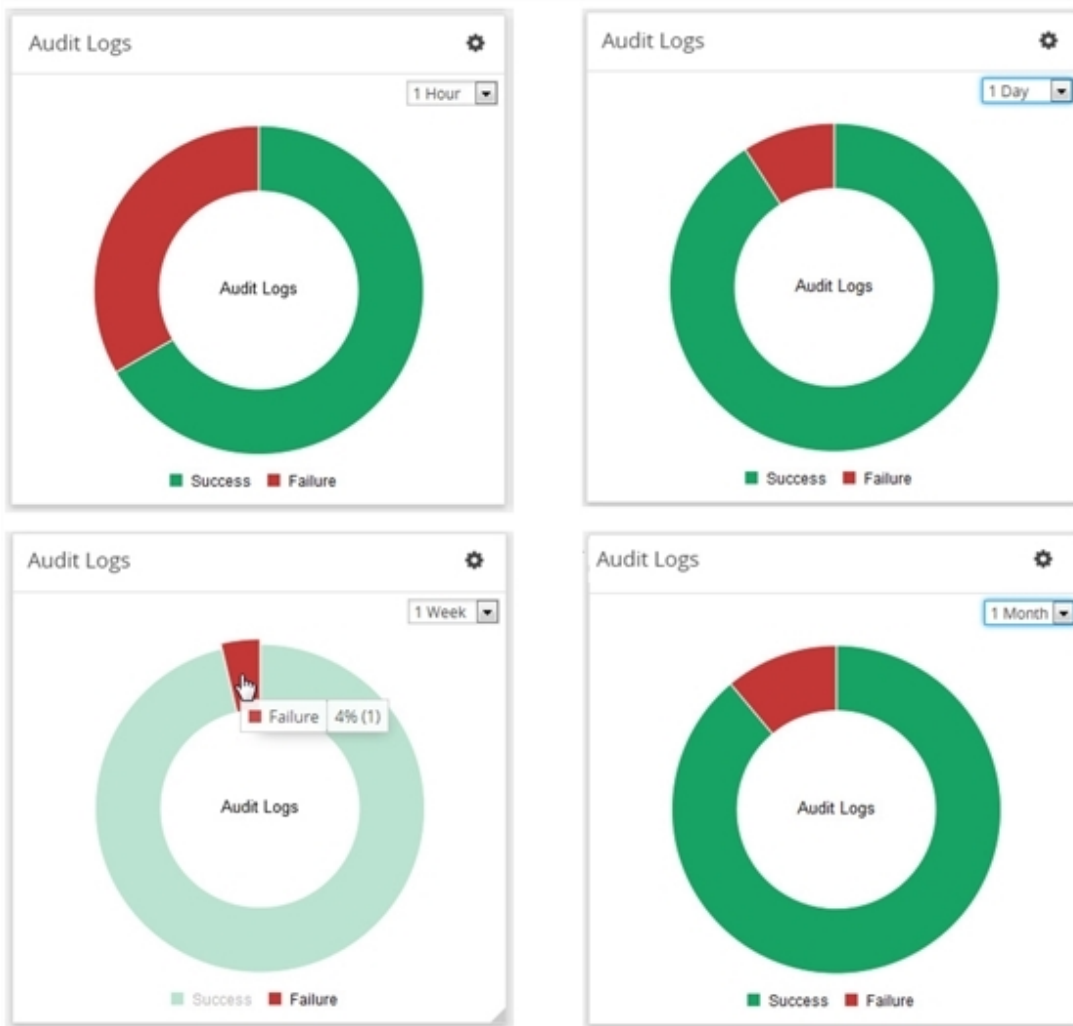


Figure 46: Audit Logs by Result

In this example, the Audit Logs widget shows that there is a log with the failure status that has occurred in the last hour. When you go to the audit logs page, you can see the entries, which matches with the information displayed in Audit Logs widget: two successes and one failure due to an incorrect log in.

To configure the Audit Logs widget:

8. Click **Dashboard** on the top navigation bar.
9. On the Physical & Virtual dashboard page, select the profile in which you want to add the widget.
10. Click **Add New Widget**. The Add New Widget window is displayed. Refer to [Figure 26: Add New Widget](#).

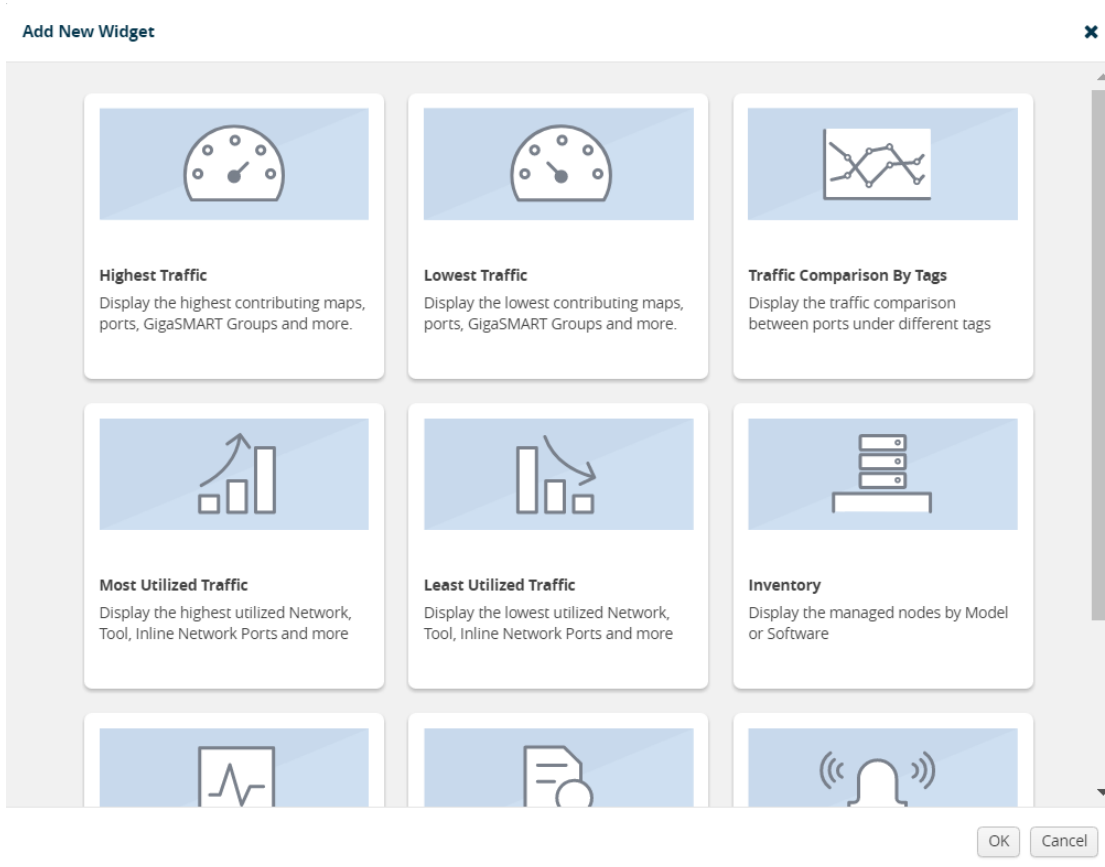


Figure 47: Add New Widget

11. In the Add New Widget window, select **Audit Logs** and click **OK**. The Audit Logs configuration window is displayed. Refer to [Figure 36: Most Utilized Traffic Configuration](#).

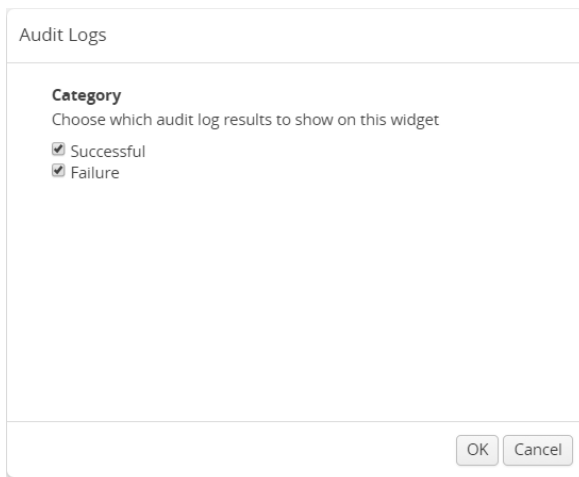


Figure 48: Status Summary Configuration

12. Choose the category of audit log results you want to view:

- Successful
- Failure

13. Click **OK**.

Events

The Events widget presents a graph that shows the number of events that have occurred within a particular severity level, which is indicated by a color in the graph. Optionally, the events can be displayed for a specified site. When a particular site is selected in the configuration window, only the events pertaining to the clusters and standalone nodes associated to the site are displayed in the Events dashboard.

The possible severity levels are:

- Information (blue)
- Major (orange)
- Minor (yellow)
- Critical (red)

Hovering the mouse over an area in the graph displays the percentage and the number of events that have occurred within the selected severity level. You can also select the time period to view the number of events that have occurred over the past hour, day, week, or month.

Figure 49: Events Widget shows the number of events that have occurred in the past week in each severity level for all sites. If you want more detail about the events, select **Events** in the Physical page.

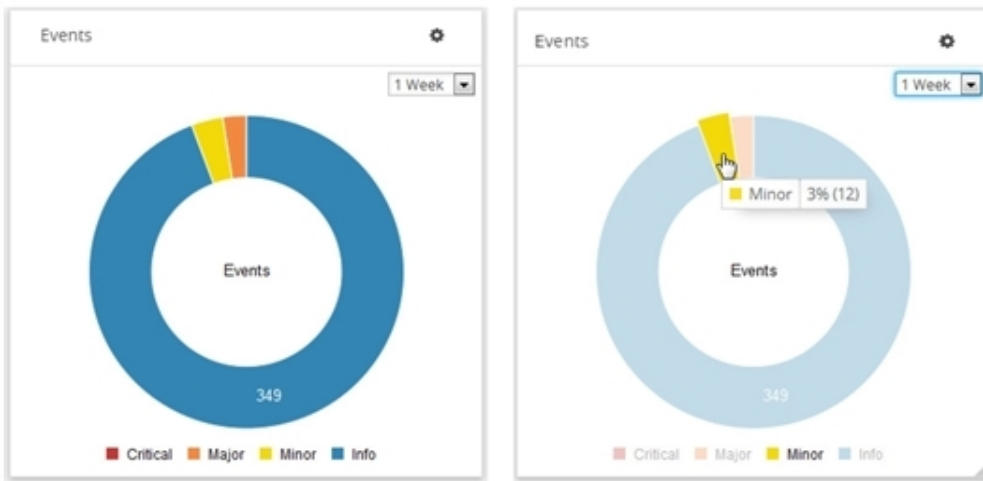


Figure 49: Events Widget

Figure 49: Events Widget shows the number of events that have occurred in the past week in each severity level for Santa Clara site.

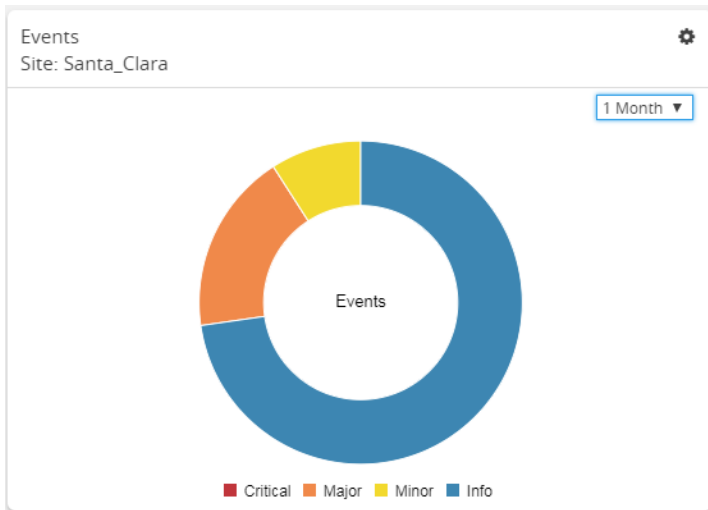


Figure 50: Events Widget for Santa Clara

To configure the Events widget:

- 1 Click **Dashboard** on the top navigation bar.
14. On the Physical & Virtual dashboard page, select the profile in which you want to add the widget.
15. Click **Add New Widget**. The Add New Widget window is displayed. Refer to [Figure 26: Add New Widget](#).

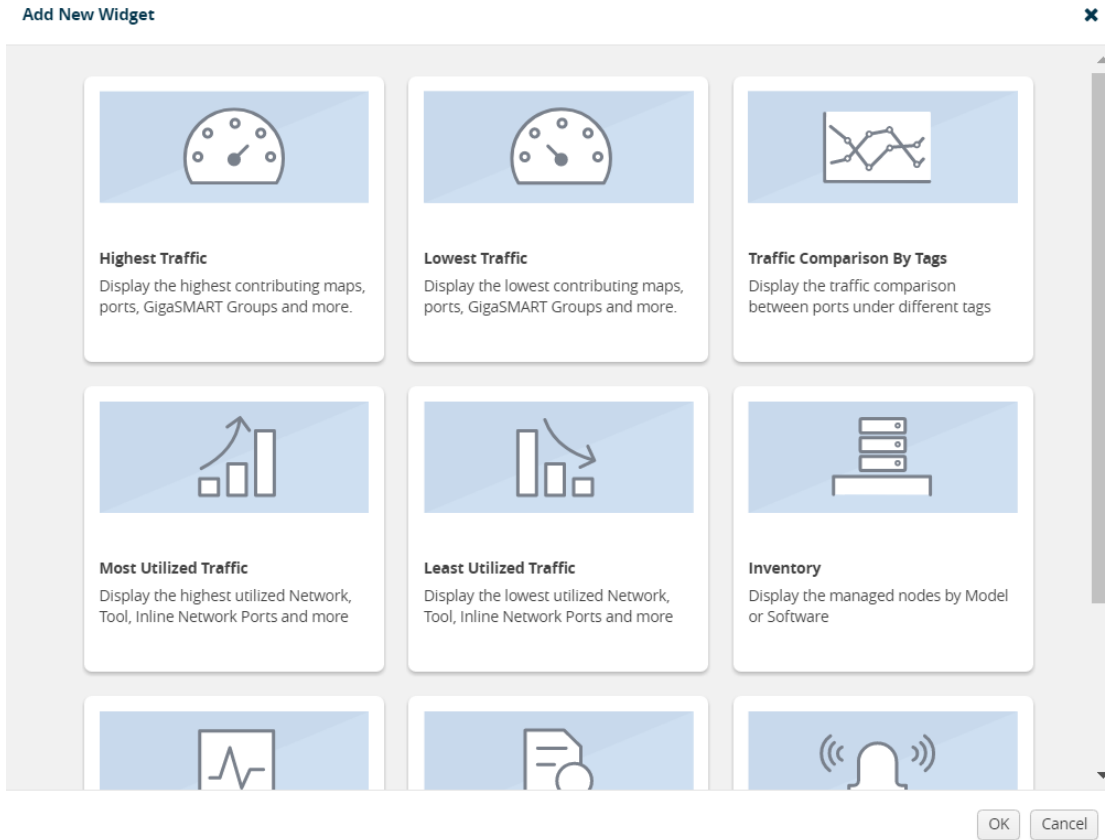


Figure 51: Add New Widget

16. In the Add New Widget window, select **Events** and click **OK**. The Events configuration window is displayed. Refer to [Figure 36: Most Utilized Traffic Configuration](#).

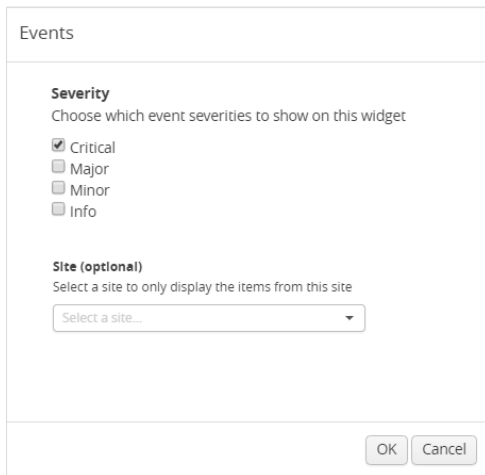


Figure 52: Status Summary Configuration

17. Choose the event you want to view in the widget:

- Critical
- Major

- Minor
- Info

18. (Optional) From the Site drop-down list, select a particular site.

19. Click **OK**.

Health Monitor Dashboard

This chapter describes the Health Monitor Dashboard of GigaVUE-FM.

This chapter covers the following topics:

- [Overview of the Health Monitor Dashboard](#)
- [How to Set Health Monitor Alarm Thresholds and Notifications](#)

Overview of the Health Monitor Dashboard

GigaVUE-FM is the central management appliance for the visibility fabric. Therefore, knowing its current health is important in order to maximize the availability of the appliance. Starting in GigaVUE-FM 3.3, a Health Monitor is available that provides health information about GigaVUE-FM. Refer to [Figure 53: Health Monitor Dashboards](#). The Health Monitor makes it possible helps do the following:

- Detect problems with GigaVUE-FM so that they can be responded to in a timely fashion.
- Provide alerts about issues that could impact the performance, such as CPU or disk over-utilization.

The Health Monitor provides the following monitors:

- CPU utilization
- Memory utilization
- Disk utilization
- Service status



Figure 53: Health Monitor Dashboards

Note: If the percentage displayed in a pie-chart is negligible or less, then it would be difficult to click on the pie-chart arc and view the details.

CPU Utilization

The CPU Utilization Monitor displays overall CPU usage over time, providing information about peak CPU usage. This indicates whether there is sufficient CPU processing power for the currently deployed FM appliance deployment. For example, peak CPU usage above a high-utilization mark of 90 for a long period for more than 30 minutes could indicate that the CPU power of the server is not adequate for GigaVUE-FM to manage the size of the deployed visibility fabric.

The CPU Utilization Monitor displays utilization as a donut and time charts. The donut chart shows percentage of utilized and available CPU. The time chart shows utilization at specific intervals. By clicking on a point in the time chart, you can see the utilization at a specific point in time. In [Figure 54: CPU Utilization Monitor](#), the CPU utilization at 10:49:55 AM is 1.0 percent.

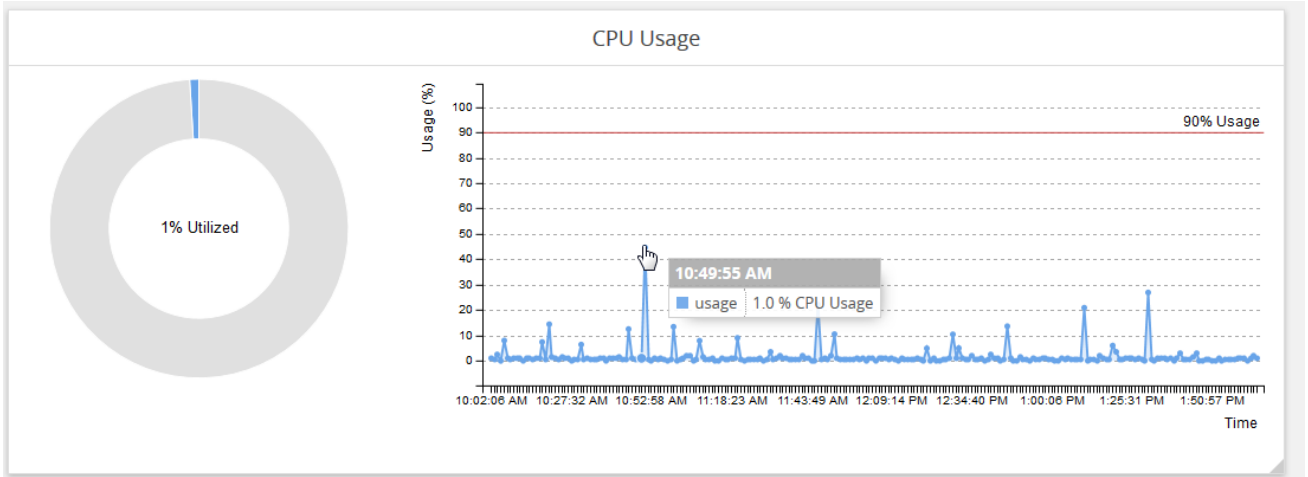


Figure 54: CPU Utilization Monitor

Memory Utilization

The Memory Utilization Monitor displays overall memory usage over time, providing information about peak memory usage. This indicates whether there is sufficient memory to handle the size of the visibility fabric managed by GigaVUE-FM. For example, memory usage above a high-utilization mark over a period for more than 30 minutes could indicate that amount of memory supplied to GigaVUE-FM is insufficient.

The Memory Utilization Monitor display utilization as a dough nut and time charts. The dough nut chart show the percentage of utilized and available memory. The time chart shows utilization as specific intervals. By clicking on a point in the time chart, you can see the utilization at a specific point in time. In [Figure 55: Memory Utilization Monitor](#), the memory utilization at 11:48:49 AM is 17percent.

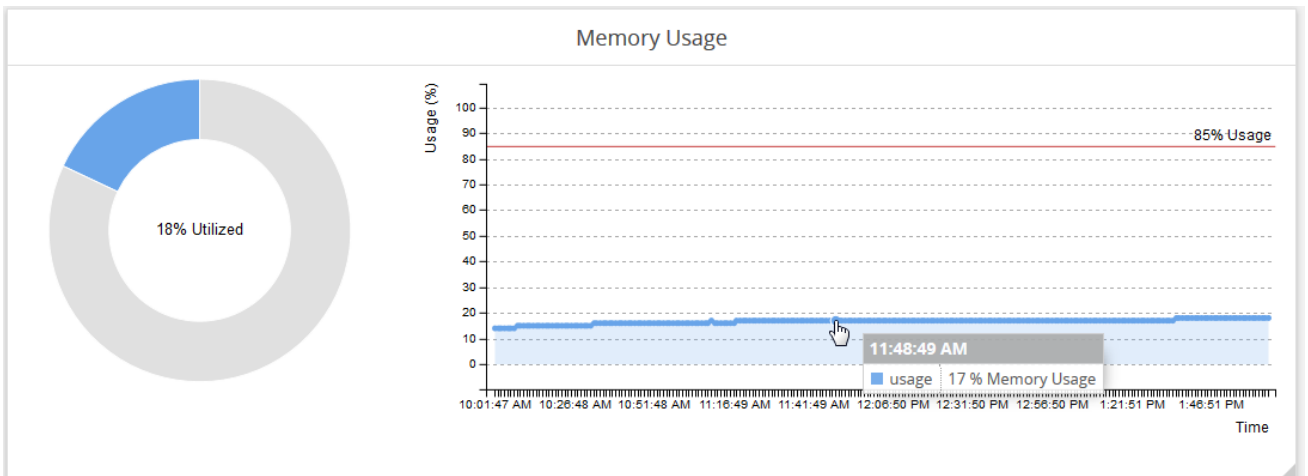


Figure 55: Memory Utilization Monitor

Disk Utilization

The Disk Utilization Monitor displays disk usage levers over time for individual partitions, providing information about peak disk usage for FM logs and FM data. This provides information that can help prevent outages due to disk out-of-space issues. For example, a partition using more than 75 percent of allocated space is generally a warning sign and utilization of over 90 percent of allocated space could justify sending an alert.

The Disk Utilization Monitor display utilization as two bar graphs, one for FM logs and one for FM data, and a time chart. The bar charts show the percentage of disk utilization in the partitions for FM logs and FM data as well as total number of Gigabytes available versus used. The time chart shows utilization as specific intervals for both partition. By clicking on a point in the time chart, you can see the utilization at a specific point in time. In [Figure 55: Memory Utilization Monitor](#), the disk usage at 11:16:01 AM for FM logs is 18.5 percent and the disk usage for FM data is 12%.

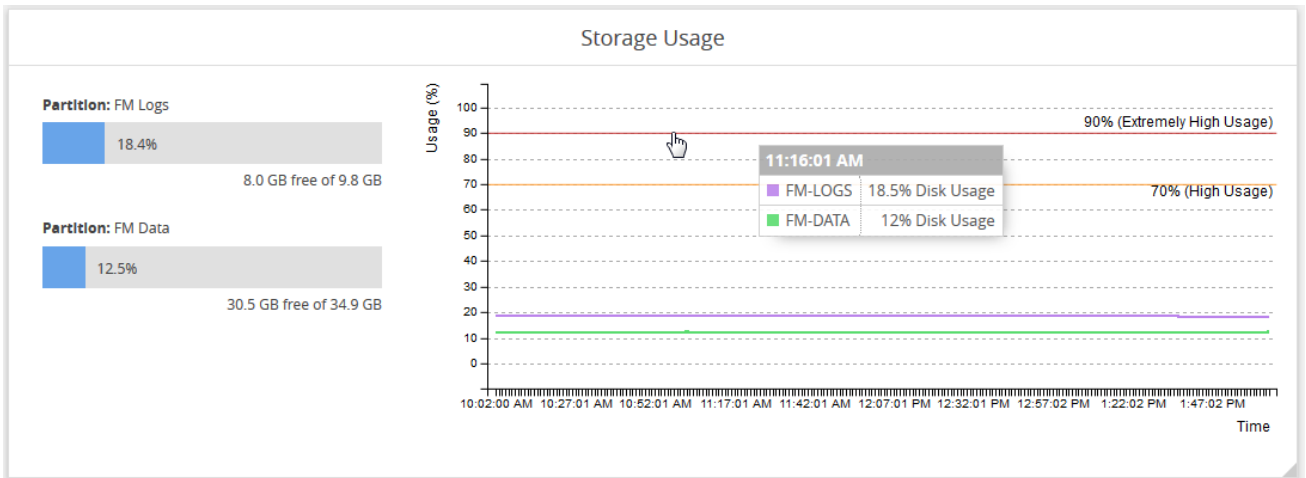


Figure 56: Disk Utilization Monitor

Services

The Service Monitor provides the current status of GigaVUE-FM services, indicating whether they are Up or Down. The services monitored are:

- NetFlow records storage and collection
- Time-series data storage and access
- Fabric configuration storage
- Search engine

In [Figure 57: Services Monitor](#), all of the services are currently up.

Services	
Time-Series Data Storage	✔ Up
Netflow Records Storage	✔ Up
Search Engine	✔ Up
Netflow Records Collection	✔ Up
Fabric Configuration Storage	✔ Up
Time-Series Data Access	✔ Up

Figure 57: Services Monitor

How to Set Health Monitor Alarm Thresholds and Notifications

For CPU, memory, and disk utilization monitoring you can define thresholds that cause an alert if the threshold is exceeded. You can also set up email notifications.

Set Alarm Thresholds

To set thresholds for the Health Monitor, do the following:

1. Click **Dashboard** on the top navigation bar.
2. On the Health Monitor Dashboard page, click **Settings**.
3. On the Health Monitor Thresholds Settings page, select the percentages for CPU, Memory, and Disk utilization that will be the threshold for an alarm.
4. Click **Save**.

After you have set the utilization thresholds, the threshold is displayed as a red line on the time chart of the monitors. For example, in [Figure 58: CPU Utilization with Threshold Set](#), the threshold for CPU utilization is set to 85 percent and the red line is displayed at 85% on the chart. Also, when a specified threshold has been exceeded, the Events page shows an event. For more information about Events, refer to the “Events” section in the *GigaVUE-OS and GigaVUE-FM Administration Guide*.

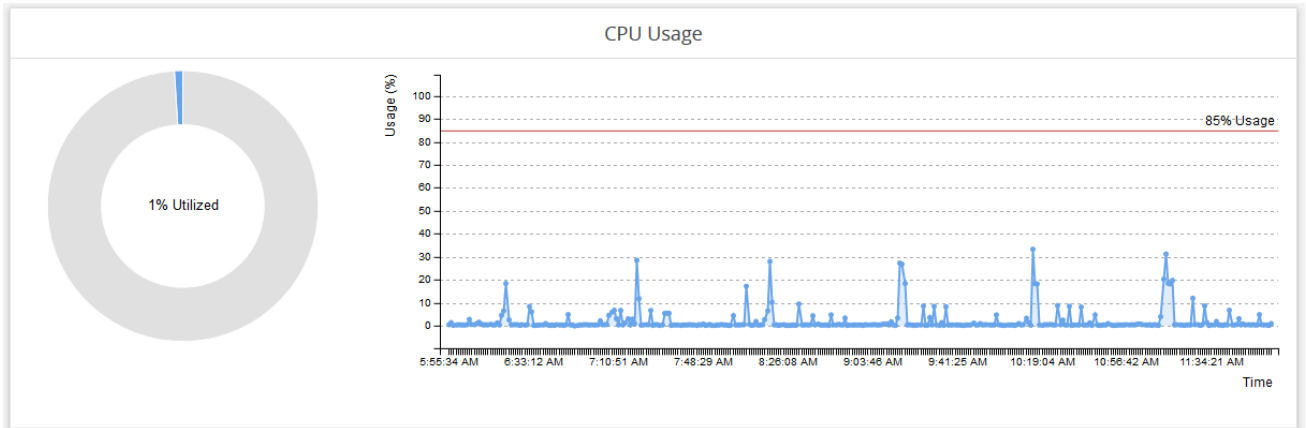



Figure 58: CPU Utilization with Threshold Set

Set Notifications for Health Monitor Thresholds

You can set GigaVUE-FM to send email notifications when ever a utilization threshold is reached by one of the health monitors. To set the threshold notification, do the following:

1. Click  on the top navigation bar.
2. Select **System > Notifications**.
3. Select one or more health monitor notifications.
4. Click **Configure**.
5. Enter the email address for the recipient or recipients for the notifications.
6. Click **Save**.

For more detailed information about Notifications, refer to the “Notifications” section in the *GigaVUE-OS and GigaVUE-FM Administration Guide*.

GigaVUE® Nodes and Clusters

This section introduces the GigaVUE H Series and GigaVUE TA Series of the GigaVUE Traffic Visibility nodes. It also describes node and fabric management activities that you can perform on the physical nodes' embedded GigaVUE-OS from the GigaVUE-FM GUI.

Topics:

NOTE: For device backup/restore details refer to the *GigaVUE-OS and GigaVUE-FM Administration Guide*.

GigaVUE Nodes and Clusters

This section introduces the GigaVUE H Series and GigaVUE TA Series of GigaVUE Traffic Visibility nodes. It also describes their features and functions of the GigaVUE family of nodes. It includes the following major sections:

- [GigaVUE H Series and TA Series Overview](#)
- [About Cluster](#)

GigaVUE H Series and TA Series Overview

The GigaVUE H Series and TA Series delivers performance and intelligence in each of its Traffic Visibility Fabric nodes, with port density and speeds that scale to your needs, from 1Gb to 100Gb. With an intuitive web-based interface (H-VUE or GigaVUE-FM) and a powerful CLI based GigaVUE-OS, the Visibility Fabric is able to replicate, filter, and selectively forward network traffic to monitoring, management, and security tools. The GigaVUE-FM provides a web-based centralized interface to configure and manage all of your GigaVUE nodes through a single pane of glass.




The GigaVUE H Series and TA Series nodes include the following models that run GigaVUE-OS:


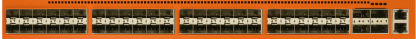


- GigaVUE-HC1
- GigaVUE-HC2
- GigaVUE-HC3
- GigaVUE-TA10
- GigaVUE-TA40
- GigaVUE-TA100
- GigaVUE-TA100-CXP




- GigaVUE-TA200
- Certified Traffic Aggregation White Boxes

Table 11: GigaVUE H Series and GigaVUE TA Series Nodes provides overviews of the GigaVUE H_Series and TA_Series nodes.

Table 11: GigaVUE H Series and GigaVUE TA Series Nodes

<p>GigaVUE-HC1</p>	<ul style="list-style-type: none"> • 1RU Footprint • Built-in GigaSMART functionality • Standard GigaVUE-OS CLI and GigaVUE-FM GUI • Cluster with GigaVUE H Series and GigaVUE TA Series Nodes 	
<p>GigaVUE-HC2</p>	<ul style="list-style-type: none"> • 2RU Footprint • Four front-facing bays for port, TAP, BPS, and GigaSMART front modules • One rear bay for a GigaSMART rear module • Standard GigaVUE-OS CLI and GigaVUE-FM GUI • Cluster with GigaVUE H Series and GigaVUE TA Series Nodes 	
<p>GigaVUE-HC3</p>	<ul style="list-style-type: none"> • 3RU Footprint • Four Module Slots (Bays) • Internal Control Card • Extension Board • Dedicated Cluster Management Port • Standard GigaVUE-OS CLI and GigaVUE-FM GUI • Supports all GigaVUE-HC3 Modules • Cluster with GigaVUE H Series and GigaVUE TA Series Nodes 	
<p>GigaVUE-TA10</p>	<ul style="list-style-type: none"> • 1RU Footprint • Flexible 10Gb/40Gb Modes for 40Gb 	

	<p>Ports</p> <ul style="list-style-type: none"> • Standard GigaVUE-OS CLI and GigaVUE-FM GUI • Cluster with GigaVUE-HD8, HD4, HC2, HB1, and GigaVUE TA Series Nodes 	
<p>GigaVUE-TA10</p>	<ul style="list-style-type: none"> • 1RU Footprint • Flexible 10Gb/40Gb Modes for 40Gb Ports • Standard GigaVUE-OS CLI and GigaVUE-FM GUI • Cluster with GigaVUE H Series and GigaVUE TA Series Nodes 	
<p>GigaVUE-TA40</p>	<ul style="list-style-type: none"> • 1RU Footprint • Flexible 10Gb/40Gb Modes for 40Gb Ports • Standard GigaVUE-OS CLI and GigaVUE-FM GUI • Cluster with GigaVUE H Series and GigaVUE TA Series Nodes 	
<p>GigaVUE-TA100</p>	<ul style="list-style-type: none"> • 1RU Footprint • 32 x 100Gb/40Gb Ports • Standard GigaVUE-OS CLI and GigaVUE-FM GUI • Cluster with GigaVUE H Series and GigaVUE TA Series Nodes 	

GigaVUE-TA100 CXP	<ul style="list-style-type: none"> • 1RU Footprint • 20 100Gb CXP Ports, 8 100Gb QSFP28 Ports • Standard GigaVUE-OS CLI and GigaVUE-FM GUI 	
GigaVUE-TA200	<ul style="list-style-type: none"> • 2RU Footprint • 64 100Gb/40Gb ports • Optional patch or breakout panel support • Cluster with H Series nodes 	
Certified Traffic Aggregation White Box	<ul style="list-style-type: none"> • 1RU Footprint • 10Gb/40Gb Ports • Standard GigaVUE-OS CLI and GigaVUE-FM GUI • Cluster with GigaVUE H Series and GigaVUE TA Series Nodes 	

Notes on TA Series Nodes

- A twenty-four (24) port GigaVUE-TA10 version, called the GigaVUE-TA10A is available with only the first 24 1Gb/10Gb ports enabled. A license is needed to expand a GigaVUE-TA10A to include all 48 1Gb/10Gb ports as well as the four (4) 40Gb ports.
- On the GigaVUE-TA100, only the first 16 out of 32 100Gb ports are enabled. Two port licenses are available to enable an additional 8 or 16 ports to expand from 16 ports to 24 ports or from 16 ports to 24 ports and then to 32 ports.
- The ports on the GigaVUE-TA100 can be used as network, tool, or hybrid ports.
- For more information about the TA Series nodes, refer to the *GigaVUE TA Series Hardware Installation Guide*.

For adding a physical node to GigaVUE-FM, refer to [Configure Physical Nodes](#).

About Cluster

Starting in software version 5.1, you can use GigaVUE-FM to create a cluster. Cluster is created from standalone nodes that are currently managed by GigaVUE-FM. The type of cluster that can be created in this software version is out-of-band.

Any GigaVUE H Series and TA Series nodes can be a part of a cluster. However, a GigaVUE TA Series node cannot be a master node. It can only join a cluster with other GigaVUE H Series nodes.

In addition to creating a new cluster, you can also manage an existing cluster through GigaVUE-FM. You can add nodes to an existing cluster and remove nodes from an existing cluster.

When a new cluster is created, the nodes joining the cluster must be standalone nodes. If a node is initially part of another cluster, it must be removed from that cluster so that it becomes a standalone node, before it can be added to the new cluster.

Refer to the following notes and considerations for all nodes in a cluster:

- must be currently managed by GigaVUE-FM
- must be running software version 5.1, at a minimum
- must be running the same software version
- must be reachable by GigaVUE-FM, that is, it must be online and not have any authentication failures
- for GigaVUE TA Series nodes that have an Advanced Features License, they must be licensed

For information on clustering concepts, refer to [Manage GigaVUE® Nodes and Clusters](#).

Overview of Seed Node

The seed node is a new concept in GigaVUE-FM and is different from the cluster master role.

When a cluster is created, one of the nodes that you have selected for inclusion in the cluster will be deemed as the seed node. The seed node will be used to start the formation of a cluster and will be determined by the cluster master preference settings of the nodes selected for the cluster. For example, if two nodes are selected, and one is a GigaVUE-HC2 with a preference of 60 and the other is a GigaVUE-HD4 with a preference of 80, the GigaVUE-HD4 will be selected as the seed node.

You can override the seed node selected by GigaVUE-FM. However, the seed node must be a node that has the ability to become the master.

Initially, the seed node is the source of the configuration information for the other nodes in the cluster. However, the cluster still consists of a master node, a standby node, as well as normal nodes. With the addition of more nodes to the cluster, a new cluster master may be desired. If the desired master is different from the seed node, the master will then become the source of the configuration information for the other nodes in the cluster.

For creating and managing clusters using GigaVUE-FM, refer to [Create and Manage Clusters](#).

Manage GigaVUE® Nodes and Clusters

This section describes how to add and manage GigaVUE® H Series and GigaVUE® TA Series nodes on a GigaVUE-FM:

- [Configure Physical Nodes](#) describes the process to add, configure and manage GigaVUE nodes through GigaVUE-FM.
- [Create and Manage Clusters](#) describes the process to create a cluster using the wizard, add nodes to a cluster, remove nodes from a cluster, edit cluster parameters, and add stack links.
- [Upgrade Software on a GigaVUE Node or a Cluster from GigaVUE-FM](#) describes the process to upgrade standalone nodes and clusters through GigaVUE-FM.
- [Search for Specific Nodes Using Keywords](#) provides information about each of the standalone nodes and clusters, including a visual indication of each nodes status.
- [Overview Page](#) provides the information on each node connected to the GigaVUE-FM. This section covers the following: [Systems Information](#), [Ports Information](#), and [Traffic](#).
- [Workflows](#) describes how to use the workflow wizards to create four different types of maps. With the wizards, you can create the following types of maps:
 - Out-of-band maps
 - Inline maps
 - Basic out-of-band GigaSMART maps
 - Advanced out-of-band GigaSMART maps
- [Chassis Table View](#) describes the Chassis Table View when managing a node with GigaVUE-FM.
- [Safe and Limited Modes](#) describes Safe Mode and Limited Mode.

Topics:

Configure Physical Nodes

The Physical Nodes page displays a list of physical nodes and clusters that belong to the selected site. It provides information about a device's cluster ID, role, model, connection status, device status, and many other details.

To access physical nodes attached to an instance of GigaVUE-FM, log into GigaVUE-FM. Click **Physical** on the top navigation bar. From the Sites drop-down list, select a specific site to view only those physical nodes and clusters associated to the selected site or select All Sites to view all the physical nodes and clusters managed by GigaVUE-FM.

The Physical Nodes page displays the following information:

Field	Description
Cluster Name	The name of the cluster.
Host Name	The host name of the box.
Node IP	The IP address of the physical node.
DNS Name	The DNS name of the physical node.
Role	The role of the node in the cluster. The role of the node can be one of Master, Standalone, Slave, or Standby.
Model	The type of the GigaVUE H Series model. NOTE: H Series can cluster with TA Series nodes, but G Series nodes can only cluster (stack) with other G Series nodes.
Box Id	The box Identifier of the node.
SW Version	The version number of GigaVUE-FM.
Licensed	The status of the physical node or Advanced Features license.
Device Status	The current health status of the GigaVUE node or cluster. To know about how the device health status is computed, refer to Node Health Status . NOTE: You can monitor the health status of the device by enabling the SNMP notifications. For more information on configuring the email notifications, refer to the "Notifications" section in the <i>GigaVUE-OS and GigaVUE-FM Administration Guide</i> .
Task Status	The status of the upgrade process. When the upgrade process is in progress, the task status displays the number of steps completed successfully out of the total number of steps to be completed. For example, upgrade: step (2/5) Image Fetch Complete. Once the upgrade process is complete, the upgrade status is displayed as Upgrade Success or Upgrade Failure.
Connection Status	The status of the device discovery. The status displayed can be one of Authentication Failed, Connection Failed, or OK.
Last Connected Time	The timestamp when the physical node or cluster was last connected.
Tag	The tag or site name and value associated to the physical node or cluster. The tag names associated to the physical node or cluster are displayed as separate columns. Under the tag or site name, the respective tag or site value is displayed.

NOTE: The columns in the Physical Nodes page can be customized based on the type of content you want to view in the table. For customizing the columns, refer to [Table View Customization](#).

Changes made to the cluster through the CLI are reflected in GigaVUE-FM when it synchronizes with the cluster, which is typically every 5 minutes.

If the latest configuration data is not retrieved from the cluster for more than 30 minutes, a warning is displayed in the cluster Overview page indicating the last time GigaVUE-FM successfully synchronized with the cluster.

To view the last synchronized status, click the cluster and view the status at the top of the Overview page.

Add New Physical Node or Cluster to GigaVUE-FM

You can add physical nodes and clusters to GigaVUE-FM either manually or by importing an Excel spreadsheet. However, before adding a new physical node, ensure that the node credentials are added under the **System > Node Details**.

NOTE: In a cluster configuration, the Normal nodes are seen as Slave nodes in GigaVUE-FM.

Add Nodes Manually

To add physical nodes manually, do the following:

1. Click **Physical** on the top navigation bar.
2. On the Physical Nodes page, click **Add**. The Add Physical Node page displays.
3. Select **Add Manually**.
4. Enter or select the information as shown in the following table:

Field	Description
Node	<p>DNS name or IP address of the node. Click + to add additional nodes or - to remove a node.</p> <div data-bbox="521 1612 1456 1734" style="border: 1px solid #ccc; padding: 5px;"> <p>NOTE: You must add the nodes by their FQDN or hostname rather than IP, especially in case of NAT nodes. This ensures that GigaVUE-FM and device communication is not interrupted when there is a change in the IP address of the node.</p> </div> <p>When adding clusters, use the VIP of the cluster to add. If VIP is not configured, they you must add the master nodes FQDN or IP.</p>

Field	Description
Custom Login Credentials	Check box to enable custom login credentials. If enabled enter the following details: <ul style="list-style-type: none"> • User Name • Password
SNMP Version	The SNMP version to be used to register GigaVUE-FM as a SNMP target on the node.
Node behind NAT	Check box to indicate if the node being added is behind NAT. Refer to Add NAT Behind Nodes for details.
Tags	Select the tag key and the tag value to which the node must be associated to. <div style="border: 1px solid #ccc; padding: 5px; margin-top: 10px;"> NOTE: You can only view tags that are permitted for your role. Refer to the "Tags" section in the <i>GigaVUE Administration Guide</i> for more details. </div>

- Click **Submit** to add the node or nodes to the list of physical nodes GigaVUE-FM is managing.

For standalone nodes, both node IP (Device IP) and cluster ID is the node Address (nodeAddress) provided by the user while adding the node.

NOTE: In GigaVUE-FM version 5.5.01, the Node IP was the actual IP and the Cluster ID was either the DNS ID (if the IP address was resolved) or the Node IP (if the IP address was not resolved).

Add Nodes From an Excel Spreadsheet

You can add nodes to GigaVUE-FM by uploading an Excel spreadsheet that contains a list of the physical nodes that you want GigaVUE-FM to manage. You can create the spreadsheet or use a spreadsheet from a previous export of the nodes. The format of the spreadsheet must have at least a column with the node IPs along with the HTTPS port number (if the port number of the node has been changed using CLI) and the header Node_IP.

Figure 59: Node List Spreadsheet for Import/Export

NOTE: The format of the spreadsheet changed in GigaVUE-FM 3.3. To import a spreadsheet created by GigaVUE-FM prior to GigaVUE-FM 3.3, you can modify the previous spreadsheet or do a new export after upgrading to the current version of GigaVUE-FM. An example of a spreadsheet is shown in [Figure 59: Node List Spreadsheet for Import/Export](#).

To add physical nodes by importing from a spreadsheet, do the following:

- Click **Physical** on the top navigation bar.

2. On the Physical Nodes page, click **Import**.

The Add Physical Node page displays with the **Import from Excel** option automatically selected. The page displays an area for selecting or dragging and dropping a file.

3. Drop an Excel file onto the page or click **Select File** to upload the file.

The page displays the list of IP address.

4. Select the nodes to add to GigaVUE-FM.

5. Click Submit to add the node or nodes to the list of Physical Nodes GigaVUE-FM is managing.

NAT Behind Nodes

GigaVUE-FM can manage nodes and clusters that use Network Address Translation (NAT) for IP address conversion. GigaVUE-FM identifies the nodes behind NAT based on the **Node Behind NAT** option which you must select at the time of adding the nodes. Refer to [Add Nodes Manually](#).

Prerequisites

In order for GigaVUE-FM to manage the devices and clusters that are behind NAT:

- GigaVUE-FM must be running software version 5.7 or higher.
- Devices must be running software version 5.3 or higher.
- Devices must be assigned NAT IP and Fully Qualified Domain Names.
- Domain name server and default search domain must be configured in GigaVUE-FM.

Add NAT Behind Nodes

When managing clusters behind NAT, GigaVUE-FM does not know the NAT IP of the members in the cluster. You cannot also configure the NAT IP of the members. GigaVUE-FM only identifies the private IP of the nodes through the API. Therefore, for device specific operation, GigaVUE-FM uses host names to connect to the nodes. You must therefore configure the domain name server and default search domain in GigaVUE-FM. Refer to the "NAT Configuration" section in the *GigaVUE-OS and GigaVUE-FM Administration Guide*. If you do not configure the domain name server and search domains, then it may lead to failure in node specific operations.

NOTE: When adding nodes, ensure the following:

- Select the **Node behind NAT** option for a node that is behind NAT.
- Do not select the **Node behind NAT** option for a normal node.

If you fail to perform the above operations, then you may experience inconsistency in managing the nodes.

Refer to the “NAT Configuration” section in the *GigaVUE-OS and GigaVUE-FM Administration Guide* for details.

Limitations

Though GigaVUE-FM can manage nodes behind NAT from software version 5.3, SNMP traps, Syslog messages and event notifications will not be pushed from the node to GigaVUE-FM. This is because GigaVUE-FM registers its eth0 address as target address on the nodes to receive the notifications but the nodes behind NAT will not be able to reach GigaVUE-FM by its eth0 IP. These limitations are not applicable for node version 5.7 and above.

NOTE: Refer to the “NAT Configuration” section in the *GigaVUE-OS and GigaVUE-FM Administration Guide* for details.

Cluster Discovery Behavior

GigaVUE-FM does not detect individual nodes that were part of a cluster, if the cluster was dismantled using the CLI. GigaVUE-FM always reaches the cluster by its virtual IP address (if configured). When a cluster is dismantled through the CLI, the virtual IP address of the cluster will no longer be available and the cluster is therefore marked as unreachable. There is no change in detecting node additions, removals, or membership changes performed from CLI.

ARP/NDP Timer Settings

The Address Resolution Protocol (ARP) or the Neighbor Discovery Protocol (NDP) timer specifies the aging time on the IP interface. The ARP timer is used for IPv4 addresses and the NDP timer is used for IPv6 addresses. The timer is configurable from 3 to 30 seconds. The default is 30 seconds. When an IP interface is configured, ARP/NDP requests are sent to the IP interface to find the gateway MAC address. In response, the gateway sends an ARP/NDP reply. The control card tries to match the IP address of the IP interface with the IP address of the ARP/NDP message received. If a match is found, the ARP/NDP status changes to resolved (otherwise the ARP/NDP status is not resolved).

Once the ARP/NDP status is resolved, the ARP/NDP timer of the IP interface controls the interval at which an ARP/NDP request is sent to the gateway to detect if the gateway is reachable or not.

You must enable the IP Gateway Status SNMP trap to send SNMP notifications when the ARP/NDP status changes. To enable SNMP notifications, refer to the following: [Enable or Disable Events for SNMP Notifications](#)

Change the ARP/NDP Timer Settings

The default ARP/NDP timer value is 30 seconds. To change the timer setting at the node-level:

1. On the top navigation pane, click **Physical**.
2. In the Physical Nodes page, select the node for which you want to change the ARP/ NDP timer setting.
3. Go to **Settings > Global Settings > ARP/NDP**.
4. Click **Settings**.
5. In the ARP/NDP Settings page, choose the required **ARP Refresh Time Interval** or the **NDP Refresh Time Interval** in seconds.
6. Click **OK**.

The ARP Entries table and the IPv6 Neighbor Entries table dynamically refresh to display information such as the IP address and Hardware address mapping, aging, state, and interface details.

Click **Clear > Clear ARP Entries** or **Clear > Clear IPv6 Neighbor Entries** to remove the entries from the tables.

Enable Gratuitous ARP on Management Interface

A Gratuitous ARP is an Address Resolution Protocol response that is sent without an ARP request. The Gratuitous ARP response is sent as a broadcast in the network. It is a mechanism by which a device can announce or update its IP address to MAC address mapping. This helps the neighboring devices to discover the device that has sent the Gratuitous ARP response and forward subsequent packets to the device without any delay.

You can enable the Gratuitous ARP on the management interface of a GigaVUE H Series or GigaVUE TA Series device. Ensure that the management interface is configured with static IP address. A Gratuitous ARP response is sent to the network when:

- the device boots up.
- the IP address of the device changes.
- the link state of the management interface comes up.

NOTE: You cannot enable Gratuitous ARP on the management interface that is configured with DHCP.

To enable Gratuitous ARP on a management interface:

1. On the top navigation bar, click **Physical**.
2. Click on a node on which you want to enable Gratuitous ARP. The Overview page of the node appears.

3. In the left navigation pane, select **Settings > Interface > Protocol Configuration**.
4. Select the box ID on which you want to enable Gratuitous ARP, and then click **Edit**.
5. Select the **Gratuitous ARP** check box.
6. Click **Save**. The Gratuitous ARP is enabled on the management interface of the device.

Enable or Disable Events for SNMP Notifications

To enable or disable events for SNMP Notifications:

1. From the device view, go to **System > Settings > Global Settings > SNMP Traps**.
2. Click **Trap Settings**. The Edit SNMP Trap Settings page opens.
3. Select or clear the **Enable** check box for the SNMP trap that you want to enable or disable.
4. Click **OK**.

SNMPv3 Support


Starting with software version 5.4 GigaVUE-FM creates an SNMPv3 user during the upgrade process from version 5.3. The SNMPv3 user is created with same authentication and privacy settings previous held.

NOTE: SNMPv3 support is only available on FM software version 5.4 user and SNMPv3 users created by FM cannot be modified by users.

Enable SNMPv3 on Nodes

You can enable SNMPv3 from the node addition page, If node version 5.4 or higher and SNMPv3 is selected, the FM registers itself as a SNMPv3 trap receiver. If the SNMPv3 is chosen and the node version is 5.3 or below then, FM registers itself as a SNMPv2 trap receiver. When this occurs FM reports an event that FM does not support SNMPv3 on the node with 5.3 or lesser version.

Enabling SNMPv3 During Upgrade

1. Select  on the top navigation bar.
2. On the left navigation pane, select **System > Credentials**. The Credentials page displays a listing of the nodes and SNMP versions.
3. Select a node to upgrade, and click **Edit**.
4. Select SNMP version - SMNPv3
5. Click **Save**.

Enabling SNMPv3 on a New Node

1. Select **Physical**> **Add**. The Add Physical Node displays.
2. Enter **Node Name**.
3. Click **Enable**.
4. Enter **Username** and **Password**.
5. SNMP Version: SNMPv3.
6. Click **Submit**.

Create and Manage Clusters

This section describes the GigaVUE-FM clustering. Refer to the following sections for details:

- [About Cluster](#)
- [Create Clusters](#)
- [Support for Cluster Types](#)
- [Regular Cluster Formation Workflow](#)
- [Edit Cluster](#)
- [Add Nodes to a Cluster](#)
- [Remove Nodes from a Cluster](#)
- [Edit Cluster Parameters](#)
- [Check Cluster Status](#)

About Cluster

A cluster consists of multiple GigaVUE-OS nodes operating as a unified fabric such that packets entering the cluster on one node can be sent to a destination port on any other node. You set up packet distribution using the standard box ID/slot ID/port ID format, allowing maps to distribute traffic to any port in the cluster.

Figure 60: [Sample Cluster](#) illustrates a sample cluster of GigaVUE-OS nodes.

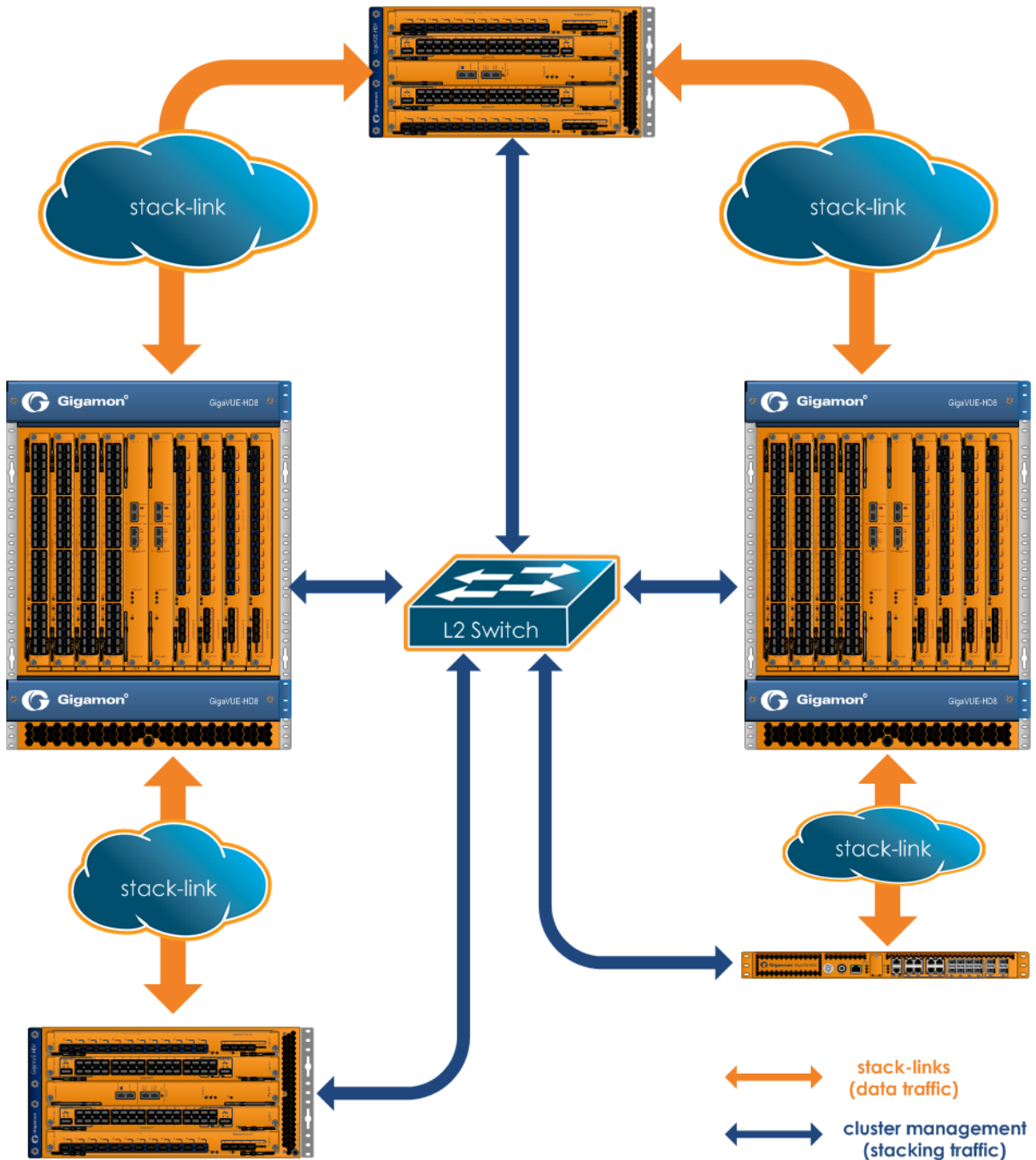


Figure 60: Sample Cluster

Cluster Node Limit

Any GigaVUE-OS nodes can join other nodes in a cluster. The GigaVUE-HC3, GigaVUE-HC2, GigaVUE-HC1, GigaVUE-HB1, and GigaVUE TA Series nodes, including Certified Traffic Aggregation White Box (white box), can be included in the same cluster. Starting in software version 4.5, the maximum number of nodes supported in a cluster is 32. For details, refer to [Cluster Scaling](#).

In addition, there is another independent limit, which is for the maximum number of line cards supported in a cluster, across all of the nodes in the cluster. This limit is determined by cost units. Cost units are based on the total number of line cards, line card types, and chassis type. Cost units measure the resources that a node needs in a cluster. The higher the cost unit, the more resources are needed to manage the node.

The following table has examples of line card and chassis types, and their cost units.

Line Card Type or Chassis	Cost Unit
GigaVUE-HC1 Chassis	1
GigaVUE-HC2 Chassis	1
GigaVUE-HC2 Chassis with Control Card version 2 (HC2 CCv2)	1
GigaVUE-HC3 Chassis	1
GigaVUE-HC3 Chassis with Control Card version 2 (HC3 CCv2)	
GigaVUE-TA10	1
GigaVUE-TA40	1
GigaVUE-TA100	1
GigaVUE-TA100-CXP	
GigaVUE-TA200	1
Certified Traffic Aggregation White Box	1

For example, if a GigaVUE-HD8 has one C02X08 line card, one GigaSMART line card, and one Q02X32 line card (other), the cost units are $3 + 2 + 1 = 6$. (Replace it with example HC3)

NOTE: The cost unit for a GigaVUE-HC2 is always 1, regardless of how many modules are installed.

The following table displays the cost unit maximum depending on the nodes in the cluster.

Cluster Nodes	Cost Unit Maximum
If any node in the cluster has one or more PRT-H00-X04G44 line cards	127
If there is a GigaVUE-HB1 in the cluster	127
All others	255

Therefore, the largest cluster supported is determined either by the maximum number of nodes (32) or by the cost unit maximum, whichever is reached first.

Cluster Scaling

The maximum number of nodes and map rules supported in a cluster is as follows:

Table 12: Maximum Number of Nodes and Map Rules Supported in a Cluster

When a Cluster is Configured with:	Number of Nodes	Maximum Map Rules
Out-of-Band Cluster Management	32	38000
Inband Cluster Management	16	38000

The maximum number of map rules supported in a cluster apply to all nodes in the cluster including GigaVUE H Series nodes: GigaVUE-HC3, GigaVUE-HC2, GigaVUE-HC1, and GigaVUE-HB1, and GigaVUE TA Series nodes: GigaVUE-TA1, GigaVUE-TA10, GigaVUE-TA40, GigaVUE-TA100, and GigaVUE-TA200, including Certified Traffic Aggregation White Box (white box).

Cluster Topologies

The following cluster topologies are supported:

- star
- daisy-chain
- tree

Separate Paths for Cluster Control and Stack Traffic

There are two types of clustering: out-of-band and inband.

The nodes in a cluster are constantly communicating with one another, exchanging heartbeats to check on one another's status, exchanging configuration information so that changes made on the master node are propagated to other nodes, and making changes to cluster roles based on changes in status.

GigaVUE-OS separates cluster control traffic from the actual flow of packets from ingress ports on one node to egress ports on another for the two types of clustering, as follows:

<p>Out-of-Band Clustering on Mgmt Ports</p>	<p>With out-of-band clustering, cluster control traffic is carried out-of-band on its own network as follows:</p> <ul style="list-style-type: none"> • GigaVUE-HC3 nodes use the Mgmt port (eth0) or the two dedicated STACK ports (eth2). • GigaVUE-HC2 nodes use the Mgmt port (eth0) or the dedicated cluster Mgmt port (eth2). • GigaVUE-HC1 nodes use the Mgmt port (eth0) or the dedicated cluster Mgmt port (eth2). • GigaVUE-HB1 nodes use the Mgmt port (eth0). • GigaVUE-TA1 nodes use the Mgmt port (eth0). • GigaVUE-TA10 nodes use the Mgmt port (eth0). • GigaVUE-TA40 nodes use the Mgmt port (eth0). • GigaVUE-TA100 nodes use the Mgmt port (eth0). • GigaVUE-TA200 nodes use the Mgmt port (eth0). • GigaVUE-OS on white box nodes use the Mgmt port (eth0). <p>Cluster Management port(s). Using the cluster management port(s) lets you route cluster control traffic over a separate network from the network used to access the Mgmt port. This prevents cluster control traffic from overloading the traffic used to access the Mgmt port.</p> <p>Mgmt Port (eth0). You can also select to use the standard Mgmt port for cluster control traffic. In this implementation, cluster control traffic uses the Mgmt port's Ethernet connection.</p>
<p>Inband Clustering on Stack-Links</p>	<p>Stack-links are used to create a stacking connection between two GigaVUE nodes in a cluster. Stack-links carry traffic from network ports on one node to tool (or GigaSMART) ports on a destination node.</p> <p>With inband clustering, cluster control traffic is carried inband through the stack-link. Stack-links can be constructed out of individual stack ports, for example, a 40Gb port on a PRT-HC0-Q06 or PRT-HC0-X24 for GigaVUE-HC2, or stack GigaStream. You decide which to use with the gigastream and ports arguments in the stack-link command. For example, the following command creates a stack-link between the q1 40Gb port on box 1/slot 1 and the q1 port on box 2/slot 7:</p> <p>(config) #stack-link alias biglink between ports 1/1/q1 and 2/7/q1 comment "40Gb Stack"</p>

Stack links are supported at speeds of 10Gb, 40Gb, and 100Gb. Refer to the *Hardware Installation Guide* for each GigaVUE node for information on stack link support. Keep in mind that because of the 10Gb port density offered by GigaVUE-OS nodes, using only one 10Gb port for a stack-link could cause a serious bottleneck. A stack GigaStream dramatically increases the bandwidth available for stack-links, letting you connect GigaVUE-OS nodes in a cluster and still take advantage of the 10Gb port density. Alternatively, nodes with 40Gb or 100Gb ports can take advantage of their high bandwidth for stack-links.

When using stack GigaStream for stack-links, you must create a stack GigaStream on each side of the stack-link and each side must consist of the same number of ports running at the same speed.

About Cluster Roles

Communication with a GigaVUE-OS cluster is accomplished using a master virtual IP address assigned to the cluster as a whole. Physically, the virtual IP address resolves to only a single master node at any one time. However, the master role on the GigaVUE-OS node is not statically assigned to a single node. Instead, any node (except GigaVUE TA Series and the nodes residing on a different management subnet) in the cluster can take on the master role if the situation requires it (for example, if both the master and the current standby nodes go down).

When a new node becomes the master, it takes ownership of the virtual IP address used for master access to the cluster. Because all of the nodes in the cluster share the same database, this transition takes place seamlessly, ensuring that the cluster survives the failure of one or more nodes.

The virtual IP address is assigned to the primary control card in the configuration jump-start wizard:

Step xx: Cluster mgmt virtual IP address and masklen? [0.0.0.0/0]

Each node in the cluster is performing one of the following roles at any given time:

- **Master** – This node has possession of the cluster's virtual IP (VIP) address and takes responsibility for dispatching commands to the entire cluster.
- **Standby** – This node takes over the master role in the event of a failure on the node currently holding the role.
- **Normal** – These nodes perform normal GigaVUE operations with minimal cluster responsibilities. However, they, too, have a complete copy of the cluster's database. When a master fails and standby is promoted to be the new master, an election process takes place automatically between all normal nodes, ensuring that a new standby is found.

Setting a Node's Priority in the Master Election Process

Clusters of GigaVUE-OS nodes perform a master election in the following situations:

- Cluster reload
- Master or standby node failure

In either of these cases, a new node is selected to perform the necessary role(s). You can set the **cluster master preference** for each individual node in the cluster to specify how likely the node is to claim a master/standby role. Higher values are more likely to claim the master/standby role; lower values are less likely.

Use preference settings from 10 to 100 for master, standby, and normal roles. Use preference settings from 1 to 9 for normal nodes that are excluded from taking the master or standby role.

In software version 4.5, the preference cannot be set to zero. A node with a preference of 0 in an earlier software version will be changed to 1 after upgrading to 4.5 or higher.

GigaVUE-OS sets defaults for the **preference** argument based on the type of control card in use. If you choose to change a node's **preference** setting, it is generally preferable to set higher priorities for nodes with more processing power. GigaVUE-HC3, or GigaVUE-HC2 nodes provide the most processing power, followed by GigaVUE-HC1 nodes, followed by GigaVUE-HB1 or GigaVUE TA Series nodes.

NOTE: All GigaVUE TA Series nodes including the white box, will automatically be added to a cluster with preference set to 1 because any Traffic Aggregator can never take the role of, or be eligible to be, the master node.

Note:

In addition, in an event of a cluster reboot, any GigaVUE TA Series node in a cluster may show as standby for a couple of minutes while the cluster is coming up from the reboot cycle. However once the cluster is up and running, none of the GigaVUE TA Series nodes can be a standby.

About the "Unknown" Cluster Role

In addition to the standard roles in [About Cluster Roles](#), the system may occasionally report a node operating with an **unknown** cluster role. A node with an unknown cluster role is no longer being actively managed by the master node.

When a node that was formerly part of a cluster transitions to an **unknown** cluster role, its database will typically be out of synchronization with the master node's. You can restore the node to the cluster by using the **reset factory keep-all-config** command, followed by a reboot, and running **configuration jump-start** to rejoin the cluster with a clean local database.

Sample Cluster Control Connections

The GigaVUE-OS provides a flexible approach to cluster control traffic, allowing you to route it over cluster management or Mgmt ports. The ports available and their eth x designations vary by control card version and node type, as summarized in the following table:

Control Card/Node Type	Possible Cluster Control Ports	Deployment Models
HCCv2 Control Card	Cluster Mgmt (eth2) or Mgmt (eth0)	<ul style="list-style-type: none"> Cluster Mgmt (eth2) and L2 switch Mgmt (eth0) and L2 switch
GigaVUE-HC3 Node	STACK (eth2) or Mgmt (eth0)	<ul style="list-style-type: none"> Cluster Mgmt (eth2) and L2 switch Mgmt (eth0) and L2 switch
GigaVUE-HC2 Node	Cluster Mgmt (eth2) or Mgmt (eth0)	<ul style="list-style-type: none"> Cluster Mgmt (eth2) and L2 switch Mgmt (eth0) and L2 switch
GigaVUE-HB1 Node	Mgmt (eth0)	<ul style="list-style-type: none"> Mgmt (eth0) and L2 switch <div style="border: 1px solid black; padding: 5px; margin-top: 10px;"> <p>NOTE: When including a GigaVUE-HB1 in a cluster, it is required to use one port for both node and cluster management.</p> </div>
GigaVUE TA Series Nodes	Mgmt (eth0)	<ul style="list-style-type: none"> Mgmt (eth0) and L2 switch

Sample Cluster Control Configurations

Cluster control traffic can also be sent over the cluster Mgmt (eth2) ports to an L2 switch (only for the GigaVUE-HC3, GigaVUE-HC2, and GigaVUE-HC1 nodes).

Nodes in the same cluster must use the same cluster interface. For example, if there is a GigaVUE-HB1 or a GigaVUE-TA10 in the cluster, all nodes in the cluster must use eth0.

Zeroconf for Cluster Management Ports

By default, cluster management ports use zero configuration networking (zeroconf) to establish networking settings. This eases configuration when establishing clusters using the cluster management port(s).

Keep Cluster Management Ports Connected!

IMPORTANT: Clusters implemented using the cluster management ports for cluster control traffic must ensure that the cluster management ports of all nodes in the cluster are connected at all times. This prevents a situation where multiple masters claim the management VIP address, resulting in the inability to connect to it at all.

Sample Stack-Link Configurations

This section illustrates some sample configurations for the data-carrying stack-links in a cluster, including a star configuration and a daisy-chain using a GigaStream. You can see a combination of star and daisy-chain in [About Cluster](#).

IMPORTANT: Ensure that you do not cable the stack-links in a loop. Use a star or daisy-chain configuration, as follows:

Star Configuration

Use a GigaVUE-OS node as the hub in a star configuration. This makes it easy to create a star configuration that maximizes traffic distribution efficiency. With a star configuration, no destination is further than two hops away. Note that the following image only shows the stack-link connections and not the cluster control connections from the control cards.

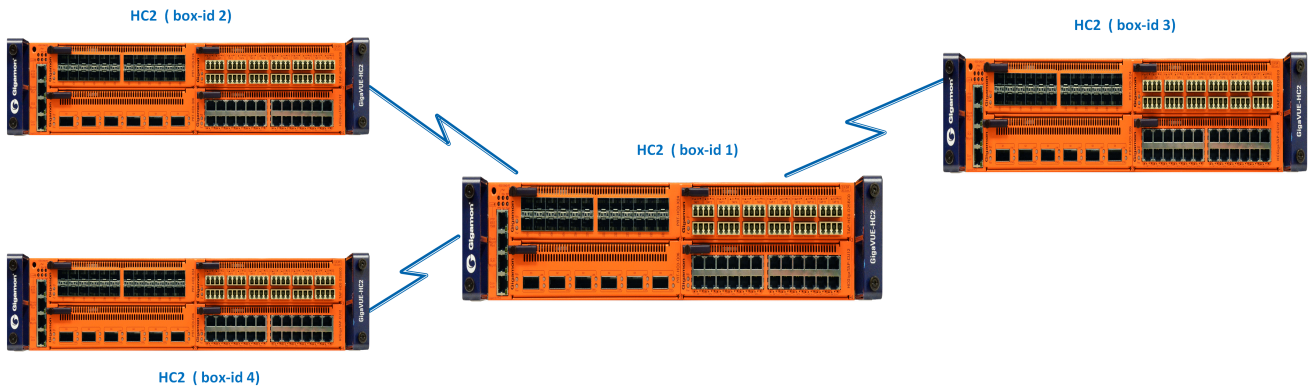


Figure 61: Star Configuration

Daisy-Chain Configuration Using GigaStream for Stack-Link

You can connect two GigaVUE-OS nodes together in a daisy-chain, for example, using any 10Gb line card port. Since there can be up to 256 10Gb ports on a single GigaVUE-HD8 node, the stack-link needs enough bandwidth to handle expected cross-node traffic volume. Create a stack GigaStream out of up to 24x10Gb (PRT-HC3-X24)16x10Gb (PRT-H00-Q02X32) or 8x40Gb (PRT-HD0-Q08) ports to handle expected cross-node traffic loads



Figure 62: Daisy-Chain Configuration using GigaStream for Stack-link

Creating Clusters: A Roadmap

Setting up a cluster consists of the major steps shown in [Figure 63: Creating Clusters: Major Steps](#).

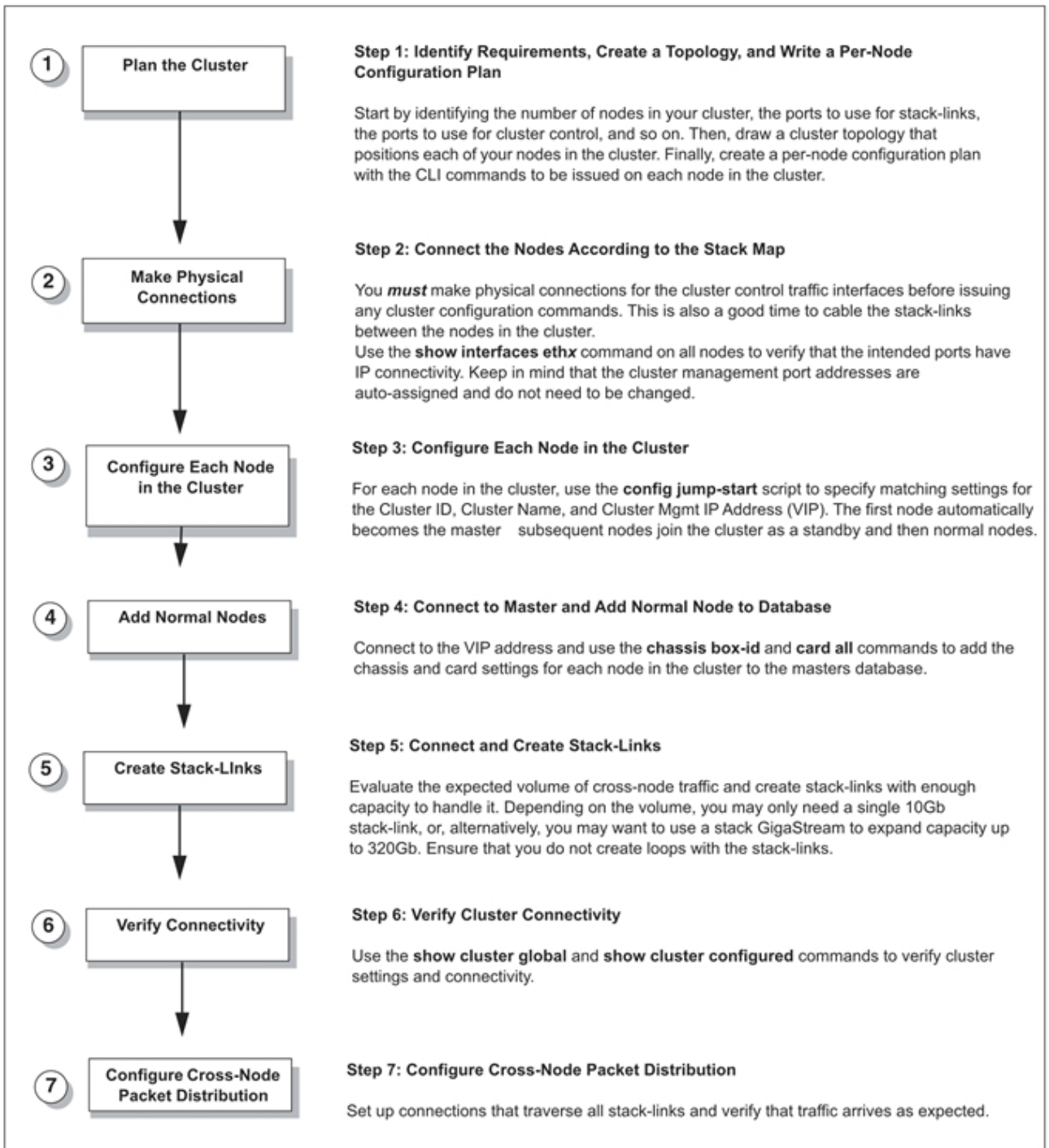


Figure 63: Creating Clusters: Major Steps

Cluster Rules and Recommendations

When creating clusters, keep in mind the following rules and recommendations:

- Before joining an existing GigaVUE node to a cluster, it is recommended to use the **no traffic all** or **reset factory** command to clean up existing traffic-related configuration. For example, in a cluster there is one master node and the other nodes are GigaVUE-TA nodes. When the master node is removed from the cluster, the GigaVUE-TA nodes moves to the unknown state. If another master node joins the cluster with a different database, the GigaVUE-TA nodes that are existing in the cluster will remain in the unknown state.
- Remove all physical loops before enabling the cluster. An accurate cluster topology will help with this. The GigaVUE-OS node automatically detects and prevents configurations that would cause loops, but its best to avoid them in the first place.
- Star configurations offer the most efficient use of bandwidth. In general, use one GigaVUE-OS node at the hub of your star and then connect spokes off of that.
- Create stack-links with enough capacity to match expected cross-node traffic. For example, you can use a 40Gb port on a PRT-HD0-Q08 line card or PRT-H00-Q02X32 line card or create a GigaStream out of stack ports and use that as a stack-link. GigaStream can use up to 16x10Gb (PRT-H00-Q02X32) or 8x40Gb (PRT-HD0-Q08) ports for the GigaVUE HD Series node and 24x10Gb (PRT-HC0-X24) or 6x40Gb (PRT-HC0-Q06) for the GigaVUE-HC2 node.
- Configure only the stack type ports that you will use in the stack-link configuration. Loops can be created if stack type ports are configured but then not used in a stack-link.
- The first node added to the cluster becomes the master. This is important when creating a new cluster using an existing, already-configured node and a new node. If you want to keep the configuration on your existing node, use it as the first node in the cluster. This way, the existing node becomes the master and the new node inherits its configuration, preserving your existing settings. GigaVUE TA Series nodes are an exception since they cannot be the master.
- When joining a new node to an existing cluster, give the new node a lower precedence than the master. Once the database has synchronized to the existing master, you can increase the precedence to make the newly joined node the master, if that is required.
- Connecting two masters to the same cluster is not supported. This is why you must make physical connections for the cluster control traffic interfaces before issuing any cluster configuration commands. Because the first node added to a cluster becomes the master, configuring cluster settings before physically connecting the cluster control network results in a situation with multiple masters attempting to connect to the same cluster.

NOTE: Merging clusters is not supported.

- GigaVUE TA Series and Certified Traffic Aggregation White Box nodes in a cluster can have tool, network, hybrid, and stack ports.

- A GigaVUE TA Series node cannot be a master node. It can only join a cluster with other node types, such as GigaVUE-HC3, GigaVUE-HC2, or GigaVUE-HC1.
- A GigaVUE TA Series node cannot be a standby node either. If the cluster has one master and all other nodes are GigaVUE TA Series nodes, the cluster will not have a standby.
- Since a GigaVUE TA Series node can never be a master or a standby in a cluster, a database restore is not possible. The best option is a text restore that has the information of the other nodes in the cluster removed from the text backup of the GigaVUE TA Series.
- If GigaVUE-HC1 and GigaVUE-HC3 devices are member nodes of a scaled cluster of approximately 10K map rules, then the following sequence of steps should be avoided:
 - a. Removal of nodes from the cluster.
 - b. Reload the removed node with 10K map rules.

If the above steps are done, the nodes may get locked out and you will not be able to log in to the devices. To remove a GigaVUE-HC1 or GigaVUE-HC3 node from a cluster and use it as a standalone node:

- Remove the node out of cluster.
- Erase the configuration using the "no traffic all" command on the standalone node.
- Reload the node.

GigaVUE-TA Series and GigaVUE-HC3 Clustering Recommendations

The following recommendations are for GigaVUE-TA Series and GigaVUE-HC3 nodes in a cluster:

- When a GigaVUE-TA Series or GigaVUE-HC3 is connected to a node of a different type, ports may not become operationally up until the stack-links are created between the stack ports. To ensure the ports become operationally up:
 - Configure the specified ports as stack ports.
 - Configure the stack-link between the stack ports.

Cluster Rules

Clusters must adhere to the following rules:

Rule

All GigaVUE-OS nodes in a cluster must run the same version of the GigaVUE-OS software, including the major and minor version numbers.

Each GigaVUE-OS node in a given cluster must share the same **Cluster ID**, **Cluster Name**, and **Cluster Mgmt IP Address**.

Rule

You can configure these settings in the **config jump-start** script, or, alternatively, use separate **cluster** commands to set them. When adding a node present on the same IP subnet to an existing cluster, so long as you specify the cluster ID correctly, the cluster Mgmt IP address (VIP) will be synchronized from the master automatically.

Cluster management ports must be on the same IP subnet.

Each GigaVUE-OS node in a cluster must have its own unique box ID. The box ID is assigned to a chassis from the master with the **chassis box-id <box ID> serial-num <serial number>** command (). Keep in mind that if you are using GigaSMART trailers to identify ingress ports, only box IDs from 1-64, inclusive, are supported.

You can only connect optical-to-optical stack-links. Stack-links must be at least 10Gb. In addition, they must use the same transceiver types, such as LR-to-LR, or SR-to-SR.

Use a stack-link between different types of GigaVUE-OS nodes so long as the medium, speed, and number of ports involved is the same on both sides.

Best Practices for OOB Clusters with IGMP Snooping

The following are best practices for out-of-band (OOB) clusters if Internet Group Management Protocol (IGMP) snooping is enabled in the cluster.

Clustering relies on the IGMP protocol to discover peer nodes and to communicate with them. Switches often have IGMP snooping enabled by default, which will filter IGMP packets from ports that do not have periodic IGMP membership reports. This can cause IGMP packet drops in out-of-band clusters.

Refer to [About IGMP Snooping in a Cluster](#) for more information. Also refer to the following best practices:

- allow Internet Group Management Protocol (IGMP) traffic by using an IP filter chain. Refer to [Allow IGMP Traffic](#).
- enable an IGMP querier. Refer to [Enable an IGMP Querier](#).

These best practices result in the following:

- hostnames being properly displayed in CLI commands that display cluster information such as **show cluster global brief**
- nodes joining clusters faster, especially nodes that are not capable of becoming a master, such as GigaVUE TA Series nodes
- no multiple masters being created in an out-of-band cluster. This can occur when a node that is capable of becoming a master is not able to see the current master and hence elects itself as a master.

About IGMP Snooping in a Cluster

IGMP snooping is a networking feature that monitors IGMP membership reports received from different ports on a networking switch and learns the ports to which multicast groups belong. When a port stops sending membership reports about a multicast group, the switch will stop forwarding the group's traffic to the port.

An IGMP querier is a router (or switch) feature that periodically queries the network for multicast group interests. If a node on the network belongs to a certain multicast group, it responds to the queries, the router then records or refreshes its record of the node's interest in the traffic for the group, and the router forwards traffic to the network towards the node. The switches on the network with IGMP snooping enabled also learn from the responses and maintain their records about the nodes' interests in groups and forward traffic accordingly.

Hostnames are detected using Multicast Domain Name System (mDNS) packets, which are in multicast group 224.0.0.251.

An IP filter is a chain of rules for the treatment of packets. Refer to the *"Using IP Filter Chains for Security"* section in the *GigaVUE-OS-CLI Reference Guide*.

Allow IGMP Traffic

If IP filtering is enabled (and IGMP snooping is enabled):

- Verify that IGMP traffic is allowed.
- For example, issue the following CLI commands:
(config) # ip filter chain INPUT rule append tail target ACCEPT dup-delete protocol igmp
(config) # ipv6 filter chain INPUT rule append tail target ACCEPT dup-delete protocol igmpv6
- Verify that mDNS traffic is allowed.

If IGMP snooping is disabled, you do not need to allow IGMP traffic. However, you must allow UDP multicast traffic that targets 224.0.0.251. For example, issue the following CLI command:

```
(config) # ip filter chain INPUT rule append tail target ACCEPT dup-delete dest-addr 224.0.0.251 /32
```

where:

dest-addr specifies the multicast group

Enable an IGMP Querier

If IGMP snooping is enabled:

- Check if there is an IGMP querier on the cluster network. The querier periodically sends queries that trigger the nodes in the cluster to send IGMP membership reports. For example, use a sniffer tool to verify if there is an IGMP querier on the network, such as Wireshark.

- IGMP snooping and IGMP snooping querier settings vary by networking switch. Refer to the respective documentation for how to configure them on your device.

When IGMP traffic is allowed and an IGMP querier is enabled in the network, the switches in the network will be refreshed through the IGMP membership reports.

Cluster Safe and Limited Modes

Starting in software version 4.7, safe and limited modes are introduced to safeguard critical provisioning errors for both standalone nodes and nodes in a cluster.

During provisioning operations such as configuring a map, in rare scenarios there can be unrecoverable system errors that can potentially put the cluster, clustered nodes, or standalone nodes into unsafe or unstable states. Once in such a state, additional operations or configuration changes can cause the node to crash, the cluster to deform, or data traffic to be impacted. For example, due to a node attempting to rejoin a cluster, a chassis can end up in a reboot loop. In previous software versions, there was no way to prevent entering the loop.

These modes provide notification, stop further operations from being performed, and give you time to troubleshoot and plan the recovery of the cluster, the clustered node, or the standalone node.

Two modes are supported. The first is called safe mode and is triggered when the node detects unrecoverable errors, but the existing flow maps are not impacted. The second is called limited mode and is triggered when the node detects continuous system reboots. In this mode, the node will become standalone and only basic configuration will be allowed.

Safe Mode

A node enters safe mode when there are unrecoverable errors. Any node in a cluster can enter this mode. The purpose of this mode is to detect system configuration failures early and avoid future failures, such as system crashes.

Examples of unrecoverable errors are when there are inconsistencies between the system and the running configuration or when the cluster configuration did not merge properly with the existing configuration.

As part of merge error recovery, nodes joining a cluster are automatically restarted so the merge error can be fixed. If the restart cannot correct the merge error, the node will enter safe mode.

Another example is that a TA Series node could enter safe mode when unlicensed cluster ports are used in an offline configured map. (It is recommended to use only licensed ports in map configurations.)

A node will automatically enter safe mode.

To recover from safe mode, reload the node. If safe mode persists, contact Gigamon Technical Support.

Limited Mode

A node automatically enters limited mode when it detects repeated system crashes.

Limited mode is triggered when there are three (3) failures/system crashes within 15 minutes. In limited mode, the cluster configuration is ignored. No cluster configuration or GigaVUE-OS configuration is accepted when the node is in limited mode.

When limited mode has been detected, collect information and report it to Gigamon Technical Support.

Support for Cluster Types

The GigaVUE-FM workflow supports only out-of-band clusters; not inband clusters. To create and manage an inband cluster, refer to the *GigaVUE-OS-CLI Reference Guide*.

Create Clusters

GigaVUE-FM 5.3 supports workflow-based configurations for forming clusters:

- Refer to [Regular Cluster Formation Workflow](#) for instructions on how to use the regular cluster formation workflow.
- Refer to [Leaf-Spine Cluster Formation Workflow](#) for how to use the leaf-spine cluster workflow

Regular Cluster Formation Workflow

Gigamon's Cluster formation can be done for any number of devices with different combinations of devices.

GigaVUE-FM 5.3 supports workflow-based configurations for forming a cluster. This workflow walks through the required steps to form a complete cluster for a regular cluster.

NOTE: Refer to [Leaf-Spine Cluster Formation Workflow](#) for how to use the Leaf-Spine Cluster workflow

Deployment Checklist

Before forming a Cluster, it is strongly that you familiarize with the relevant documentation and review the deployment checklist to prepare for deployment.

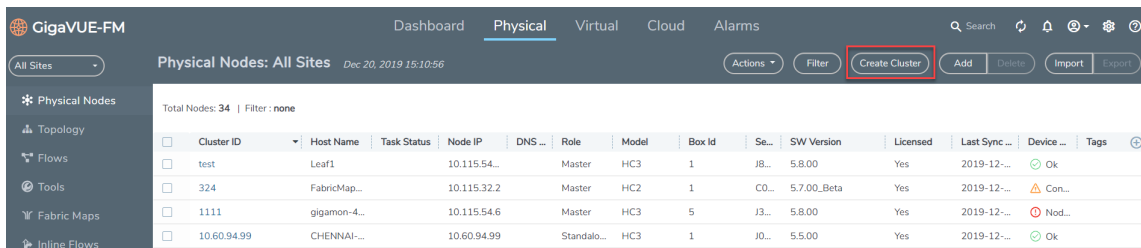
Pre-deployment checklist

- Gigamon Fabric Management must be upgraded to GigaVUE-FM 5.3.00 or later
- Gigamon device must be upgraded to GigaVUE-OS 5.2.00 or later
- Advanced Features License must be installed in TA devices
- Physical connection must be established to create stack links
- Devices must have GDP enabled and be physically connected to create links among devices from GigaVUE-FM.

Create Regular Cluster Formation

To create a cluster:

1. Navigate to **Physical > Physical Nodes**.
2. Click **Create Cluster**.



Cluster ID	Host Name	Task Status	Node IP	DNS ...	Role	Model	Box Id	Se...	SW Version	Licensed	Last Sync ...	Device ...	Tags
test	Leaf1		10.115.54...		Master	HC3	1	J8...	5.8.00	Yes	2019-12-...	Ok	
324	FabricMap...		10.115.32.2		Master	HC2	1	CO...	5.7.00_Beta	Yes	2019-12-...	Con...	
1111	gigamon-4...		10.115.54.6		Master	HC3	5	J3...	5.8.00	Yes	2019-12-...	Nod...	
10.60.94.99	CHENNAI...		10.60.94.99		Standalo...	HC3	1	J0...	5.5.00	Yes	2019-12-...	Ok	

Figure 64: Create Cluster

Select Cluster Type

3. The Create a Cluster screen opens with two options:
 - Create a Cluster
 - Create a Leaf Spine Cluster
4. Hover over the Create a Cluster option and click **Let's Begin** to start the wizard.

Select Devices

The wizard guides you through the cluster set-up. The first step is to select the devices in your cluster.

5. The Select Devices page displays a list of standalone devices with filter options:
 - *Software*: Filter the nodes based on the software version for which the cluster will be formed.
 - *Model*: Filter the nodes based on a Gigamon model.

- **HostName:** Enter the HostName of the Gigamon Nodes to specify a device.

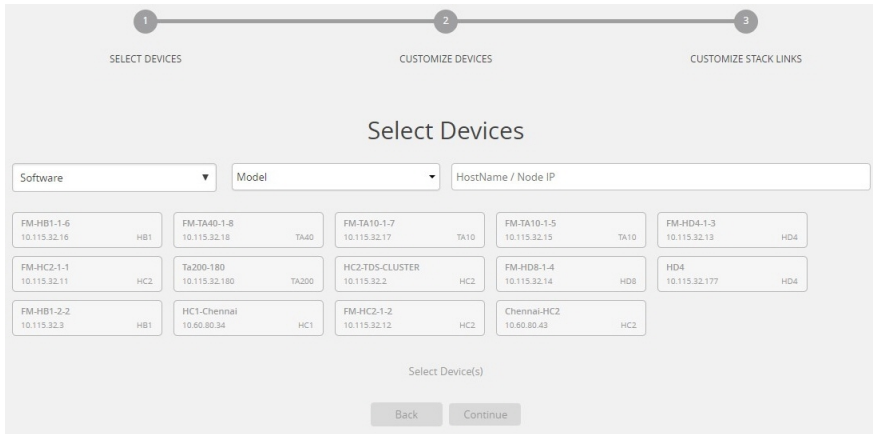


Figure 65: Select the required devices to form a cluster

6. Select the nodes to include in this cluster and click **Continue**.

Click a device to select it; click it again to deselect it. Selected devices are highlighted.

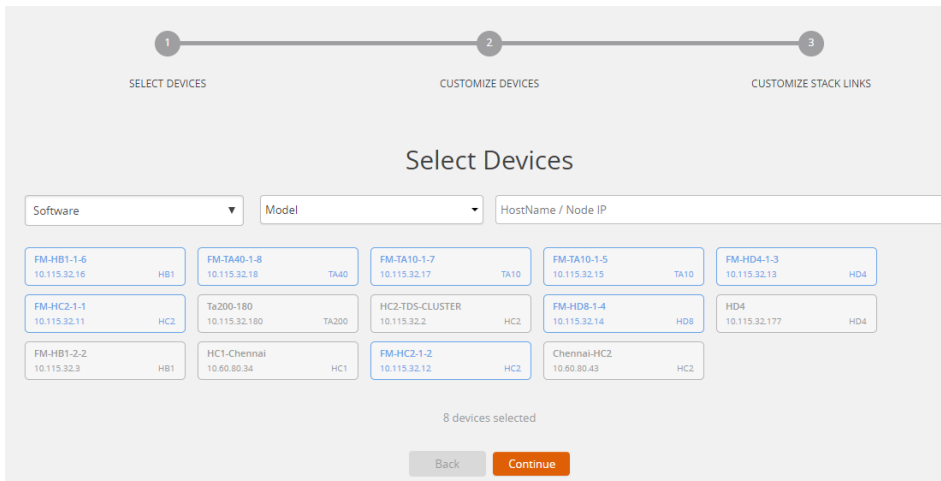


Figure 66: Selected devices will be highlighted

Customize Devices

Use the Cluster Configuration window to customize your devices.

7. Enter a valid **Cluster ID** and **VIP** and select the master node in the **Seed Node** list.

NOTE: The master cluster preferences in GigaVUE-FM determines which of the nodes will be the default the seed node. TA devices cannot be a master node.

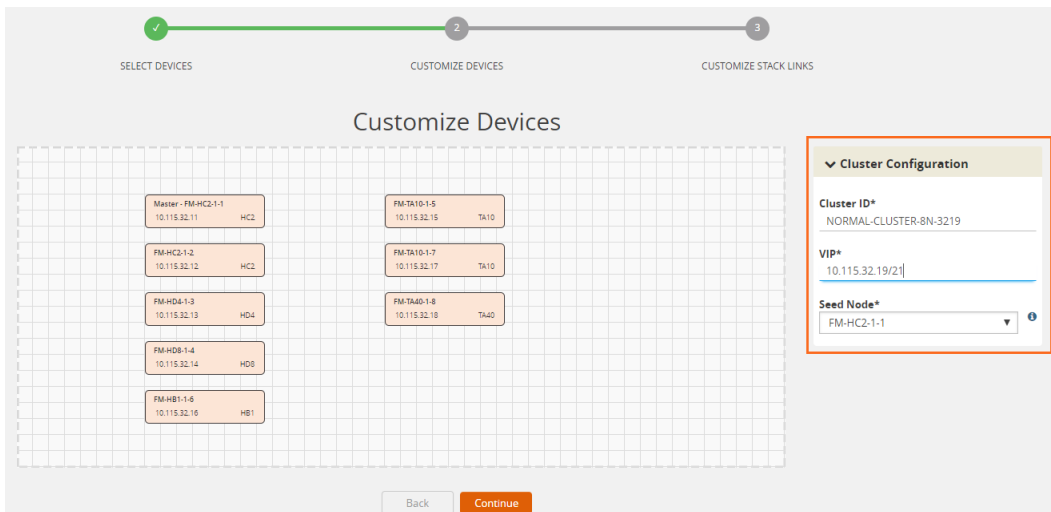


Figure 67: Fill up the cluster configuration details

- After completing the Cluster Configuration details, click **Continue**.

NOTE: Use the **Back** button to return to the Select Devices page to revise the selection of devices for this cluster.

Customize Stack Links

Finally, customize the stack links to define how the nodes should be connected.

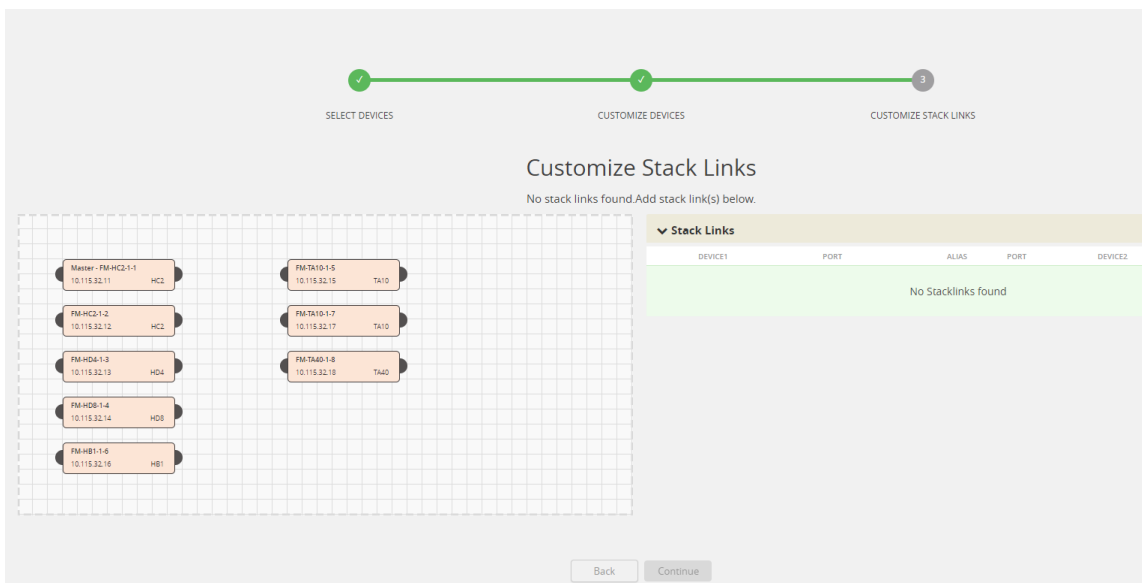


Figure 68: Create stack links by manually connecting the devices.

- Connect any two devices to create a stack links between those two devices.

Click the tip of the node and drag your cursor to the second node tip to create a link. After you create the link, a dotted line will illustrate the connection.

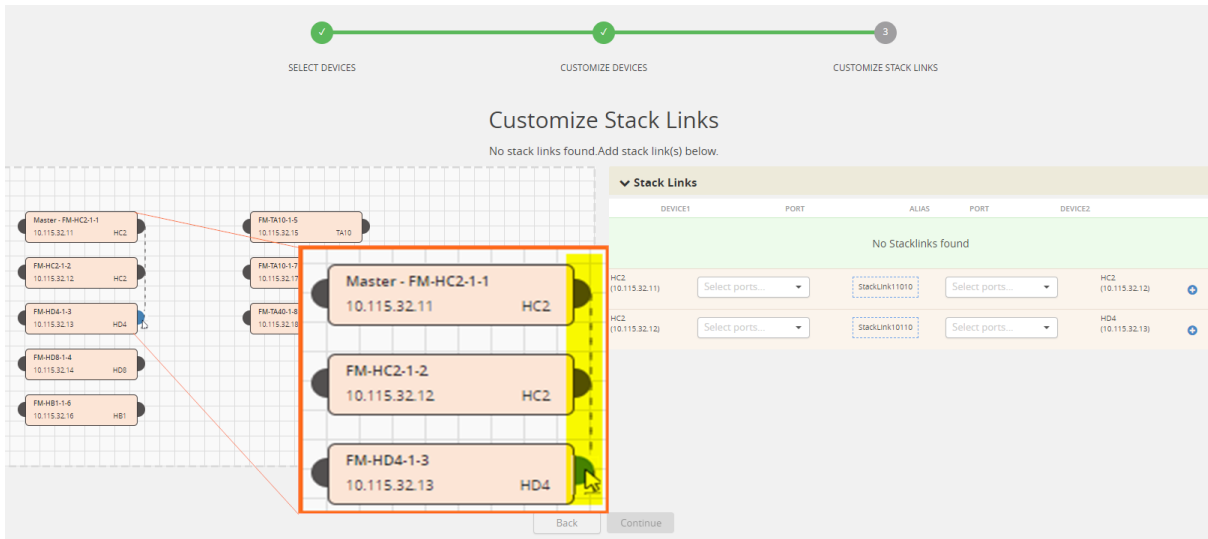


Figure 69: Create links between any devices

10. Configure the formed links in the **Stack Links** table as follows:

- Select ports in each device that are compatible, for example: x-x ports ,x-q ports, q-c ports, x-c ports.
- Select two or more ports in each device to create a stack GigaStream.
- After selecting the ports, save the stack link by clicking the **Save** button enabled in the right of stack link table.

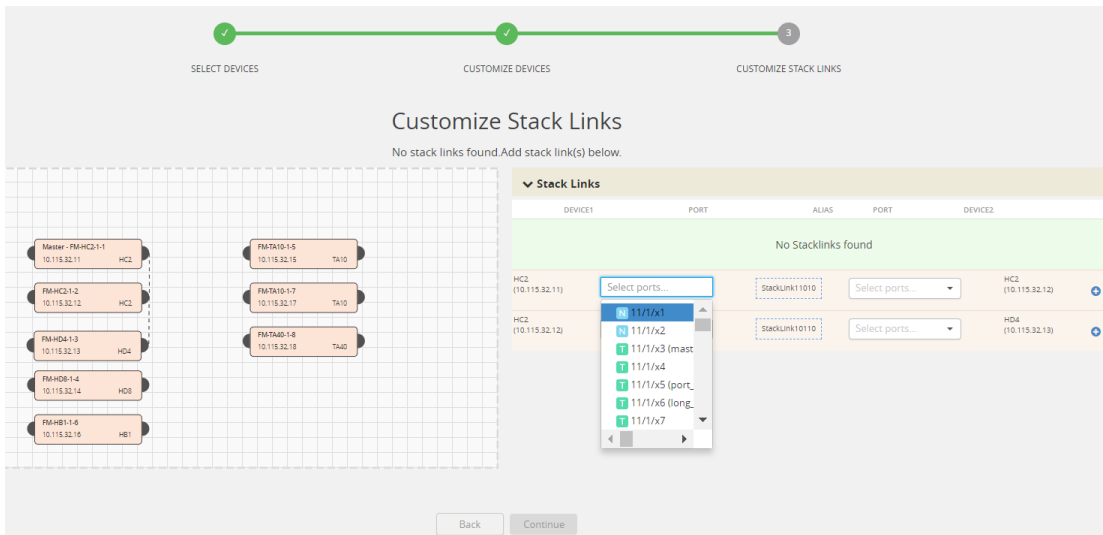


Figure 70: Select ports in each device

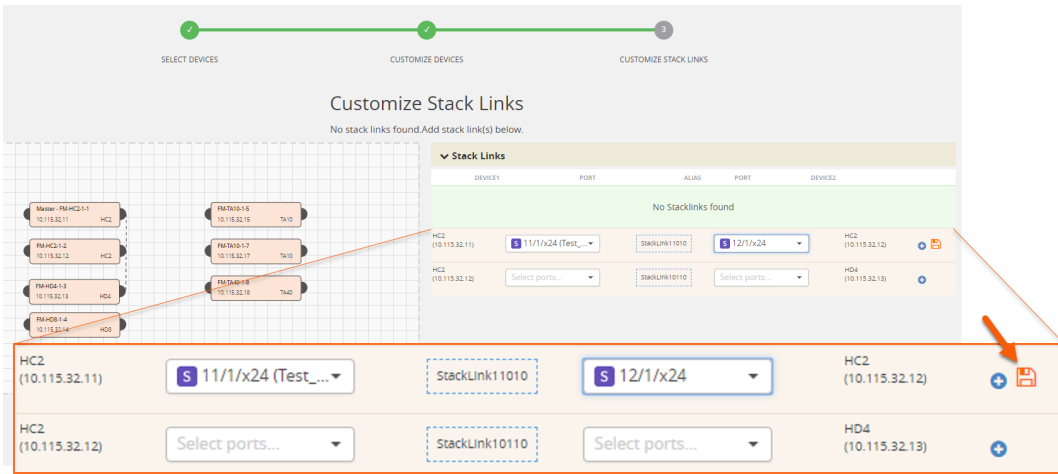


Figure 71: Save button will be enabled after selecting ports

The alias for each stack link and GigaStream is auto generated by GigaVUE-FM. This alias can be edited as needed.

- After the required Stack Links and GigaStreams are created and saved, click **Continue** to start the cluster creation process.

The Creating Cluster page appears as the cluster is being created.

The Create Cluster progress window in the lower right corner of the page shows the status of every node as it joins the cluster. It takes a few minutes for the cluster to form. The cluster creation process involves the following steps:

- Cluster[clusterName] Creation Successful followed by Seed device
- Verifying Nodes[Will display HostName of all devices]
- Adding Node[HostName] to cluster [clusterName]
- Node[HostName] successfully joined to the cluster.
- Configuring cards for cluster[clusterName]
- Rediscovering cluster[clusterName]
- Configuring ports for cluster[clusterName].
- Configuring ports will display the status of each stack link and GigaStream whether the creation is successful or not.

NOTE: Refer to [Check Cluster Status](#) for Events.

When the cluster formation process is complete the notification window will display a, "Create Cluster Completed," message.

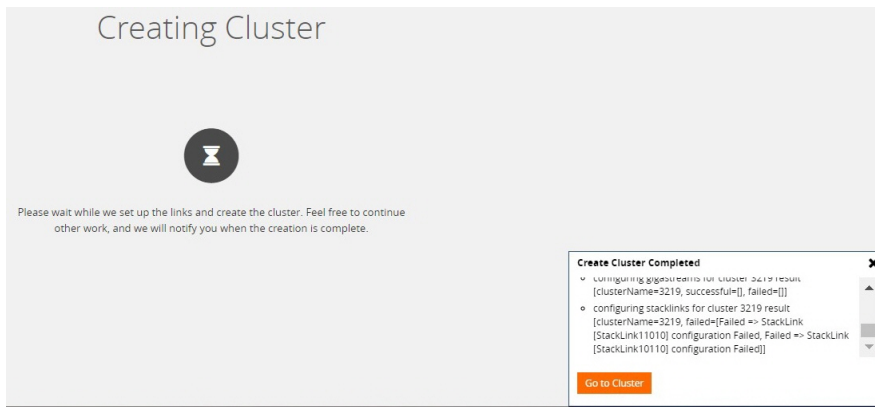


Figure 72: After cluster creation

- Click **Go to Cluster** to view the cluster overview.

Edit Cluster

The Edit Cluster action supports the following types of changes:

- Master preferences can be changed for each device.
- Multiple devices can be added to the existing cluster in a single update operation.
- Stack links can be created only from a new device that is being added.
- Stack link alias and GigaStream alias can be edited for newly created links.
- Nodes can be removed from an existing cluster, one at a time.

The following options are not supported by the Edit Cluster action:

- There is no option to remove existing stack links through the cluster wizard.
- There is no option to create links in existing devices.
- Addition and deletion of devices in a single update operation is not supported and is not recommended. If you attempt to add and delete devices in a single update operation, you may get unexpected results.
- There is no option to edit the existing stack link alias and GigaStream alias.
- If you rename a cluster using the GigaVUE-OS CLI, the rename does not reflect in the GigaVUE-FM. It is recommended that you use GigaVUE-FM to rename or delete clusters.

Prerequisites:

You must clear all configurations on a node before adding it to a cluster.

Edit options:

- [Add Nodes to a Cluster](#)
- [Remove Nodes from a Cluster](#)

- Edit Cluster Parameters

Inband Cluster Management

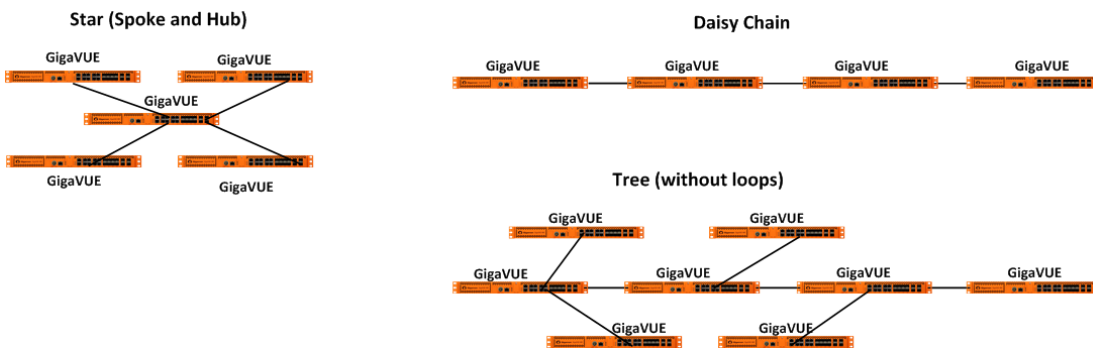
Inband Cluster Management simplifies traditional network management and maintenance by creating a virtual device to manage multiple physical nodes. This simplified approach makes it possible to oversee large networks by defining policies that span across multiple devices. The Inband Cluster Management feature is designed to reduce operational cost and extend coverage by eliminating a dedicated management network.

Inband Cluster Management is supported on all GigaVUE-OS nodes.

Inband Cluster Management Topologies

The benefits of Inband Cluster Management are to eliminate the Layer-2 Ethernet network and create a virtual management network through the data path where the data traffic is flowing.

Inband Cluster Management supports multiple topologies that include:



NOTE: Subsets or aggregations of these topologies may be created; however, it is important not to create a loop within these specified topologies.

Loops are typically created in the following scenarios:

- **Two Node Loops** occur between two nodes in a cluster forming two or more stack links and the stack links are not contained in one GigaStream.
- **Multi-Node Loops** occur when multiple nodes form a cluster whereby a link connects between node A and node B, another link connects between node B and node C, and yet another link connects between node C and node A.

Inband Cluster Management Stack Ports

A common Inband Cluster Management topology is configured between the Layer 2 device's Ethernet management port to a GigaVUE-OS node using a stack port configuration.

Two or more GigaVUE-OS nodes may be directly connected in a one-to-many relationship between physical connections. GigaVUE-OS nodes may also be indirectly connected if there is a path of stack ports between the nodes.

Inband Cluster Management Stack Ports Example

Figure 73: Inband Cluster Management Stack Port Configuration on GigaVUE-HB1 visually depicts how Inband Cluster Management uses the grouping of stack ports to connect between GigaVUE-HB1 nodes.

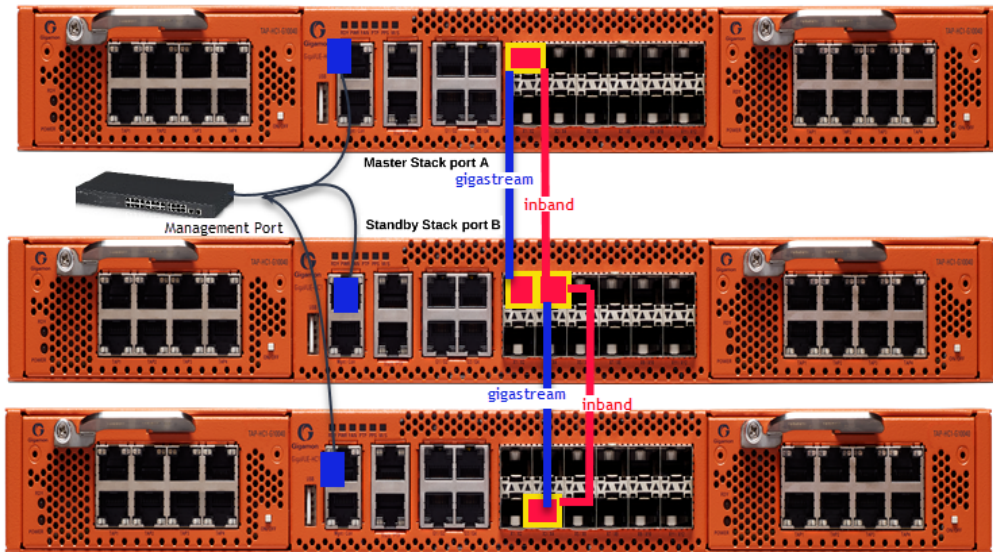
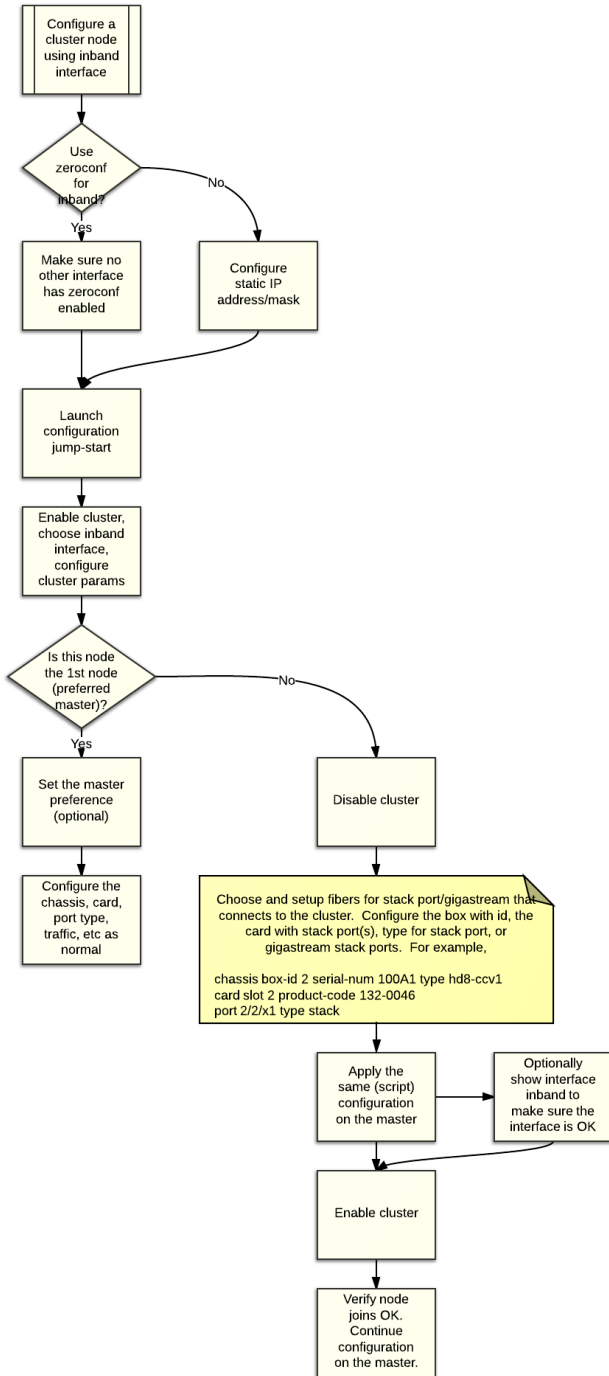


Figure 73: Inband Cluster Management Stack Port Configuration on GigaVUE-HB1

NOTE: Ensure that there is a physical connection between the stack ports of the two nodes that are being added to the Inband cluster.

Inband Cluster Management Configuration Flow Chart



Inband Cluster Management Configuration

An interface called "Inband" has been created upon boot-up to ensure backward compatibility with an existing clustered infrastructure. This interface has similar properties and characteristics of a typical Ethernet interface such as Eth0.

NOTE: Ensure that there is a physical connection between the stack ports of the two nodes that are being added to the Inband cluster.

Enable Cluster Management for GigaVUE TA Series Nodes

To enable clustering, GigaVUE TA Series nodes require an Advanced Features License. This license can be obtained by contacting Gigamon Sales team. In order to obtain the license for a Gigamon node, have the node serial number available. All licenses are tied to the serial number and cannot be moved.

For licensing the GigaVUE-OS on a white box, users can access the GigaVUE-OS licensing portal and obtain the license key online. In order to generate the license, the following are required: the serial number of the white box, digital footprint, and Gigamon Installation Key (GIK).

Add Nodes to a Cluster

You can manage an existing cluster through GigaVUE-FM by adding nodes to it. The nodes must be standalone nodes that are currently managed by GigaVUE-FM.

When a node joins an existing cluster, all of its existing traffic configuration, including maps, will be replaced by the configuration of the master node.

The following is an example of adding nodes to an existing cluster using GigaVUE-FM.

1. Navigate to **Physical > Physical Nodes**.
2. Select a cluster and choose **Actions > Edit Cluster**. The Edit Cluster - Canvas appears showing the existing stack link configuration details in the cluster wizard. Standalone devices appear in the Devices pane.

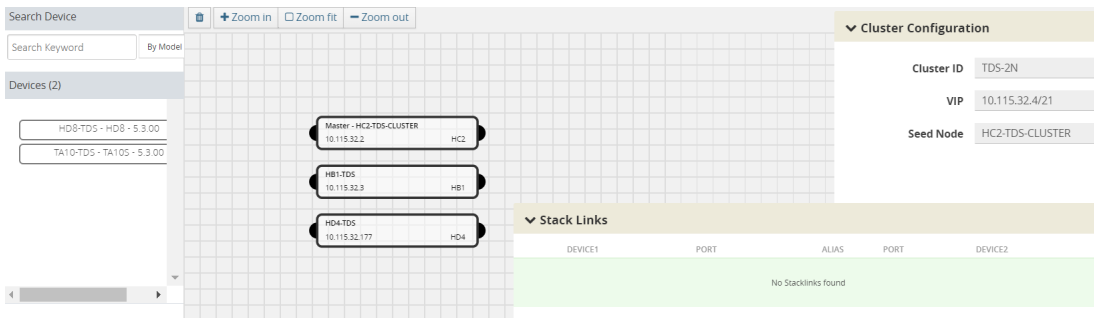


Figure 74: Edit cluster page

3. Drag the required devices from the Devices pane into the Edit Cluster canvas under the leaf or spine container.

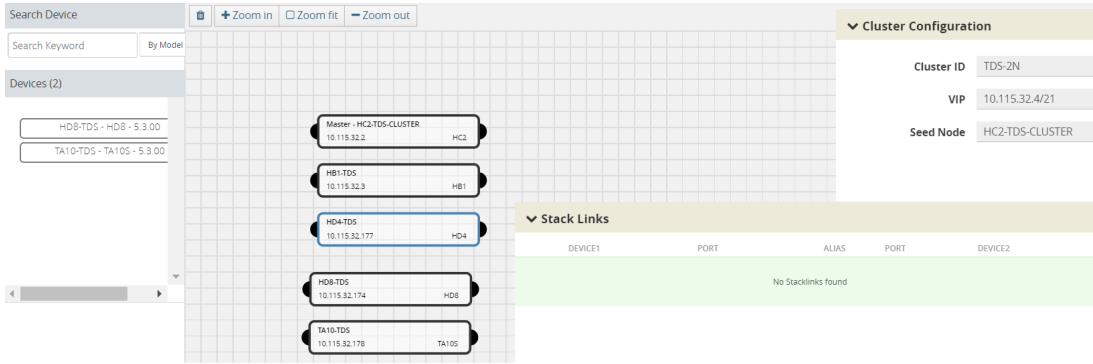


Figure 75: Drag the devices from devices column.

4. Connect the newly added devices to other devices to create stack links.

Click the tip of the node and drag your cursor to the second node tip to create a link. After you create the link, a dotted line will illustrate the connection

NOTE: No new link is created for existing devices; they need to be added manually.

5. Configure the stack link details in the stack link table and click **Save**.
6. Click **Update** to update the configuration.
A Confirmation window appears advising that all traffic configurations will be erased on newly added or removed nodes.
7. Click **OK** to continue.
8. The Manage Cluster update notification window appears showing the status of each update activity on the nodes, cards, GigaStreams and stack links.

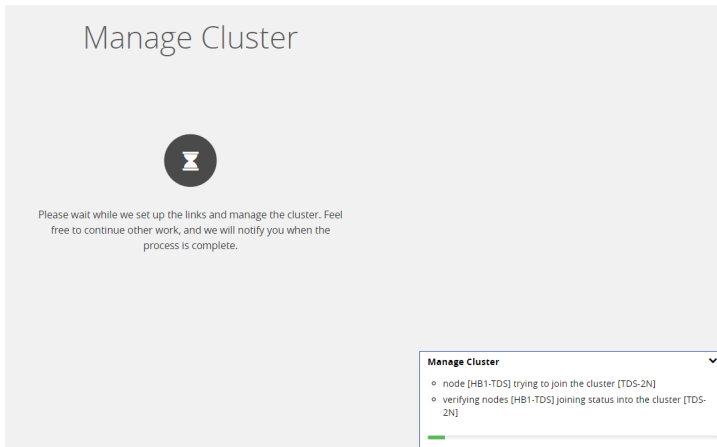


Figure 76: Notification pop up after update operation

9. After the cluster update operation completes, a “Manage Cluster Completed” message appears.

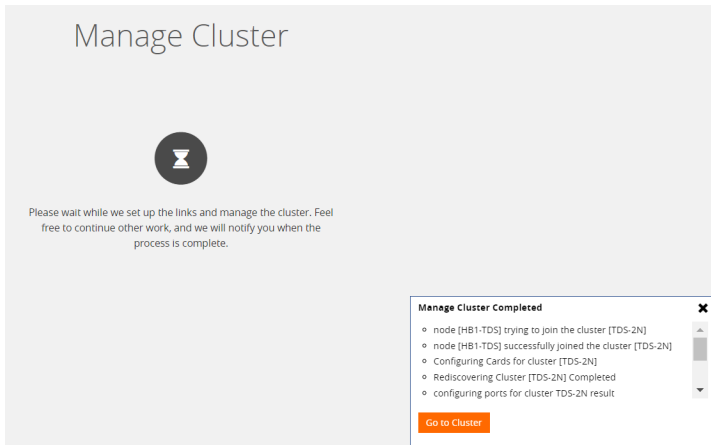


Figure 77: Cluster completion event

10. Click **Go to Cluster** to view the updated cluster overview

Remove Nodes from a Cluster

You can manage an existing cluster through GigaVUE-FM by removing nodes from it. After a node is deleted from a cluster, it will become a standalone node. FM will continue to manage it.

For nodes leaving a cluster, the username and password of the **admin** account on the cluster will be used for managing the node after it has been removed from the cluster.

To remove nodes of an existing cluster using GigaVUE-FM:

1. Navigate to **Physical > Physical Nodes**.
2. Select a cluster and choose **Actions > Edit Cluster**.

The Edit Cluster - Canvas appears showing the existing stack link configuration details in the cluster wizard. Standalone devices appear in the Devices pane.

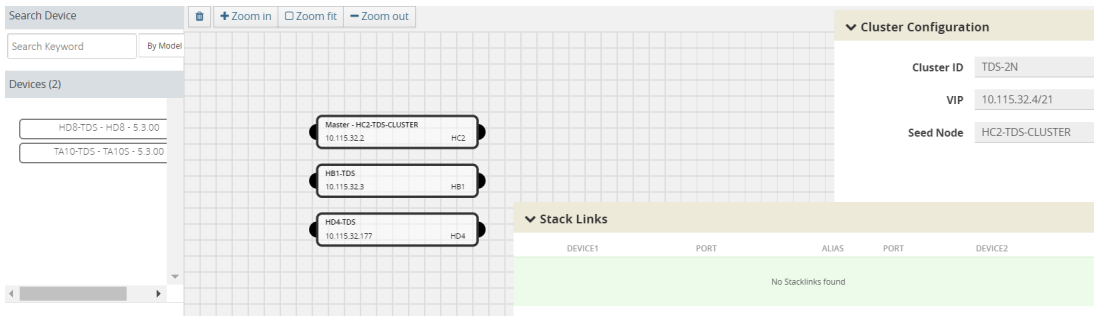
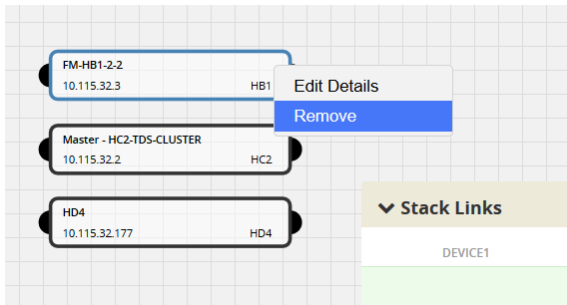


Figure 78: Edit cluster page

NOTE: Only one device can be deleted from canvas per operation. It can be any device from the cluster.

3. Right-click the device to be removed from the canvas and click **Remove**.



Right click to remove

4. The removed device is deleted from the canvas.
5. Click **Update** to update the configuration.

A Confirmation window appears advising that all traffic configurations will be erased on newly added or removed nodes.

6. Click **Ok** to continue.
7. The Manage Cluster update notification window appears showing the status of each update activity on the nodes, cards, GigaStreams and stack links.

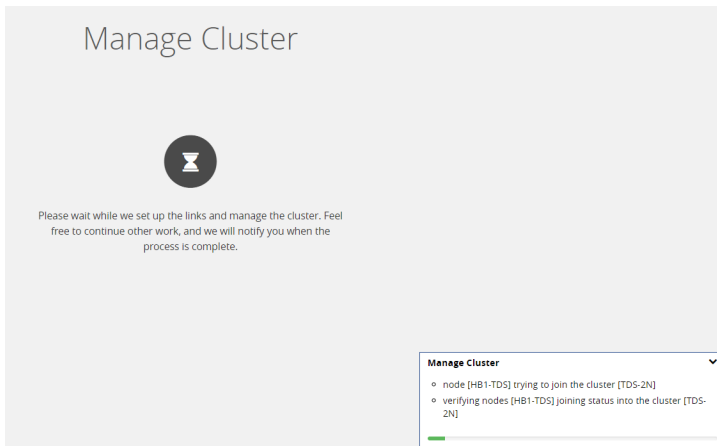


Figure 79: Notification pop up after update operation

8. After the cluster update operation completes, a “Manage Cluster Completed” message appears.
9. Click **Go to Cluster** to view the updated cluster overview.

Edit Cluster Parameters

When editing a cluster node, you can only edit the cluster master preference. You can only change the cluster master preference on one node at a time.

For the master preference, higher values are more likely to claim the Master and Standby roles; lower values are less likely.

To edit master preferences:

1. To set the master preference for devices, right-click the required device and click the **Edit Details** options button.

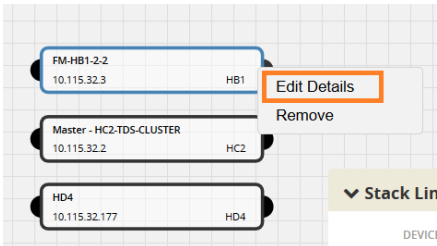


Figure 80: Right click to edit the details

2. The Device configuration quick view should appear on the right. Edit the Master Preference in the text box.
3. Click **OK**.

NOTE: Most of the fields are read-only. You can change the cluster master preference, as desired. Use preference settings from 10 to 100 for master, standby, and normal roles. Use preference settings from 1 to 9 for normal nodes that are excluded from taking the master or standby role. GigaVUE TA Series nodes always have a preference of 1.

4. After saving your changes to the nodes, click **Update** to apply the changes to the cluster.
A Confirmation window appears advising that all traffic configurations will be erased on newly added or removed nodes.
5. Click **Ok** to continue.
6. The Manage Cluster update notification window appears showing the status of each update activity on the nodes, cards, GigaStreams and stack links.
7. After the cluster update operation completes, a "Manage Cluster Completed" message appears.

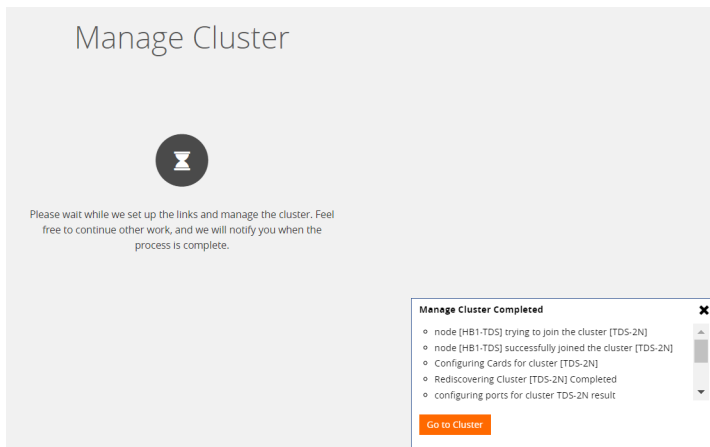


Figure 81: Cluster completion event

- Click **Go to Cluster** to view the updated cluster overview

Check Cluster Status

When a cluster is being created, you can check the status through cluster management events or audit log entries. Refer to the following sections:

- [Cluster Management Events](#)
- [Audit Logs](#)

Cluster Management Events

On the **Events** page, the following event types indicate the progress of the cluster as it is being formed:

- ClusterCreationStarted
- ClusterCreationCompleted
- ClusterCreationFailed

The following events indicate the status of nodes added to or removed from the cluster:

- NodeJoinedToCluster
- NodeFailedToJoinCluster
- NodeRemovedFromCluster
- NodeFailedToRemoveFromCluster

Figure 82: Node Joined to Cluster Event

Audit Logs

The following audit logs indicate the cluster management actions triggered by users from GigaVUE-FM:

- User <username> created cluster <clustername>
- User added device <device IP> to cluster <clustername>
- User removed device <device IP> from cluster <clustername>

Export Nodes and Clusters

To export the nodes and clusters:

1. Click **Physical** on the top navigation bar.
2. In the physical nodes page, select the nodes and clusters you want to export. You can select a single node or the nodes and clusters associated to the selected site.
3. Click **Export**. The physical nodes table is downloaded with a filename in the format nodes_<yyyymmddhhmmss>; for example, nodes_20161003172336.

Upgrade Software on a GigaVUE Node or a Cluster from GigaVUE-FM

This section describes the steps to upgrade the software on GigaVUE nodes and clusters. You can upgrade software by using an image that is located on an external image server, or you can use GigaVUE-FM as the image server for H Series and TA Series nodes. G Series nodes can only be upgraded with an external image server. Refer to [Upgrade G Series Node](#).

NOTE: When using GigaVUE-FM to upgrade software on the nodes, it is imperative that the minimum version on the node be at version 4.3.xx. If the software is not updated to version 4.3.xx, refer to the *GigaVUE-OS Upgrade Guide* and use either the CLI or GigaVUE-FM at the node level to upgrade the node to the latest revision.

Before upgrading a node or a cluster, it is important to note the following:

- GigaVUE-FM can upgrade up to 32 nodes at a time. For example, if you select a cluster with 8 nodes and 28 standalone nodes, GigaVUE-FM will fail to upgrade as the total number of nodes exceeds the limit.
- Check if the device that you want to upgrade has enough disk space. The disk space is computed based on the last synchronized time. A newly added node may sometimes show low disk space. Wait for approximately 5 minutes for the configuration sync to complete or rediscover the device and then check the disk space.
- When the upgrade process is complete, a post-upgrade sanity check is performed. Physical inventory snapshot of nodes, cards, ports, maps, and GigaSMART operations are captured and the numbers from before and after the upgrade are compared. Sometimes, these numbers do

not match immediately after the upgrade, as the device is still being configured. GigaVUE-FM checks every minute whether the nodes have joined the cluster. If the nodes joined do not increment in 30 minutes, then the sanity check will fail.

After the nodes join the cluster, GigaVUE-FM again checks every minute for other configuration objects to come up. If the configuration objects do not increment in 10 minutes, the sanity check will fail. When the sanity check fails, GigaVUE-FM provides an ability to view the configuration object that failed the sanity check.

- GigaVUE-FM v5.5.00 supports the installation of bootloader on GigaVUE H Series and GigaVUE TA Series nodes during the GigaVUE-OS image upgrade, but it does not automatically activate it.

NOTE: Depending on your configuration, you may need to enable physical bypass mode before performing the GigaVUE-OS image upgrade, and then restore it after the upgrade is complete.

During the GigaVUE-OS image upgrade, GigaVUE-FM v5.5.00 first upgrades the GigaVUE-OS image and then reboots the system. After the GigaVUE H Series or GigaVUE TA Series node has rebooted with the new GigaVUE-OS image, the bootloader installation will automatically initiate from GigaVUE-FM.

NOTE: The bootloader upgrade will apply only if there is a bootloader version change in the specific GigaVUE-OS software release. Refer to the *GigaVUE-OS Upgrade Guide* for the upgrade procedures and to check the bootloader version changes.

When the installation process completes, a message about the bootloader installation will appear in the GigaVUE-FM Task Log Details.

IMPORTANT: The newer bootloader version only goes into effect after an additional manual reboot. You must explicitly reload the GigaVUE H series or GigaVUE TA series device to update the bootloader version. This additional reboot will cause the optical-protection switches of the relevant Bypass Modules to change states multiple times.

RECOMMENDATION: To avoid this state-change behavior, enable the physical bypass before performing the GigaVUE-OS image upgrade. Refer to “*Configuring Inline Bypass Examples: Protected Inline Bypass Using Bypass Combo Modules*” section in the *GigaVUE-OS-CLI Reference Guide* for instructions on how to enable the physical bypass.

NOTE: Starting in GigaVUE-OS software version 4.7, the default password admin123A! for the admin user is no longer valid when logging in to the node. When upgrading from the CLI, the configuration jump-start script requires the user to change the default password for the admin user. However, if the node is upgraded to software version 4.7 or later using GigaVUE-FM, the admin password on the node is not changed.

No Default Password on admin User

Starting in GigaVUE-OS 4.7, the default password admin123A! for the admin user is no longer allowed. When upgrading a node to GigaVUE-OS 4.7 from GigaVUE-FM, if the target node uses the default password, you must change the password on the node upgraded to GigaVUE-OS 4.7. If a device is upgraded to GigaVUE-OS 4.7 from GigaVUE-FM, the next time you log into the device directly the following message is displayed the following message is displayed:

Admin account password must be changed via the CLI to a non-default value for security purposes.

Therefore, If you want to upgrading a node to GigaVUE-OS version 4.7 from GigaVUE-FM, and the target node is using the default password, it is recommended that you do the following to ensure a smooth transition:

1. Log in to the target node through H-VUE and change the password for the admin user. For details on setting the admin password through H-VUE, refer to the *GigaVUE-OS H-VUE User's Guide*.
2. Log in to GigaVUE-FM and set the credentials for the target node.
 - a. Select **System > Node Credentials**.
 - b. Click **Add**.
 - c. In the **Node IP** field, enter the node IP for the target node from step 1.
 - d. For **Username**, enter the admin's username.
 - e. In the **Password** and **Confirm Password** fields, enter the password for the node created in step 1.
 - f. Click **Save**.
3. Select **Authentication > RBAC**, and then do the following:
 - a. Select **Use node credentials entered during "Add Physical Node" for all node operations by all GigaVUE-FM users**.
 - b. Click **Save**.
4. Upgrade the node from GigaVUE-FM.

Upgrade from an External Image Server

This section provides the steps for upgrading the GigaVUE nodes and clusters from an image stored on an external server. The image can be transferred from the server to the node using either SCP or TFTP file protocols.

In a cluster configuration, to upgrade the software on the GigaVUE nodes, all the relevant images must be available to GigaVUE-FM. All nodes should be updated to the same version of software.

To upgrade a node or a cluster from an image stored on an external image server, do the following:

1. Upload the image to the external image server to make it available to GigaVUE-FM.

To obtain software images, register on the customer portal

(<https://gigamoncp.force.com/gigamoncp/>) and download the software. You must provide the serial number for each node you want to update.

To view the chassis serial number, login to H-VUE and select **Chassis** from the navigation pane. Click **List View**.

2. Click **Physical** on the top navigation bar.
3. On the Physical Nodes page, select one or more nodes or clusters to upgrade.
4. Select **Actions > Image Upgrade**.
5. Enter the following information:

Table 13: Image Upgrade

Menu	Description
Task Name	The name of the upgrade task.
Image Server	<p>The location from where the image can be uploaded.</p> <p>Do the following:</p> <ol style="list-style-type: none"> 1. For Image Server, choose External Server. 2. From the drop-down list, select the external image server added to GigaVUE-FM in Step 1.

Menu	Description
	<p>3. If the external image server is not available, click Add External Server. In the Add External Server quick view, enter the following:</p> <ol style="list-style-type: none"> In the Alias field, enter the name of the external server. In the Server Address field, enter the host IP address of the server. In the Type drop-down list, select SCP or TFTP as the file transfer protocol. If you select SCP, enter the username and password of the server in the Username and Password fields respectively. Click Add. <p>4. In the text box, enter the image path and the image name.</p> <div style="border: 1px solid #ccc; padding: 5px; margin-top: 10px;"> <p>NOTE: For a cluster, the images can reside on different paths. However, the image server and the protocol for file transfer should be the same for all the nodes.</p> </div>
Backup Config Before Upgrade	The check box to back up the configuration changes prior to performing the upgrade.
Reboot After Upgrade	The check box to reboot the server after performing the upgrade.
Time	<p>The time for performing the upgrade.</p> <p>There are two options:</p> <ul style="list-style-type: none"> Immediate—The upgrade is performed immediately. Scheduled—The upgrade is performed at a scheduled time. Select the date and time.

NOTE: If the disk space of a physical node or a node in a cluster is low, a message is displayed indicating that the node will not be upgraded due to low disk space.

6. Click **Upgrade**.

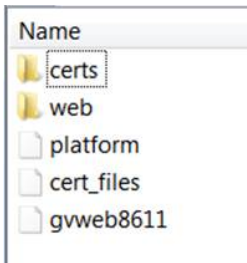
Upgrade G Series Node

When upgrading a G Series node from GigaVUE-FM, the Image Upgrade page includes a **File Type** field for specifying the type of file to use for the upgrade.

The possible selections for **File Type** are as follows:

- If you do not make any selection (that is, File Type field is left blank), the CLI image file is used to upgrade the node. The name of the file depends on the model that is being upgraded. The following are example filenames for each model:
 - GV212: gvd8611
 - GV216: gve8611
 - GV420: gvb8611
 - GV2404: gvc8611

- Select **Web** to upgrade the Web server on the node with the Web server image file. Web server image files starts with gwweb. This file is contained in a .tgz file (for example, gwweb8511.tgz) that you must expand on the image serve. After the file is expanded make sure that you have the files and directories shown in the following figure:



- Select **GigaSMART** to upgrade the GigaSMART card on the node with the GigaSMART image file. The GigaSMART image file name starts with gs. For example, gsc86_08_27.tgz. If you select this option, the **Target Slot** field displays (refer to [Upgrade from an External Image Server](#)). Use this field to specify the slot where the GigaSMART card is located.

Upgrade with GigaVUE-FM as the Image Server

This section provides the steps for upgrading the GigaVUE nodes and clusters when GigaVUE-FM is used as the file server instead of an external server.

NOTE: Only H Series and TA Series devices can be upgraded using GigaVUE-FM as the image server. To upgrade G Series devices with GigaVUE-FM, you must use an external server.

To upgrade a node or a cluster using internal image files, do the following:

1. Download the images from the Gigamon website and place them where they can be available for uploading to GigaVUE-FM.

To obtain software images, register on the customer portal (<https://gigamoncp.force.com/gigamoncp/>) and download the software. You must provide the serial number for each node you want to update.

To view the chassis serial number, login to GigaVUE-OS and select **Chassis** from the navigation pane. Click **List View**.

2. Click **Physical** on the top navigation bar.
3. On the Physical Nodes page, select one or more nodes or clusters to upgrade.
4. Select **Actions > Image Upgrade**. Under Selected Nodes, the disk space of all the nodes are displayed.

NOTE: If the disk space of the selected node or a node in the cluster is low, a message will be displayed indicating that the node will not be upgraded due to low disk space.

5. Enter the following information:

Table 14: Image Upgrade

Menu	Description
Task Name	The name of the upgrade task.
Image Server	<p>The location from where the image can be uploaded.</p> <p>Do the following:</p> <ol style="list-style-type: none"> 1. Choose Internal Server. 2. From the Version drop-down list, select the version to which you want to upgrade. 3. Click Add Image Files. 4. In the Add Image File quick view, click Choose Files and select the image files that you downloaded in Step 1. Click Add. <p>NOTE: If there is an image file missing in a cluster configuration, the Image file missing error is displayed.</p>
Update uboot	<p>The check box to update the binary bootloader or coreboot included with the active/boot image. Coreboot only applies to a GigaVUE-TA100, GigaVUE-TA100-CXP, GigaVUE-HC3, or GigaVUE-HC1 node.</p> <p>A reboot is required after the update.</p>
Backup Config Before Upgrade	The check box to back up the configuration changes prior to performing the upgrade.
Reboot After Upgrade	<p>The check box to reboot the server after performing the upgrade.</p> <p>If you do not select Reboot After Upgrade, you must reload the node manually.</p> <p>To reload the node manually, select the node on the Physical Nodes page and click Actions > Reboot.</p>
Time	<p>The time for performing the upgrade.</p> <p>There are two options:</p> <ul style="list-style-type: none"> • Immediate—The upgrade is performed immediately. • Scheduled—The upgrade is performed at a scheduled time. Select the date and time.

6. Click **Upgrade**.

NOTE: When the GigaVUE-FM IP address is changed through jump-start configuration, the GigaVUE-FM internal database and in-memory caches are not be updated. The Database continues to have the old GigaVUE-FM IP address, and attempting an image upgrade with the internal server option doesn't work. To fix this, you must restart the GigaVUE-FM.

Problems with SCP?

After upgrading GigaVUE-FM to a new release, under some circumstances you may find that a previously-managed H Series node no longer accepts SCP commands to backup or restore configuration files. This can happen when the SSH keys in use change, causing a mismatch between the keys stored on the H Series node and those presented by GigaVUE-FM. Use the following steps on the H Series node to remove the GigaVUE-FM server from the H Series node's list of addresses, resolving the issue:

1. Log in to the affected H Series node and switch to Configure mode.
2. Use the **ssh client user admin known-host?** command to discover the IP address for the GigaVUE-FM server. For example:

```
(config) # ssh client user admin known-host ? 10.150.100.23 10.150.100.77
```
3. The question mark (?) instructs the H Series node to list the known ssh clients. From the list of IP addresses returned by the CLI, identify the one belonging to GigaVUE-FM and remove it using the **remove** argument. For example, if 10.150.100.77 is the GigaVUE-FM server's IP address:

```
(config) # ssh client user admin known-host 10.150.100.77 remove
```

Return to GigaVUE-FM and attempt the configuration backup again.

Events

The Events page displays all the events that occur in the physical nodes or clusters associated to the selected site. An event is an incident that occur at a specific point in time. Examples of events include:

- Device status change
- Stack image install status
- Fan tray changed

Click **Physical** on the top navigation bar. On the Physical Nodes page, select All Sites or a specific site on the left navigation pane and click **Events**.

For information about the parameters for each event, refer to the “*Event Parameters*” section in the *GigaVUE-OS and GigaVUE-FM Administration Guide*. For filtering the events, refer to the “*Filter Events*” section in the *GigaVUE-OS and GigaVUE-FM Administration Guide*.

NOTE: The events can be purged or archived only from the Events page. For more information, refer to the “*Archive or Purge Event Records*” in the *GigaVUE-OS and GigaVUE-FM Administration Guide*.

Alarms

An Alarm is a response to one or more related events. If an event is considered of high severity, then GigaVUE-FM raises an alarm. Examples of alarms include:

- High or low port utilization
- High or low CPU utilization
- High exhaust temperature

The alarms broadly fall into the following categories: Critical, Major, Minor, or info.

Audit Logs

With Audit Logs, changes and activities that occurred in the physical nodes or clusters due to user actions can be easily tracked for auditing. Audit logs can be displayed for All Sites or a specific site. The logs can also be further filtered to view specific information.

For information about the parameters in the audit log page, refer to the “*Overview of Audit Logs*” section in the *GigaVUE-OS and GigaVUE-FM Administration Guide*. Filtering the audit logs allows you to display specific type of logs. For more information, refer to the “*Filtering Audit Logs*” section in the *GigaVUE-OS and GigaVUE-FM Administration Guide*.

Search for Specific Nodes Using Keywords

The filter option provides a way for the users to narrow down the display using certain keywords such as Standalone, Clusters, H Series and others. As you click on the Filter button, you will see the quick view window pop-up.

The Filter quick view provides you filter criteria for your search. These options are available in the drop down menu under Criteria. You can further narrow the options using the Model, Software Version #, Cluster ID, Host Name, DNS Name, or Node IP. You are not required to fill in all these options to narrow your search. As you select these options in the quick view, you will see the options narrowing in the main window.

To clear or revert the search, do any of the following:

- To clear a part of the search, use backspace to clear the search entry and re-type a new option.
- To clear all the search criteria, use the Clear button on the top of the quick view window.
- To revert to the main window with the new searches, click on the **X** of the quick view window.

To revert to all nodes visible, you can use the clear filter option on top of the main window or the clear option in the quick view window. When no filters are in place, this option will no longer be visible in the main window.

Search for Ports on a GigaVUE Node

When viewing a node from GigaVUE-FM, you can use Port List Filter feature to display only certain ports that match specified criteria, such as only those ports that are used in a map.

To use the port list filter:

1. Select a physical node from the **Physical Nodes** page and then select the node to view.
2. Go to **Ports > Ports > All Ports**.
3. To filter the ports, click **Filter**. The Filter quick view is displayed.
4. Specify the criteria of the ports you want to filter.

The criteria that you can use to filter the port list is as follows:

Criteria	Description
Box/Slot ID	Display only those ports that match the specified box and slot IDs.
Port Alias	Display port with the specified alias.
Port ID	Display ports with specified number in the port ID. For example, if you specify 3 the result will also display ports that include the number 3, 13, 23, 30, and so on.
Type	Display ports with the specified port type. Select one of the following: <ul style="list-style-type: none"> • Network • Tool • Inline Network • Inline Tool • GigaSMART • Hybrid

Criteria	Description
	<ul style="list-style-type: none"> Stack
Port Used in Map(s)	Display ports based on their usage in maps. The possible selections are: <ul style="list-style-type: none"> All — display all ports either unused or in use by maps. This is the default. In Use — display ports that are in use by any map. Unused — display ports that are not use by any maps.
Admin Status	Display ports based on their current admin status. The possible selections are: <ul style="list-style-type: none"> All — display ports with a status of Enabled or Disabled. This is the default. Enabled — display ports with admin enabled. Disabled — display ports with admin disabled.
Speed	Display ports with the selected port speed. The port speeds available depend on the node.
Transceiver Type	Display ports with the selected transceiver type. The transceivers available selection depend on the type of transceivers connected to the ports.

To remove the filter selections, click **Clear**.

After the filter is applied, the Ports page displays only the ports that correspond to the selected filters and shows the total number of ports that meet the criteria. To clear the filters, select **Clear Filter**. [Figure 83: Filtered Ports List](#) shows the Port pages with two ports that correspond to the current filters: Network Type and Admin Status Enabled.

Total Filtered Ports : 2 Clear Filter					
<input type="checkbox"/>	Port Id	Alias	Type	Speed	Admin Enabled
<input type="checkbox"/>	10/1/x1		N	10G	✓
<input type="checkbox"/>	10/1/g1	1G	N	1G	✓

Figure 83: Filtered Ports List

Overview Page

The **Overview** page displays general information on the specific H Series node, which includes System, Ports, Maps, and Traffic information.

Systems Information

Systems information is displayed on the System widgets.

The Systems widget displays general information about the specific device that you selected from the drop-down list at the top of the widget. If the system is a cluster, you can select a device in the cluster to display on the widget. This widget gives you a quick status if any issues are present in any of the device's components through color indicators; green (running), amber (warning), or red (alert).

NOTE: Ensure that all the nodes and clusters have a Box ID defined. If the Box ID is missing, the Systems widget may not display any information relating to the node.

NOTE: Red alert appears for cards not present.

Field	Description
Host Name	The host name of the box.
Hardware	The hardware type, (for example, GigaVUE-TA1).
Software	The version of the software running on the device.
Memory	Shows the amount of used and free memory.
Load Average	The average load on the system over the last 1 minute, 5 minutes, and 15 minutes.
Cards	Displays all slots for the specific hardware type including its slot number and the type of card it contains or not. Note: When you hover over the card slot, the temperature is displayed.
Fan Trays	Indicates that the Fans are On or Off.
Power Supply	Indicates that the power supply is On or Absent. NOTE: When one or more power supply units are down, red alert is displayed.

Failure to Authenticate

To view a physical node in the Dashboard System pane, your login credentials must have the appropriate permissions. Otherwise, GigaVUE-FM shows an error message.

There are two possibilities that caused a user authentication error:

- The login user credential for GigaVUE-FM is not **“admin”**.
- The password associated with the login user name for GigaVUE-FM is different for the physical device.

NOTE: When a “non-admin” user goes to Physical Nodes page, they are able to view displayed physical nodes with the status as Green, Amber or Red, this is because the physical node information is captured using the default “admin” user role.

Ports Information

The Overview page displays widgets that provide port information for the number of ports down, the number of ports with packet drops, and the number of over utilized receiving (Rx) ports and transmitting (Tx) ports. The ports widgets default to displaying a counter. Clicking on the icon in the upper right-hand corner displays the information as a table. The Ports with Packet drops and Over-Utilized Ports widgets are similar.

Traffic

The Traffic widget shows most-utilized ports and ordered by traffic count. Each displayed port is labeled with its location, whether it is a transmitting or receiving port, and its percentage of utilization.

NOTE: The Traffic pane is view-only. It reflects traffic activity with port ID at the time of discovery and does not immediately refresh.

Workflows

The Workflows page provides wizards for creating maps. These wizard step you through the work flow to make sure you configure all of the components necessary for configuring out-of-band and inline maps for traffic flow monitoring. The workflows keep track of each step so that you can stop and then return to where you left off in the workflow. However, you can only work on one workflow at a time.

Overview of Workflows

[Table 15: Map Types and Map Wizards](#) describes the maps that you can create with the wizards.

Table 15: Map Types and Map Wizards

Map Type	Map Wizard	Description
Out-of-Band maps	Map with rules	Walks you through the steps to select source and destinations ports, then create a Regular By Rule map with those ports.
	Pass-all map	Walks you through the steps to select source and destinations ports, then create a Pass All map with those ports.
	Collector map	Walks you through the steps to select source and destinations ports, then create a Collector map with those ports.
Inline maps	Map with rules	Walks you through the steps to select the destination and source, then use them in an Inline By Rule map. If the Inline Networks or Inline Network Groups have not been created yet, you can create them from the wizard. The wizard selects Symmetric for Traffic Type.
	Pass-all map	Walks you through the steps to select the destination and source port, then use them in an Inline Pass All map. If the Inline Networks or Inline Network Groups have not been created yet, you can create them from the wizard. The wizard selects Symmetric for Traffic Type.
	Collector map	Walks you through the steps to select the destination and source ports, then use them in an Inline By Rule map. If the Inline Networks or Inline Network Groups have not been created yet, you can create them from the wizard. The wizard selects Symmetric for Traffic Type.
	Asymmetric Inline map	Walks you through the steps to select the destination and source ports, then use them in an Inline Pass All map. The source port must be an Inline Network port. The destination port must be an Inline Tool, an Inline Tool Group, or an Inline Serial Tool Group. If the Inline Networks or Inline Network Groups have not been created yet, you can create them from the wizard. The wizard selects Asymmetric for Traffic Type.
Basic out-of-band GigaSMART maps:	Map with GigaSMART Apps	Walks you through the steps to select a GigaSMART Group, GigaSMART operation, select the source and destination ports, and then create a Regular By Rule map. The wizard allows you to create the GigaSMART Group and GigaSMART operation if they do not already exist.
	First level map	Walks you through the steps to select or created the source port and select a or create a virtual port for the destination port, and then create a First Level By Rule map.
	Second level map	Walks you through the steps to select or created the virtual port for the source port and select a or create the port for the destination port, and then create a Second Level By Rule map.
Advanced out-of-band GigaSMART maps	Map with NetFlow	Walks you through the steps to select or create an IP interface; a NetFlow exporter, records, and monitor; a GigaSMART Group and Operation, source ports; and then created a Regular by Rule map.
	SSL-based map	Walks you through the steps to create or select a GigaSMART Group, configure SSL, create or select a GigaSMART Operation, and then create a Regular By Rule map.
	Map with ASF	Walks you through the steps to create or select a GigaSMART Group, virtual port, and GigaSMART Operation; configure GigaSMART Application Session Filter; and create the First and Second Level maps needed for implementing an ASF solution.

How to Use Workflows

To start a workflow, click on one of the links, such as **Map with Netflow**. When you click on the link, the Workflow page is displayed. The Workflow panel on the right shows the tasks in the workflow, indicating the current task.

While using workflows, you can only work on one workflow at a time. Also, you cannot roll back changes made to a node after canceling a workflow.

A task in the workflow allows you to select an item or create the item if one does not exist. For example, a GigaSMART Group needs to be selected if one does not exist. In this case, click **Create**. Clicking Create takes you to the GS Group configuration page. Configure the GigaSMART Group and click **Save**.

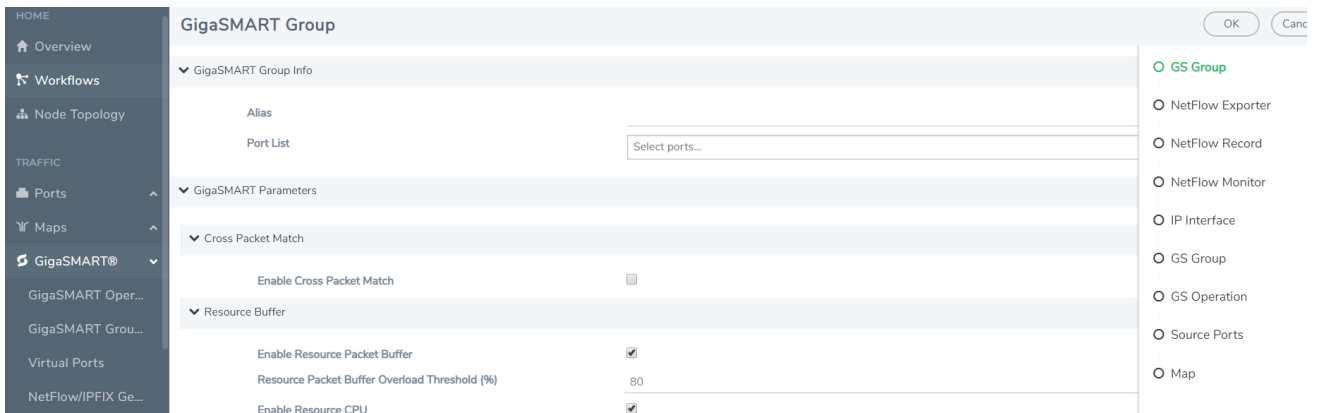


Figure 84: GS Group Configuration in Workflow

After saving the configuration, the Workflow moves to the next task and the Workflow panel indicates which tasks have been completed.

You can select a task in a different order than shown in the Workflow panel. For example, you can go to the NetFlow Monitor task. After completing the task, the Workflow returns you to the to the GS Group configuration page with the Monitor field completed.

Workflow allows you to leave the current workflow and return at anytime during a GigaVUE-FM session. The **In Progress** panel indicates the current workflow and the Workflow panel indicates the competed tasks. [Figure 85: Workflow in Progress](#) shows an example of workflow in progress. You can abandon a workflow by clicking the red x in the **In Progress** panel.

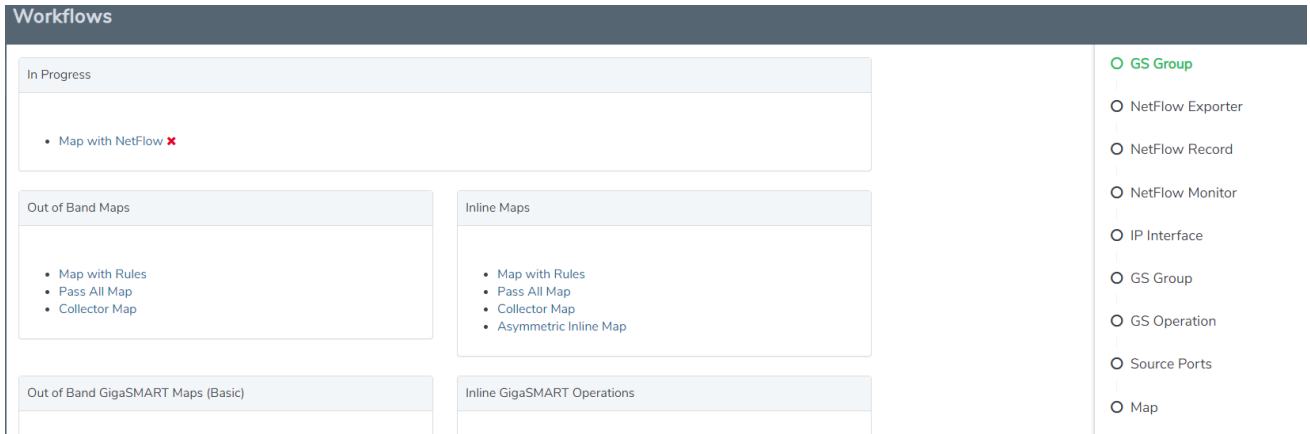


Figure 85: Workflow in Progress

When a workflow is completed, a page displays providing you with several choices for the next task. For example, when the Map with Rules workflow is completed, you can go to creating a collect map by clicking the **Create a Collector Map**, return to the Workflow page by clicking **To Work Flows**, or go to the Maps page by clicking **To Maps**.

Chassis Table View

When viewing the Chassis Table View managed from GigaVUE-FM, the Table View includes environment information about the chassis in addition to the other information available when using GigaVUE-HVUE on a device running Gigamon-OS 4.6 or later.

The Table View provides the following information about the chassis and its components:

Chassis Information	Description
Properties	Provides information about the chassis.
Cards	Describes the cards installed in each slot of the chassis, including its current status.
Environment	Provides temperature and voltage information about the chassis.
Power Supplies	Describes the power supplies installed in the chassis, including their current status.
Fan Trays	Describes the fan trays installed in the chassis, including their current status.
Fan RPM	Provides the current RMP of the each fan.

Live Graphing

When viewing ports on a node running GigaVUE-OS 4.6 or later from GigaVUE-FM, you can select to see the graph data display in real time by clicking **Live**. This changes the updating of the information in the graph from the default to every 10 seconds. You can also select the data to display on the graph by selecting an option from the Select Counter list. [Figure 86: Live Graphing and Data Counters Selected](#) shows an example, where Live is selected and the Data Rate Rx and Packets Rx counters are selected.

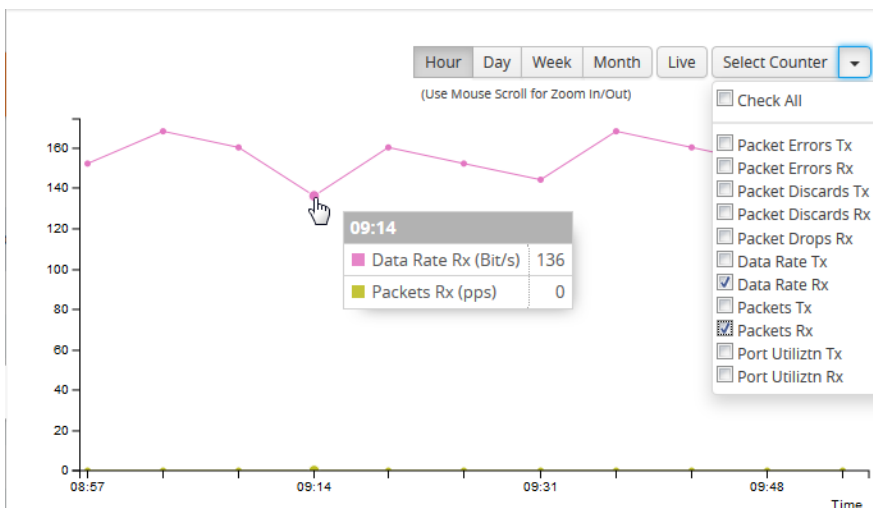


Figure 86: Live Graphing and Data Counters Selected

Safe and Limited Modes

Starting in GigaVUE-OS software version 4.7, safe and limited modes are introduced to the cluster environment and standalone nodes.

During clustering operations, in rare scenarios, there can be unrecoverable system errors that can potentially put the cluster or the clustered nodes into unsafe or unstable states. Once in such a state, additional operations or configuration changes can cause the node to crash, the cluster to deform, and the data traffic to be impacted. For example, due to a node attempting to rejoin a cluster, a chassis can end up in a reboot loop. In previous software versions, there was no way to prevent entering the loop.

These modes provide notification, stop further operations from being performed, and give you time to troubleshoot and plan the recovery of the cluster or of any node in the

cluster or standalone node.

Two modes are supported. The first is called safe mode and is triggered when the node detects unrecoverable errors, but the existing flow maps are not impacted. The second is called limited mode and is triggered when the node detects continuous system reboots. In this mode, the node will become standalone and only basic configuration will be allowed.

When a cluster is in safe mode, GigaVUE-FM displays a Safe Mode banner and message.

Safe Mode

A node enters safe mode when there are unrecoverable errors. Any node in a cluster can enter this mode.

Examples of unrecoverable errors are when there are inconsistencies between the system and the running configuration or when the cluster configuration did not merge properly with the existing configuration. A node will automatically enter safe mode.

As part of merge error recovery, nodes joining a cluster are automatically restarted so the merge error can be fixed.

When a node is in safe mode:

- The node displays a banner indicating it is in safe mode.
- An SNMP trap is sent to notify the user when the mode changes
- Traffic provisioning is not allowed on the affected node. Any other configuration remains as is.
- Configured traffic continues to be forwarded.
- If the standby node in the cluster is in safe mode, it can still become the master if the current master fails or switches over, but the database on the standby node may not be in sync, so it is not recommended to continue in that state. Instead, take immediate action to recover the node.
- In safe mode, the node does not process any incoming traffic configuration from the cluster master.

When a node is in safe mode and you try do any operations that are not allowed in safe mode, the UI displays the following message:

```
The system has restricted provisioning in safe mode. Contact Gigamon Support on how to troubleshoot and recover from safe mode.
```

Also, hovering over the status bubble of the nodes on the Physical Nodes page in GigaVUE-FM displays a message that the node is in Safe Mode.

To exit safe mode, reload the node.

Limited Mode

A node automatically enters limited mode when it detects repeated system crashes.

When a node is in limited mode:

- The node displays a banner indicating that it is in limited mode.
- An SNMP trap is sent to notify the user when the mode changes.
- Only basic system provisioning is allowed. Traffic provisioning is not allowed. Only commands that are related to image download, installation, next boot, and reboot are allowed.

Limited mode is triggered when there are three (3) failures/system crashes within 15 minutes. In limited mode, the cluster configuration is ignored. No cluster configuration or GigaVUE-OS configuration is accepted when the node is in limited mode.

When a node is in limited mode, a Limited Mode banner displays in GigaVUE-FM.

Enable SNMP Trap for Safe Mode and Limited Mode

Use the following steps to configure a notification that will be sent to all configured destinations when a node in the cluster changes from operational mode to safe mode or from operational mode to limited mode

The safe mode and limited mode capabilities are enabled through the SNMP trap event Operational Mode Change. To enable the trap on a node, do the following:

1. Click **Physical** on the top navigation bar. On the Physical Nodes page, select the node you want to configure.
2. Select **Settings > Global Settings > SNMP Traps**.
3. Click **Trap Settings**.
4. On the Edit SNMP Traps Settings page, select **Operational Mode Change**.
5. Click **Save**.

When the cluster master enters safe mode, the SNMP trap will be sent and the master will be identified as the local node in the trap.

When a node in a cluster enters safe mode, the SNMP trap will be sent and the node will be identified as the local node in the trap. In addition, a notification will be sent to the cluster master. The node that entered safe mode will be identified by its box ID in the notification to the master.

Log messages also provide information. The following is a sample log:

```
Jun 8 13:46:27 GC-TA10-N6 mgmtd[2400]: [mgmtd.INFO]: SAFE mode: Merge error detected !! Triggering SAFE mode ...
```

Collect Information for Technical Support

Collecting the following information can help Technical Support:

- sysdumps/debug dumps for all nodes in the cluster
- sysdumps for nodes that observed a crash entering safe or limited mode
- debug dumps for nodes that did not observe a crash
- gslogs for application information
- console logs
- CLI histories
- CLU, H-VUE, or FM screen captures
- SNMP captures

To contact technical support, refer to [Contacting Technical Support on page 1231](#).

Multi-Path Leaf and Spine

This chapter describes the leaf and spine architecture with multiple paths for achieving high availability in a cluster environment. Refer to the following sections for details:

- [Introduction to Multi-Path Leaf and Spine](#)
- [Configuration Overview](#)
- [Leaf-Spine Cluster Deployment](#)

NOTE: Refer to [Regular Cluster Formation Workflow](#) for how to use the Regular Cluster workflow.

Introduction to Multi-Path Leaf and Spine

The leaf and spine architecture is a two-layer architecture used for network aggregation. There are two kinds of nodes in this architecture, as follows:

- leaf nodes, which are edge nodes and can also have TAPs or tools attached to them
- spine nodes, which are the nodes to which the leaf nodes attach

With multiple paths between the nodes in a cluster, the leaf and spine architecture protects against failures, such as stack link or spine node failures. In the event of a failure, the traffic on one path fails over to the other path.

In this architecture, each leaf node connects to every spine node. This forms a mesh between the leaf and spine nodes. However, no leaf node directly connects to another leaf node and no spine node directly connects to another spine node. An example of a spine and leaf architecture is shown in [Figure 87: Leaf and Spine Architecture](#).

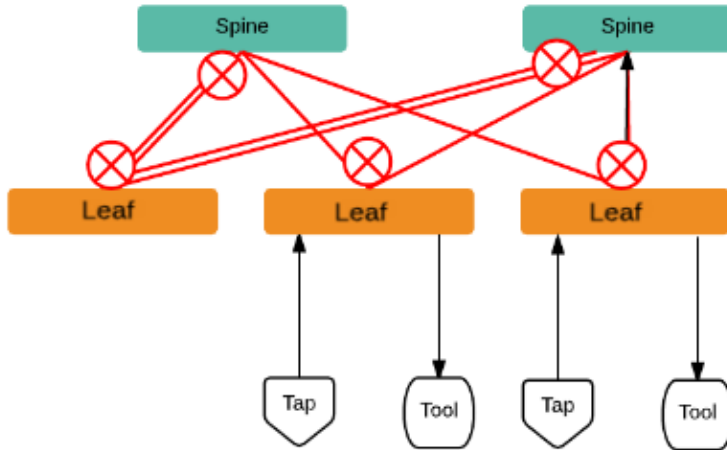


Figure 87: Leaf and Spine Architecture

In a cluster, the number of leaf nodes is typically greater than the number of spine nodes. In [Figure 87: Leaf and Spine Architecture](#), there are three leaf nodes and two spine nodes. The leaf nodes aggregate to a fewer number of spine nodes.

In [Figure 87: Leaf and Spine Architecture](#), the spine nodes are GigaVUE TA Series nodes, such as GigaVUE-TA100, while the leaf nodes are GigaVUE H Series nodes, such as GigaVUE-HC2, GigaVUE-HC3, which places the traffic intelligence at the edge.

[Figure 87: Leaf and Spine Architecture](#) shows TAPs or tools connecting to the leaf nodes, and the leaf nodes connecting to the spine nodes. Note that TAPs or tools do not connect to the spine nodes.

Instead of one leaf node connecting to one spine node with a single link, in this architecture there are multiple links from the leaf nodes to the spine nodes. The leaf nodes connect to the spine nodes through at least two paths. Some leaf nodes with higher capacity, such as GigaVUE-TA100, can have more paths, as shown by double red lines in [Figure 87: Leaf and Spine Architecture](#).

Traffic between ports on a leaf node will be local to that leaf node, but traffic between leaf nodes will go through the spine nodes.

The traffic from a source leaf node to a destination leaf node flows as follows:

- From a TAP, traffic flows to the source leaf node
- From the source leaf node, traffic is load balanced to all spine nodes
- From a spine node, traffic flows to the destination leaf node
- From the destination leaf node, traffic flows to tool ports

Resiliency is achieved when there are multiple paths from the network to the tools across GigaVUE nodes.

Path Protection

The spine leaf architecture in the cluster environment provides failover for the following:

- leaf node failure. Refer to [Leaf Node Failure](#).
- stack link failure on a leaf node (not connected to a tool, but can be connected to a network TAP). Refer to [Stack Link Failure on Leaf \(TAP Connected\)](#).
- spine node failure. Refer to [Spine Node Failure](#).
- stack link failure on a leaf node (connected to a tool). Refer to [Stack Link Failure on Leaf \(Tool Connected\)](#).

Leaf Node Failure

Refer to [Figure 88: Leaf Node Failure](#) for a failure in which a leaf node is powered down or rebooted. The leaf node does not have a connected TAP or tool.

NOTE: In the following figures, red arrows indicate traffic direction.

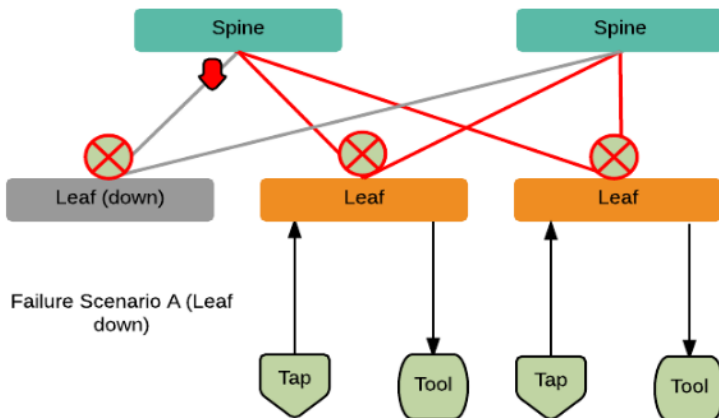


Figure 88: Leaf Node Failure

Restoration

Once the leaf node is powered up and booted, it will restore its traffic configuration.

Affected Time

None. Traffic on other leaf nodes will not be affected.

Stack Link Failure on Leaf (TAP Connected)

Refer to [Figure 89: Stack Link Failure on Leaf \(TAP Connected\)](#) for a failure in which a stack link on a leaf node fails and the leaf node is connected only to a TAP.

With this type of failure, the stack link between the leaf and spine nodes goes down. No action will be required at the spine node. At the leaf node, the affected link will be removed from the stack GigaStream. Traffic will be sent to the other spine node.

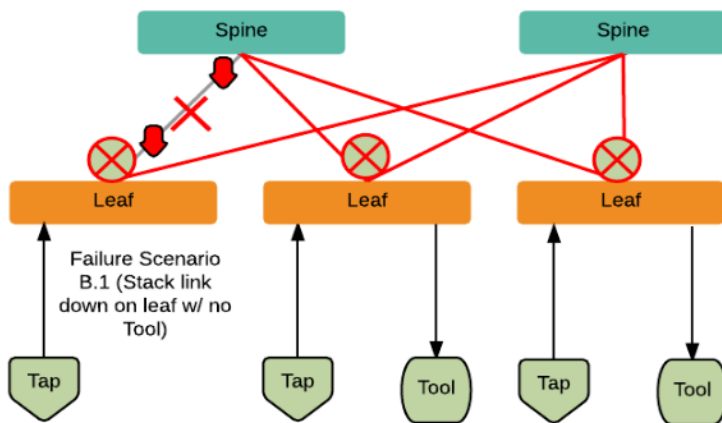


Figure 89: Stack Link Failure on Leaf (TAP Connected)

Restoration

When the link comes back up, the leaf node will put the link back into the GigaStream.

Affected Time

When the link is down, traffic recovers in a similar amount of time as a tool GigaStream.

Spine Node Failure

Refer to [Figure 90: Spine Node Failure](#) for a failure in which a spine node is powered down or rebooted.

With this type of failure, the stack link between the leaf and spine nodes goes down. The leaf nodes will detect that the stack link is down. The affected link will be removed from the stack GigaStream. Traffic will be load balanced to the other spine node.

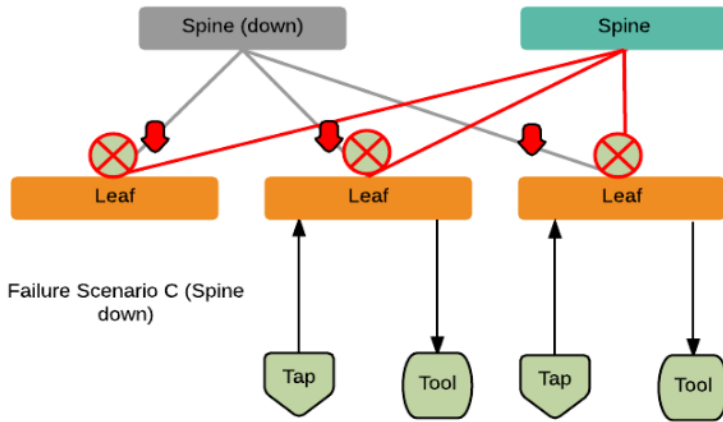


Figure 90: Spine Node Failure

Restoration

When the spine node reboots, the cluster will synchronize. When the node converges to the cluster and the configuration synchronizes, traffic will be restored.

Affected Time

When the spine node is powered down or rebooted, traffic recovers in a similar amount of time as a tool GigaStream.

Stack Link Failure on Leaf (Tool Connected)

Refer to [Figure 91: Stack Link Failure on Leaf \(Tool Connected\)](#) for a failure in which a stack link between the leaf and spine nodes fails and the leaf node is connected to a tool.

In the current software version, this type of failure is not supported.

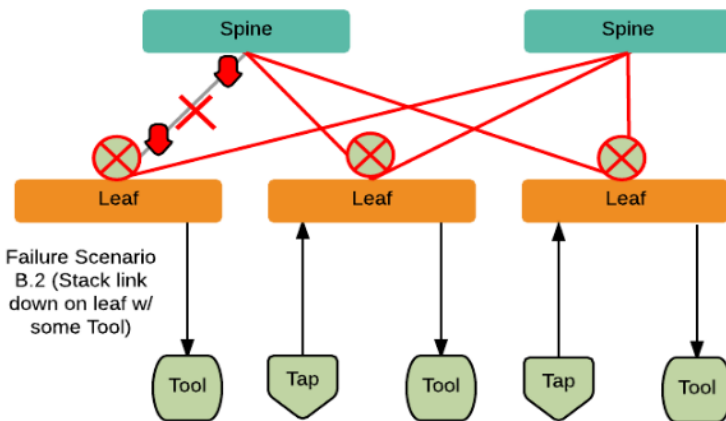


Figure 91: Stack Link Failure on Leaf (Tool Connected)

Configuration Overview

This section provides an overview of the configuration. The configuration is done from the master node in the cluster. Follow this configuration sequence to prevent loops.

This configuration connects nodes using multiple paths. For an example of the configuration, refer to [Figure 92: Leaf and Spine Configuration](#).

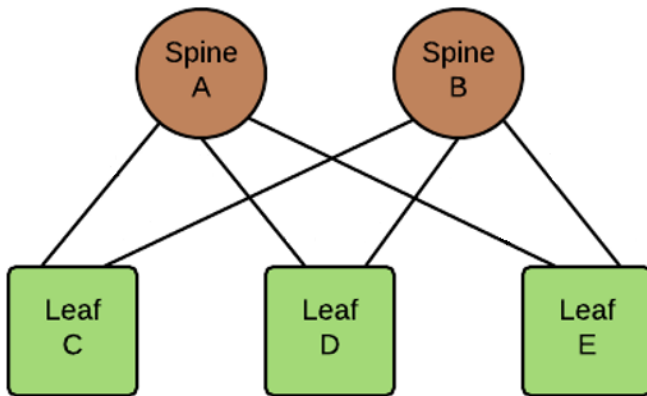


Figure 92: Leaf and Spine Configuration

The configuration steps are as follows:

- Configure stack GigaStream. The stack GigaStream connect the spine and leaf nodes. In [Figure 93: Stack GigaStream Configuration](#), the stack GigaStream are: a1, a2, a3, b1, b2, b3, c1, c2, d1, d2, e1, e2. Even if there is only one port that connects the nodes, you must still configure a stack GigaStream. With a configuration of two spine nodes and three leaf nodes, the number of stack GigaStream is 12.

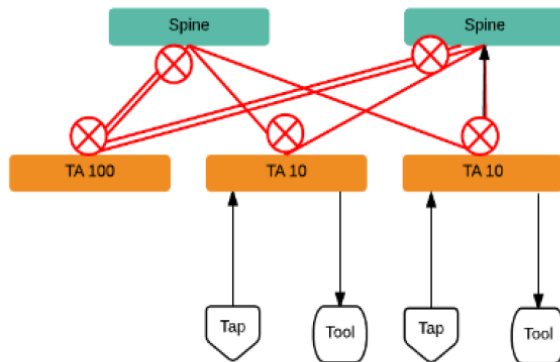


Figure 14-7: Stack GigaStream Configuration

Figure 93: Stack GigaStream Configuration

- Configure spine links. On each leaf node, there is one spine link that contains the list of GigaStream connecting the leaf nodes to the spine nodes. The spine links contain multiple stack GigaStream that are bundled together. The spine links are: {c1,c2}, {d1,d2}, and {e1,e2}. The total number of spine links is three for this configuration. The spine links are located at the leaf nodes. Across the spine link members, traffic is load balanced. For this part of the configuration, refer to the circles in [Figure 94: Spine Link Configuration](#).

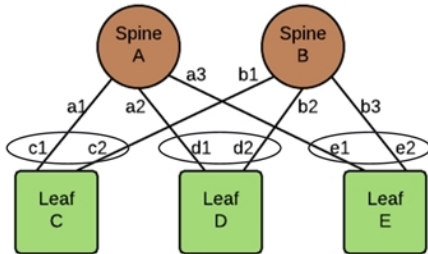


Figure 94: Spine Link Configuration

NOTE: For the spine links, make sure that all paths are reachable.

- Configure stack links. The stack links are: {a1,c1}, {a2,d1}, {a3,e1}, {b1,c2}, {b2, d2}, and {b3, e2}. The total number of stack links is six for this configuration. For this part of the configuration, refer to the circles in [Figure 95: Stack Link Configuration](#).

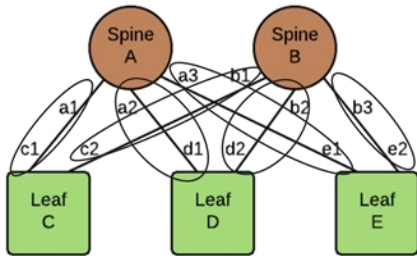


Figure 95: Stack Link Configuration

These configuration steps ensure that the spine and leaf nodes are fully meshed.

Notes and Considerations

Refer to the following notes and considerations:

- The multi-path leaf and spine architecture is only supported in an out-of-band cluster.
- The spine link GigaStream must be of type stack. Stack GigaStream carry bi-directional traffic.
- All spine link GigaStream must have the same parameters, such as the same hash value and failover mode.

- Once a spine link is configured, editing of GigaStream parameters is not supported, except for editing the comment.
- Adding a new node to an existing leaf-spine topology is not supported. If you need to add a new node, ensure that you remove the existing configurations and reconfigure them for the new topology.
- GigaStream must be configured before spine links are configured.
- Once a GigaStream is configured in a spine link, it cannot be deleted. To delete a spine link, the stack links must first be deleted.
- A spine link cannot be deleted if a map is using the spine link.
- A spine link cannot be created if a map is using the GigaStream.

The number of spine and leaf nodes is not limited. The ratio of spine and leaf nodes are determined by the cluster traffic needed between the leaf nodes. Larger topologies have the same restrictions as the GigaVUE-OS as follows:

- the total number of nodes in a cluster, for example, 32
- the number of links in a GigaStream (which depends on the GigaVUE node and line card or module, for example, the PRT-HC0-X24 module on GigaVUE-HC2 can have 24 stack GigaStream)

Leaf-Spine Cluster Deployment

This section describes the steps and prerequisites to deploy a leaf-spine cluster.

Refer to [Introduction to Multi-Path Leaf and Spine](#) for a conceptual overview of the leaf-spine architecture.

Deployment Checklist

Before forming a Leaf-Spine Cluster, it is strongly recommended that you get familiar with the relevant documentation and review the deployment checklist to prepare for deployment.

Pre-deployment checklist

- Gigamon Fabric Management must be upgraded to GigaVUE-FM 5.3.00 or later
- Gigamon device must be upgraded to GigaVUE-OS 5.2.00 or later
- Advanced Features License must be installed in TA devices
- Physical connection must be established to create stack links
- Devices must have GDP enabled and be physically connected to create links among devices from GigaVUE-FM.

IMPORTANT: Recommendation is to use TA devices as SPINE Nodes and other devices as LEAF Nodes.

Formation Scenario

The Leaf-Spine cluster can be formed with different combinations of devices with four Spine and six Leaf nodes as a 10-node cluster.

The following configuration creates a leaf spine cluster with two spines and three leaves.

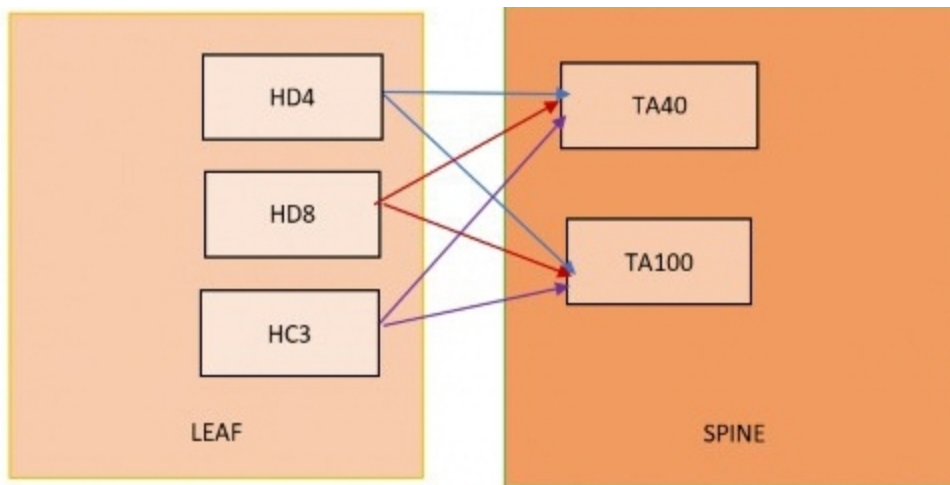


Figure 96: Leaf spine cluster overview,

NOTE: GigaStreams support different speeds, as indicated by the different colored connector lines in [Figure 96: Leaf spine cluster overview](#), .

Leaf-Spine Cluster Formation Workflow

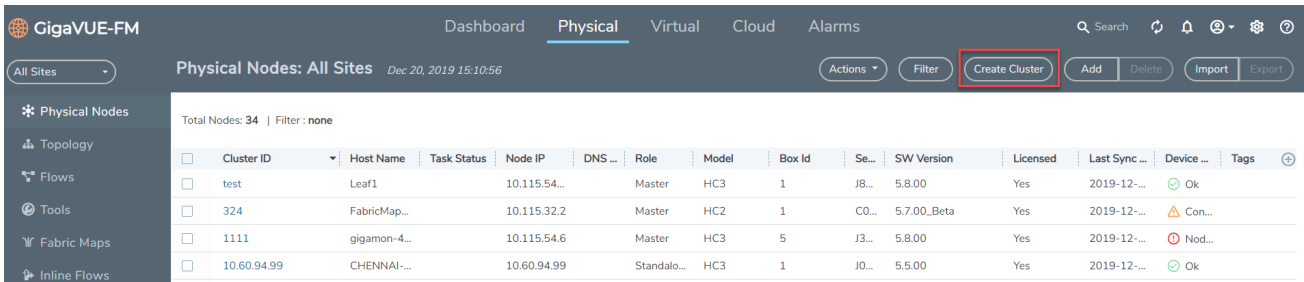
GigaVUE-FM 5.3 supports workflow-based configurations for forming a cluster. This workflow walks through the required steps to form a complete Leaf-Spine cluster. Additional procedures for editing and deleting cluster formations are also provided:

- [Create a Leaf-Spine Cluster](#)
- [Edit a Cluster](#)
- [Delete a Node from a Cluster](#)
- [How to Change the Master Preference of a Device](#)

Create a Leaf-Spine Cluster

To create a Leaf-Spine cluster:

1. Navigate to **Physical > Physical Nodes**.
2. Click **Create Cluster**.



Cluster ID	Host Name	Task Status	Node IP	DNS ...	Role	Model	Box Id	Se...	SW Version	Licensed	Last Sync ...	Device ...	Tags
test	Leaf1		10.115.54...		Master	HC3	1	J8...	5.8.00	Yes	2019-12-...	Ok	
324	FabricMap...		10.115.32.2		Master	HC2	1	C0...	5.7.00_Beta	Yes	2019-12-...	Con...	
1111	gigamon-4...		10.115.54.6		Master	HC3	5	J3...	5.8.00	Yes	2019-12-...	Nod...	
10.60.94.99	CHENNAI-...		10.60.94.99		Standalo...	HC3	1	J0...	5.5.00	Yes	2019-12-...	Ok	

Figure 97: Create Cluster

Select the Cluster Type

- The Create a Cluster screen opens with two options:
 - CREATE A CLUSTER
 - CREATE A LEAF SPINE CLUSTER
- Hover over the CREATE A LEAF SPINE CLUSTER option and click **Let's Begin** to start the wizard.

What do you want to do?

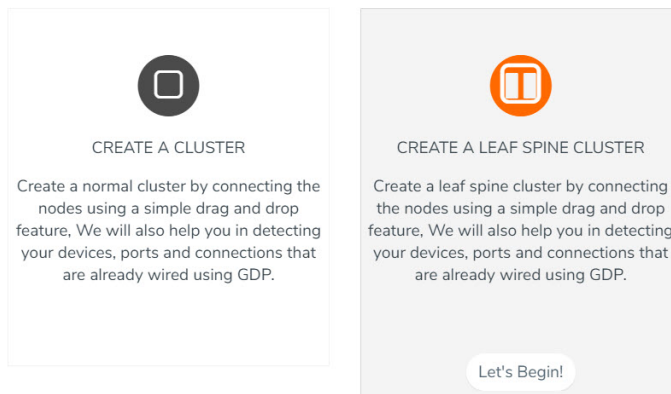


Figure 98: Choose CREATE A LEAF SPINE CLUSTER

Select Devices

The wizard guides you through the cluster set-up. The first step is to select the devices in your cluster.

- The Select Devices page displays a list of standalone devices with filter options:
 - Software:** Filter the nodes based on the software version for which the cluster will be formed.
 - Model:** Filter the nodes based on a Gigamon model.
 - HostName:** Enter the HostName of the Gigamon Nodes to specify a device.

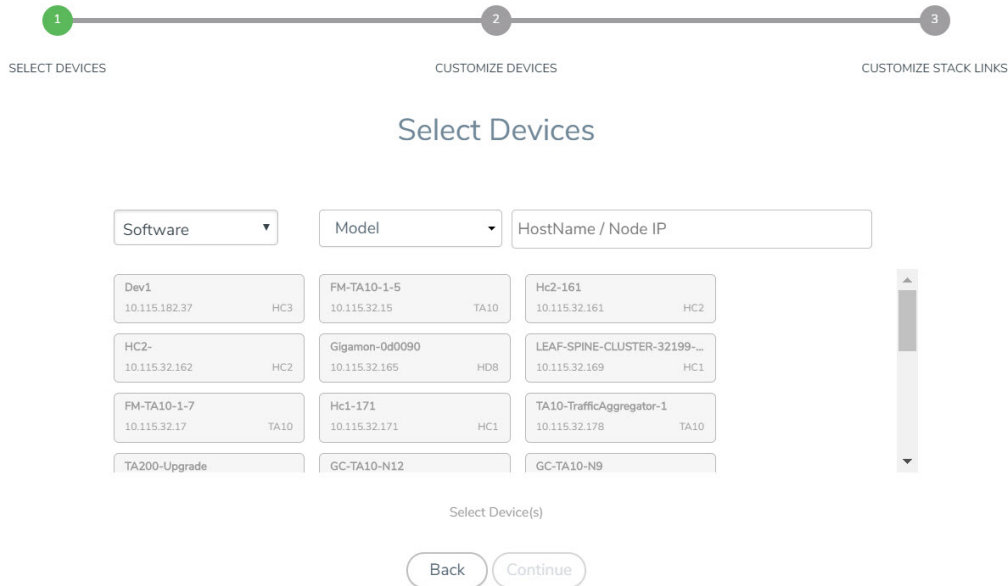


Figure 99: Select the required devices to form a cluster

Select the nodes to include in this cluster and click **Continue**.

- Click a device to select it. Click it again to deselect it. Selected devices are highlighted.

Customize Devices

Use the Cluster Configuration window to customize your devices.

- Enter a valid **Cluster ID** and **VIP** and select the master node in the **Seed Node** list.

NOTE: TA devices cannot be a master node.

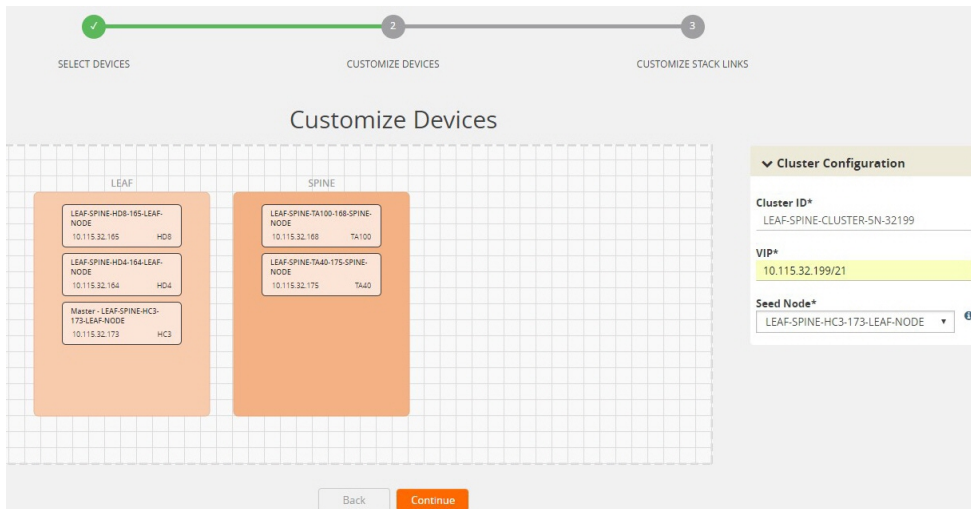


Figure 100: Enter cluster configuration details

- After completing the Cluster Configuration details, click **Continue**.

NOTE: Use the **Back** button to return to the Select Devices page to revise the selection of devices for this cluster.

Customize Stack Links for your Leaf-Spine configuration

Finally, customize the stack links to define how the nodes should be connected.

- If GDP (Gigamon Discovery Protocol) is enabled at the device chassis level, then the corresponding ports used to create links and ports should be admin enabled. If a physical connection exists in the device, then the links will be shown.

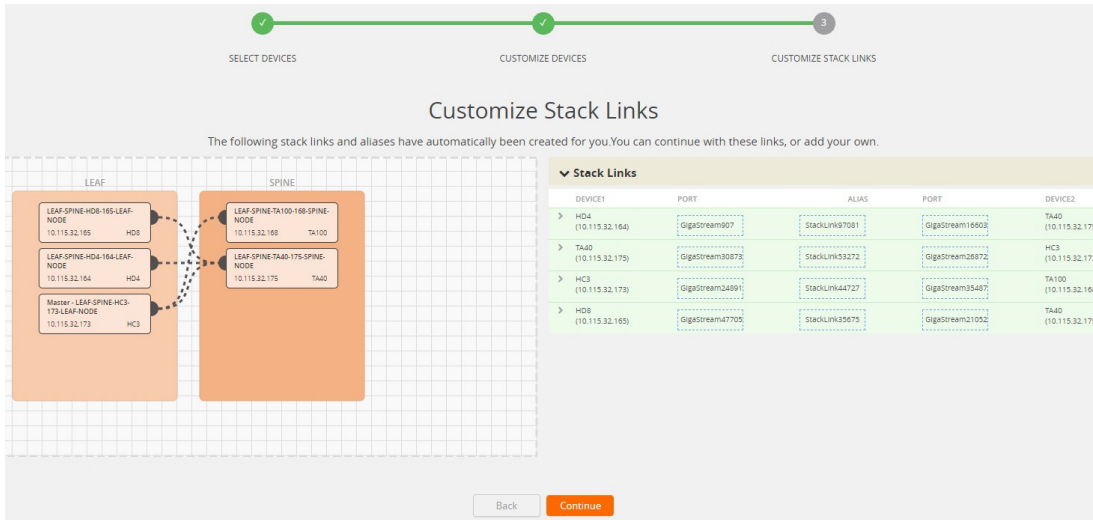


Figure 101: If GDP is enabled, the existing links appear in the cluster canvas

- If GDP is not enabled in the ports, then the links will need to be drawn to connect the devices.

Connect Leaf devices with Spine devices to create a stack link between them.

Click the tip of the node and drag your cursor to the second node tip to create a link. After you create the link, a dotted line will illustrate the connection.

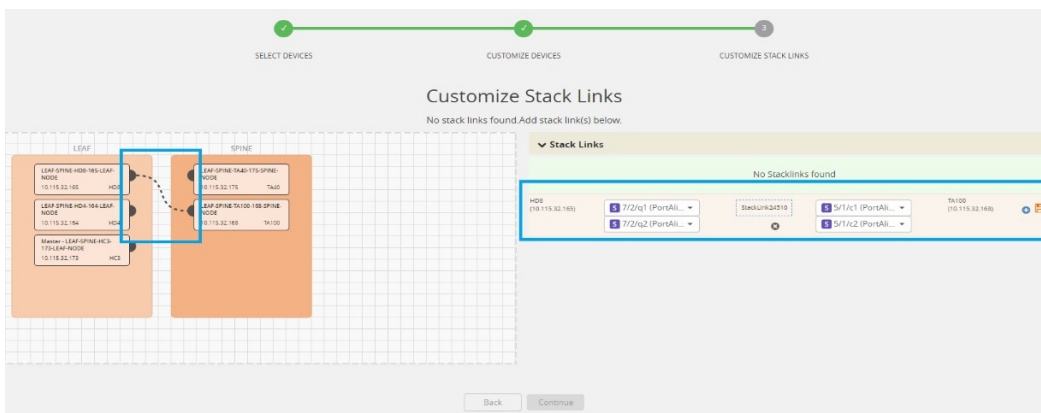


Figure 102: If GDP is not enabled, create stack links by connecting the links between leaf and spine

- Configure the formed links in the Stack Links table as follows:

- Select ports in each device that are compatible, for example: x-x ports ,x-q ports, q-c ports, x-c ports.
- Select two or more ports in each device to create a stack GigaStream.
- After selecting the ports, save the stack link by clicking Save button enabled in the right of stack link table.

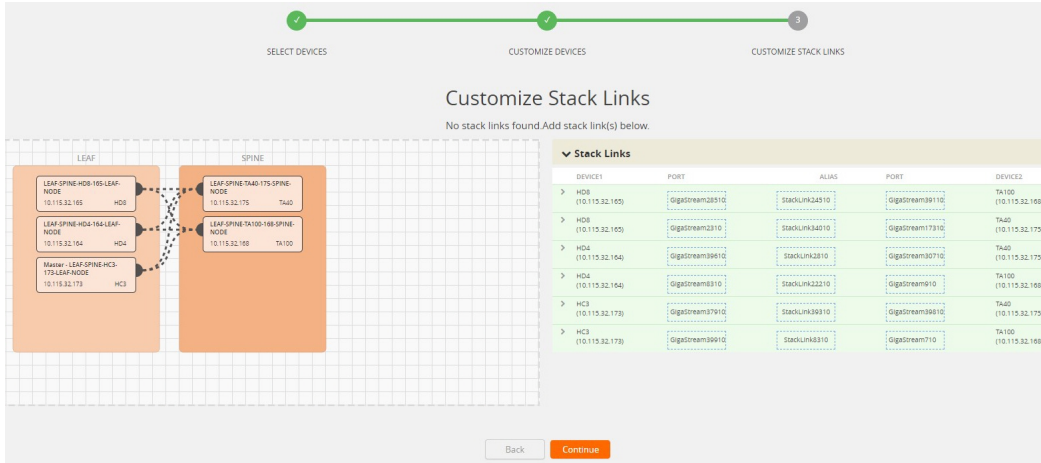


Figure 103: Stack link table to create the required GigaStream and stack link

Stack GigaStreams and stack links can act as a spine link between the devices. The alias for stack link and GigaStream is auto generated by GigaVUE-FM. This alias can be edited as needed.

12. After the required Stack Links and GigaStreams are created and saved, click **Continue** to start the cluster creation process.

The Creating Cluster page appears as the cluster is being created.



Figure 104: Notification window starts once the cluster formation is in progress

The Create Cluster progress window in the lower right corner of the page shows the status of every node as it joins the cluster. It takes a few minutes for the cluster to form. The cluster creation process involves the following steps:

- Cluster[clusterName] Creation Successful followed by Seed device
- Verifying Nodes[Will display HostName of all devices]
- Adding Node[HostName] to cluster [clusterName]
- Node[HostName] successfully joined to the cluster.
- Configuring cards for cluster[clusterName]

- Rediscovering cluster[clusterName]
- Configuring ports for cluster[clusterName].
- Configuring ports will display the status of each stack link and GigaStream whether the creation is successful or not.

Source	Time	Scope	Event Type	Severity	Affected Entity Type	Affected Entity	Description	Device IP	Host Name
FM	2018-03-21 16:22:38	phyNode	DeviceStateChanged	Info	--	--	Device [DeviceIp: 10.115.32.173]	10.115.32.173	LEAF-SPINE-HC3-173-LEAF-
10.60.80.43	2018-03-21 16:22:17	phyNode	TrapPolicyTrigger	Info	Chassis	--	Device [DeviceIp: 10.115.32.173, ChassisId: LEAF-SPINE-CLUSTER] state changed: Role [Standby] --> [Master]	10.60.80.43	Chennai-HC2
10.60.80.43	2018-03-21 16:22:16	phyNode	TrapConfigSave	Info	Chassis	--	[10.60.80.43] - Config Sa...	10.60.80.43	Chennai-HC2
10.60.80.43	2018-03-21 16:21:17	phyNode	TrapPolicyTrigger	Info	Chassis	--	Active Visibility Policy Te...	10.60.80.43	Chennai-HC2
10.60.80.43	2018-03-21 16:21:16	phyNode	TrapConfigSave	Info	Chassis	--	[10.60.80.43] - Config Sa...	10.60.80.43	Chennai-HC2
10.60.80.43	2018-03-21 16:20:18	phyNode	TrapPolicyTrigger	Info	Chassis	--	Active Visibility Policy Te...	10.60.80.43	Chennai-HC2
10.60.80.43	2018-03-21 16:20:17	phyNode	TrapConfigSave	Info	Chassis	--	[10.60.80.43] - Config Sa...	10.60.80.43	Chennai-HC2
10.60.80.43	2018-03-21 16:19:18	phyNode	TrapPolicyTrigger	Info	Chassis	--	Active Visibility Policy Te...	10.60.80.43	Chennai-HC2
10.60.80.43	2018-03-21 16:19:17	phyNode	TrapConfigSave	Info	Chassis	--	[10.60.80.43] - Config Sa...	10.60.80.43	Chennai-HC2
10.60.80.43	2018-03-21 16:18:18	phyNode	TrapPolicyTrigger	Info	Chassis	--	Active Visibility Policy Te...	10.60.80.43	Chennai-HC2
10.60.80.43	2018-03-21 16:18:17	phyNode	TrapConfigSave	Info	Chassis	--	[10.60.80.43] - Config Sa...	10.60.80.43	Chennai-HC2
FM	2018-03-21 16:17:50	phyCluster	NodeJoinedToCluster	Info	--	--	Node --> [10.115.32.173]	10.115.32.173	LEAF-SPINE-HC3-173-LEAF-I
10.60.80.43	2018-03-21 16:17:18	phyNode	TrapPolicyTrigger	Info	Chassis	--	Active Visibility Policy Te...	10.60.80.43	Chennai-HC2
10.60.80.43	2018-03-21 16:17:17	phyNode	TrapConfigSave	Info	Chassis	--	[10.60.80.43] - Config Sa...	10.60.80.43	Chennai-HC2
FM	2018-03-21 16:17:07	phyCluster	ClusterCreationStarted	Info	--	--	Cluster [LEAF-SPINE-CLU...	10.115.32.173	LEAF-SPINE-HC3-173-LEAF-I
10.60.80.43	2018-03-21 16:16:18	phyNode	TrapPolicyTrigger	Info	Chassis	--	Active Visibility Policy Te...	10.60.80.43	Chennai-HC2
10.60.80.43	2018-03-21 16:16:17	phyNode	TrapConfigSave	Info	Chassis	--	[10.60.80.43] - Config	10.60.80.43	Chennai-HC2

Figure 105: Record in events page during cluster creation event

When the cluster formation process is complete the notification window will display a, "Create Cluster Completed," message.

13. Click **Go to Cluster** to view the cluster overview.

Edit a Cluster

The Edit cluster option supports only the following operations to the existing cluster:

- Multiple devices can be added to the existing cluster in a single update operation.
- Multiple devices can be added as Leaf, Spine, Leaflet.
- Stack links can be created only from the new device which is added into the cluster wizard.
- Master preferences can be changed for each device through edit cluster option.
- Stack link alias and GigaStream alias can be edited for newly created links.

NOTE:

- No option to remove the existing stack links through cluster wizard.
- No option to create links in existing devices.
- Addition and deletion of devices in a single update operation should not be appreciated.
- No option to edit the existing stack link alias and GigaStream alias.

Prerequisites

Standalone devices that have maps cannot be added to cluster if ports used in maps overwrites with the selected ports in stack link table.

This workflow describes how to add a node to a cluster.

1. Select a cluster and choose **Actions > Edit cluster**.

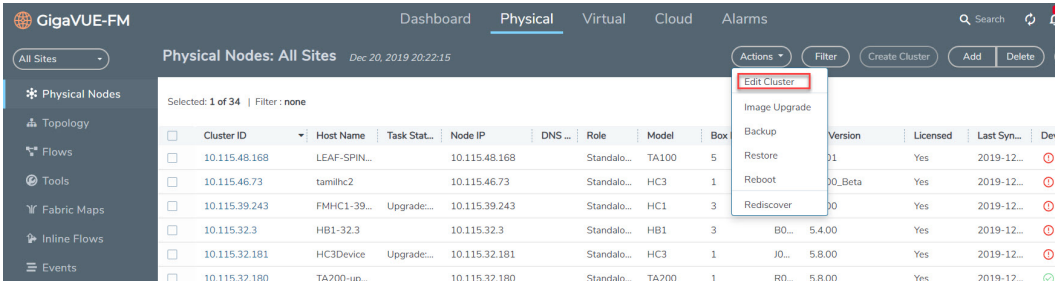


Figure 106: Edit cluster

2. The Edit Leaf Spine Cluster Canvas displays the existing stack link configuration details in the cluster wizard canvas. Standalone devices are listed under the Devices pane.

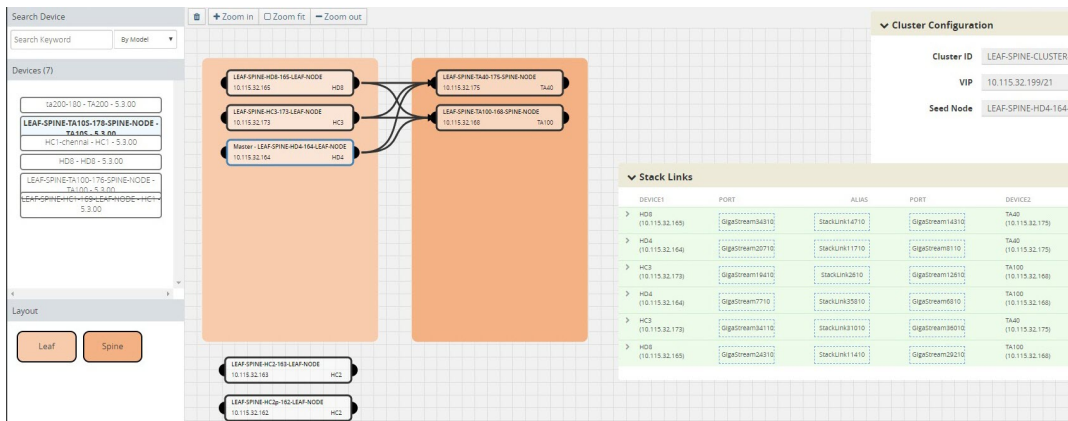


Figure 107: Drag required devices into canvas

3. Drag the required devices from the devices pane into the cluster wizard under the leaf or spine container.
4. Draw the links between the newly added device. (**NOTE:** no new link is created for the existing device.)

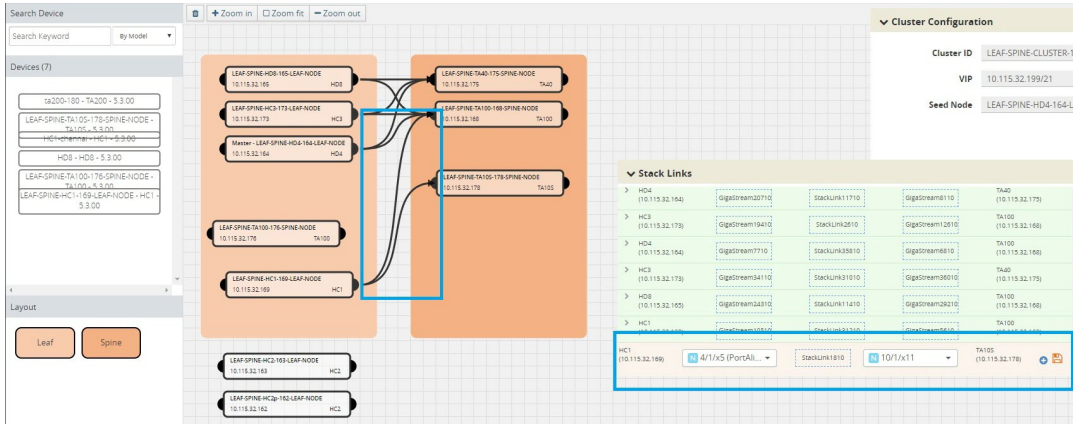


Figure 108: Create links between devices

5. Configure the stack link details in the stack link table.
6. After selecting the ports, save the stack link by clicking **Save** in the stack link table
7. Click **Update** to initiate the update process.
8. When prompted by the Confirmation message, click **OK** to run the cluster update.

When the cluster update operation starts, a notification window will appear at the right corner of the GigaVUE-FM window to show the status progression of each node, card, GigaStream and stack link.

When the cluster update operation is completed, "Manage Cluster Completed," will appear in the in the Manage Cluster notification window.

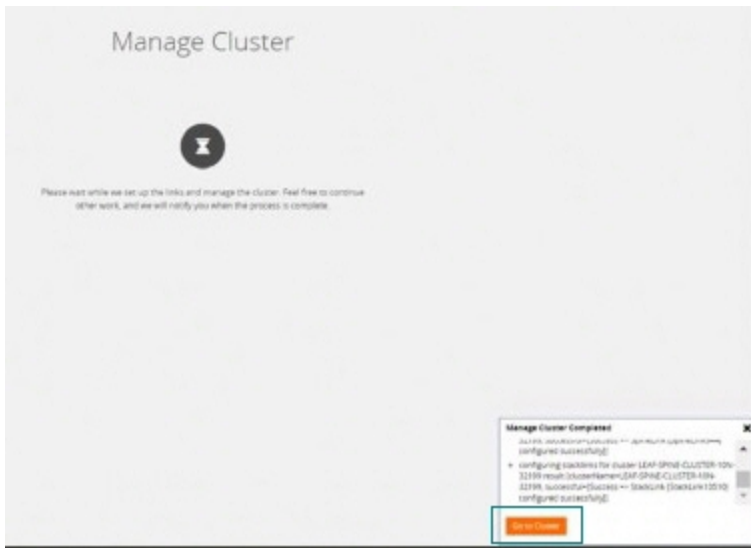


Figure 109: Manage Cluster Completed notification

9. Click **Go to Cluster** to go to view the cluster overview.

Cluster ID	Host Name	Box ID	Node IP	DNS Name	Role	Model	SW Version	Licensed	Last Sync Time	Device Status	Task Status
LEAF-SPINE-CLUSTER	LEAF-SPINE-TA40-1...	2	10.115.32.175		Normal	TA40	5.3.00	Yes		At least 50 % of p...	
LEAF-SPINE-CLUSTER	LEAF-SPINE-TA100...	5	10.115.32.168		Normal	TA100	5.3.00	Yes		At least 50 % of p...	
LEAF-SPINE-CLUSTER	LEAF-SPINE-TA105...	10	10.115.32.178		Normal	TA105	5.3.00	Yes		At least 50 % of p...	
LEAF-SPINE-CLUSTER	LEAF-SPINE-HC1-16...	4	10.115.32.169		Normal	HC1	5.3.00	Yes		At least 50 % of p...	
LEAF-SPINE-CLUSTER	LEAF-SPINE-HD8-1...	7	10.115.32.165		Standby	HD8	5.3.00	Yes		100 % of power c...	
LEAF-SPINE-CLUSTER	LEAF-SPINE-HC2-16...	3	10.115.32.163		Normal	HC2	5.3.00	Yes		Ok	
LEAF-SPINE-CLUSTER	LEAF-SPINE-HC2p-1...	8	10.115.32.162		Normal	HC2	5.3.00	Yes		Ok	
LEAF-SPINE-CLUSTER	LEAF-SPINE-HC3-17...	1	10.115.32.173		Normal	HC3	5.3.00	Yes		Ok	
LEAF-SPINE-CLUSTER	LEAF-SPINE-HD4-1...	6	10.115.32.164		Master	HD4	5.3.00	Yes	2018-03-20 16:29:14	Ok	
LEAF-SPINE-CLUSTER	LEAF-SPINE-TA100...	9	10.115.32.176		Normal	TA100	5.3.00	Yes		At least 50 % of p...	

Figure 110: Cluster details in the Physical Nodes page

The created GigaStreams will appear in the device Port Groups page, and the created stack links will appear in the device Stack Links page.

Delete a Node from a Cluster

This workflow describes how to remove a device node from a cluster.

NOTE: Only one device can be removed from the cluster per update operation.

The device should not contain any map configurations in a cluster. Those devices cannot be removed until the maps are present.

1. Select a cluster and choose **Actions > Edit cluster**.

Cluster ID	Task Status	Node IP	Model	SW Version	Device Status	Tags
10.60.95.179		10.60.95.179	HC3	5.9.00	Node is unr...	
10.60.94.30	Upgrade: Failed	10.60.94.30	HC2	5.9.00	50 % of the ...	
10.115.78.30		10.115.78.30	HC1	5.9.00	Authenticati...	
10.115.38.77		10.115.38.77	Standalone	HC1	5.9.00	Node is unr...
cluster-hc3-hd8		10.115.26.85	Master	HC3	5.9.00	Node is unr...
cluster-hc3-hd8		10.115.26.81	Master	HD8	5.9.00	Node is unr...
10.115.32.165		10.115.32.165	Standalone	HD8	5.9.00_Beta	Node is unr...
10.115.38.70		10.115.38.70	Standalone	HC2	5.9.00_Beta	Rediscovery...
10.115.38.130		10.115.38.130	Standalone	HC3	5.9.00_Beta	Ok
ripper		10.115.38.14	Master	HD4	5.9.00_Beta	Config sync...

Figure 111: Edit cluster

Only one device can be deleted from the canvas. It can be either Leaf, Spine or Leaflet.

2. To remove a device, right-click the device to be removed from the canvas and click **Remove**.

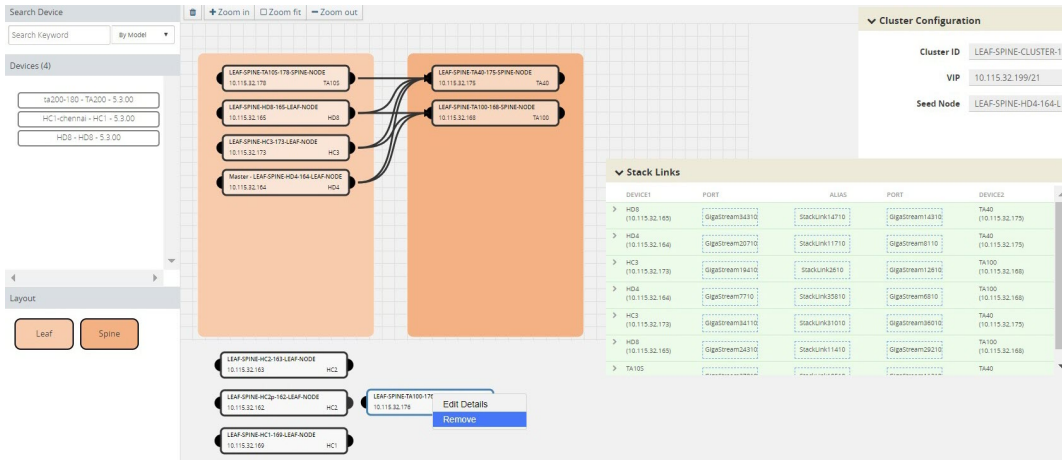


Figure 112: Right click the device and remove

The removed device will be deleted from canvas.

3. Click **Update** to initiate the cluster-update operation.

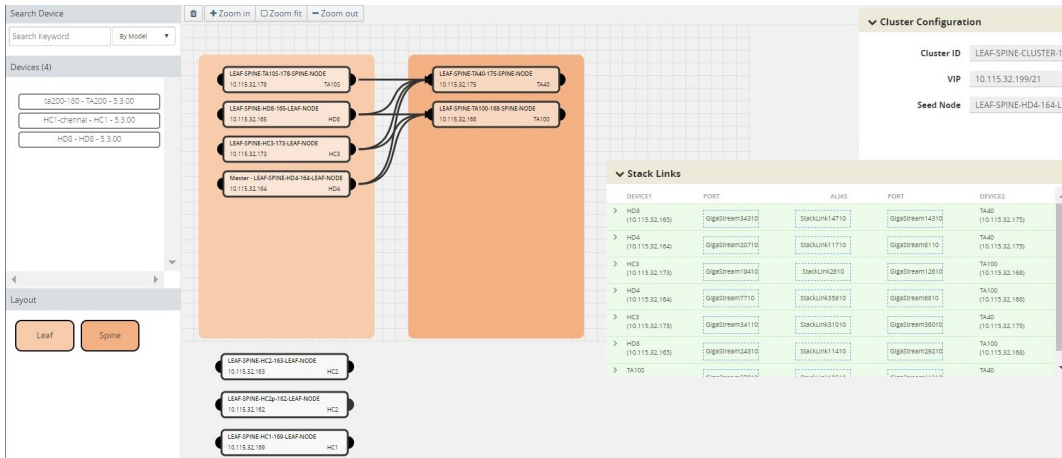


Figure 113: Remove will delete the device from canvas

The Manage Cluster notification window shows the progress of nodes being removed from the cluster.

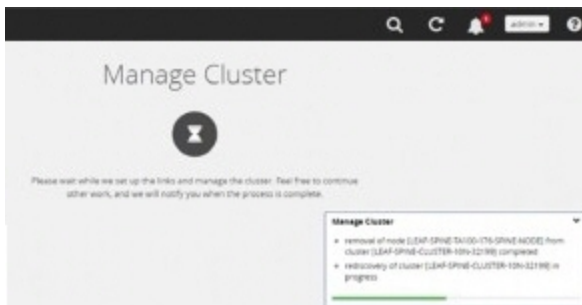


Figure 114: Notification for deleting a device from a cluster

When the device is successfully removed from the cluster, a “Manage Cluster Completed,” message will appear in the notification window.

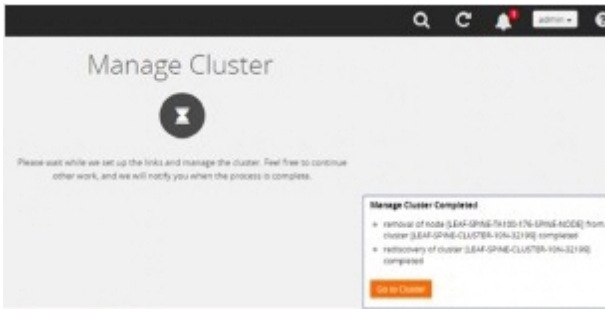


Figure 115: Cluster completion status window

4. Click **Go To Cluster** to go into device overview page and see the cluster details.

How to Change the Master Preference of a Device

This workflow describes how to change the device's master preference.

1. Select a cluster and choose Edit cluster under Actions.

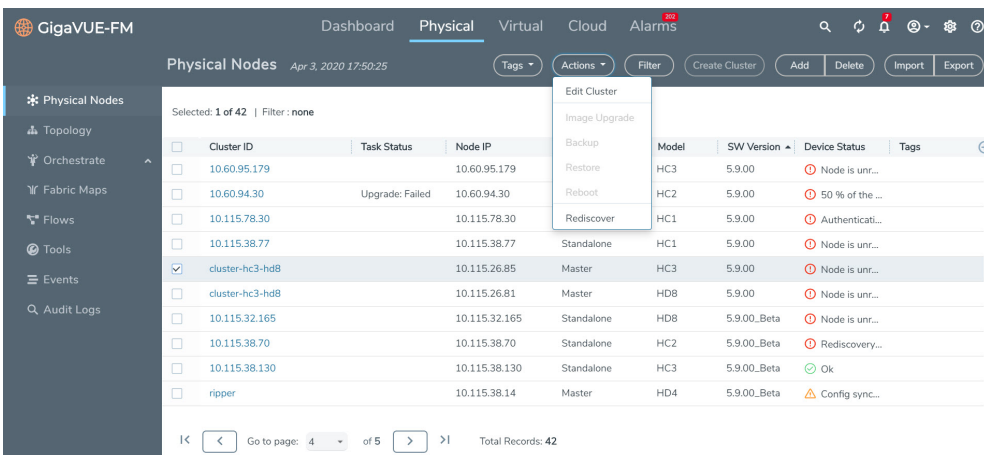


Figure 116: Edit cluster

2. To set the master preference for a device, right-click the device and click the **Edit Details** option.

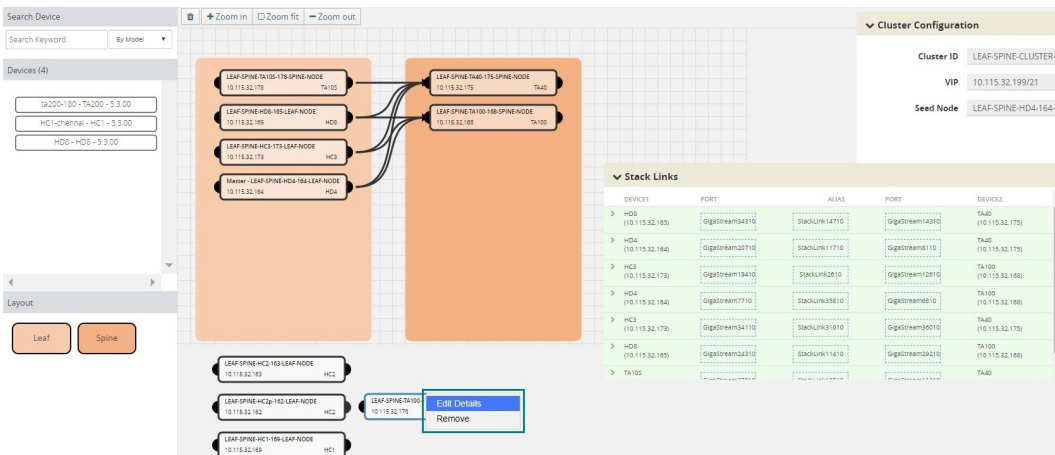


Figure 117: Edit details by right clicking the node

- Click a device in the Edit Leaf Spine Cluster canvas to display the device configuration quick view.

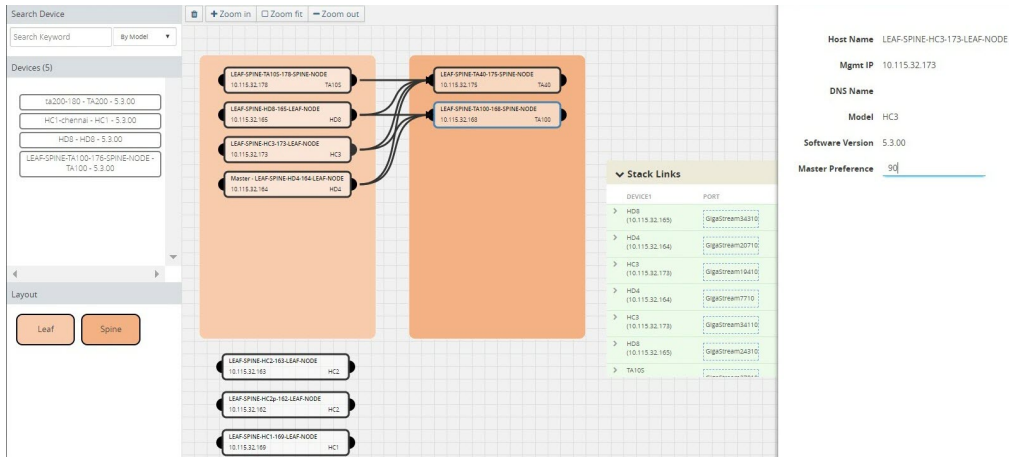


Figure 118: Set Master preference

- Update the master preference text box and click **Update** to proceed.

The Manage Cluster notification will appear to show the progress of the cluster update. When the process is complete, a “Manage Cluster Completed,” message will appear in the notification window.

- Click **Go To Cluster** to go to the device overview page and see the cluster details.

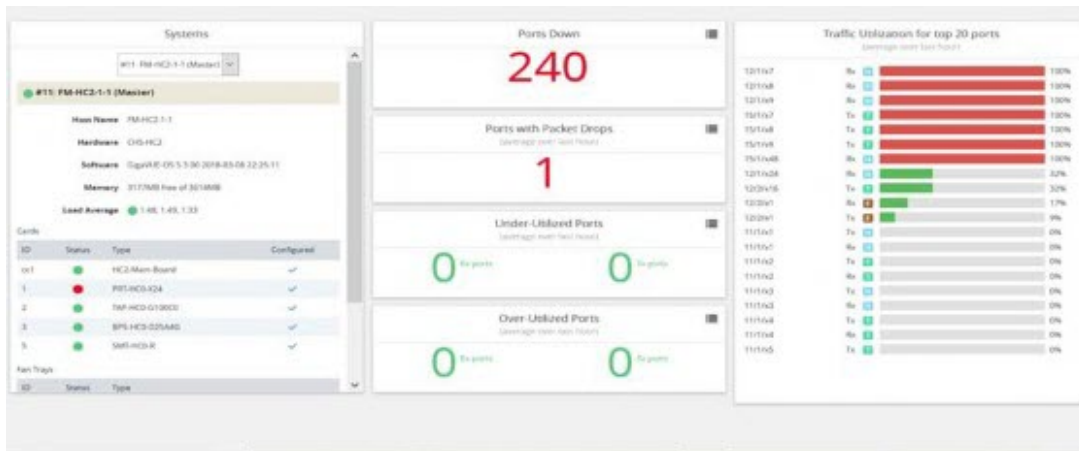


Figure 119: Cluster overview page after formation

Spine to Spine and Leaf

This chapter describes the Spine to Spine and Leaf architecture for achieving high availability in a cluster environment. Refer to the following sections for details:

- [Introduction to Spine to Spine and Leaf](#)
- [Configuration Overview](#)

- Configuration of Spine to Spine and Leaf Architecture
- Leaf-Spine Cluster Deployment

NOTE: Refer to [Regular Cluster Formation Workflow](#) for how to use the Regular Cluster workflow.

Introduction to Spine to Spine and Leaf

The Spine to Spine and Leaf architecture is a multi-layer architecture used for network aggregation. This architecture supports leaf nodes and multiple levels of spine nodes. In Spine to Spine and Leaf architecture, connect the leaf and spine as follows:

- 1 Leaf nodes to the TAPs or tools.
- 2 First level spine nodes to the leaf nodes and the second level spine nodes.
- 3 Second level spine nodes to all first level spine nodes.

With multiple paths between the nodes in a cluster, the spine to spine and leaf architecture protects against traffic congestion, failures, such as stack link or spine node failures. In the event of a failure, the traffic on one path fails over to the other path. This architecture provides resiliency to the network.

An example of a Spine to Spine and Leaf architecture is shown in [Figure 120: Spine to Spine and Leaf Architecture](#).

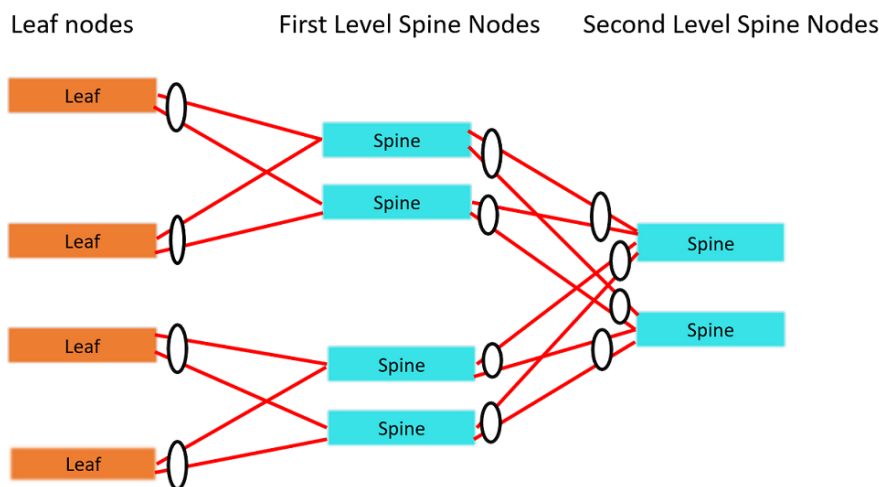


Figure 120: Spine to Spine and Leaf Architecture

In a Spine-Leaf cluster, the number of leaf nodes is typically higher than the number of spine nodes. In [Figure 120: Spine to Spine and Leaf Architecture](#), there are four leaf nodes, four first level spine nodes, and two second level spine nodes. The leaf nodes aggregate to a fewer number of spine nodes.

For more information on Spine to Leaf architecture, refer to [Multi-Path Leaf and Spine](#).

In [Figure 120: Spine to Spine and Leaf Architecture](#), the spine nodes are GigaVUE TA Series nodes, such as GigaVUE-TA100, TA40, TA10, or TA200 while the leaf nodes are GigaVUE H Series nodes, such as GigaVUE-HC2, or GigaVUE-HC3 which places the traffic intelligence at the edge.

Traffic between ports on the same leaf node will be local to that leaf node, but traffic between different leaf nodes will go through the spine nodes.

The traffic from a source leaf node to a destination leaf node flows as follows:

- From a TAP, traffic flows to the source leaf node.
- From the source leaf node, traffic is load balanced to the connected spine nodes.
- From the spine node, depending on the configuration, traffic flows to the next level of spines or the destination leaf node.
- From the destination leaf node, traffic flows to the tool ports.

Resiliency is achieved when there are multiple paths from the network to the tools across GigaVUE nodes.

Refer to [Path Protection](#) for the leaf node failure, stack link failure on a leaf node or spine node.

Configuration Overview

This section provides an overview of the configuration. You must perform the configuration from the master node in the cluster. Follow this configuration sequence to prevent loops:

1. [Configure Stack GigaStream](#)
2. [Configure Spine Links](#)
3. [Configure Stack Links](#)

This configuration connects nodes using multiple paths. For an example of the configuration, refer to [Figure 121: Spine to Spine and Leaf Configuration](#).

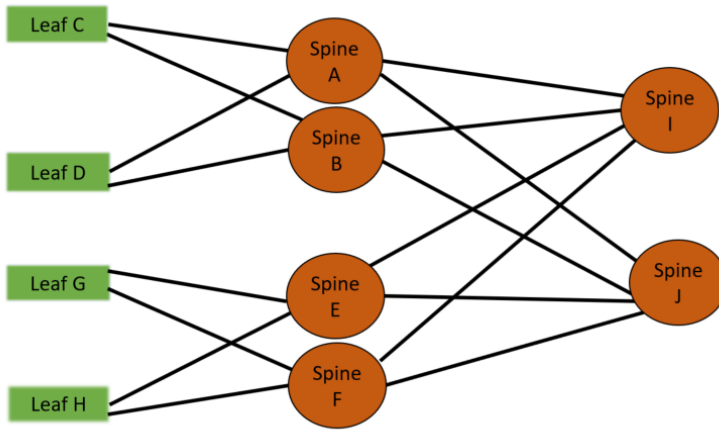


Figure 121: Spine to Spine and Leaf Configuration

Configure Stack GigaStream

The stack GigaStream connect the spine and leaf nodes. In [Figure 122: Stack GigaStream Configuration](#), the stack GigaStream are: a1, a2, a3, a4, b1, b2, b3, b4, c1, c2, d1, d2, e1, e2, e3, e4, f1, f2, f3, f4, g1, g2, h1, h2, i1, i2, i3, i4, j1, j2, j3, j4. Even if there is only one port that connects the nodes, you must still configure a stack GigaStream. With a configuration of 6 spine nodes and 4 leaf nodes, the number of stack GigaStream is 32.

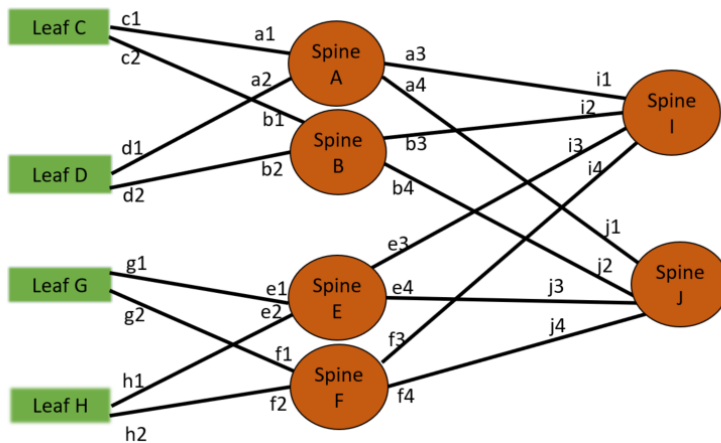


Figure 122: Stack GigaStream Configuration

Configure Spine Links

On each leaf node, there is one spine link that contains the list of GigaStream connecting the leaf nodes to the spine nodes. The spine links contain multiple stack GigaStream bundled together. The spine links on the leaf nodes are: {c1,c2}, {d1,d2}, {g1, g2} and {h1, h2}.

The spine node also contains the spine links. A spine node connecting to another spine nodes has a spine link. The spine links on the spine nodes are: {a3, a4}, {b3, b4}, {e3, e4}, {f3, f4}, {i1, i2}, {i3, i4}, {j1, j2}, and {j3, j4}. The total number of spine links is twelve for this configuration. Across the spine link members, traffic is load balanced. For this part of the configuration, refer to the circles in [Figure 123: Spine Link Configuration](#).

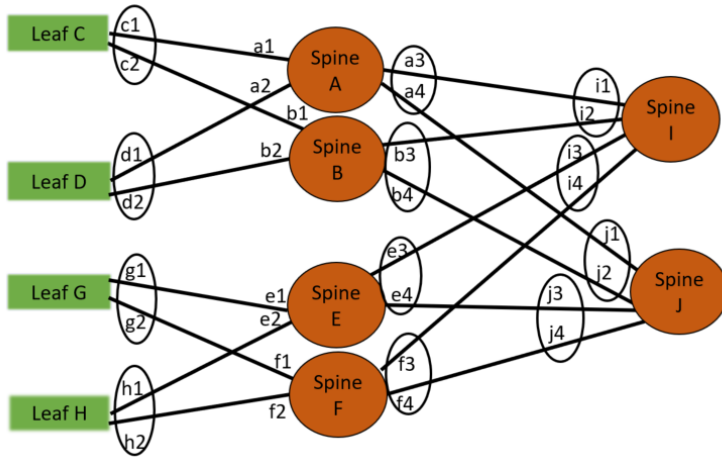


Figure 123: Spine Link Configuration

NOTE: You must not configure any spine links from spine nodes to leaf nodes. For example, in the [Figure 123: Spine Link Configuration](#), a1 and a2 should not be configured as spine links.

Configure Stack Links

The stack links are: {a1,c1}, {a2,d1}, {a3,i1}, {a4,j1}, {b1,c2}, {b2, d2}, {b3, i2}, {b4, j2}, {e1, g1}, {e2, h1}, {e3, i3}, {e4, j3}, {f1, g2}, {f2, h2}, {f3, i4}, {f4, j4}. The total number of stack links is sixteen for this configuration. For this part of the configuration, refer to the circles in [Figure 123: Spine Link Configuration](#).

These configuration steps ensure that the spine and leaf nodes are fully meshed.

Notes and Considerations

For the limitations and considerations, refer the Notes and Considerations in Page 8.

Configuration of Spine to Spine and Leaf Architecture

To configure Spine to Spine and Leaf Architecture, follow these steps:

1. Configure Leaf-Spine Cluster formation workflow. To configure, refer [Leaf-Spine Cluster Formation Workflow](#).
2. Execute the Gigamon Automation GigaVUE-FM SDK to establish the connection between the first level of spines and the second level of spines.
3. View the renewed topology in GigaVUE-FM, and reorder them if required.
4. Verify the configurations performed.

You can view the updated topology in GigaVUE-FM only after the execution of the Gigamon Automation GigaVUE-FM SDK to establish the connection between the first level and second level spines.

Limitations

- It is not recommended to have network and tool in one segment and GSOP in other segment. You must follow any one of the below arrangements:
 - Network and GSOP in one segment of the spine, and the tool in other segment of the spine.
 - Network in one segment of the spine, and GSOP and tool in other segment of the spine.
- If the network port is in first level spine of segment 1, then the leaf should be in the leaf of segment 2.
- If the network port is in first level spine of segment 2, then the leaf should be in the leaf of segment 1.

Leaf-Spine Cluster Deployment

This section describes the steps and prerequisites to deploy a leaf-spine cluster.

Refer to [Introduction to Spine to Spine and Leaf](#) for a conceptual overview of the leaf-spine architecture.

Deployment Checklist

Before forming a Leaf-Spine Cluster, it is strongly recommended that you get familiar with the relevant documentation and review the deployment checklist to prepare for deployment.

Documentation

- Review the **GigaVUE-FM Release Notes** to familiarize yourself with the functionality around creating and managing clusters.
- Review the "Multi-Path Leaf and Spine" chapter to familiarize yourself with leaf and spine architecture.

- Review the **GigaVUE-FM Release Notes** for any known issue that may impact your use case.

Pre-deployment checklist

- Gigamon Fabric Management must be upgraded to Gigamon 5.4.01 or later.
- Gigamon device must be upgraded to GigaVUE-OS 5.4.00 or later.
- Advanced Features License must be installed in TA devices.
- Physical connection must be established to create stack links.
- Devices must have GDP enabled and be physically connected to create links among devices from Gigamon.

IMPORTANT: Recommendation is to use TA devices as SPINE Nodes and other devices as LEAF Nodes.

Formation Scenario

The Spine to Spine and Leaf cluster is formed with different combinations of devices with Spine and Leaf nodes as a node cluster.

The following configuration creates a leaf-spine cluster with four leaves, four first level spines, and two second level spines.

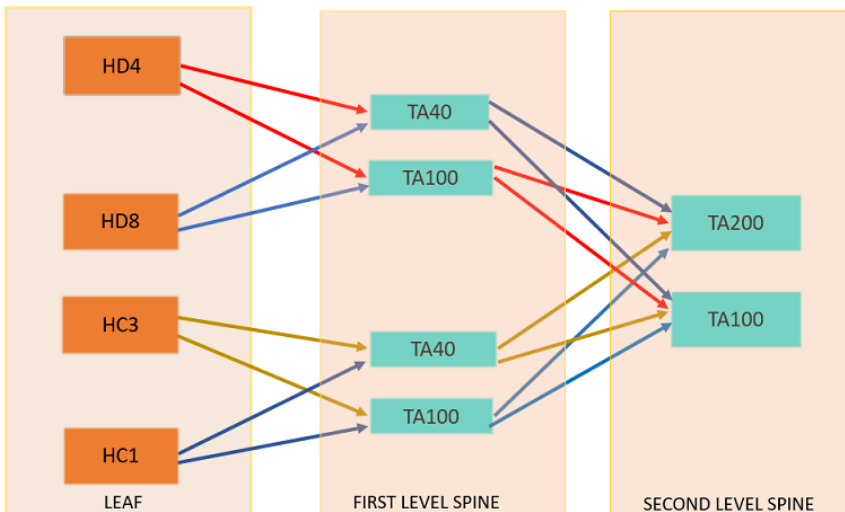


Figure 124: Spine to Spine and Leaf cluster overview,

NOTE: GigaStreams support different speeds, as indicated by the different colored connector lines in Figure 124: Spine to Spine and Leaf cluster overview, .

Work with GigaVUE HC TAP Modules

This chapter describes GigaVUE HC TAP modules on GigaVUE-HC2 and GigaVUE-HC1 nodes. Refer to the following sections for details:

- [Fiber TAPs](#)
- [Copper TAPs](#)
- [Best Practices When Working with GigaVUE Modules](#)

Fiber TAPs

The GigaVUE-HC2 node provides Internal TAP (Tapping Access Point) capabilities to passively copy optical traffic flowing between two external sources (typically switches, routers, and servers).

The fiber modules contains 24 fiber ports set up in pairs to allow bidirectional traffic to continue to flow between the original sources and destinations. Since there are 12 sets of port pairs, the modules provide for 12 TAPs. An internal optical splitter passively copies the traffic to the backplane at line speeds. Even in the event of a power loss in the chassis, traffic will continue to pass between the original source and destination.

Unlike an external TAP, an internal TAP has no external ports for the copied traffic; rather the traffic goes directly to the backplane of the unit. This maximizes TAP density. This also prevents unauthorized users from attaching a local packet capture device to capture and see the packets without permission. Thus, only users properly logged into the system gain access to sensitive information.

The GigaVUE-HC2 supports three fiber TAPs. TAPs can operate at 10Gb speed or 1Gb. This can be customized using the commands in [How to Set Port Speeds](#). Refer to the following:

- [TAP-HC0-D25AC0](#)
- [TAP-HC0-D25BC0](#)
- [TAP-HC0-D35CC0](#)
- [Fiber TAPs Considerations](#)
- [How to Set Port Speeds](#)

TAP-HC0-D25AC0

The TAP-HC0-D25AC0 module provides 12 SX/SR TAP connections to be used as network ports running over 50/125 μ multimode fiber. This module has 24 ports enabling 12 TAPs. Each port pair is arranged one above the other providing bidirectional traffic to flow between two nodes. Internally, a

splitter passively copies traffic for use with flow maps.

TAP-HC0-D25BC0

The TAP-HC0-D25BC0 module provides 12 SX/SR TAP connections to be used as network ports running over 62.5/125 μ multimode fiber. This modules also has 24 ports enabling 12 TAPs.

TAP-HC0-D35CC0

The TAP-HC0-D35CC0 module provides 12 LX/LR TAP connections to be used as network ports running over singlemode fiber. This module has 24 ports enabling 12 TAPs. Each port pair is arranged one above the other providing bidirectional traffic to flow between two nodes. Internally, a splitter passively copies traffic for use with flow maps.

Fiber TAPs Considerations

- Fiber TAP ports cannot participate in port-pair creation.
- Autonegotiation is always off and cannot be enabled.
- If using SX/LX TAP connections on both ends, the TAP speed should be set to 1000. If SR/LR TAP connections on both ends, the TAP speed should be set to 10000.

How to Set Port Speeds

To tap traffic passing through the TAP ports we need to enable the port and set the speed to match the end node's port speed. For instructions on how to enable the port and set the speed, refer to [Configure Ports](#).

Copper TAPs

TAP-HC0-G100C0 module on the GigaVUE-HC2 and the TAP-HC1-G10040 on the GigaVUE-HC1, provide the ability to tap a copper Gigabit Ethernet link, copying traffic to specified tool ports as it flows through the TAP. There are pairs of ports for tapping in to bidirectional link. The speed is set to 1Gb. You can configure the copper bypass module to receive traffic from SPAN port or external copper TAP.

Refer to the following:

- [Passive Mode vs. Active Mode](#)
- [Configure TAP Connections](#)
- [Configure Inline Bypass on TAP-HC0-G100C0 and TAP-HC1-G10040](#)

Passive Mode vs. Active Mode

By default, the ports in the TAP-HC0-G100C0 and the TAP-HC1-G10040 modules operate in **passive mode** instead of **active mode**:

- In **passive mode**, the relays in these TAP modules are closed. This means that traffic received on one port is passed through out the other port in the pair but is never seen by the GigaVUE – it simply flows between the two ports. The default is **passive mode**.

Passive mode protects production links in case of power failure. The TAP always reverts to passive mode in the event of a power loss.

NOTE: The Link and Activity LEDs are always off when the TAP-HC0-G100C0 or TAP-HC1-G10040 is operating in passive mode.

- In **active mode**, the relays in the TAP-HC0-G100C0 or TAP-HC1-G10040 module are open. Traffic received on one port is actively regenerated out the other port in the port-pair. In addition, traffic flows through the GigaVUE, making it available to tool ports.

Configure TAP Connections

You can configure the TAP-HC1-G10040 module in **active mode** and disable the port-pair to receive SPAN traffic.

There are two main configuration steps when tapping a link with the TAP-HC0-G100C0 or TAP-HC1-G10040:

- [Set up the Port-Pair](#)
- [Verify End Node Status and Open the Relays](#)
- [Set up Connections/Maps for Both Ports](#)

Set up the Port-Pair

A port-pair is a bidirectional connection in which traffic arriving on one port in the pair is actively regenerated out the other (and vice-versa) as a passthrough TAP. Without a port-pair in place, traffic arriving on one port will not be regenerated out the other. So, the first step in tapping a link is to set up the port-pair. For instructions on how to set up the port pair, refer to [Port Pairs](#).

NOTE: By default, the copper TAP ports on the TAP-HC0-G100C0 or TAP-HC1-G10040 module are set to a port type of **network**.

Notes on Port-Pairs

- Port-pairs cannot be established between any other ports on the same TAP-HC0-G100C0 or TAP-HC1-G10040 and another TAP-HC0-G100C0 or TAP-HC1-G10040 on the same chassis. Port-pairs can only be established between the same TAP pairs.
- Port-pairs support link status propagation – when one port goes down, the other port goes down (and vice-versa).

NOTE: A port-pair created on a copper TAP has Link Failure Propagation (LFP) enabled by default.

Verify End Node Status and Open the Relays

The next step is to open the relays for the ports used to tap the link. **Before doing so, however, check the link status LEDs on both end nodes connected to the port-pair ports to verify that they are operating correctly. The links must be good for failover protection to function properly.**

If the link status on the end nodes is not good (LEDs are not green), check the following:

- Verify that the combined cable length is less than 100 meters.
- Verify that autonegotiation settings match. Autonegotiation is always on and cannot be disabled.
- Most newer Ethernet interfaces support autosensing (Auto-MDI/MDI-X; part of the 1000BASE-T standard). However, if your equipment does not support this feature (or it is disabled), you may need to use a crossover cable.
- Open the relays for the ports used to tap the link in the TAP-HC0-G100C0 or TAP-HC1-G10040 using the **port <port-list> params taptx active** command, followed by a **write mem**. Once you have opened the relays, verify that the green link LEDs for both ports in the port-pair have illuminated.

Set up Connections/Maps for Both Ports

The configuration steps are as follows:

Step	Refer to...
Enable the required network ports, and then enable the Auto Negotiation on the 1Gb copper ports.	Configure Ports
Set up the port pair between the network ports that you enabled in the previous step	Port Pairs

Step	Refer to...
so that the traffic received on one port is repeated out the other (and vice-versa).	
Open the relays on both the ports.	

Once you have set up a port-pair, make sure to logically connect both ports in the port-pair maps to tool ports. Only the receive traffic is forwarded through the maps, so it is important to connect both sides of the port-pair to tool ports to see both sides of the traffic.

Configure Inline Bypass on TAP-HC0-G100C0 and TAP-HC1-G10040

Starting in software version 4.3, network ports on the copper TAP module, TAP-HC0-G100C0 on GigaVUE-HC2, can be configured through software to be inline network ports. This allows the TAP-HC0-G100C0 to act as a copper bypass module, providing protected inline networks for copper ports. The functionality is similar to that offered on bypass combo modules for fiber ports, which is described in [Configure Inline Bypass Solutions](#).

Starting in software version 4.8, the TAP-HC1-G10040 on the GigaVUE-HC1 is a copper bypass module, providing protected inline networks for copper ports.

Rules for Inline Bypass on TAP-HC0-G100C0 and TAP-HC1-G10040

The TAP-HC0-G100C0 module on the GigaVUE-HC2 features 12 pairs of relay-protected copper ports. The TAP-HC1-G10040 module on the GigaVUE-HC1 features 4 pairs of relay-protected copper ports.

The protected port pairs on these modules can operate either as a copper TAP or as an inline network. Because the port pairs can have a dual role, the following rules apply:

- If a given pair of protected copper ports on the TAP-HC0-G100C0 or TAP-HC1-G10040 is not used for TAP-type arrangements (there is no port-pair configured between the protected ports and there are no out-of-band maps), the ports of such a pair are available for assigning the port type inline-network and for configuring an inline network. This inline network will behave the same as any fiber-based protected inline networks offered by bypass combo modules on GigaVUE-HC2.
- If a given pair of protected copper ports on the TAP-HC0-G100C0 or TAP-HC1-G10040 is used for TAP-type arrangements (there is a port-pair configured between the protected ports and, optionally, there are out-of-band maps), the ports of such a pair are blocked from assigning the port type inline-network and from configuring an inline-network.

- If a given pair of protected copper ports on the TAP-HC0-G100C0 or TAP-HC1-G10040 is used for protected inline bypass arrangements (the ports are assigned the port type inline-network), the ports are blocked from configuring a port-pair.
- Assigning a port type (either network or inline-network) to ports of a protected copper pair always affects both ports of the pair.
- Configuring an inline network using ports on the TAP-HC0-G100C0 or TAP-HC1-G10040 must enforce proper pairing of the net-a and net-b attributes of the inline network. This means that the ports selected as net-a and net-b must belong to the same pair of copper TAP ports.

Best Practices When Working with GigaVUE Modules

IMPORTANT: When working with GigaVUE modules, it is generally best to use each module for its intended purpose:

- Use TAP ports to tap into network links.
- Use non-TAP ports on Copper TAPs for end station or SPAN port connections.

Fabric Statistics

This chapter provides the statistics of all types of ports available in GigaVUE H series and TA series.

Refer to the following sections for details:

- [About Fabric Statistics](#)
- [Display Fabric Statistics for All Ports](#)
- [Display Fabric Statistics for a Single Port](#)
- [Export Fabric Statistics](#)
- [Filter Fabric Statistics](#)

About Fabric Statistics

GigaVUE-FM provides the ability to view detailed information about the packets dropped, packets discarded, and packets received and transmitted by the following ports:

- Network ports
- Tool ports
- Hybrid ports
- Inline-network ports
- Inline-tool ports

- GigaSMART engine ports
- Backplane ports
- XAUII ports
- Stack ports

Network ports, tool ports, hybrid ports, inline-network ports, and inline-tool ports are also called front panel ports. These are the ports that are visible on the front view of the GigaVUE node.

The backplane ports on the control card are connected to the backplane ports on the line card or GigaSMART engine ports. They allow packets to move from card to card, for example, from line card to control card and control card to GigaSMART card. If there are packet errors in the backplane ports, this information can be viewed in the Fabric Statistics page. The format used to represent a backplane port is <box ID>/<slot ID>/<port ID>. For example, 1/1/s1 where s1 refers to port s1.

GigaVUE-FM also collects statistics of XAUII links on the GigaSMART engine ports. Each GigaSMART engine port is made up of 2 to 4 XAUII links, depending upon the platform. They are considered as the child ports of GigaSMART engine ports. The format used to represent a XAUII port is <box ID>/<slot ID>/<port ID>. For example, 1/5/e1x0 where e1x0 refers to the first XAUII port on engine 1.

Display Fabric Statistics for All Ports

Using the Fabric Statistics page, you can view the statistics associated with the port types. If there are packet drops in the ports, click on the port and drill down further to investigate the cause of the packet drops.

To view the Fabric Statistics page:

1. Click **Physical** in the top navigation bar.
2. In the Physical Nodes page, click on a GigaVUE node.
3. On the left navigation pane, select **Ports > Ports > Fabric Statistics**.

[Table 16: Fabric Statistics Definitions](#) describes the columns in the Fabric Statistics table.

Table 16: Fabric Statistics Definitions

Counter	Definition	Notes
Port ID	Port ID in the format <box id/slot id/port id>	
Alias	Alias of the port	
Unicast Packets Rx	Total unicast packets received	Excludes multicast packets, broadcast packets, packets with FCS/CRC errors, MTU exceeded errors, oversize packets, and pause packets.
Unicast Packets Tx	Total unicast packets transmitted	Excludes multicast packets, broadcast packets, packets with FCS/CRC errors, MTU exceeded errors, oversize packets, and pause packets.
Packets/sec Rx	Total packets received per second Excludes multicast packets, broadcast packets, packets with FCS/CRC errors, MTU exceeded errors, oversize packets, and pause packets.	Excludes packets with FCS/CRC errors.
Packets/sec Tx	Total packets transmitted per second	Excludes multicast packets, broadcast packets, packets with FCS/CRC errors, MTU exceeded errors, oversize packets, and pause packets.
Octets/sec Rx	Total bytes received per second This indicates the rate of incoming bytes in the last second.	
Octets/sec Tx	Total bytes transmitted per second This indicates the rate of incoming bytes in the last second.	
Utilization Rx	Percentage of port utilization by packets received	
Utilization Tx	Percentage of port utilization by packets transmitted	
Link Speed	Maximum link speed of the port	
Type	Type of port	
Octets Rx	Total bytes received Includes all valid and error frames with the exceptions noted in the adjacent columns.	Excludes undersize frames.
Octets Tx	Total bytes transmitted Includes all valid and error frames with the exceptions noted in the adjacent	Excludes undersize frames.

Counter	Definition	Notes
	columns.	
Non-unicast Packets Rx	Total Broadcast and Multicast packets received	
Non-unicast Packets Tx	Total Broadcast and Multicast packets transmitted	
Packet Drops Rx	Total received packets dropped	Packets are dropped when a tool port's bandwidth is exceeded due to oversubscription. Packets are dropped when they reach the tool port but before they are sent out.
Packet Drops Tx	Total transmitted packets dropped	Packets are dropped when a tool port's bandwidth is exceeded due to oversubscription. Packets are dropped when they reach the tool port but before they are sent out.
Discards Rx	Total received packets discarded	This counter increments when a packet is discarded at a tool port due to a tool port map rule.
Discards Tx	Total transmitted packets discarded	This counter increments when a packet is discarded at a tool port due to a tool port map rule.
	Total error packets received Error packets include undersize, FCS/CRC, MTU exceeded, fragments, and oversize packets.	Excludes oversize packets without FCS/CRC. Packets larger than the MTU setting arriving on a network port are counted twice in the counter. So 1000 oversize packets would show up as 2000. This double-counting only happens with Oversize error packets.
	Total error packets transmitted Error packets include undersize, FCS/CRC, MTU exceeded, fragments, and oversize packets.	Excludes oversize packets without FCS/CRC. Packets larger than the MTU setting arriving on a network port are counted twice in the counter. So 1000 oversize packets would show up as 2000. This double-counting only happens with Oversize error packets.

The port types in the Fabric Statistics table are represented as follows:

Table 17: Port Types

Port	Port Type
Network Port	N
Tool Port	T
Hybrid Port	H
Inline Network Port	iN

Port	Port Type
Inline Tool Port	iT
GigaSMART Engine Port	E (bigger size)
Backplane Port	BP
XAUII Port	E (smaller size)
Stack Port	S

Display Fabric Statistics for a Single Port

On the Fabric Statistics page, select any port (except for backplane and XAUII) and click anywhere in the row. The port quick view is displayed. The port quick view provides information about a specific port. Each field is color-coded in the graphical representation.

Port Quick View

The port quick view provides a graphical view of the port statistics. You can choose to view the statistics based on an hour, a day, a week, a month, or live to see the real-time data. The quick view also provides information about port properties, statistics about the traffic received (Rx) and transmitted (Tx), and alarms information. Click Counters drop-down list to select other options.

The following table describes the parameters displayed in the Port quick view:

Field	Description
Port Info	Displays the port information such as the name of the port, if any.
Parameters	Displays information about the current link status of the port, admin status, port type, port speed, port's duplex configuration, auto negotiation configuration, and the force link up configuration.
Transceiver	Displays the transceiver type connected to the port, optical input power, vendor from where the transceiver is purchased, product number, serial number, and temperature.
Filters	Displays the number of filters, pass rules, and drop rules applied to the port.
Alarms	Displays the buffer threshold percentage on the ports in the Rx and Tx directions, high and low utilization threshold percentage, and the port utilization in the Rx and Tx directions.
Permissions	Displays the roles and permissions associated with the port, users with permission to lock the port, and users to whom the port is shared.
Related Maps	Displays the related maps associated with the port.

Export Fabric Statistics

To export the fabric statistics, click **Export**. The statistics table is downloaded with a filename in the format Port_Stats_<yyyymmddhhmmss>; for example, Port_Stats_20161003172336.

Filter Fabric Statistics

Using filters, you can search and narrow down the ports displayed in the Fabric Statistics page. To filter the fabric statistics, click **Filter**. A filter quick view appears as shown in [Figure 125: Fabric Statistics Filter](#). Specify the criteria to filter the ports.

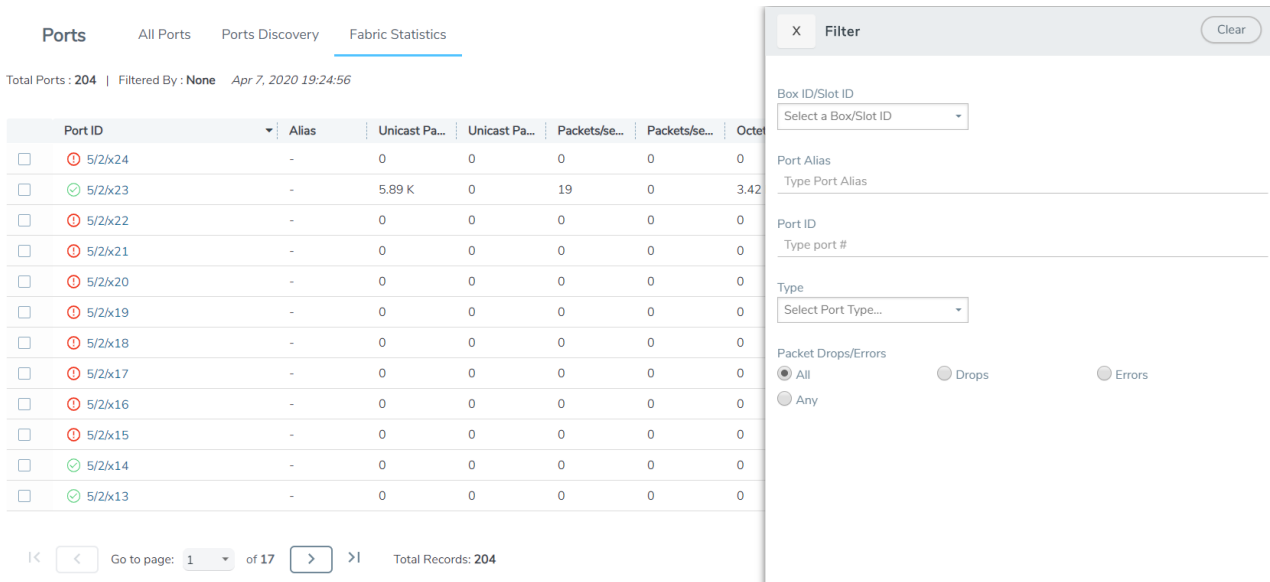


Figure 125: Fabric Statistics Filter

The criteria that you can use to filter the fabric statistics is as follows:

Criteria	Description
Box/Slot ID	Displays only those ports that match the specified box and slot IDs.
Port Alias	Displays a port with specified alias.
Port ID	Displays ports with specified port ID. For example, if you specify 3 as the port ID, the result will display ports that include the number 3, 13, 23, 30, and so on.
Type	Displays ports with specified port type. Select one of the following: <ul style="list-style-type: none"> • Network • Tool

Criteria	Description
	<ul style="list-style-type: none"> • Inline Network • Inline Tool • GigaSMART • Hybrid • Stack • Backplane • XAUII
Packet Drops/Errors	<p>Displays only those ports with packet drops or errors or both. Select one of the following:</p> <ul style="list-style-type: none"> • All — displays ports with both packet drops and errors. This is the default. • Drops — displays ports with only packet drops. • Errors — displays ports with only packet errors. • Any — displays ports with either packet drops or packet errors.

Topology Visualization

This section describes the Topology view available in GigaVUE-FM. The Topology view displays the nodes and clusters managed by GigaVUE-FM.

This chapter covers the following topics.

- [Overview of Topology](#)
- [Table View](#)
- [How to Customize Topology](#)
- [Export and Import Topology](#)
- [FabricVUE Topology Views](#)

Overview of Topology

Topology shows all the physical nodes and clusters that are discoverable.

The GigaVUE H Series and TA Series nodes are capable of snooping Link Layer Discovery Protocol (LLDP) packets and Cisco Discovery Protocol (CDP) packets. Starting in GigaVUE-FM 5.2, they are also capable of sending Gigamon Discovery packets.

GigaVUE nodes receive LLDP and CDP packets from non Gigamon devices. They receive Gigamon Discovery packets from GigaVUE nodes managed by GigaVUE-FM.

If the nodes in your network use either of these protocols, they can identify its immediate neighbors and their capabilities. The LLDP, CDP, and Gigamon discovery information includes the remote port and chassis IDs, as well as other selected information, if it is included by the sender. This information can be used to determine the origin of traffic flows.

All these protocols are physical topology discovery protocols (Layer 2). LLDP and CDP are unidirectional. Devices send their identity and capabilities in a packet. The node receives the packet and extracts information from it, such as the chassis ID and port ID of a neighbor. The information from the neighbors varies depending on what is sent in the packet.

Gigamon discovery is bidirectional. GigaVUE nodes transmit the LLDP packets with a unique type-length-value (TLV) structure that is identifiable by another GigaVUE node. When a GigaVUE node receives these packets, it detects the TLV structure and identifies the discovered node as a GigaVUE node. These Gigamon discovery packets also include the management IP4 and IP6 address of the node in the unique TLV structure. Using the management IP address, the neighbor information of the discovered nodes is collected to build the entire physical topology.

The Gigamon discovery packets can be transmitted out of tool, stack, network, and hybrid port types. For stack port types, Gigamon Discovery works only when both ends of the link are of type stack.

The hybrid ports and ports configured with force link up are operated in loopback mode. So, when Gigamon discovery is enabled, these ports show themselves as neighbors.

The Gigamon discovery packets are transmitted as soon as the link is up on the relevant port. They are retransmitted when changes are made to the port or chassis configuration such as the host name on the box, port type, IP address of the management interface, and so on. When the transmission or retransmission of Gigamon discovery packets begins, the interpacket time intervals per port is 1, 2, 4, 8, 16, 30, 30, 30, seconds. The packets are transmitted every 30 seconds so that the nodes are discovered as soon as possible. Discovery packets are terminated on the receiving GigaVUE node.

GigaVUE-FM constructs the topology by doing the following:

- Groups discovered nodes into clusters by combining nodes with the same cluster ID.
- Queries the master node for the existing stack links.
- Extracts the box IDs from the connected nodes.

- For port-based stack links, the box ID is extracted from the interconnected stack port IDs.
- For GigaStream-based stack links, the box ID is extracted from the first port member of each GigaStream.

Topology construction has the following limitations:

- GigaVUE-FM relies on the cluster configuration to construct the topology.
 - Cascading nodes interconnected over network or tool ports or over Port Groups or GigaStream (other than stack links) are not discovered.
 - GigaVUE-FM does not detect miswired cluster cabling.
 - If GigaVUE H and TA Series nodes connected over tool ports are not managed by GigaVUE-FM, then they are not automatically discovered.
- GigaVUE-FM constructs H Series cluster topology by querying nodes for the relevant connectivity information. The topology is constructed based on information from the GigaVUE nodes.
- Gigamon discovery is not supported on inline-tool and inline-network port type.
- For stack ports, Gigamon discovery will work only if both ends of the link are of type stack.
- If a pass-all map is configured for Gigamon discovery enabled ports, the show map statistics will show an increment in the map rule counter for Gigamon discovery packets although the Gigamon discovery packets are not sent to the tool ports.
- If Gigamon discovery is enabled on a port, for example port 9/3/x1, and the port type is changed to an unsupported port types such as inline-network, Gigamon discovery is immediately disabled and an error message is displayed.

Notes:

- Prior to GigaVUE-OS version 4.7, GigaVUE TA Series Traffic Aggregator nodes did not support tool ports. Instead, they supported gateway ports. Starting in GigaVUE-OS version 4.7, all gateway ports on GigaVUE TA Series nodes are tool ports. However, GigaVUE-FM may be managing nodes running a software version lower than version 4.7.
- G-Series nodes are not supported in Topology Visualization.

Enable Discovery Protocols

This section describes the following details:

- [Enable Gigamon Discovery on Chassis](#)
- [Enable LLDP, CDP, and Gigamon Discovery on Ports](#)

Enable Gigamon Discovery on Chassis

Gigamon discovery is disabled on chassis and ports. The Gigamon discovery packets are transmitted only when Gigamon Discovery is enabled on chassis as well ports.

To enable Gigamon discovery on chassis:

1. Click **Physical** on the top navigation bar.
2. In the left navigation pane, click **Physical Nodes**.
3. Click on a node on which you want to enable Gigamon Discovery. The Overview page of the node is displayed.
4. In the left navigation pane, click **Chassis**.
5. Switch the Chassis view to List View.
6. Under Cards, find the line card on which you want to enable Gigamon Discovery and select the card.
7. Click **Actions** and select **Enable Gigamon Discovery**.

The Enabled option is displayed under Gigamon Discovery for the selected Chassis ID.

Box ID 3 - GigaVUE-HD4											
Box: ID 3 - GigaVUE-HD4											
▼ Properties											
Chassis Id	Hardware Type	Mode	Gigamon Discovery	Hardware Revision	Product Code	Serial Number					
<input checked="" type="checkbox"/>	40011	HD4-Chassis	default	Enabled	AA	132-00A2	40011				
▼ Cards											
Slot Id	Hardware Type	Configured	Health Status	Operation Status	Fabric Hash	Filter Template	Hardware Revision	Product Code	Serial Number		
<input checked="" type="checkbox"/>	1	GigaPORT-X12G04	✓	●	●	N/A	None	D5-a6	132-0045	1450-1396	

Figure 126: Gigamon Discovery Enabled

Enable LLDP and CDP on Chassis

You can choose to enable LLDP and CDP on the management interface of a GigaVUE H Series or GigaVUE TA Series device. This will allow the device to discover neighboring devices in a network.

To enable LLDP and CDP on the management interface of a device:

1. On the top navigation bar, click **Physical**.
2. Click on a node on which you want to enable LLDP and CDP. The Overview page of the node appears.
3. In the left navigation pane, select **Settings > Interface > Protocol Configuration**.
4. Select the box ID on which you want to enable LLDP and CDP, and then click **Edit**.
5. Select the **Port Discovery** check box, and then select one of the following: **All**, **LLDP**, or **CDP**.
6. Click **Save**. The selected discovery protocol is enabled on the management interface of the device.

Enable LLDP, CDP, and Gigamon Discovery on Ports

To enable LLDP, CDP, and Gigamon Discovery on ports:

1. Click **Physical** on the top navigation bar.
2. In the left navigation pane, click **Physical Nodes**.
3. Click on a node on which you want to enable LLDP and CDP. The Overview page of the node appears.
4. In the left navigation pane, select **Ports > All Ports**.
5. On the Ports page, select the Port ID on which you want to enable LLDP, CDP, and Gigamon Discovery. Click **Edit**.
6. Under **Ports Discovery**, do the following:
 - a. To enable network discovery, select the **Enable** check box for Network Discovery.
 - b. To enable discovery protocols, select one of the following: **All**, **LLDP**, or **CDP**.
 - c. To enable Gigamon discovery, select the **Enable** check box for Gigamon Discovery.
7. Click **OK**.
8. Click **Save**.
9. Click the **Ports Discovery** tab. For each port on which the ports discovery is enabled, the neighbor information is displayed.

Limitations of Gigamon Discovery

Following are the limitations of Gigamon discovery:

- Gigamon discovery is not supported on inline-tool and inline-network port type.
- For stack ports, Gigamon discovery will work only if both ends of the link are of type stack.
- If a pass-all map is configured for Gigamon discovery enabled ports, the show map stats command will show an increment in the map rule counter for Gigamon discovery packets although the Gigamon discovery packets are not sent to the tool ports.

- If Gigamon discovery is enabled on a port, for example port 9/3/x1, and the port type is changed to an unsupported port types such as inline-network, Gigamon discovery is immediately disabled and the following message is displayed:
(config) # ! GDP is not supported with port type inline-network. Disabling gdp on port 9/3/x1
Similarly, if the port type is changed to inline-tool, the following message is displayed:
(config) # ! GDP is not supported with port type inline-too. Disabling gdp on port 9/3/x1
- The hybrid ports, tool-mirror source ports, and ports configured with force link up are operated in loopback mode. So, when Gigamon discovery is enabled, these port show themselves as neighbors.

View Clusters and Nodes in the Topology

To see the clusters and nodes managed by GigaVUE-FM, click **Physical** on the top navigation bar and then click **Topology** in the left navigation pane. The Gigamon nodes and other devices are represented by graphical icons. Connections between the nodes are represented by lines. Clusters appear as orange containers. Devices can be either discovered or manually added to the topology. [Figure 127: GigaVUE-FM Topology](#) shows an example star topology with three Gigamon clusters, Gigamon nodes, and other devices.

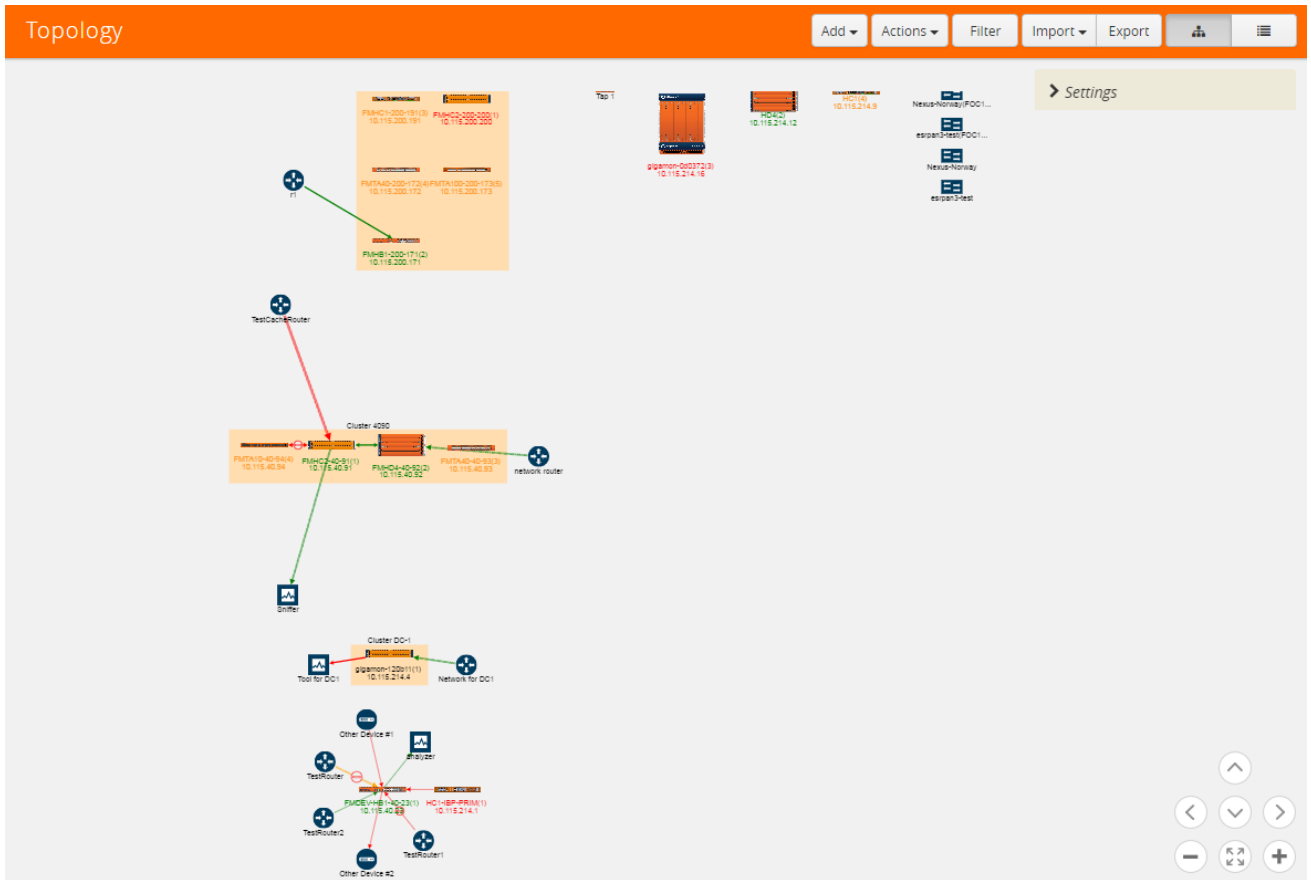


Figure 127: GigaVUE-FM Topology

Figure 127: GigaVUE-FM Topology shows an example of leaf and spine topology.

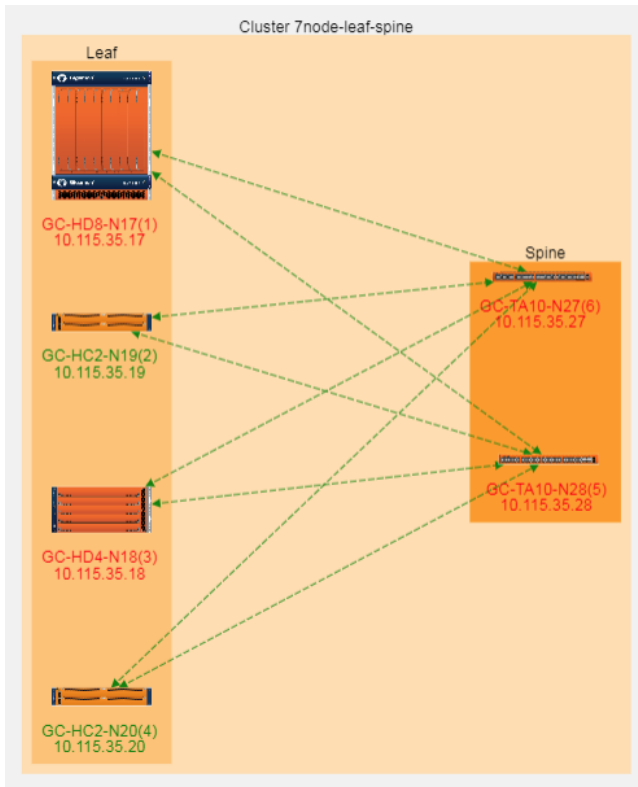


Figure 128: Leaf and Spine Topology

There are two kinds of nodes displayed in the leaf and spine topology, as follows:

- Leaf nodes, which are edge nodes and can also have TAPs or tools attached to them. All the leaf nodes are displayed within the Leaf container.
- Spine nodes, which are the nodes to which the leaf nodes attach. All the spine nodes are displayed within the Spine container.

The leaf and spine configuration can be done only by using the CLI commands. For more information about multi-path leaf and spine architecture and configuration, refer to *GigaVUE-OS-CLI Reference Guide* on the [Gigamon Customer Portal](#).

The Topology page has the following menus and buttons:

Menu/Button	Description
Add	The Add menu has the following options: <ul style="list-style-type: none"> • Add Device(s)—opens an Add Device(s) page for selecting and manually adding nodes to the topology. For details, refer to Add Devices

Menu/Button	Description
	<ul style="list-style-type: none"> • Add Link(s)—opens an Add Link(s) page for adding links between nodes. For details, refer to Add Links • Add Tap—opens an Add Tap page for adding Gigamon TAPs to the topology. For details, refer to Add TAP.
Actions	<p>The Actions menu has the following options:</p> <ul style="list-style-type: none"> • Edit—opens the Edit page for a manually added node or link. The node or link must be selected for this option to be available. • Delete—deletes a manually added node or link. • Delete All—deletes all manually added nodes and links. • Reset Alignment—resets the alignment of clusters and nodes to the default alignment. • View Node Topology—shows the topology of a selected node. • Go to Node Overview—open the Overview page for the selected node.
Filter	<p>The Filter button opens a Quick View for selecting filter criteria for the topology. The filter makes it possible to select only those items that you want to view in the topology, such as nodes of a certain type or specific models of Gigamon nodes.</p>
Import	<p>The Import menu supports the importing of custom nodes and links from an Excel spread sheet. For details, refer to Export and Import Topology.</p>
Export	<p>The Export menu supports the exporting of custom nodes and links to an Excel spread sheet. For details, refer to Export and Import Topology.</p>
Topology View	<p>The Topology View button switches the Topology view to the graphic representation of Gigamon nodes, links, and the various types of nodes. Topology is the default view.</p>
Table View	<p>The Table View button switches the view to a table that lists all the items in the topology. For details about Table View, refer to Table View.</p>

The controls in the lower right-hand corner are used to move the topology up, down, left, right, and to zoom in or out. Clicking the center button makes a *best fit* of the topology on the page.

A context menu is available for clusters and nodes that includes options for realigning elements. Right-click on a cluster or a node to open the context menu, which stays open until you click elsewhere on the page. The options are as follows:

Menu Option	Description
View Node Topology	Opens the Node Topology page for the selected cluster or node. For more information about Node Topology, refer to Node Topology . You can also open the Node Topology by selecting Physical Nodes in the top Navigation pane, selecting the node or cluster, and then selecting Node Topology.
Go to Node Overview	Opens the Overview page for the selected node. You can also open the Overview page for the node by selecting Physical Nodes in the Navigation pane, and then selecting the node or cluster.
Align Neighbor	Aligns all the neighbors of the selected node or cluster. For details, refer to Align Neighbors .
Align Leaf Neighbor	Aligns only the immediate neighbors of the selected node or cluster. For details, refer to Align Leaf Neighbor .
Align Cluster	Aligns the nodes within a cluster container. For clusters with leaf and spine configuration, the leaf and spine nodes are aligned within their respective containers. For details, refer to Align Cluster .
Select Neighbor	Selects the cluster container or node and all of its immediate neighbors. The node or clusters and its neighbors can be moved as a unit. For details, refer to Select Neighbor .

Filter

Clicking the Filter button opens a Filter quick view. For topologies with large numbers of elements, the filter is useful for displaying only those items of immediate interest. The Filter quick view has the following options:

Filter Option	Description
Discovery	<p>Display discovered nodes by selecting one or more of the following (all are selected by default):</p> <ul style="list-style-type: none"> • Gigamon—displays Gigamon nodes • Manual—displays manually added nodes • CDP/LLDP—displays nodes discovered through CDP or LLDP <div style="border: 1px solid #ccc; padding: 5px; margin: 5px 0;"> <p>NOTE: If both CDP and LLDP packets are discovered on the same port, the topology construction relies on LLDP packets over CDP.</p> </div> <ul style="list-style-type: none"> • Taps—display TAPs
Device Types	Display only nodes of the selected type, such as router, switch, virtual switch, load balance, and so on. You can select more than one type.

Filter Option	Description
Vendor	Display manually added nodes that are from the specified vendor. Enter the vendor's name in the Vendor field.
Models	Display only the specified Gigamon model. You can select more than one model.
Cluster IDs	Display the clusters or nodes with the specified IDs. The drop-down list displays the IDs of the clusters and nodes in the topology. You can select more than one node or cluster.
Node Status	Display nodes with the specified status. The possible statuses are OK, Error, and Warning.

In [Figure 129: Filter on Cluster IDs in Topology](#), all Discovery filters are selected and two clusters are specified in the **Cluster ID(s)** field. Only items that meet the filter criteria are displayed while all other elements are grayed out.

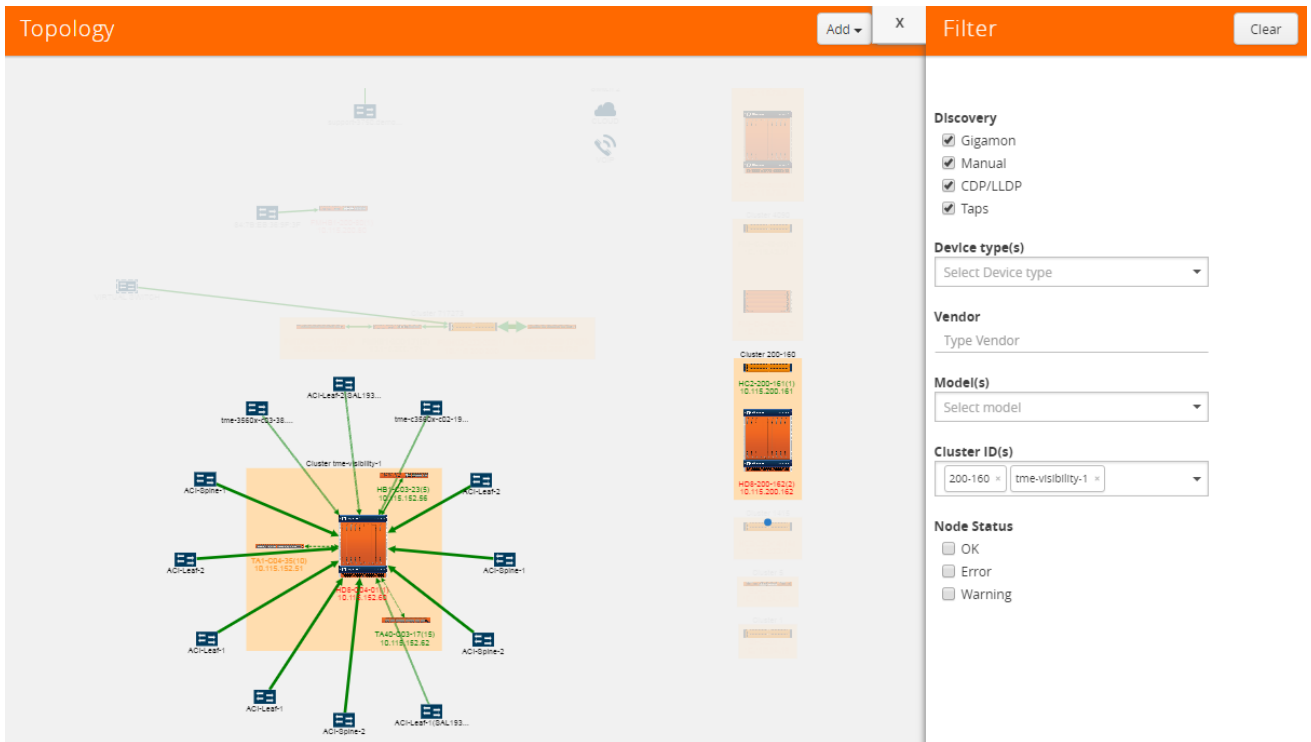


Figure 129: Filter on Cluster IDs in Topology

Links

Links between nodes are shown as arrows between nodes. The links are automatically created for nodes in clusters and connections to discovered neighbor nodes. The links are also discovered through LLDP, CDP, or Gigamon Discovery. The LLDP links represent a Gigamon-to-LLDP connection. The CDP links represent a Gigamon-to-CDP connection. The Gigamon Discovery links represent a

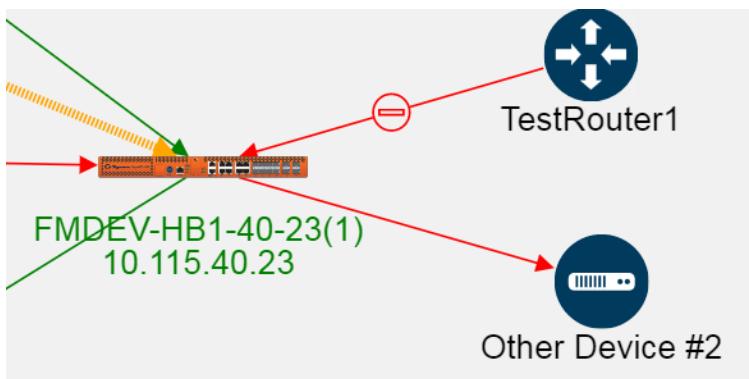
Gigamon-to-Gigamon connection. The thickness of the link indicates the link's bandwidth. A dashed line represents an aggregated link. Inside a cluster container, a dashed line represents a GigaStream stack link between nodes and the tool-tip for the link will provide information about the GigaStream. For more information about link aggregation, refer to [Aggregated Links](#).

Link State

Links between nodes in the topology have a color to indicate the link's current state. The link state is also identified in the tooltip information that displays when clicking on a link. The following are the link state colors and their meanings:

Color	Link State
Green	Up (connected)
Red	Down (disconnected), unreachable, or unknown The link state will be Red (or down) in an aggregated link if all the link states of the associated links of the aggregated link are down. In an aggregated link, the link state is unknown if all the link states of the associated links in the aggregated link are unknown.
Amber	Warning This link state only applies to aggregated links. If any one of the links in the aggregated link is down or unknown, the link state is rendered as amber.

Red indicates that the link is either down or its status is unreachable. When the link is down, a stop icon also displays on the link. For example, in the following figure, the link color (red) and the stop icon on the link from TestRouter1 to the GigaVUE-HB1 indicates that it is down. The link from the GigaVUE-HB1 to Other Device #2 is unknown because it is red and there is no icon on the link.



When the link status is between two Gigamon nodes, the link status is determined as follows:

- If the port for the link associated with the node is up, the link status is up or connected (green).

- If the port for the link associated with the node is down or unknown, the link status is down or disconnected (red) and a stop icon is displays on the link. However, if there is no stop icon, the status is unknown.

When the link is between a Gigamon node and an LLDP, CDP neighbor, another GigaVUE node, or a manually created node, the link status is determined by the link status of the Gigamon node as follows:

- If the port status is up, the link status is connected (green).
- If the port status is down or unknown, the link status is disconnected (red).

Link Health State

In addition to a link state, links have a health state based on link utilization. The link's health state is computed only when the link state is up. The health status is indicated in the tooltip when clicking on a link, which shows an LED bubble. The colors indicated the following

Color	Link Health State
Green	Normal utilization.
Red	The link is either underutilized or overutilized
Amber	At least one of the links in an aggregated link is either underutilized or overutilized.
Gray	Health state is not available.

If the health state of the link is not within the normal range of utilization based on the low and high utilization thresholds, a warning icon displays on the link.

Link Utilization Thresholds

The health state of a link is based on the utilization of the link. The utilization thresholds are specified through the settings dialog. The threshold values apply to all nodes managed by GigaVUE-FM. They should not be confused with port level thresholds.

To open the dialog, click **Settings** in the upper-right corner of the topology.

The Link Utilization Thresholds are as follows:

- **Low**—sets the lower limit of the utilization threshold. If the link's utilization falls below the specified percentage, the link is considered underutilized. The default is 40 percent utilization for a low utilization threshold.
- **High**—sets the upper limit of the utilization threshold. If the link's utilization rises above the specified percentage, the link is considered overutilized. The default is 75 percent utilization for a high utilization threshold.

- **Interval**—the time period (in minutes) over which the link utilization is measured. The time interval is used to determine utilization based on an average value of port utilization over the specified interval. The default is 15 minutes.
- **Utilization Overlay**—Turns on/off the utilization warning icons. An icons appear on the link if it is either overutilized or underutilized. To turn on the overlay, slide the switch to **on** and click **OK**. [Figure 130: Overutilization Overlay](#) shows an example where the utilization overlay is turned on. The Utilization Overlay setting only applies to the current session. If you log out of GigaVUE-FM and then log in again, the Utilization Overlay is set to **off**.

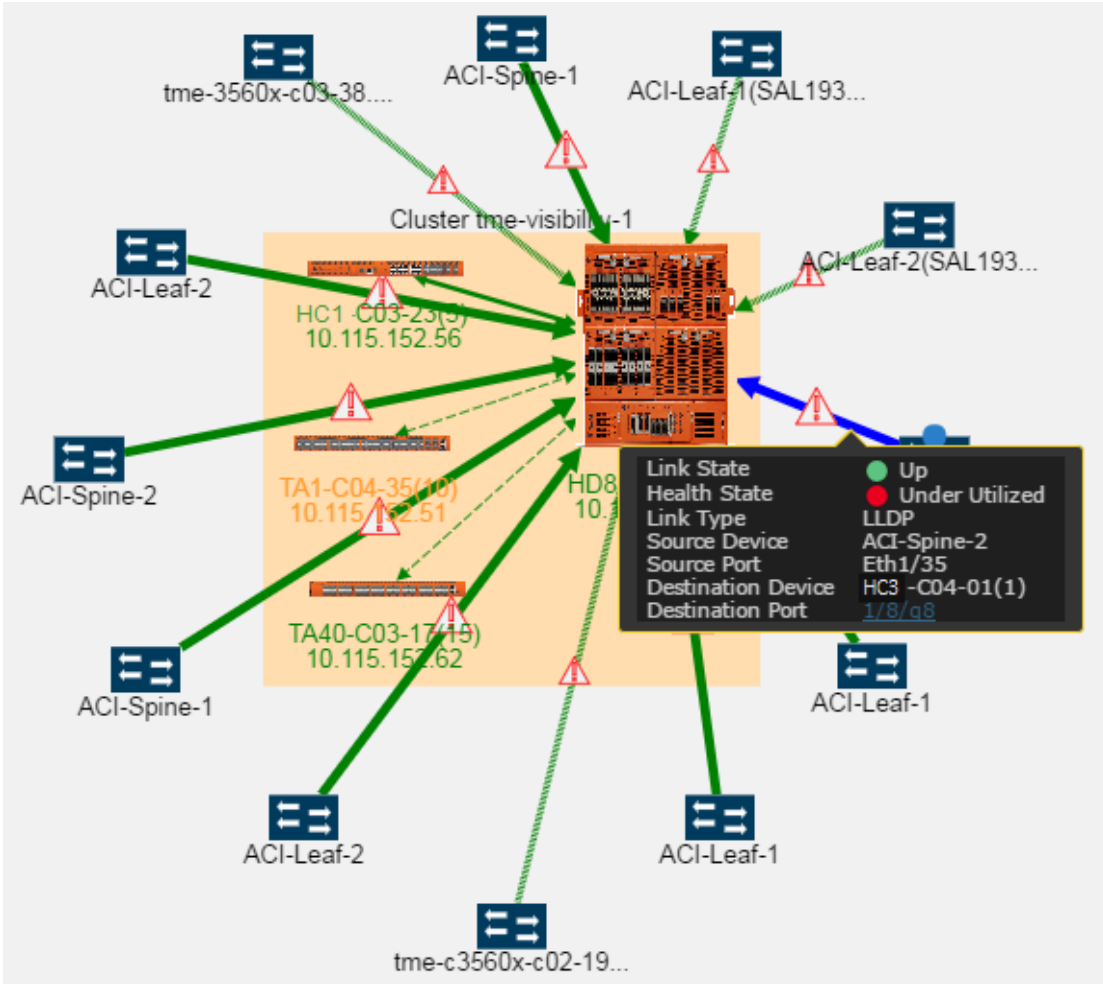


Figure 130: Overutilization Overlay

Aggregated Links

A node in the topology can have more than one link to another node. However, these links display in the topology as a single dashed line. In [Figure 131: Aggregated Link](#), the link between the node tme-c3560x-c02-19 and the GigaVUE-HD8 node in the cluster is an aggregated link. The link state or link health state of the links within the aggregation determine the state of the aggregated link. For more information, refer to [Link State](#) and [Link Health State](#).

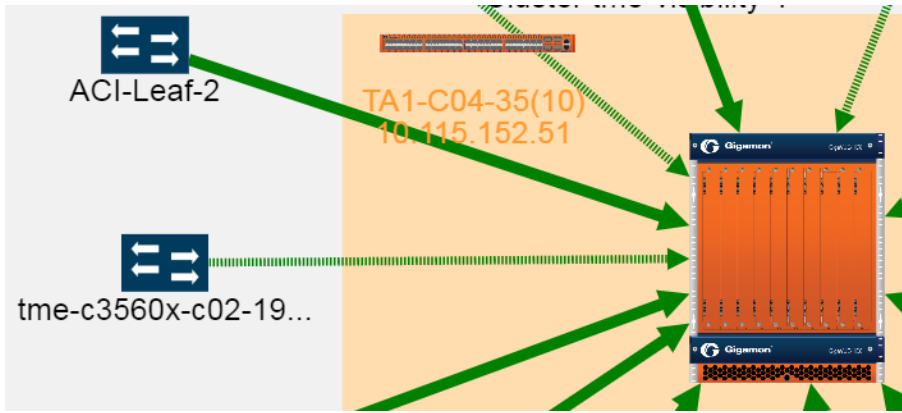


Figure 131: Aggregated Link

To view the links in the aggregation, right-click in the cluster container to open the context menu and select **View Node Topology**. Refer to [Figure 132: View Node Topology Selected](#).

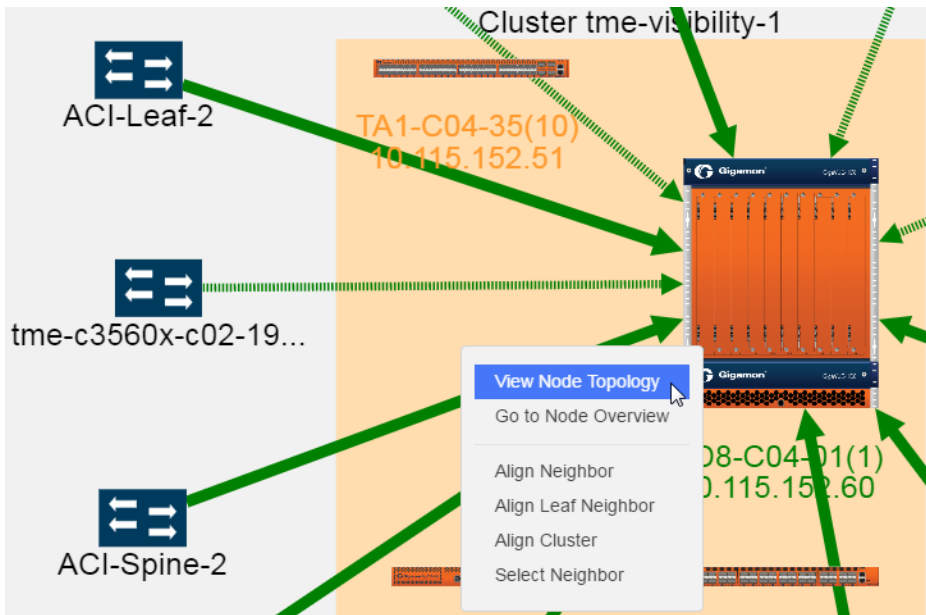


Figure 132: View Node Topology Selected

Selecting View Node Topology, opens the Node Topology for the selected cluster, where the links are not aggregated. [Figure 133: Node Topology](#) shows the cluster in [Figure 132: View Node Topology Selected](#) as it appears in Node Topology with all the links unaggregated. For more information about Node Topology, refer to [Node Topology](#).

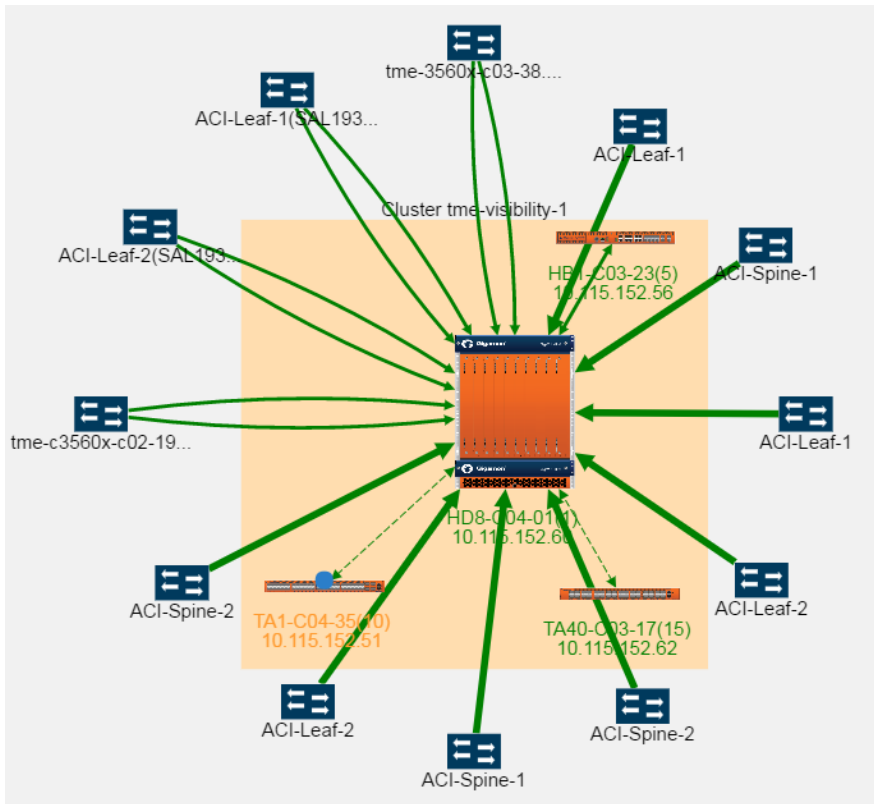


Figure 133: Node Topology

To return to the GigaVUE-FM Topology page, right-click on the cluster or node to open the context menu and select **View FM Topology**.

GigaStream

GigaStream links display in the topology as dashed lines within a cluster. Clicking on the link opens a tooltip that provides the source and destination GigaStream of the link. [Figure 134: Tooltip for a GigaStream](#) shows an example.

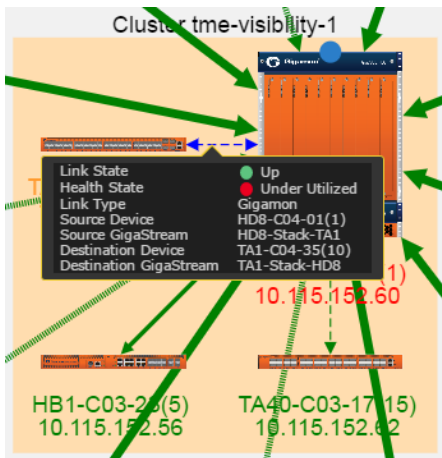


Figure 134: Tooltip for a GigaStream

Link Details

To view details about a link, click on the link and select **More Details** from the context menu. A Link Details quick view opens with details about the link. If the link is aggregated, Link Details shows information for each link in the aggregation. [Figure 135: Link Details for an Aggregated Link](#) shows the Link Details for an aggregated link with two links.

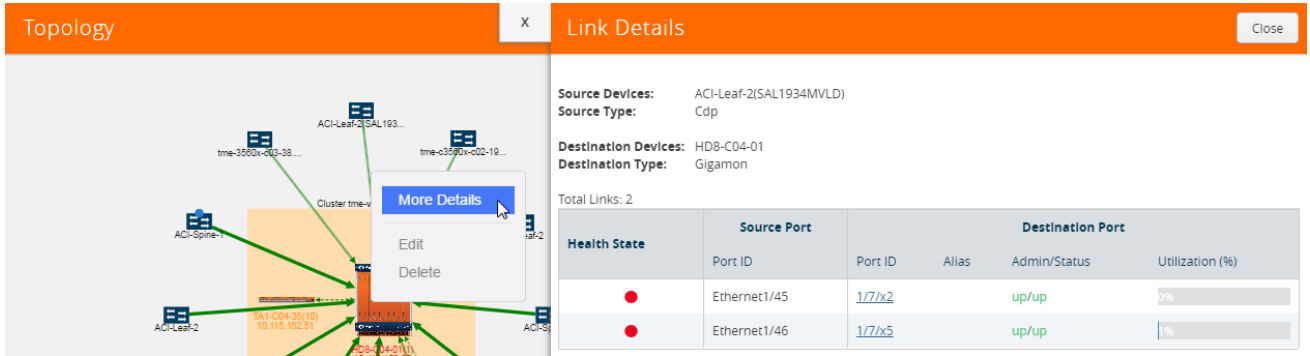


Figure 135: Link Details for an Aggregated Link

Link Details provides the following information:

Field	Description
Source Devices	The source nodes for the link.
Source Type	The type of source node: CDP, LLDP, Gigamon, or Manual
Destination Devices	The destination nodes for the link.
Destination Type	The type of destination node: CDP, LLDP, Gigamon, or Manual.
Total Links	Total number of links in the aggregation.
Health State	An LED bubble indicates the current health state of the port. Hovering over the bubble displays a tooltip with the current state of the link. For a description of the health states, refer to Link Health State .
Source Port	The details for the source port, such as the port ID of the link's source port. The exact details vary depending on the type of node.
Destination Port	The details for the destination port, such as the port ID of the link's destination port, alias (if any), admin and link status of the port, and the percentage of utilization displayed as a progress bar. The exact details vary depending on the type of node.

GigaStream Stack Link Details

If the link is a GigaStream stack link connecting a leaf and a spine node, Stack Link quick view is displayed. The quick view provides stack link information and GigaStream status with details such as GigaStream alias and total number of ports.

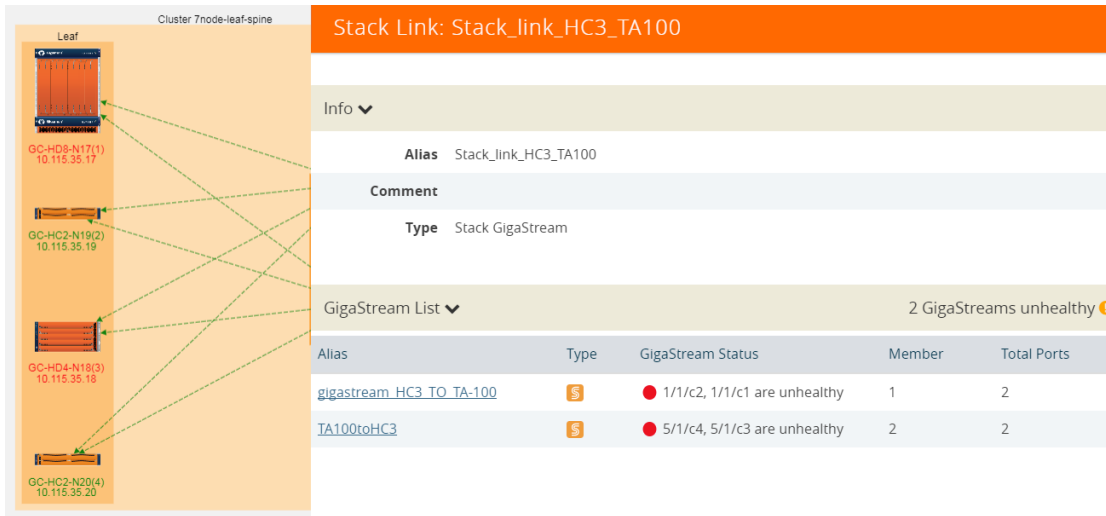


Figure 136: Link Details for a Stack Link

The following table describes the parameters displayed in the GigaStream stack link quick-view:

Field	Description
Info	Displays the stack link information such as the name of the stack link, component, and type.
GigaStream List	
Alias	Displays the stack GigaStream name.
Type	Displays the type of the port.
GigaStream Status	Displays the status.
Member	Displays the ranking of the GigaStream member in the stack GigaStream link. The number '1' represents the first GigaStream member configured. The number '2' represents the second GigaStream member configured.
Details	Displays the health status of the stack link.
Total Ports	Displays the total number of ports that connects the nodes.

Discovered Devices

Discovered nodes are displayed in gray containers when there are multiple neighbors. However, only one node displays in the container. The actual number of neighbor nodes is displayed in a label above the container and **More...** displays inside the container. Clicking on the container displays additional information. [Figure 137: Discovered Devices](#) shows a neighbor node container with seven discovered nodes that are neighbors to port 1/4/x3 on the node SHC2C.



Figure 137: Discovered Devices

Discovered nodes, including CDP, LLDP, and Gigamon discovery, display in the topology as switch icons. To determine the discovery type, click on the node icon to display a tooltip that provides information about the node. The Discovered Type field will show whether the node was discovered through CDP, LLDP, or Gigamon Discovery. If both CDP and LLDP packets are discovered on the same port, the topology construction relies on LLDP packets over CDP. In [Figure 138: Tooltip for a Discovered Device](#) the selected node shows tooltip that indicates that the node was discovered through LLDP.

NOTE: If the link represents a link to a SPAN port, the link does not display a context menus when clicked.

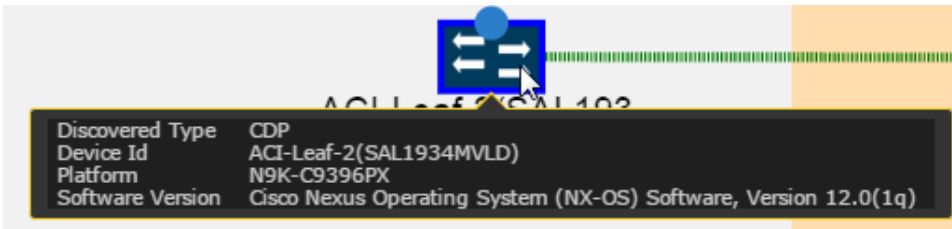


Figure 138: Tooltip for a Discovered Device

To view more information about discovered nodes in a discovered node container, click **More**. This opens a quick view that shows the information about the neighbor nodes. [Figure 139: Discovered Device Quick View](#) shows the quick view for the neighbor node container shown in [Figure 137: Discovered Devices](#).

Discovered Devices/Ports on SHC2C (1) Port 1/4/x3

Source Device	Source Port	Source Type	Destination Device	Destination Port	Destination Type
HQ-L3SW01-2	GigabitEthernet0/6	cdp	10.115.94.16	1/4/x3	gigamon
HQ-L3SW01-2	GigabitEthernet0/9	cdp	10.115.94.16	1/4/x3	gigamon
HQ-VL10-2	GigabitEthernet0/45	cdp	10.115.94.16	1/4/x3	gigamon
Core02-1	GigabitEthernet1/2/3	cdp	10.115.94.16	1/4/x3	gigamon
HQ-VL10-1	GigabitEthernet0/47	cdp	10.115.94.16	1/4/x3	gigamon
HQ-WiFi-VL40-8	GigabitEthernet1/0/48	cdp	10.115.94.16	1/4/x3	gigamon
Core02-1	GigabitEthernet2/2/3	cdp	10.115.94.16	1/4/x3	gigamon
HQ-L3SW01-2	GigabitEthernet0/10	cdp	10.115.94.16	1/4/x3	gigamon
HQ-L3SW01-2	GigabitEthernet0/1	cdp	10.115.94.16	1/4/x3	gigamon
HQ-VL10-1	GigabitEthernet0/48	cdp	10.115.94.16	1/4/x3	gigamon
HQ-VL10-1	GigabitEthernet0/46	cdp	10.115.94.16	1/4/x3	gigamon
HQ-WiFi-DMZ	GigabitEthernet1/0/1	cdp	10.115.94.16	1/4/x3	gigamon
HQ-VL10-2	GigabitEthernet0/48	cdp	10.115.94.16	1/4/x3	gigamon
HQ-VL10-1	GigabitEthernet0/45	cdp	10.115.94.16	1/4/x3	gigamon
HQ-L3SW01-2	GigabitEthernet0/5	cdp	10.115.94.16	1/4/x3	gigamon
HQES02(SSI14291AGZ)	Ethernet1/40	cdp	10.115.94.16	1/4/x3	gigamon
HQ-WiFi-VL40-8	GigabitEthernet1/0/47	cdp	10.115.94.16	1/4/x3	gigamon
HQ-VL10-2	GigabitEthernet0/46	cdp	10.115.94.16	1/4/x3	gigamon
HQ-VL10-2	GigabitEthernet0/47	cdp	10.115.94.16	1/4/x3	gigamon

Figure 139: Discovered Device Quick View

The container label indicates that there are seven neighbor nodes. However, the quick view lists more than seven nodes. This is because discovery is based on the connections between ports and a port may be connected to more than one node, resulting in the node being listed more than once in the quick view.

Table View

The default view is Topology Visualization. You can switch to Table View by clicking the Table View button. In Table View, you can select different views from the **View** menu. [Table 18: Table Views](#) describes each of the menu options.

Table 18: Table Views

View By	Description
All	Lists all the items in the topology. The table is read-only. This is the default table.
CDP	Lists only nodes in the topology discovered through CDP. The information includes Device ID, Platform, and Software Version. This table is read-only.
Gigamon	Lists only Gigamon nodes. The information includes the Device ID (IP address of the node), Host Name, Box ID, Model, Cluster ID, and Cluster Mode (Standalone, Master, Slave, or Standby). Clicking on the IP address opens that Overview page for that node. This table is read-only.
LLDP	Lists only nodes in the topology discovered through LLDP. The information includes Chassis ID, System Name (if available), and Description (if available). This table is read-only.
Manual	Lists only manually added nodes in the topology. The information includes the Name, Vendor, Type, Mode, and Comment (if any). Each item has a checkbox. Selecting a checkbox for an item enables Edit and Delete in the Actions menu.
Links	Lists only the links in the topology. The information includes the Source Device, Source Port on the node, Source Type (CDP, LLDP, Gigamon Discovery, Gigamon, or Manual), Destination Device, Destination Port on the node, and Destination Type. Manually added links have a checkbox. Selecting a checkbox for an item enables Edit and Delete in the Actions menu.

How to Customize Topology

The Topology page automatically displays the Gigamon nodes managed by GigaVUE-FM and neighbor ports that are discoverable through LLDP, CDP, or Gigamon Discovery. However, you can customize the topology by adding custom nodes and links or modifying the alignment of items on the page.

Default Alignment

The first time Topology opens, GigaVUE-FM presents the elements in a predetermined alignment. The elements are aligned in general columns according to the following order from left to right:

1. Clusters and standalone nodes with links.
2. Manually added network nodes
3. Manually added TAPs
4. Clusters without links.
5. Standalone Gigamon nodes. These are ordered by dimension:
 - a. GigaVUE TAPs
 - b. GigaVUE-HC3

- c. GigaVUE-HC2
 - d. GigaVUE TA Series
6. Manually added tool nodes

You can restore the default alignment at any time by selecting **Actions > Reset Alignment**.

Move Elements in Topology

The Topology provides a context menu that makes it possible to quickly move elements on the page. To open the context menu, select an element and then right-click. For a traditional cluster configuration, [Figure 140: Context Menu Displayed for Traditional Configuration](#) shows the context menu with a number of options for aligning the elements in the topology. These options are:

- Align Neighbor
- Align Leaf Neighbor
- Align Cluster
- Select Neighbor

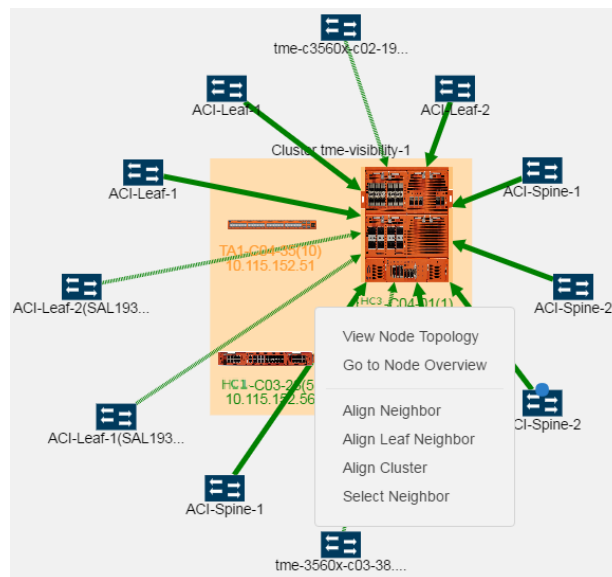


Figure 140: Context Menu Displayed for Traditional Configuration

For a leaf and spine topology, following options are displayed in the context menu (refer to [Figure 141: Context Menu Displayed for Leaf and Spine](#)):

- Align Neighbor
- Align Leaf Neighbor
- Align Cluster
- Align Cluster Spine

- Align Cluster Leaf
- Select Neighbor

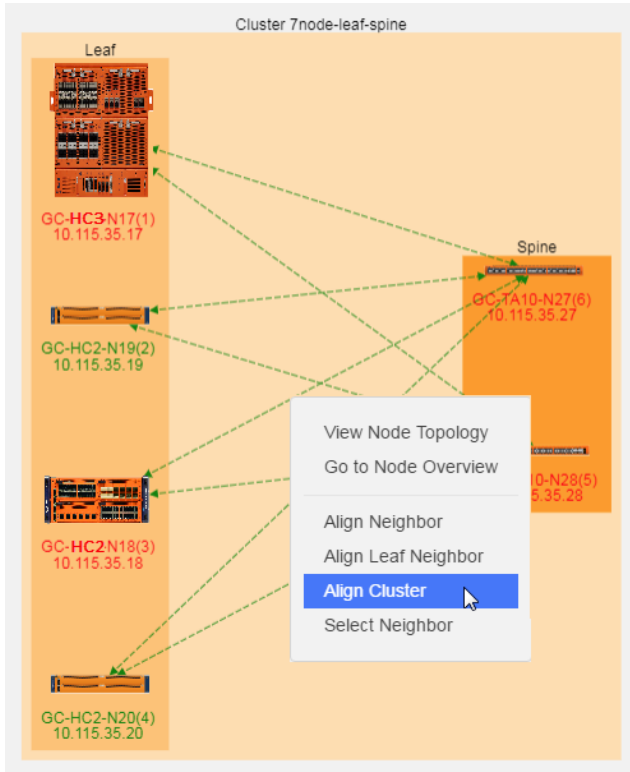


Figure 141: Context Menu Displayed for Leaf and Spine

Resize Links

When the topology is first created, a link may appear too long or too short. You can change the length of the link by selecting the node at either end of the link and dragging the node so that the link is the length that you want. For example, in [Figure 142: Long Link Between Devices](#), the link between the node named Packet Capture #1 and the node named HC2-Longevity in the cluster is too long. To make it shorter, select the node and drag it closer to the cluster.

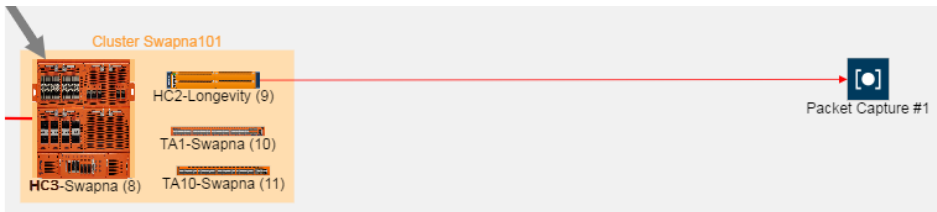


Figure 142: Long Link Between Devices

[Figure 143: Length of Link Adjusted](#) show the topology after dragging the node to adjust the length of the link.

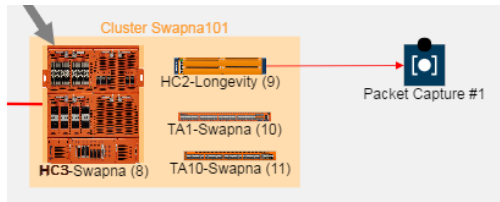


Figure 143: Length of Link Adjusted

In addition to dragging individual items on the page, you can use the **Align Neighbor** and **Align Leaf Neighbor** options from the context menu. For details, refer to [Align Neighbors](#) and [Align Leaf Neighbor](#).

Align Neighbors

The **Align Neighbor** option aligns all the neighbors of a selected node and any neighbors of those neighbors. The alignment follows the path of all the linked neighbors, aligning neighbors equidistant from the central neighbor based on a 360 degree arc. In [Figure 144: Aligning Neighbors](#), the GigaVUE-HD8-C04-01 has 12 neighbors. The neighbors are arranged at 30 degree angles around GigaVUE-HD8. If any of the neighbors have linked neighbors, the alignment of those neighbors are also calculated in the same manner. In [Figure 144: Aligning Neighbors](#), the linked neighbors are on one side of the cluster and all neighbors are on the left side of the cluster.

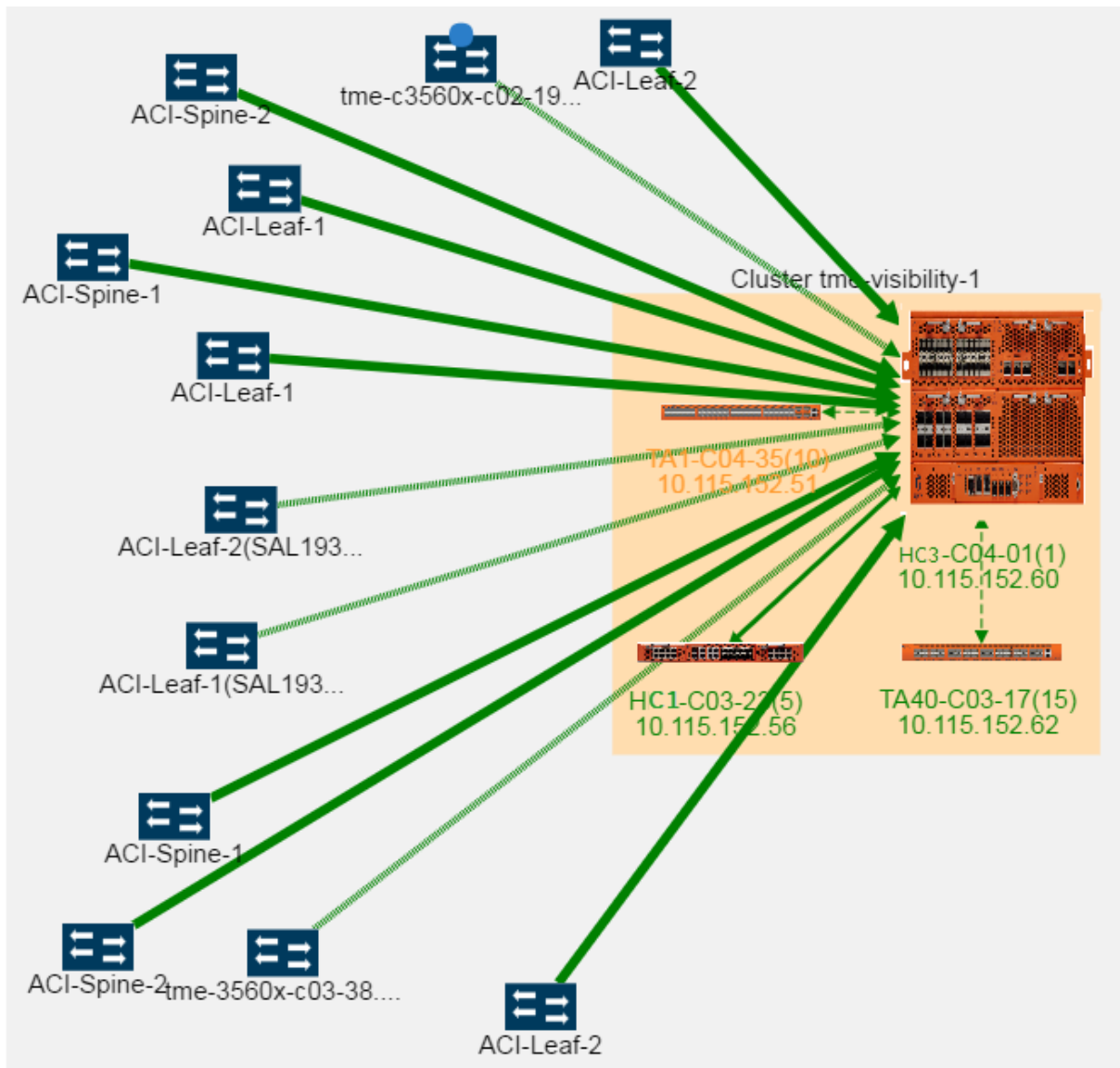


Figure 144: Aligning Neighbors

To realign the neighbors, do the following:

7. Select the cluster
8. Right-click to open the context menu and select **Align Neighbor**.

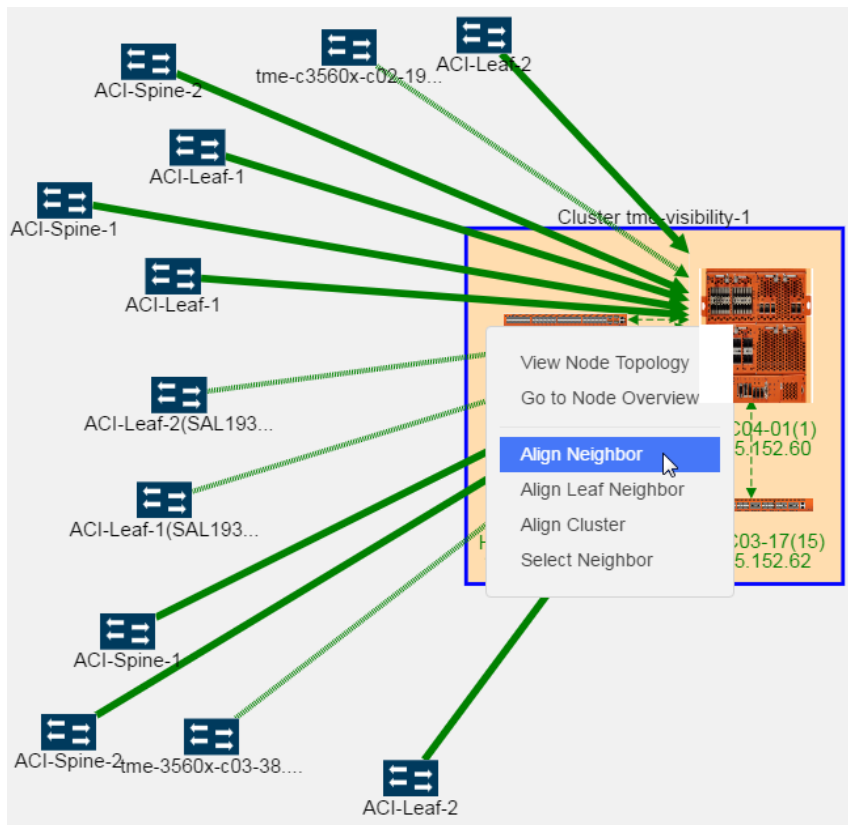


Figure 145: Displaying Align Neighbor Option

The neighbors are realigned around the selected element as shown in the following figure.

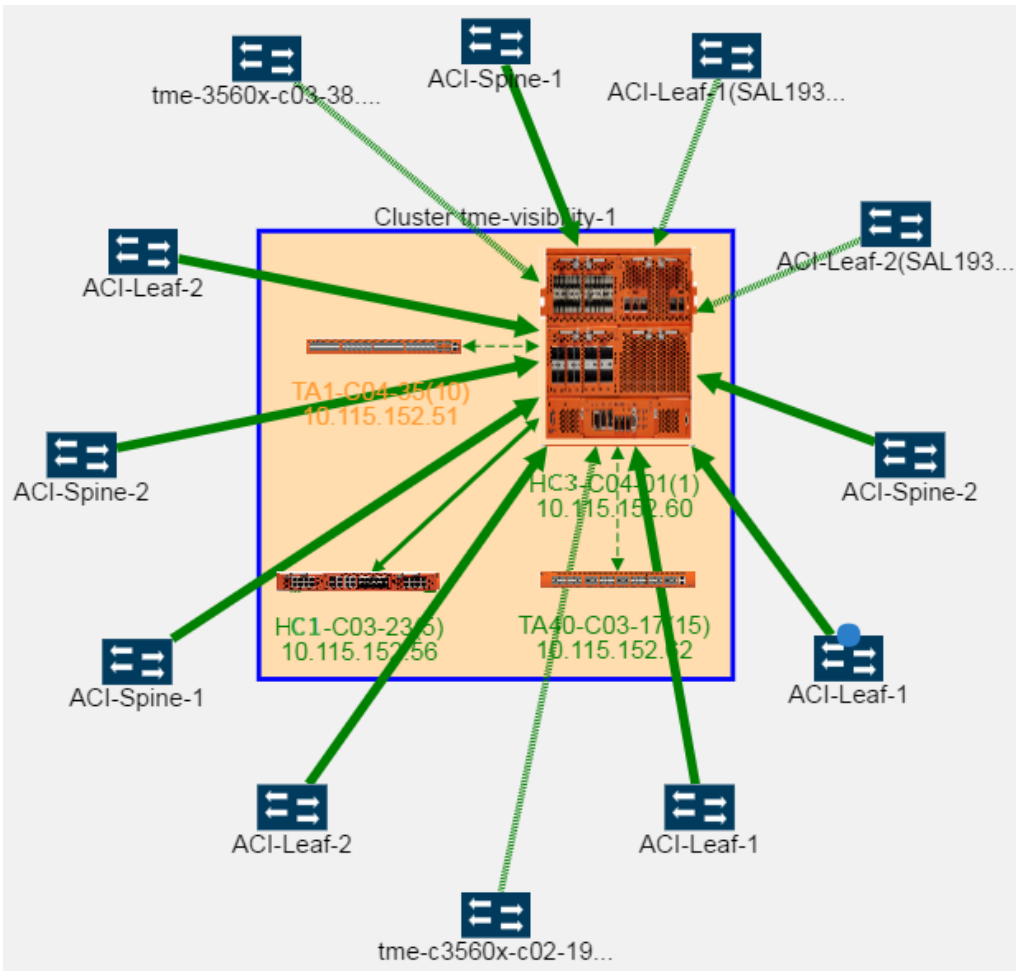


Figure 146: Nodes Aligned after Selecting Align Neighbor Option

When there are multiple neighbors, the alignment propagates through the topology. The neighbors of the selected element are aligned, then the neighbors of those neighbors, and so on throughout the topology. This makes it possible to realign an entire topology very quickly. In [Figure 147: Neighbor Alignment Propagation](#), the right-most element was selected and alignment propagation flows to the left and throughout the topology.

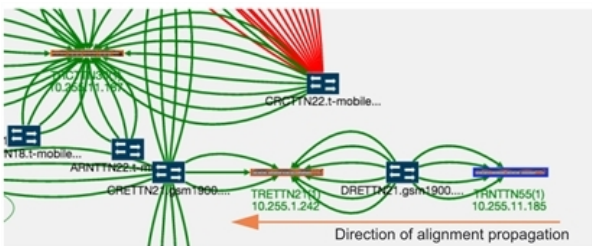


Figure 147: Neighbor Alignment Propagation

Align Leaf Neighbor

The **Aligning Neighbor** realigns all neighbors linked to the selected node and alignment is propagated throughout the topology. To align only the immediately adjacent neighbors, use **Align Leaf Neighbor**. The alignment will occur with the immediate neighbors and alignment will not propagate throughout the entire topology.

Align Cluster

Nodes within a cluster container can be repositioned by selecting and dragging individual nodes or using the **Align Cluster** option. To select this option, right-click on the cluster container and select **Align Cluster Spine** as shown in [Figure 148: Align Cluster Option Selected](#).

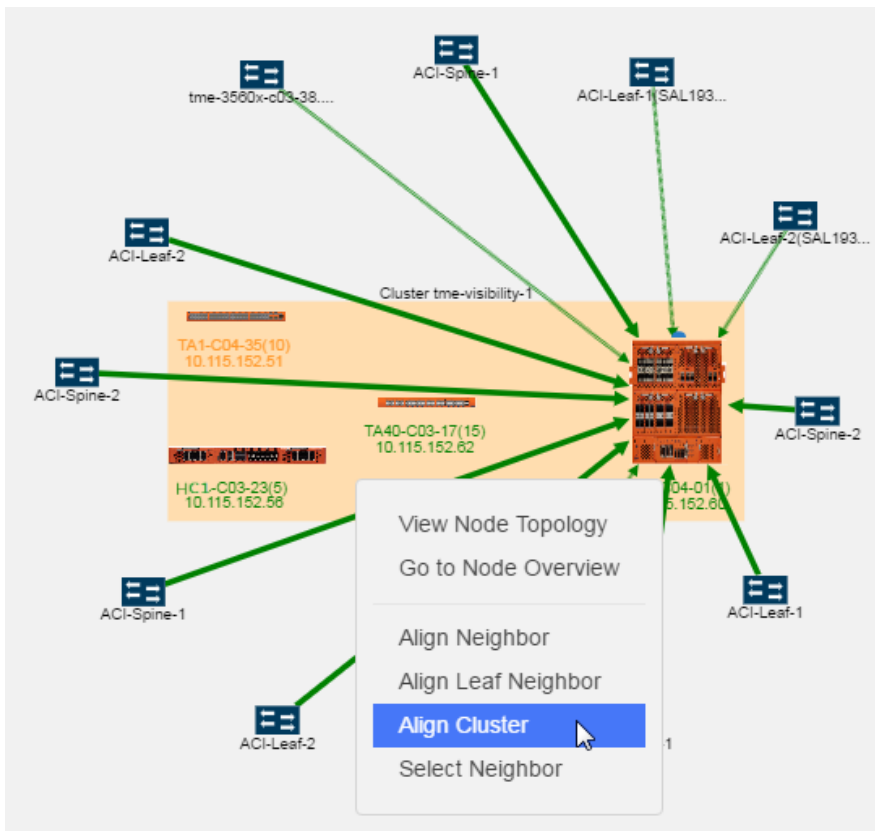


Figure 148: Align Cluster Option Selected

After selecting the Align Cluster option in [Figure 148: Align Cluster Option Selected](#), the nodes in the cluster are rearranged. [Figure 149: Nodes in a Cluster Container Arranged Horizontally](#) shows the results of applying **Align Cluster** to the cluster in [Figure 148: Align Cluster Option Selected](#).

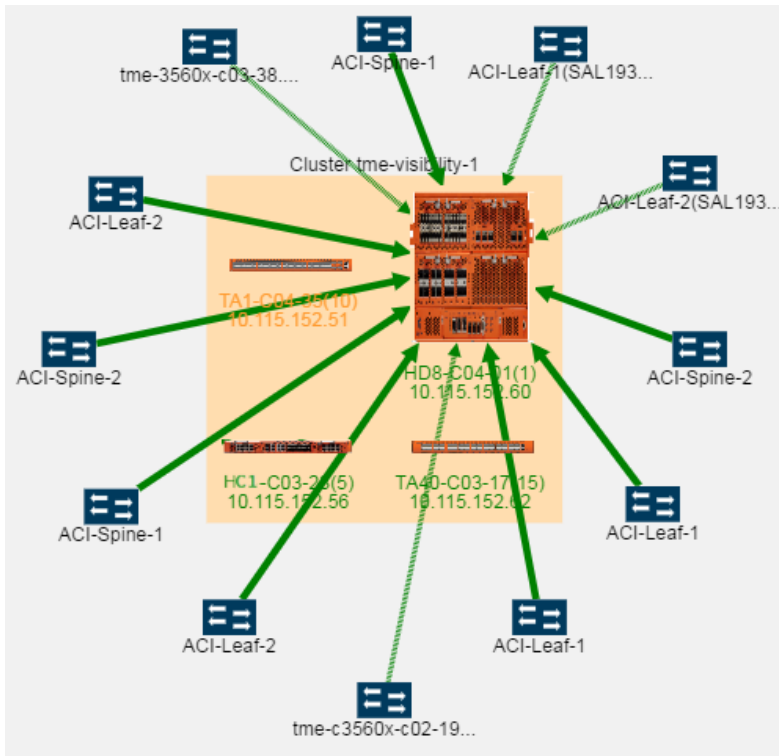


Figure 149: Nodes in a Cluster Container Arranged Horizontally

For leaf and spine cluster configuration, the Align Cluster option aligns the spine nodes within the spine container and leaf nodes within the leaf container.

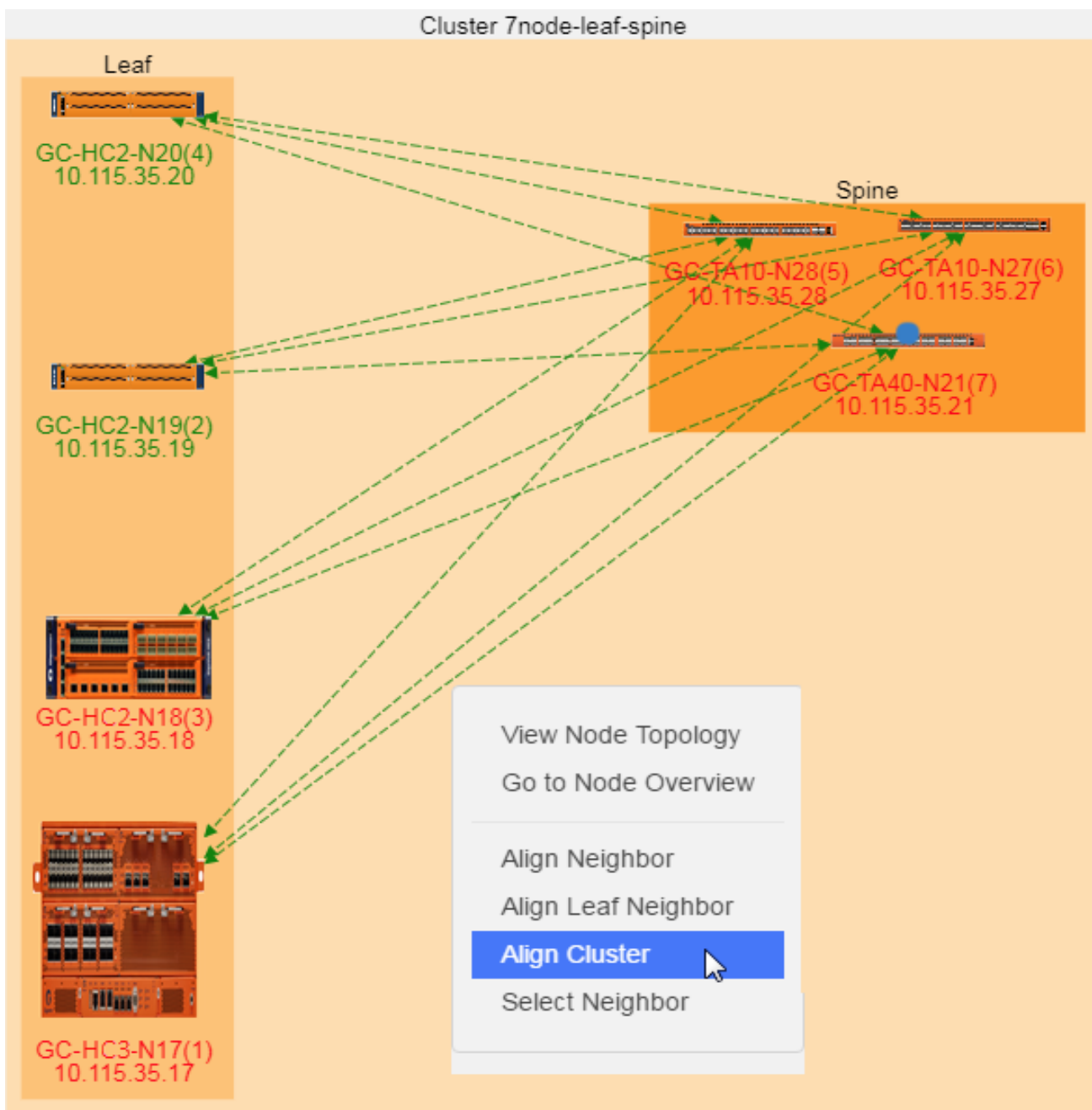


Figure 150: Displaying Align Cluster Option

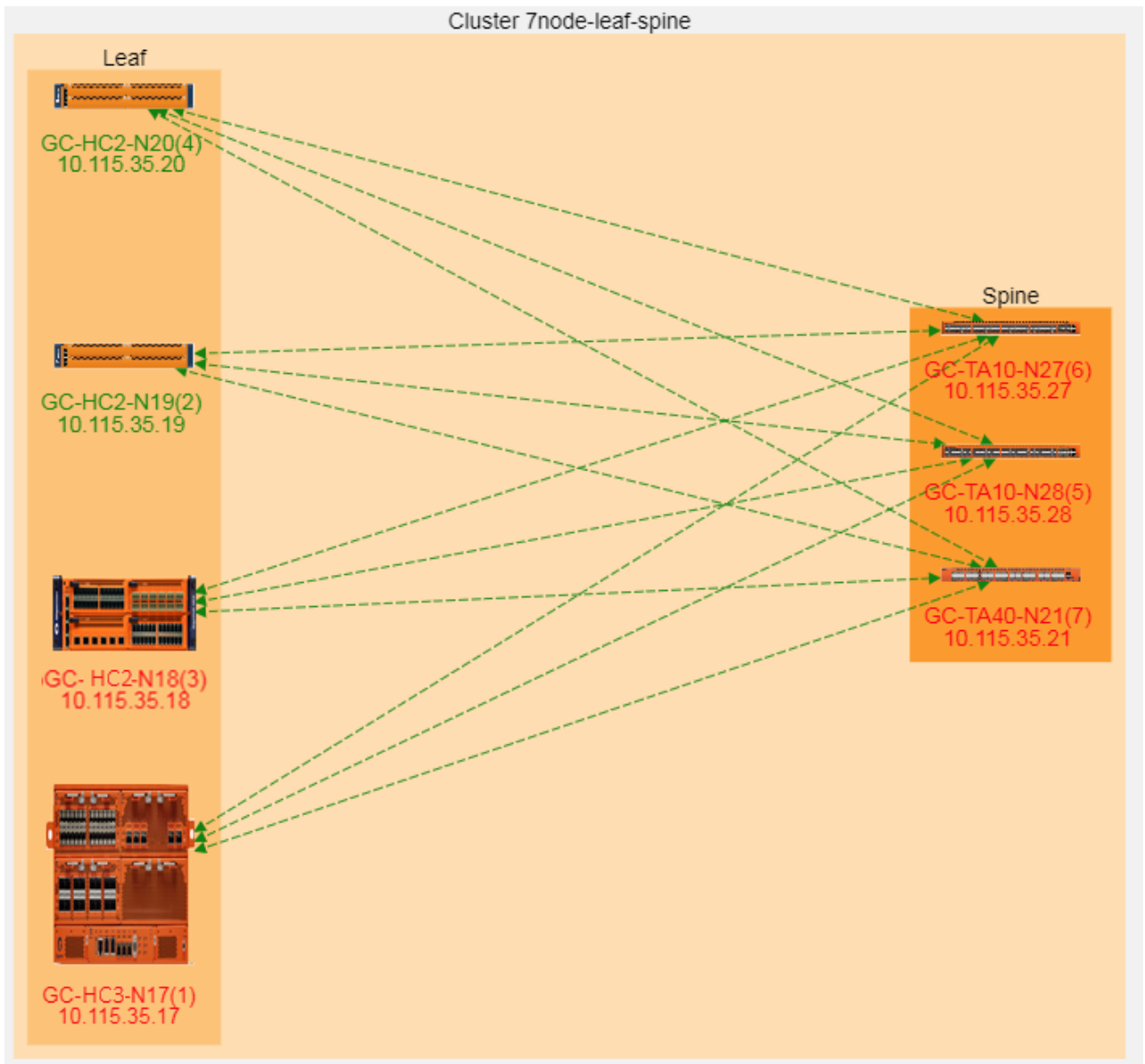
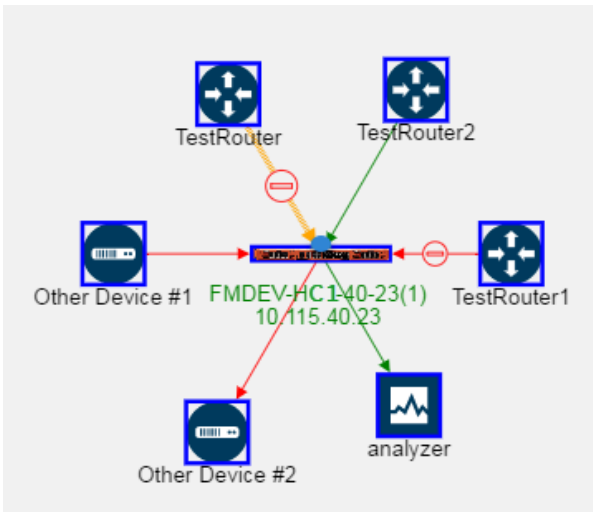


Figure 151: Spine and Leaf Nodes after Selecting Align Cluster Option

Select Neighbor

The **Select Neighbor** option is used to move an entire neighbor in the topology. This option selects a node or cluster and its linked nodes so you can move all of the elements at one time. To move a cluster or node and all its neighbors, do the following:

9. Select the cluster or node with linked neighbors.
10. Right-click to open the context menu and select **Select Neighbor**. The node or cluster and its neighbors are highlighted in blue. In the following figure, the GigaVUE-HB1 node and its linked neighbors are selected.



11. Drag the selected cluster and node to the new position. The linked neighbors will move with the node or cluster.

Manage Devices

This section describes the following:

- [Add Devices](#)
- [Edit Devices](#)
- [Delete Devices](#)
- [Add TAP](#)
- [Add Links](#)
- [Edit Links](#)

Add Devices

To add a node or nodes to the topology, do the following:

1. Select **Add > Add Device(s)**.

The Add Device page shown in the following figure displays.

Add Device(s)
Submit Cancel

+ -

Name

Vendor

Type

Model

Comment

Max Throughput **Gbps** ⓘ

Storage Capacity **TB** ⓘ

You can add additional nodes by clicking the + button. To remove a node, click the - button.

2. Enter the following information for the node:


- **Name**—the name of the node.
- **Vendor**—the node’s manufacturer. For Gigamon nodes, you cannot edit this field.
- **Model**—the model number of the node.
- **Comment**—optional description or additional information about the node.
- **Max Throughput** - the maximum throughput traffic currently being sent to this tool.
- **Storage Capacity** - the total processing capacity dedicated to all Gigamon ports physically connect to the tool.

NOTE: This field is not displayed when selecting a device type **Network**.

The information entered for the node displays when hovering over the icon on the topology. Also, the type selected determines the icon.

3. Click in the **Type** field to select the icon for this node. The possible types are as follows:

Type	Icon
Router	
Switch	
Virtual Switch	
Load Balancer	

Type	Icon
Firewall	
VOIP	
Cloud	
Analyzer	
Anti-Malware	
Customer Experience Management	
Application Performance Management	
Data Loss Prevention (DLP)	
Forensics	
Intrusion Detection System (IDS)	
Intrusion Prevention System (IPS)	
Next Generation Firewall (NGFW)	
SIEM	
Other	

- Click **Next**. The system returns to the Topology, where the new node appears on the page.

Edit Devices

To edit a node, do the following:

- Select the node.

6. Select **Actions > Edit**.

The Edit page opens, which displays information about the node and the links to the node.

7. On the Edit page, make the changes to the node or link information or both.
8. Click **Submit**.

NOTE: You cannot edit Gigamon nodes.

Delete Devices

To delete a single node from the topology, do the following:

9. Select the icon for the node in Topology View or select the checkbox in Table View.
10. Select **Actions > Delete**.
11. On the confirmation dialog, click **OK**.

To delete all nodes, select **Actions > Delete All**. All nodes and links are removed from the topology.

NOTE: You cannot delete Gigamon nodes from the topology.

Add TAP

In addition to nodes and links, you can add Gigamon TAPs to the topology with the TAP wizard or manually add the TAP and links.

To add a TAP with the wizard, do the following:

12. Select the links for the TAP.

To select the links, press Shift and select the two node links for the TAP.

13. Select **Add > Tap**.

The Add Tap page displays, which includes the dialogs for configuring the network and monitor links for network A and the network and monitors links for network B. The default names for the links are Network A, Network B, Monitor A, and Monitor B. [Figure 152: Add Tap Wizard](#) shows the Add Tap Wizard with a Gigamon G-TAP A-SF selected.

Add Tap Submit Cancel

Name _____

Vendor Gigamon

Model G-TAP A-SF

Comment _____

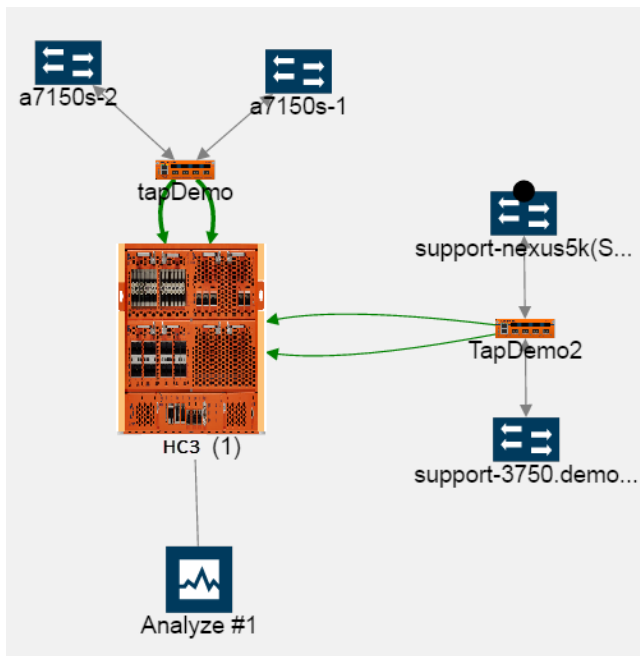
Source		Tap		Destination	
Device	00:1A:6D:5F:E3:93	Device		Device	10.115.94.4
Port	222	Network A	Network A	Port	2/1/x5

Source		Tap		Destination	
Device	00:1A:6D:5F:E3:8B	Device		Device	10.115.94.4
Port	111	Network B	Network B	Port	2/1/x3

Figure 152: Add Tap Wizard

14. Enter type a name for the TAP in the **Name** field.
15. Select a Gigamon TAP model from the list of **Models**.
16. (Optional) Add a comment about the TAP in the **Comment** field.
17. Click **Submit**.

The wizard adds the TAP and links to the topology as shown in the following figure, where TapDemo2 is the newly added TAP. When the TAP is added, it is initially placed in the lower right-hand corner of the page.



Manage Links

After adding nodes to the topology, you can add one or more links between nodes. However, there are some restrictions regarding links:

- CDP and LLDP links are read only.
- Only CDP and LLDP nodes can be the source for a TAP.
- Only a Gigamon node can be the destination for a TAP.

NOTE: When Gigamon discovery is enabled, the manual links that already exists between the two GigaVUE nodes are suppressed and only the Gigamon discovery links are shown.

Add Links

To add a link or links between nodes, do the following:

1. Click **Add > Link(s)** or click on the source node and drag a line from the dot that appears on the icon to the destination node as shown in the following figure.



The Add Link page shown in the following figure displays.

The screenshot shows the 'Add Link(s)' form with the following fields:

Source		Destination	
Device	Standalone 10.115.200.15	Device	Standalone 10.115.200.16
Port	Select port...	Port	Select port...

2. Select the source and destination ports for the link.

The **Device** fields for the Source and Destination nodes are automatically populated with the nodes that you selected for the link if you used the drag and drop method for creating the link. Otherwise, select the nodes from the drop-down lists.

- a. Under **Source**, click in the **Port** field and select the source port from the drop-down list.
- b. Under **Destination**, click in the **Port** field and select the destination port from the drop-down list.

The Add Links page should look similar to the following figure.

The screenshot shows the 'Add Link(s)' form with the following fields:

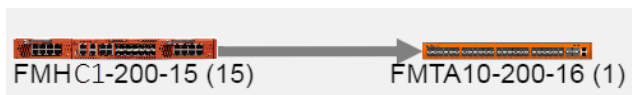
Source		Destination	
Device	Standalone 10.115.200.16	Device	Standalone 10.115.200.15
Port	N 1/1/q1	Port	T 15/1/g9

3. (Optional) Add another link by clicking the + button, and then repeat steps 2 and step 3.

NOTE: When adding more than one link between two nodes, both Source and Destination must contain information in the **Port** field.

4. Click **Submit**.

The topology shows a link between the two nodes.



Edit Links

To edit links, do the following:

1. Select the link to edit.

When you select a link with neighbors, all the neighbors are automatically selected.
2. Select **Actions > Edit**.

3. On the Edit Link page, make changes to the link information.
4. Click **Submit**.

Export and Import Topology

You can export the description of the topology to an Excel spreadsheet, which you can modify, and then import.

Export Topology

To export the Topology, click **Export**, which downloads an Excel spreadsheet. To identify the file, the filename ends in a timestamp string that is in the format `yyymmddhhmmss`.

The spreadsheet contains four sheets: Devices, Links, Gigamon Devices, and Discovered Links. The Gigamon Devices and Discovered Links pages are informational only. You can use the Devices and Links sheets for modifying and then import the information back to the GigaVUE-FM Topology. The format of the Gigamon Devices page is the same as the Gigamon Table View in the UI (refer to [Table View](#)).

Export exports all the manual links and manual nodes in a topology. Aggregated links are exported as the individual links of the aggregation. When exporting from the Cluster view, the expanded view of the aggregated links is exported.

Import Topology

Devices and links can be added to the Topology by importing an Excel spreadsheet that describes the custom nodes or links. When importing a spreadsheet, the spreadsheet must include a Device sheet and a Links sheet. The Devices sheet must have the following columns:

- Node Name
- Vendor
- Type
- Model
- Comment

The Type column can be any of the following:

- Router
- Switch
- Virtual Switch

- Load Balancer
- Firewall
- VOIP
- Cloud
- Analyzer
- Anti-Malware
- Customer Experience Management
- Application Performance management (APM)
- Packet Capture
- Data Loss Prevention (DLP)
- Forensics
- Intrusion Detection System (IDS)
- Intrusion Prevention System (IPS)
- Next Generation Firewall (NGFW)
- SIEM
- Other

The Links sheet must have the following columns:

- Source_Device
- Source_Port
- Source_Type
- Destination_Device
- Destination_Port
- Destination_Type

To import an Excel spreadsheet with node and link information, do the following:

1. Click **Import**.
2. Select one of the following:
 - Import Device(s)
 - Import Link(s)
3. On the Import page, do either of the following:
 - Click **Select File** and navigate to the file you want to import.
 - Drag and drop the file onto the page.

- 4. Click **Submit** to apply the spreadsheet information to the topology.

FabricVUE Topology Views

The FabricVUE Topology views allow you to visualize the complete underlying network topology graphically from GigaVUE-FM. There are two topology views available when viewing a node from GigaVUE-FM:

- Node Topology
- Map Topology

Node Topology

The Node Topology provides the same functionality as the Topology view displayed for all clusters nodes, and nodes discovered by GigaVUE-FM or manually added. For details, refer to [Overview of Topology](#). Node Topology displays the topology of individual clusters and standalone nodes and their immediate neighbors, whereas Topology displays all clusters nodes, and nodes discovered by GigaVUE-FM or manually added. Nodes in a cluster are displayed inside a yellow container. [Figure 153: Physical Node Topology of a Cluster](#) is an example of a cluster with four nodes and a number of connected nodes.

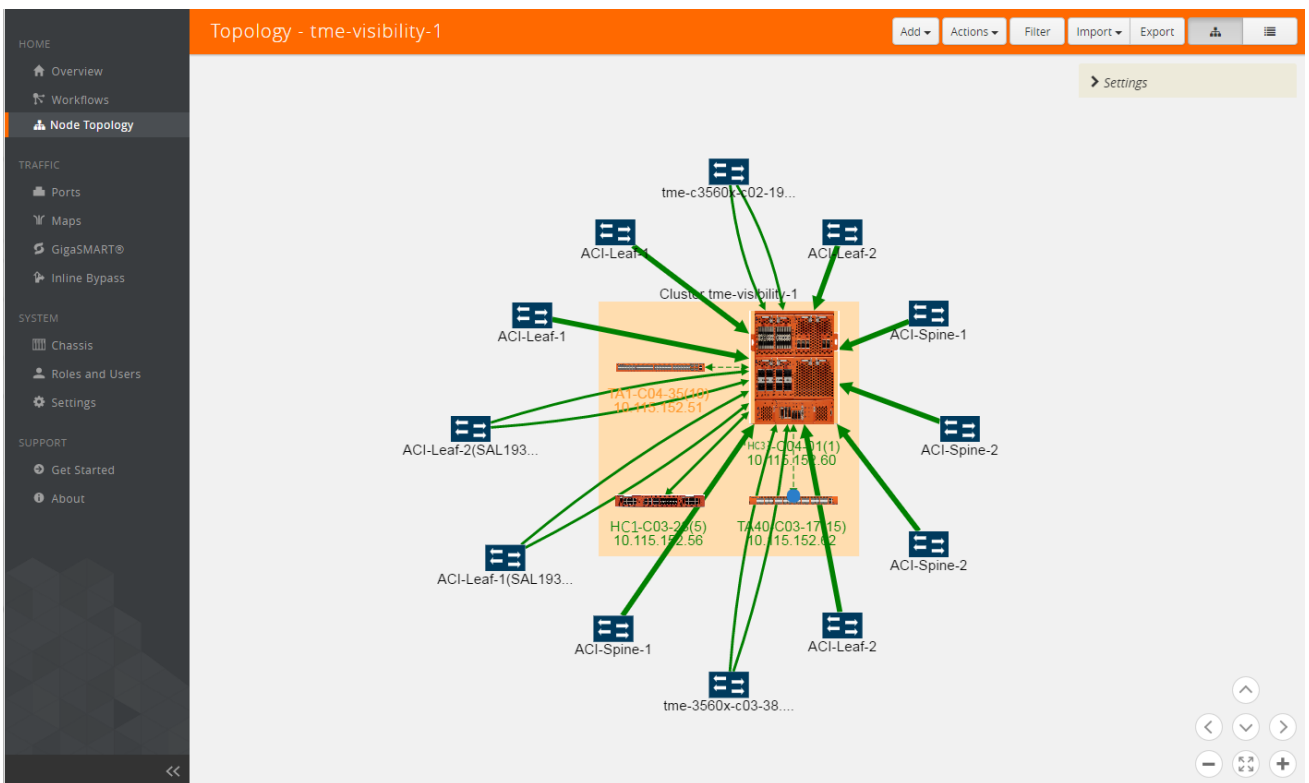


Figure 153: Physical Node Topology of a Cluster

In Node Topology, only the immediate neighbors of the node is displayed in the topology. [Figure 154: Node with Two Immediate Neighbors](#) shows a topology where the node with the host name HC2-03-13 was selected. It has two immediate neighbors, so the topology shows the node and its two neighbor nodes.

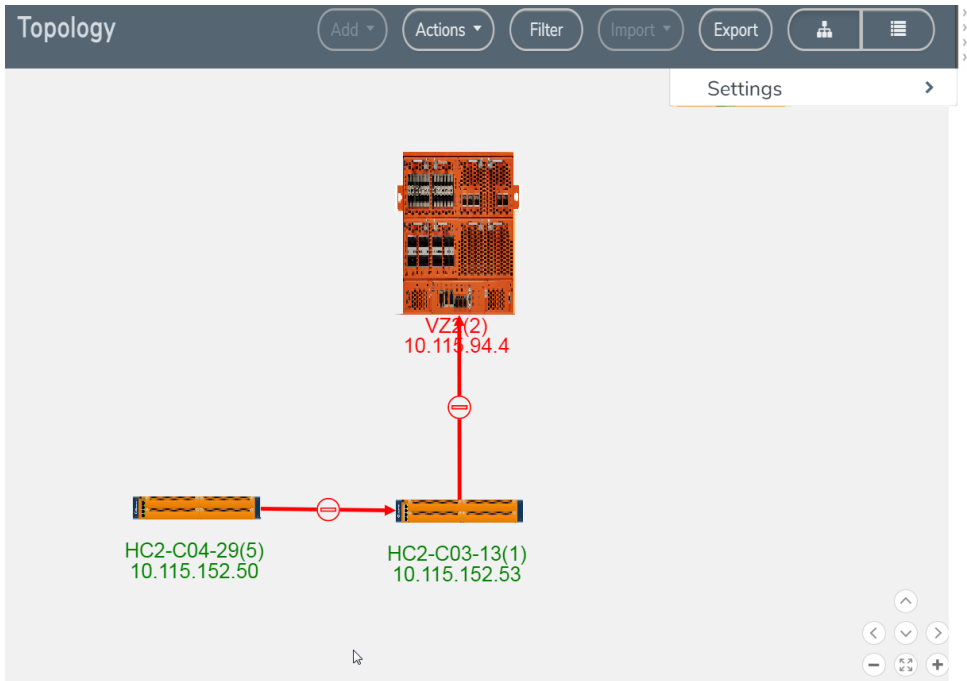


Figure 154: Node with Two Immediate Neighbors

However, if the node with the hostname HC2-C04-29 is selected, it has only one immediate neighbor HC2-C03-13, so the Node Topology shows only those two nodes.

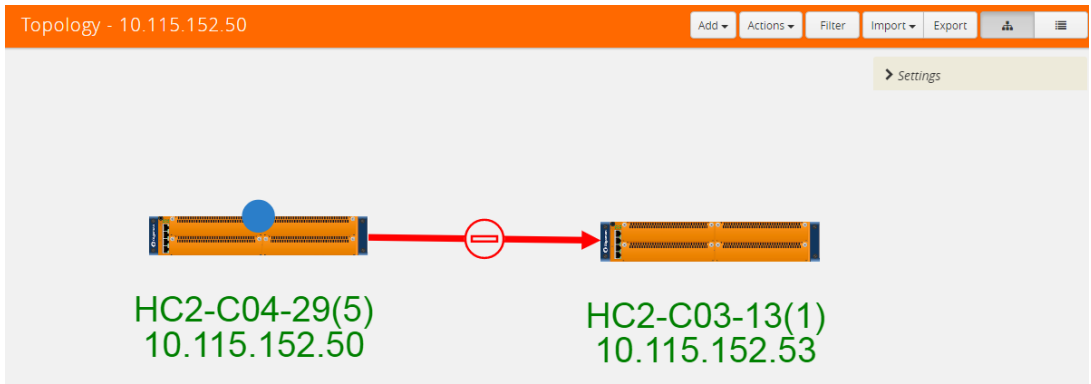


Figure 155: Node with One Immediate Neighbor

The labels for each node provide basic information about the node: hostname, box ID, IP address. The color of the label indicates the node's health. The node health colors are defined in [Table 19: Node Health Status](#).

Table 19: Node Health Status

Node Health Status	Meaning
Green	Node is healthy
Amber	Node is in a warning state
Red	Node is down
Gray	Node status is unknown or node is not reachable.

The orientation of the nodes in the cluster container can be changed with the **Align Cluster** option in the context sensitive menu that appears upon right-clicking the cluster. You can also rearrange the chassis icons by clicking on the icon and dragging it to a new location. For more information about repositioning and aligning element in the topology, refer to [Align Cluster](#).

Clicking on the graphic of a chassis shows the details about the chassis in a tool tip. In [Figure 156: Details in Node Topology](#), the details for a GigaVUE-HC3 is displayed.

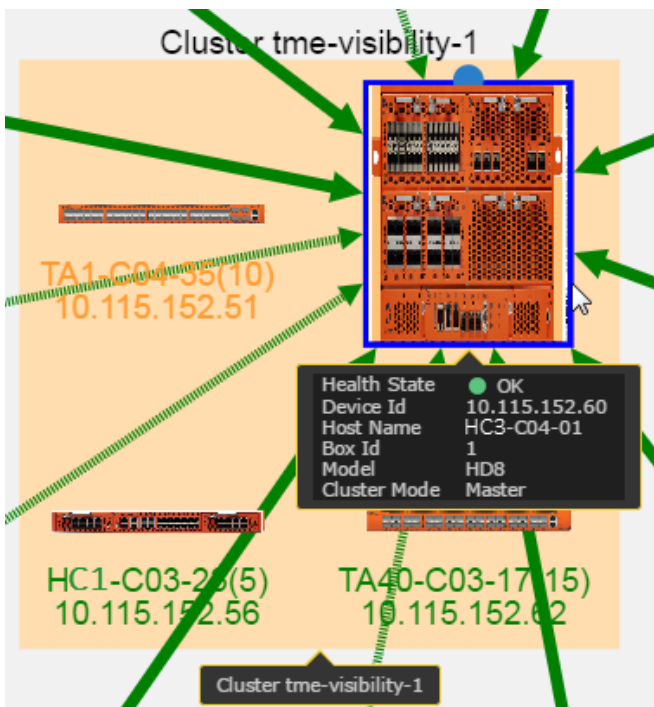


Figure 156: Details in Node Topology

The color of the links between nodes and nodes connected to the cluster indicate the link status between the nodes and cluster. Stack links between nodes in the cluster appear as dashed lines. In [Figure 153: Physical Node Topology of a Cluster](#), the stack links are between the GigaVUE-HC3 node, GigaVUE-TA1, and GigaVUE-TA10. The thickness of the lines indicates the bandwidth of the link. The color of the links indicated its status. The colors are defined in [Table 20: Link Status](#).

Table 20: Link Status

Link Status	Meaning
Green	Link is up
Amber	Link is in a warning state
Red	Link is down
Gray	Link is in an unknown state.

To display information about a link, click on the link to display a tool tip. The tool tip provides information about the link's state, health state, link type (LLDP, CDP, or Gigamon Discovery), source and destination nodes, and source and destination ports

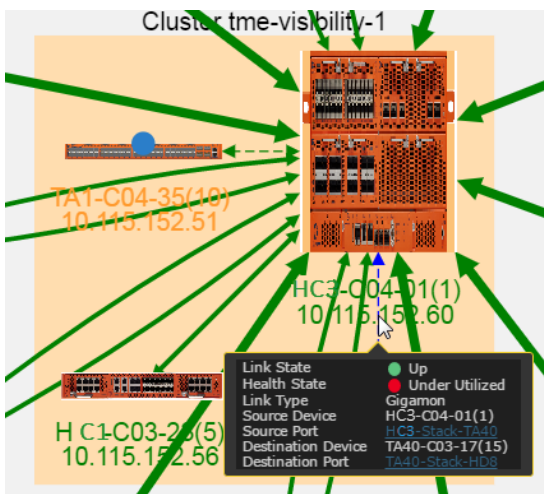


Figure 157: Link Information

To display details about a link, right-click on a link and select **More Details** from the context menu. A Link Details quick view opens (refer Figure 158: Link Details). For more information about the Link Details quick view, refer to [Link Details](#).

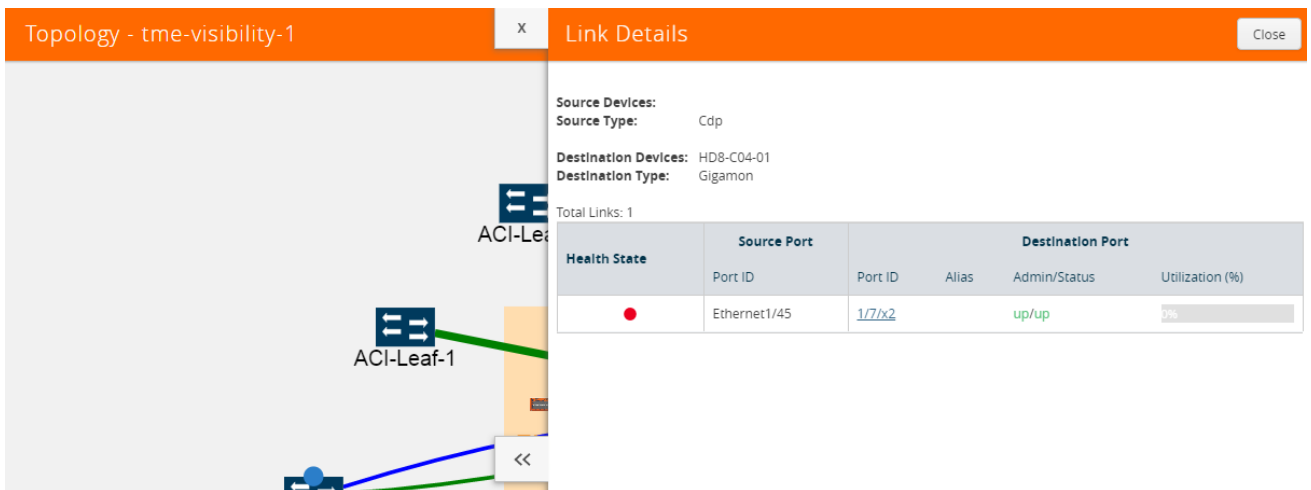


Figure 158: Link Details

For details about GigaStream stack link details in leaf and spine cluster configuration, refer to [GigaStream Stack Link Details](#).

Map Topology

When you access a physical node from GigaVUE-FM, and then select **Maps**, you can toggle the page between a list view and a topology view. Clicking the topology button changes the page to the topology view for the maps on the node. [Figure 159: Map Topology View](#) shows an example with network, hybrid, tools ports, and maps. A legend in the top-right corner of the page describes the icons shown in the diagram. The number of items in the legend depends on the icons used in the current graph. Use the controls in the lower right-hand corner of the page to position the map and zoom in or zoom out.

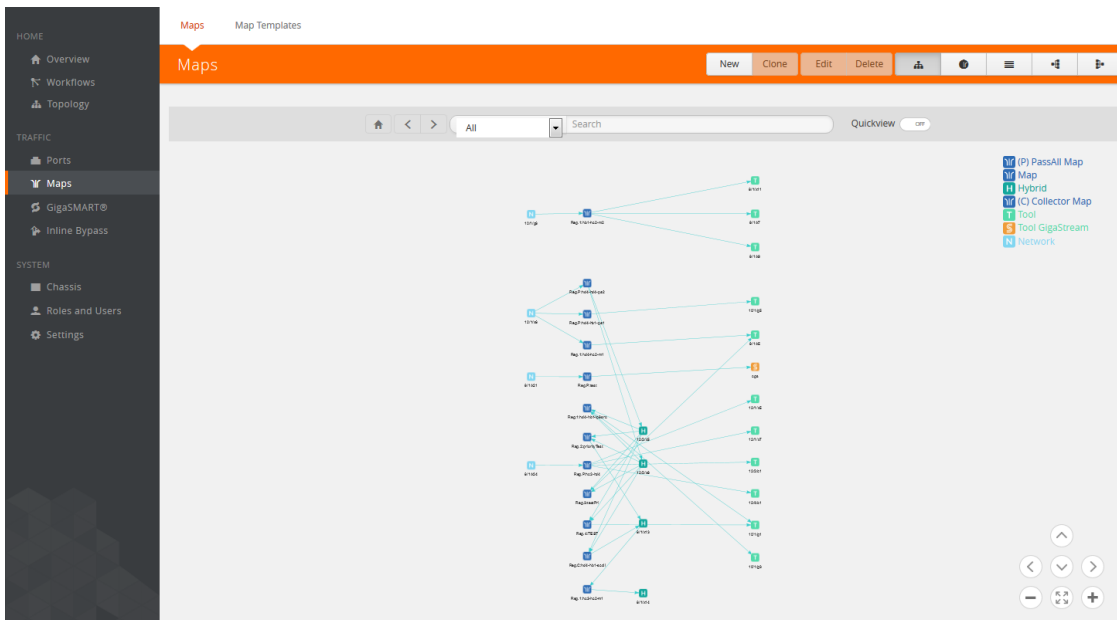


Figure 159: Map Topology View

Hovering over a node in the topology highlights the connections between ports and maps. For example, in [Figure 160: Source Port Selected and Paths Highlighted](#), hovering over the hybrid port highlights the path from the network port through the maps to the hybrid port and the destination ports.

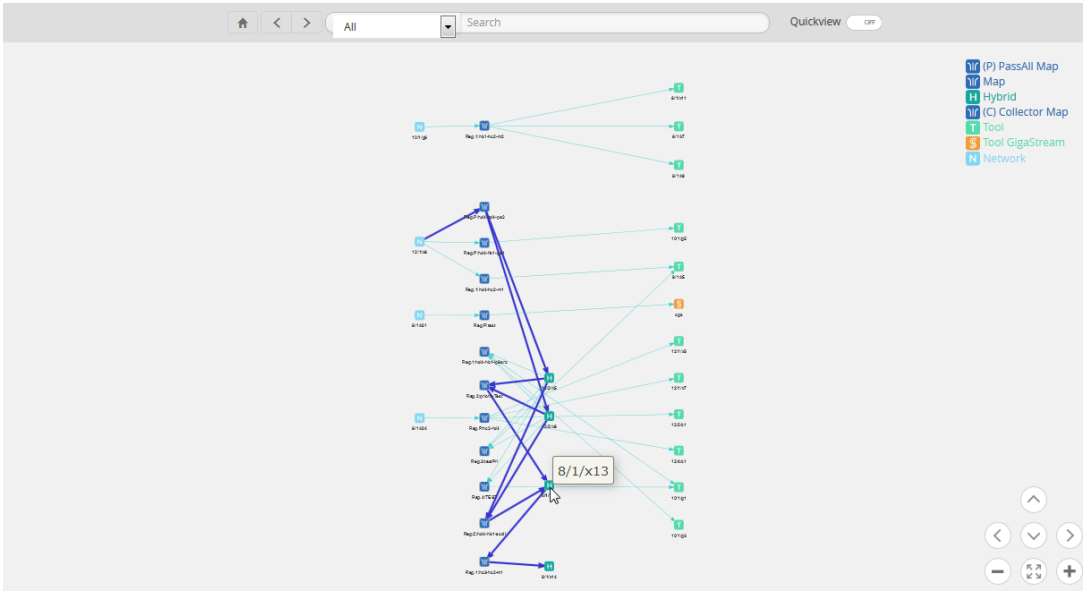


Figure 160: Source Port Selected and Paths Highlighted

Clicking on the item in the diagram displays only the connections for that item as shown in [Figure 161: Map Selected](#).

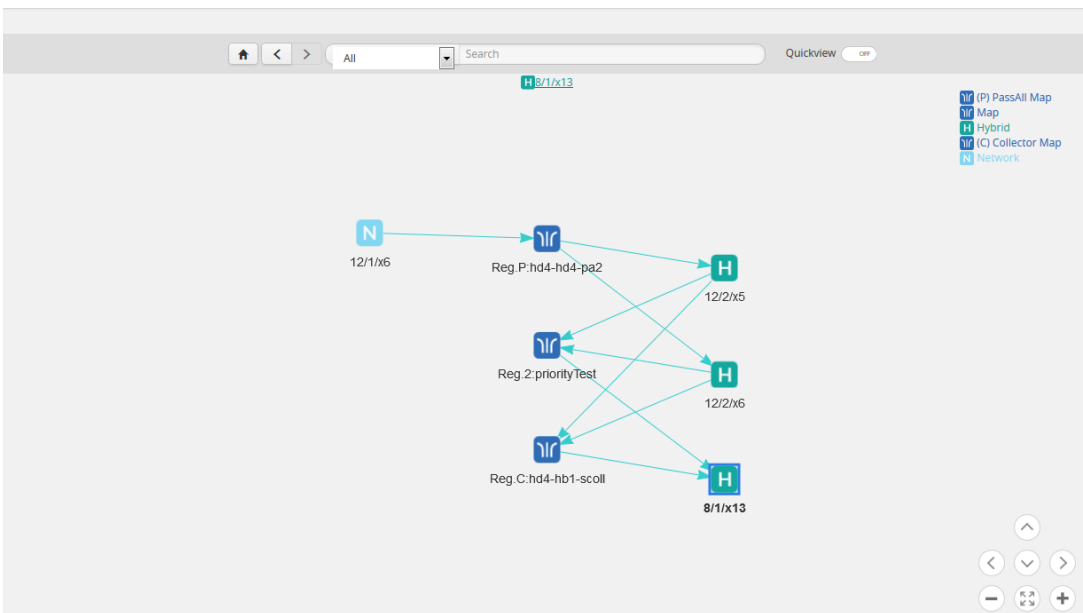


Figure 161: Map Selected

When an item in the diagram is selected, a link is displayed at the top of the page. Clicking on the link displays a quick view for that item. For example, if the item is a map, a Map quick view displays and if the item is a port, a Port quick view displays. [Figure 162: Map Quick View from Map FabricVUE](#) shows an example, where port 8/1/x13 is selected and the quick view for the port is displayed.

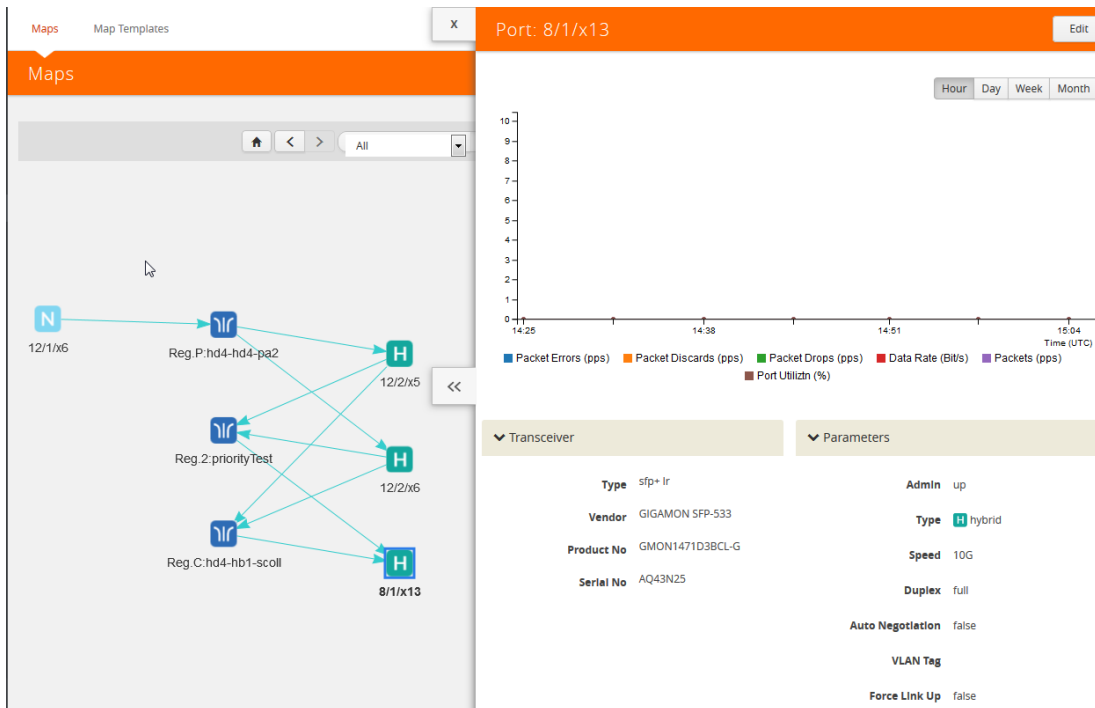


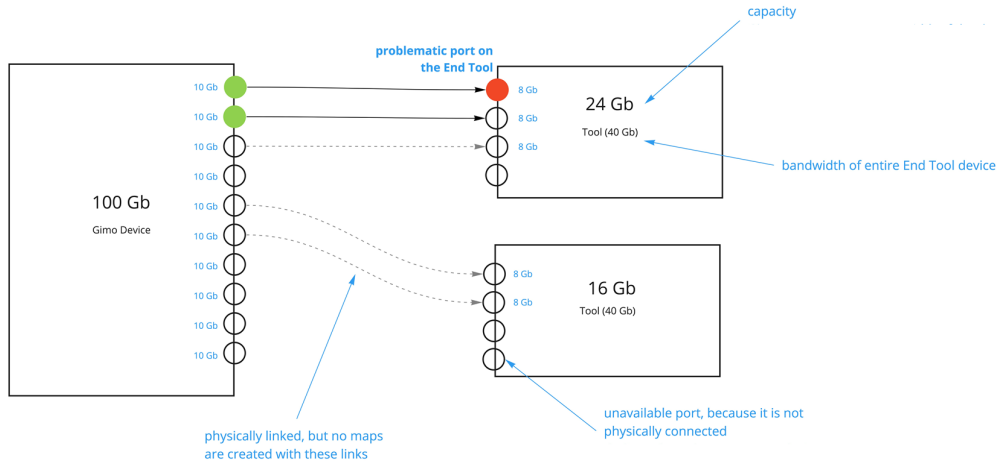
Figure 162: Map Quick View from Map FabricVUE

Redistribute Traffic Flows

GigaSMART software version 5.4 provides support for redistributing traffic flows from a particular tool port to other available tool ports with available capacity. When traffic flows from tools ports to end tool ports that exceed their traffic bandwidth, those end tool ports become problematic, as shown in the illustration below.

To use this feature the users have to create a tool device by entering throughput and storage capacity they wish to allocate for Gigamon ports. After the device is created, the user can create inks between Gigamon devices and manual devices. Based on the number of incoming links to tool, total traffic per port, max throughput and storage capacity, the wrap around time and current throughput percentage % is calculated.

When a tool device is linked to Gigamon device(s), it is included as a part of the traffic flows. if a Gigamon device with maps and ports is linked to a tool device, then the terminal vertex of the flow is the tool device. Flow health for a flow connected to a tool device is then be calculated by taking into consideration the current throughput percentage% of the tool device along with existing parameters



Support for this functionality includes the following:

- Listing all the Tools that are present in Fabric Manager
- Troubleshooting if there is any problem with the port that is connected to tool
- Listing the total traffic flowing to the tool from the Gigamon ports that are connected to the tool.
- Analyzing the traffic by sending or duplicating it to another port or tool.
- Redistributing the traffic to one or more available tool ports.
- Moving all traffic from the problematic port to another tool.


Redistribute traffic to one or more available tool ports

This section describe the tasks associated with redistributing traffic flow from one tool port to another available tool port.

Add Devices

1. Add a new tool and indicate the **Max Throughput** and **Storage Capacity** the tool will dedicate to Gigamon ports.

Add Device(s)
Submit Cancel

+ −


Name

Vendor

Type

Model

Comment

Max Throughput **Gbps** ⓘ

Storage Capacity **TB** ⓘ

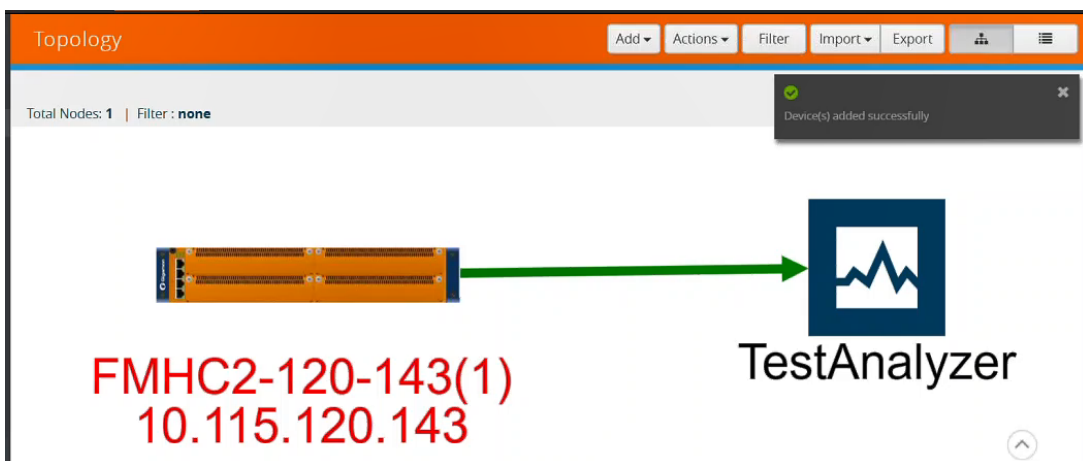
2. Enter the following information for the node:

- **Name**—the name of the node.
- **Vendor**—the node's manufacturer. For Gigamon nodes, you cannot edit this field.
- **Model**—the model number of the node.
- **Comment**—optional description or additional information about the node.
- **Max Throughput** - the maximum throughput traffic currently being sent to this tool.
- **Storage Capacity** - the total processing capacity dedicated to all Gigamon ports physically connect to the tool.

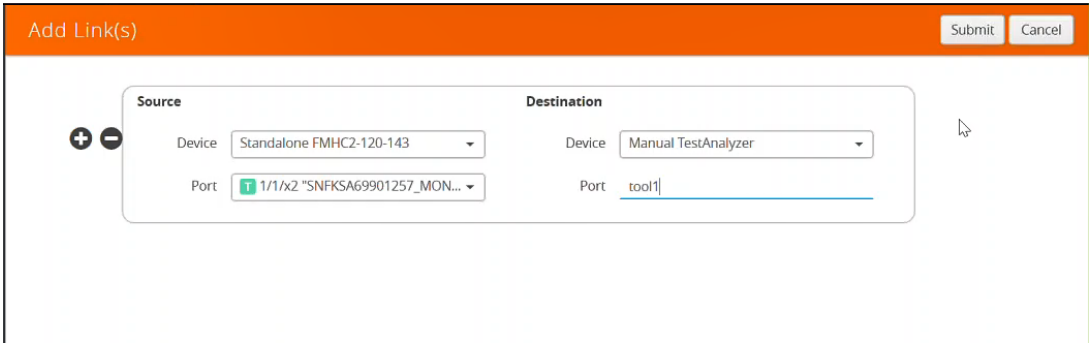
NOTE: This field is not displayed when selecting a device type **Network**.

The information entered for the node displays when hovering over the icon on the topology. Also, the type selected determines the icon.

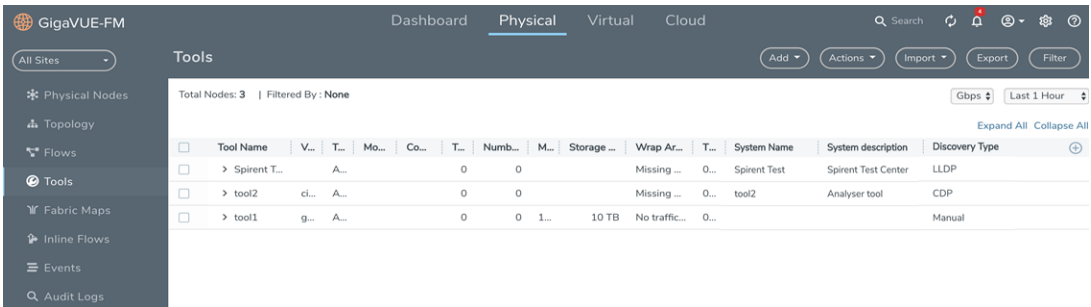
3. Create a link from the Gigamon device to the new tool you created in **Step 1** and provide the Gigamon ports that are connected to the new tool you created.



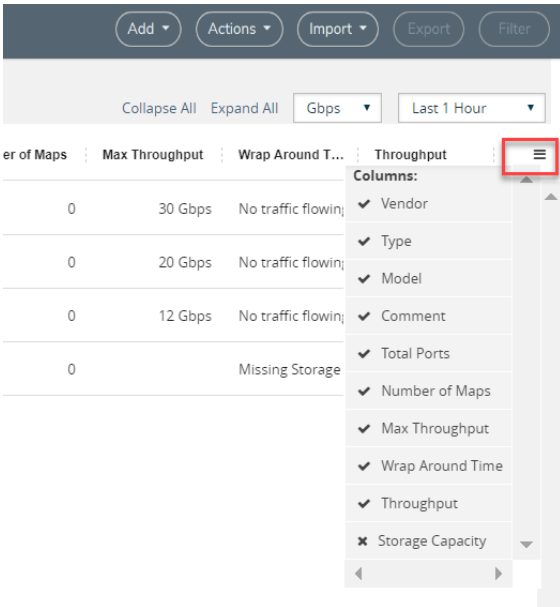
4. Add the Device links **Source** and **Destination port** details.



5. Click **Submit**.
6. Click **Physical > Tools** to display the Tools page with new tool you created in first Step.



The Tools page displays the available Tools in your network topology, including the tool you created and the associated traffic flows. Using this screen you can view the traffic being handled by each tool port. The columns show details about the tool port. The columns can be changed using the + icon in right corner of the screen.



- Use the metrics drop-down to view the traffic throughput in **Mbps** or **Gbps**.
- Use the **Last time** drop-down to select and view the tool port traffic for a specific time period.

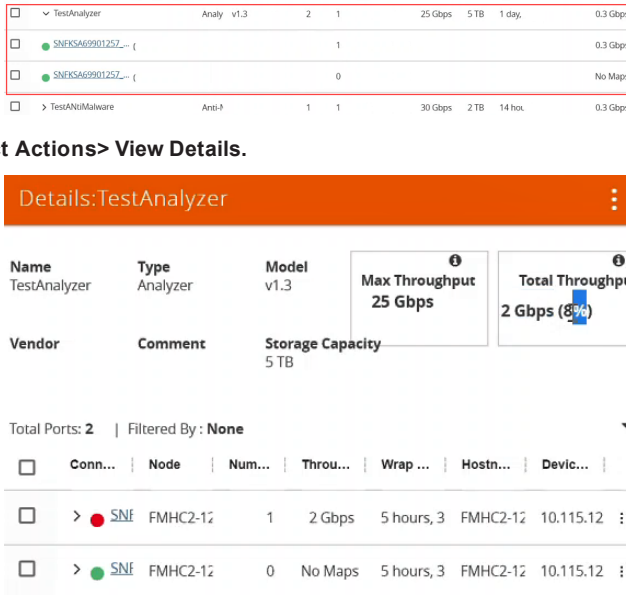
Redistribute Traffic to Another Port

Traffic that may be problematic for one tool port can be moved and redistributed to another tool port. Using the Tools page you can list the total traffic flowing to the tool from the Gigamon ports that are connected to the tool. The Tools page will help you analyze the traffic for redistribution by sending or duplicating it to another port or tool.

Example: Redistribute Traffic to Another Port

Below

Task	UI Steps
<p>Add a new tool and indicate the Max Throughput and Storage Capacity the tool will dedicate to Gigamon ports.</p>	<p>Select Add > Add Device(s). You can add additional nodes by clicking the + button. To remove a node, click the - button.</p> <p>Enter the following information for the node:</p> <ul style="list-style-type: none"> • Name—the name of the node. • Vendor—the node's manufacturer. For Gigamon nodes, you cannot edit this field. • Model—the model number of the node. • Comment—optional description or additional information about the node. • Max Throughput - the maximum throughput traffic currently being sent to this tool. • Storage Capacity - the total processing capacity dedicated to all Gigamon ports physically connect to the tool. <p>Click in the Type field to select the icon for this node.</p> <p>Click Next. The system returns to the Topology, where the new node appears on the page.</p>
<p>Create links between Gigamon devices and manual device. Based on the number of incoming links to tool, total traffic per port, max throughput and storage capacity, the wrap around time and current throughput % is calculated.</p>	<p>Click Add > Link(s) or click on the source node and drag a line from the dot that appears on the icon to the destination node.</p> <p>Select the source and destination ports for the link.</p> <ul style="list-style-type: none"> • The Device fields for the Source and Destination nodes are automatically populated with the nodes that you selected for the link if you used the drag and drop method for creating the link. Otherwise, select the nodes from the drop-down lists. • Under Source, click in the Port field and select the source port from the drop-down list. • Under Destination, click in the Port field and select the destination port from the drop-down list.

Task	UI Steps																																									
	<ul style="list-style-type: none"> (Optional) Add another link by clicking the + button, and then repeat steps 2 and step 3. <div style="border: 1px solid #ccc; padding: 5px; margin: 5px 0;"> <p>NOTE: When adding more than one link between two nodes, both Source and Destination must contain information in the Port field.</p> </div> <p>Click Submit.</p>																																									
<p>Use the Tools page detail views to analyze current traffic flows to tool ports. Use the Max Throughput and Storage Capacity data to help determine if any tool port receiving traffic is near or at capacity. Users can identify any available tool port to redistribute traffic.</p>	<p>Click Physical > Tools. The Tools page list all ports available in your network receiving traffic from devices. Select one of the ports receiving traffic.</p> <p>Expand a port to see which maps are sending traffic to that port.</p>  <p>Select Actions> View Details.</p> <div style="border: 1px solid #ccc; padding: 5px; margin: 5px 0;"> <p>Details: TestAnalyzer</p> <table border="1"> <tr> <td>Name</td> <td>TestAnalyzer</td> <td>Type</td> <td>Analyzer</td> <td>Model</td> <td>v1.3</td> <td>Max Throughput</td> <td>25 Gbps</td> <td>Total Throughput</td> <td>2 Gbps (8%)</td> </tr> <tr> <td>Vendor</td> <td></td> <td>Comment</td> <td></td> <td>Storage Capacity</td> <td>5 TB</td> <td></td> <td></td> <td></td> <td></td> </tr> </table> <p>Total Ports: 2 Filtered By: None</p> <table border="1"> <thead> <tr> <th>Conn...</th> <th>Node</th> <th>Num...</th> <th>Throu...</th> <th>Wrap ...</th> <th>Hostn...</th> <th>Devic...</th> </tr> </thead> <tbody> <tr> <td>></td> <td>SNF FMHC2-12</td> <td>1</td> <td>2 Gbps</td> <td>5 hours, 3</td> <td>FMHC2-12</td> <td>10.115.12</td> </tr> <tr> <td>></td> <td>SNF FMHC2-12</td> <td>0</td> <td>No Maps</td> <td>5 hours, 3</td> <td>FMHC2-12</td> <td>10.115.12</td> </tr> </tbody> </table> </div> <p>From the Details pane you can view the traffic flow for each tool port. Here you can determine if a tool port is at or near capacity and decide if you want to move it to another port with availability and linked to the device.</p>	Name	TestAnalyzer	Type	Analyzer	Model	v1.3	Max Throughput	25 Gbps	Total Throughput	2 Gbps (8%)	Vendor		Comment		Storage Capacity	5 TB					Conn...	Node	Num...	Throu...	Wrap ...	Hostn...	Devic...	>	SNF FMHC2-12	1	2 Gbps	5 hours, 3	FMHC2-12	10.115.12	>	SNF FMHC2-12	0	No Maps	5 hours, 3	FMHC2-12	10.115.12
Name	TestAnalyzer	Type	Analyzer	Model	v1.3	Max Throughput	25 Gbps	Total Throughput	2 Gbps (8%)																																	
Vendor		Comment		Storage Capacity	5 TB																																					
Conn...	Node	Num...	Throu...	Wrap ...	Hostn...	Devic...																																				
>	SNF FMHC2-12	1	2 Gbps	5 hours, 3	FMHC2-12	10.115.12																																				
>	SNF FMHC2-12	0	No Maps	5 hours, 3	FMHC2-12	10.115.12																																				
<p>Redistribute traffic flow from one tool port to another available tool port. Replace an existing port with another port that is currently linked to the end tool.</p>	<p>From the Tools page expand a port to view which maps are sending traffic to that port.</p> <p>Select a Device</p> <p>Select a different map from the current map that is at or near capacity to send traffic.</p> <p>Click Tools> Actions> Edit</p> <ul style="list-style-type: none"> - Enter information for the node as you did in the first task. - Add the Device links Source and Destination port details. 																																									

Task	UI Steps
	<p>Click Submit.</p> <p>The tools page shows the available tool port with the new traffic flow data.</p>

is an example of Redistributing Traffic to Another Port.Viewing Traffic Flow

View Traffic Flows

To view tool port traffic flow, do the following.

- Navigate to Physical > **Flows**. Flows for all nodes in your network topology displays based on the filter parameters. You can change the display of the flow details by clicking the **Filter** button and modifying the filter parameters.

Name	Cluster/Tool	Host Name	Status	Total Ports	Total Unhealthy P...	Total Maps	Total Unhealthy M...	Last Computed Tl...
TestAntiMalware	Tool	Not Available	● Maps [level2, L...	2	2	2	2	2018-07-11 17:05:03
1/3/c6	tom-cluster	ta40-test	● Maps [map2] ...	1	0	1	1	2018-07-11 17:05:03
2/4/c6	14	HC3-PREM	● Flow is healthy	2	0	1	0	2018-07-11 17:05:03
2/4/c5	14	HC3-PREM	● Flow is healthy	2	0	1	0	2018-07-11 17:05:03
1/4/a3	10.60.94.15	HDB-6046	● Unable to retr...	2	0	1	0	2018-07-11 17:05:03
1/1/c3x1	10.115.6.62	A11-shankar	● Node [A11-sh...	2	1	1	1	2018-07-11 17:05:03

- Click the name of the node to display the flow.

View Tool Port Details

To view Tool Port Details:

- Click **Physical > Tools**. A listing of all the tools displays.

Tool Name	V.	T.	Mo...	Co...	T...	Numb...	M...	Storage ..	Wrap Ar...	T...	System Name	System description	Discovery Type
> Spirent T...	A...					0	0		Missing ...	0...	Spirent Test	Spirent Test Center	LLDP
> tool2	cl...	A...				0	0		Missing ...	0...	tool2	Analyser tool	CDP
> tool1	g...	A...				0	0	1...	10 TB	No traffic...	0...		Manual

- Select a **device**.
- Click **Actions > View Details**.

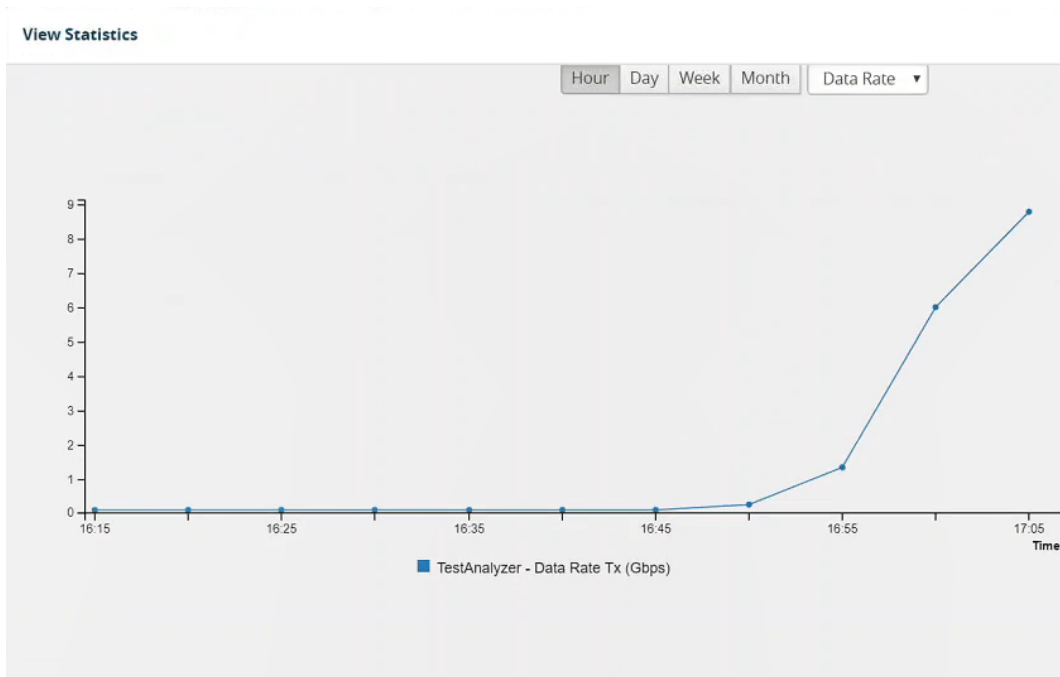
The screenshot displays the 'Tools' management interface. On the left, a table lists tools with columns for 'Tool Name', 'Ve...', 'Type', and 'Model'. The 'TestAnalyzer' tool is selected. On the right, the 'Details:TestAnalyzer' view provides specific metrics: 'Max Throughput 25 Gbps' and 'Total Throughput 2 Gbps (8%)'. Below these metrics, a table shows 'Total Ports: 2' with columns for 'Conn...', 'Node', 'Num...', 'Throu...', 'Wrap ...', 'Hostn...', and 'Devic...'. Two ports are listed, both connected to 'SNF FMHC2-12' nodes.

- **Max Throughput** - Sum of all port's throughput connected to the tool device.
- **Current Throughput%** - Total throughput / Maximum Through (User entered data for that Tool).
- **Wrap Around Time** - Total Storage (User entered data for the Tool)/Current Throughput.

View Tool Port Statistical Graph

To view Tool Port Statistical data:

12. Click **Physical > Tools**.
13. Select a **device**.
14. Under the **Actions** drop down, select **View Statistical Graph**. The statistics is an aggregated graph of all the ports connected to the tool device.



Flows

This chapter describes what is a flow and how to quickly view the packet drops and packet errors that are causing the flow to be unhealthy.

Refer to the following sections for details:

- [About Flows](#)
- [View Flows](#)
- [View the Flow Summary and Statistics](#)
- [How to Change the Flow Layout](#)
- [How to Update Flows](#)
- [View Events](#)
- [Set Notifications](#)
- [Limitations of Flows](#)

About Flows

Flows provide the ability to view the traffic flowing from a network port that receives the traffic from a network TAP to the tool port that sends the traffic to the tools.

A flow is constructed by traversing backward starting from the egress tool port connected to the monitoring tools all the way up to the network ports that receive the traffic from a network TAP. If there are five egress tool ports sending the traffic out to the monitoring tools, there will be five flows displayed in the Flows page.

Figure 163: Flow - All Sites shows an example of a flow. It illustrates the network ports that receive the packets from different sources, a set of map rules that filter the packets, and the egress tool port that sends the packets to the monitoring tools. A flow name is determined by the egress tool port ID or alias. In this example, the flow name is SPEGE0070_Te5, which is the name of the egress tool port.

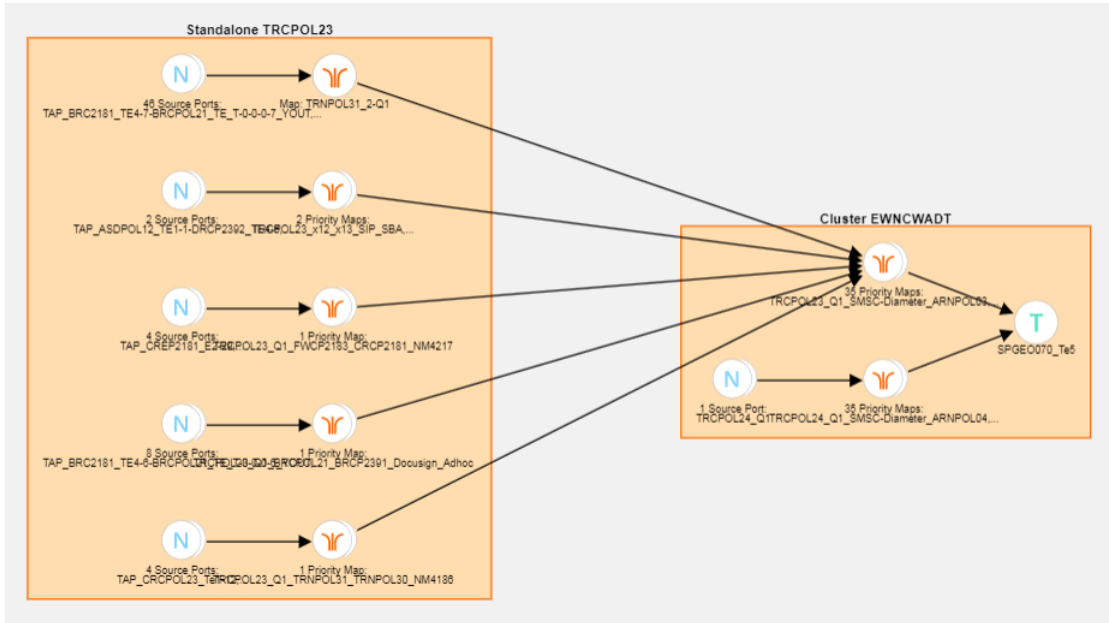


Figure 163: Flow - All Sites

Figure 164: Standalone GigaVUE Nodes shows a number of GigaVUE nodes in the Topology page that are not connected to each other.

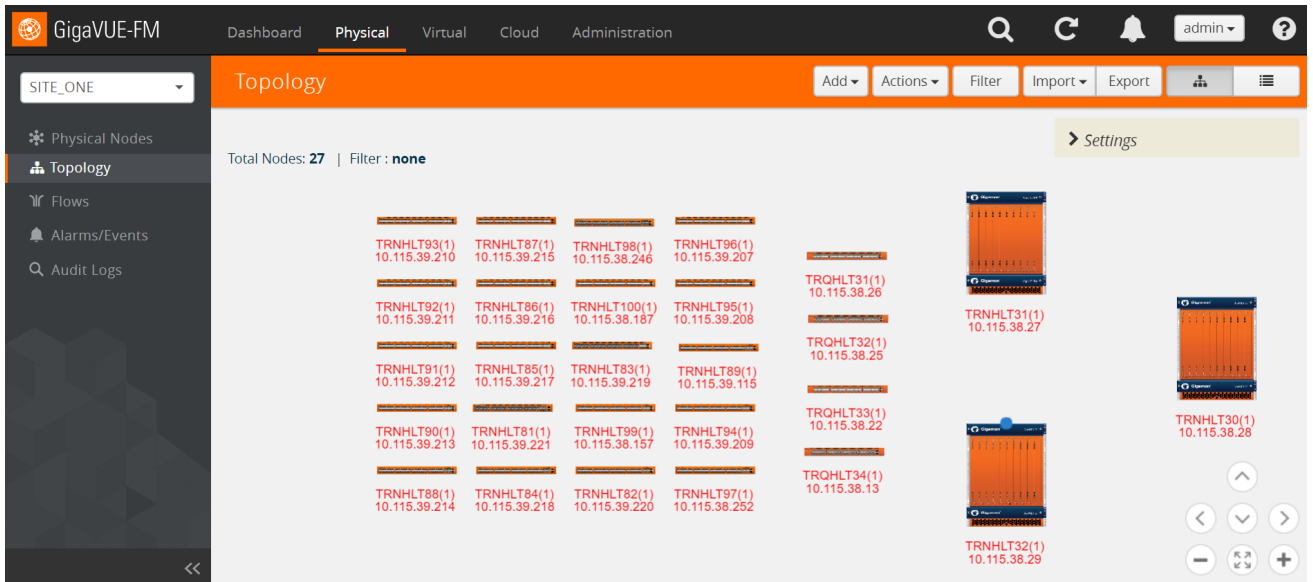


Figure 164: Standalone GigaVUE Nodes

Each node seen in [Figure 164: Standalone GigaVUE Nodes](#) is represented as a separate flow in the Flows page.

Flows - SITE_ONE Actions

Total Flows: **33**

<input type="checkbox"/>	Name	Status	Total Ports	Total Unhealthy Ports	Total Maps	Total Unhealthy Maps
<input type="checkbox"/>	TRQHLT31_TRNFHLT32	● Flow is healthy	12	0	10	0
<input type="checkbox"/>	TRNHLT87_TRQHLT31-34	● Flow is healthy	36	0	2	0
<input type="checkbox"/>	DAMHLT_Te1&Tel2	● Flow is healthy	9	0	1	0
<input type="checkbox"/>	TRNHLT94_TRQHLT31-34	● Flow is healthy	36	0	2	0
<input type="checkbox"/>	TRNHLT88_TRQHLT31-34	● Flow is healthy	36	0	2	0
<input type="checkbox"/>	TRNHLT90_TRQHLT31-34	● Flow is healthy	36	0	2	0
<input type="checkbox"/>	TRNHLT85_TRQHLT31-34	● Flow is healthy	36	0	2	0
<input type="checkbox"/>	TRNHLT93_TRQHLT31-34	● Flow is healthy	36	0	2	0
<input type="checkbox"/>	TRQHLT32_TRNFHLT32	● Flow is healthy	12	0	10	0

Figure 165: Flows Representing the Standalone Nodes

When those GigaVUE nodes are connected using manual links or Gigamon Discovery links, the number of flows created depends on the number of egress tool ports sending the traffic out to tools. In this example, three flows are created as shown in [Figure 164: Standalone GigaVUE Nodes](#).

Flows - All Sites							Actions
Total Flows: 3							
<input type="checkbox"/>	Name	Status	Total Ports	Total Unhealthy Ports	Total Maps	Total Unhealthy Maps	
<input type="checkbox"/>	DAMHLT_Te1&Tel2	● Maps [TRNHLT81_1Q1Q2_TRNHLT31_1Q7Q8_GTP-DCPCF001, TRNHLT81_1Q1Q2_TRNHLT31_1Q7Q8_Permanent] in the flow are unhealthy	843	2	125	2	
<input type="checkbox"/>	DAMHLT02_Te1	● Maps [TRNHLT81_1Q1Q2_TRNHLT31_1Q7Q8_GTP-DCPCF001, TRNHLT81_1Q1Q2_TRNHLT31_1Q7Q8_Permanent] in the flow are unhealthy	426	2	63	2	
<input type="checkbox"/>	DAMHLT01_Te1	● Flow is healthy	426	0	63	0	

Figure 166: Healthy Flows - sample illustration of flows after connections are made

NOTE: Gigamon Discovery is supported only from GigaVUE-FM 5.2 and above.

Figure 172: Unhealthy priority Maps shows how unhealthy priority maps are illustrated in a flow view page.

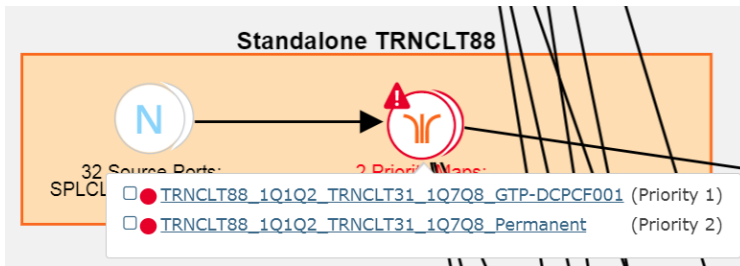


Figure 167: Unhealthy Maps

Using flows, you can perform the following:

- Quickly identify the maps and ports that are unhealthy.
- Quickly drill down the unhealthy map to investigate the cause of failure.
- Export a list of unhealthy ports and maps.
- View the data traffic across the flow, starting from the egress tool port that sends the traffic to the monitoring tool to the ingress network ports that receives the traffic from the network taps or span/mirror ports. The arrows in the flow indicate the path of the traffic flow.
- View the pass all maps and the priority maps. A priority map set contains multiple maps configured with the same source ports in the port list.
- Select multiple maps and view the statistics to verify if the traffic is flowing as expected.
- Filter flows by Flow Name, Status or Cluster ID.

- Update flows for the selected site.

A flow is automatically constructed every 24 hours, and flow health is calculated every 5 minutes. You can also manually trigger flow and graph calculations on demand.

The following components affect the health of a flow:

- Manual links or Gigamon Discovery links that connect the GigaVUE nodes.
- Maps that are participating in the flow.
- Health status of all the underlying components of a map such as GigaStream, port group, GigaSMART group, and vport.

For information on flow health status, refer to [Flow Health Status](#). For instructions on updating flows, see [How to Update Flows](#).

A flow can be viewed per site. All the nodes participating in the flow must belong to the same site.

View Flows

To view a flow:

1. Click **Physical** in the top navigation bar.
2. (Optional) From the sites drop-down box, select a site.
3. In the left navigation pane, click **Flows**.

The Flows page provides a summary of the flow name, cluster, host name, status, total ports, total unhealthy ports, total maps, total unhealthy maps and last computed time.

Table 21: Flows Summary Page

Option	Description
Name	Name of the flow.
Cluster	Where a specific flow is ending. Cluster ID
Host Name	Host name of the cluster.
Status	The Health status of the flow.
Total Ports	The total number of ports involved in the flow are displayed in the Total Ports link.
Unhealthy Ports	Total number of ports that are unhealthy. If there are unhealthy ports, click the Unhealthy Ports link to view the related ports that are unhealthy.

Option	Description
Total Maps	Total number of maps participating in the flow. Click the Related Maps link to view the related maps in the flow.
Unhealthy Maps	Total number of maps that are unhealthy. If there are unhealthy maps, click the Unhealthy Maps link to view the related maps that are unhealthy.
Last Computed Time	

- Click the numbers under Total Ports, Total Unhealthy Ports, Total Maps, and Total Unhealthy Maps to view detailed information about the maps and ports participating in the flow. Refer to [View Maps and Ports](#).
- To open a flow, select a flow and click **Actions > Open Flow**. Alternatively, click a flow.

View the Flow Summary and Statistics

A flow can display all maps that are created for managing the packet distribution in the GigaVUE nodes. A flow summary provides information only about the total number of maps and ports participating in the flow along with the total number of unhealthy maps and ports in the flow. You can also select multiple maps and view the statistics to check how exactly the packets are flowing.

To view the flow summary:

- Follow steps 1 to 3 as described in [View Flows](#).
- In the Flows page, click a flow that you want to view. Alternatively, select a flow and click **Actions > Open Flow**. The flow view page is displayed.

The following table describes the information provided in the Summary tab:

Table 22: Flow Summary

Option	Description
Related Ports	Total number of ports participating in the flow. Click the Related Ports link to view the related ports in the flow. Refer to View Total Ports . NOTE: V ports and GigaSMART ports are not considered.
Unhealthy Ports	Total number of related ports that are unhealthy.

Option	Description
	<p>If there are unhealthy ports, click the Unhealthy Ports link to view the related ports that are unhealthy. Refer to View Total Unhealthy Ports.</p> <p>To know more about how the health of a port is calculated, refer to Port Health Status.</p>
Related Maps	<p>Total number of maps participating in the flow.</p> <p>Click the Related Maps link to view the related maps in the flow. Refer to View Total Maps.</p>
Unhealthy Maps	<p>Total number of related maps that are unhealthy.</p> <p>If there are unhealthy maps, click the Unhealthy Maps link to view the related maps that are unhealthy. Refer to View Unhealthy Maps.</p> <p>To know more about how the health of a map is calculated, refer to Map Health Status.</p>

3. To view the statistics, select the maps. To select the maps, follow one of the following methods:

Method 1:

a. Click on a map. A list of priority maps are displayed. Refer to [Figure 168: Selecting Maps From Maps List](#).

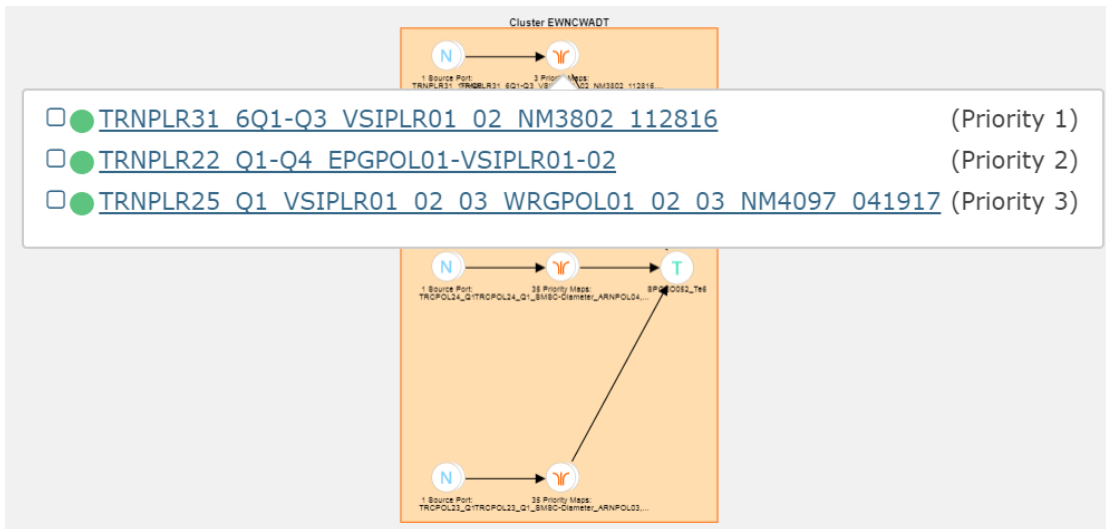


Figure 168: Selecting Maps From Maps List

b. Click the check box next to the priority map. The selected map is displayed in the **Items Selected** pop-up. Refer to [Figure 169: Selected Maps in Items Selected Pop-up](#).

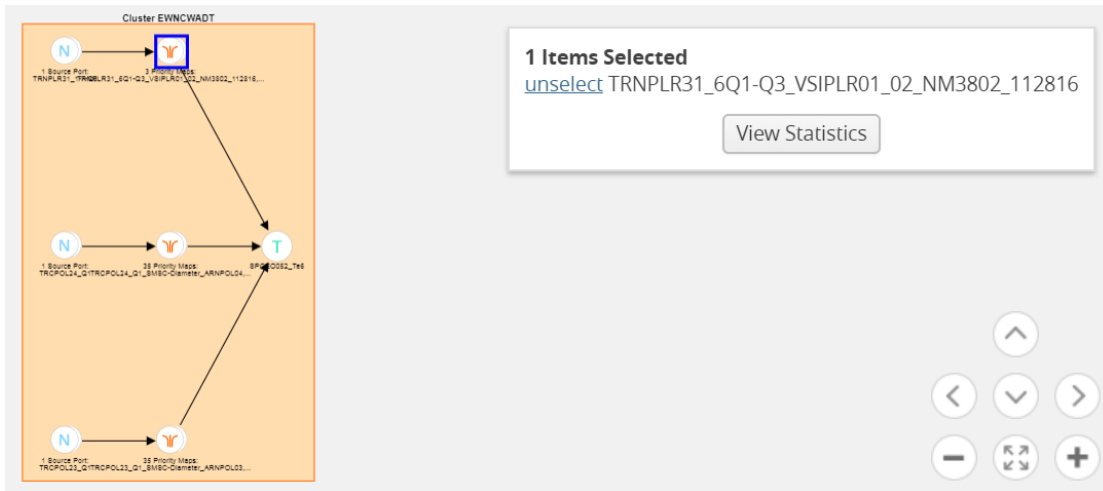


Figure 169: Selected Maps in Items Selected Pop-up

- c. Repeat step a and b for selecting multiple maps.

Method 2:

- a. In the flow view page, double-click on a map. A list of priority maps are displayed. Refer to [Figure 170: List of Priority Maps](#).



Figure 170: List of Priority Maps

- b. Click on a map. The map is selected and is simultaneously displayed in the **Items Selected** pop-up. Refer to [Figure 171: Maps Selected](#).

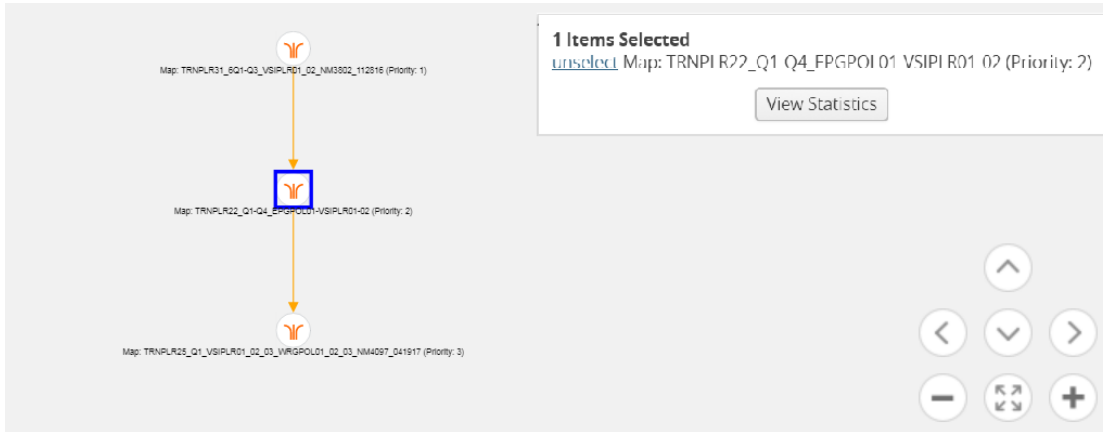


Figure 171: Maps Selected

- c. Repeat step b to select multiple maps.
4. In the **Items Selected** pop-up, click **View Statistics**. Alternatively, select the **Statistics** tab and click **View Statistics**. The **Statistics** tab displays a graph to show how the packets are flowing from the selected maps.

View Maps and Ports

Figure 172: Unhealthy priority Maps shows how unhealthy priority maps are illustrated in a flow view page.

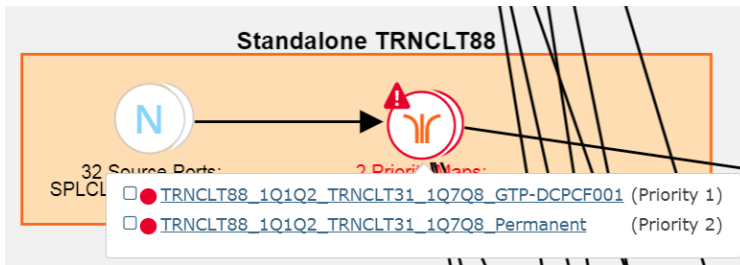


Figure 172: Unhealthy priority Maps

Figure 173: Unhealthy Pass-all Map shows how a pass-all map is illustrated in a flow view page.

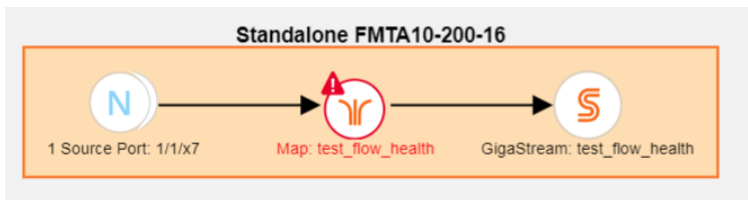


Figure 173: Unhealthy Pass-all Map

A priority map set as illustrated in [Figure 172: Unhealthy priority Maps](#) can contain one or more maps configured with the same source ports. The health of this map is determined by the aggregated health of the priority maps in the map set. Sometimes, this map might be unhealthy because a map that is not participating in the flow is unhealthy. The overall health status of a flow is determined based on the aggregated health of all the maps that are involved in the flow.

There are two ways to view the total number of maps and ports that are healthy and unhealthy.

- In the Flows page, click the total number of ports, unhealthy ports, total maps, and total unhealthy maps to view detailed information about the maps and ports involved in the respective flow.
- Click a flow in the Flows page. In the Summary tab, click the Related Ports, Total Unhealthy Ports, Related Maps, and Total Unhealthy Maps links to view detailed information about the maps and ports involved in the selected flow.

View Total Ports

The total number of ports involved in the flow are displayed in the Total Ports link.

To view the total ports involved in the flow:

1. In the Flows page, click the **Total Ports** link. The All Ports quick view displays a list of all ports that are involved in the flow. It also provides information such as port ID or alias, type, port health status, and the node on which the port is configured.
2. In the All Ports quick view, click a Port ID to open the Port quick view.
3. To return to the All Ports quick view, click **Back**.
4. In the All Ports quick view, click a node under the Node column to open the Overview page.

View Total Unhealthy Ports

The total number of unhealthy ports involved in the flow are displayed in the Total Unhealthy Ports link.

To view the unhealthy ports:

1. In the Flows page, click the **Total Unhealthy Ports** link. The Unhealthy Ports quick view displays a list of unhealthy ports that are involved in the flow. It also provides information such as port ID or alias, type, port health status, and the node on which the port is configured.
2. In the Unhealthy Ports quick view, click a Port ID to open the Port quick view.
3. Click a node under the Node column to open the node's Overview page.

View Total Maps

The total number of maps involved in the flow are displayed in the Total Maps link.

1. In the Flows page, click the **Total Maps** link. The All Maps quick view displays a list of all maps that are involved in the flow. It also provides information such as map ID or alias, type, map health status, and the priority node on which the map is configured. Refer to [Figure 174: Flow - All Maps](#).

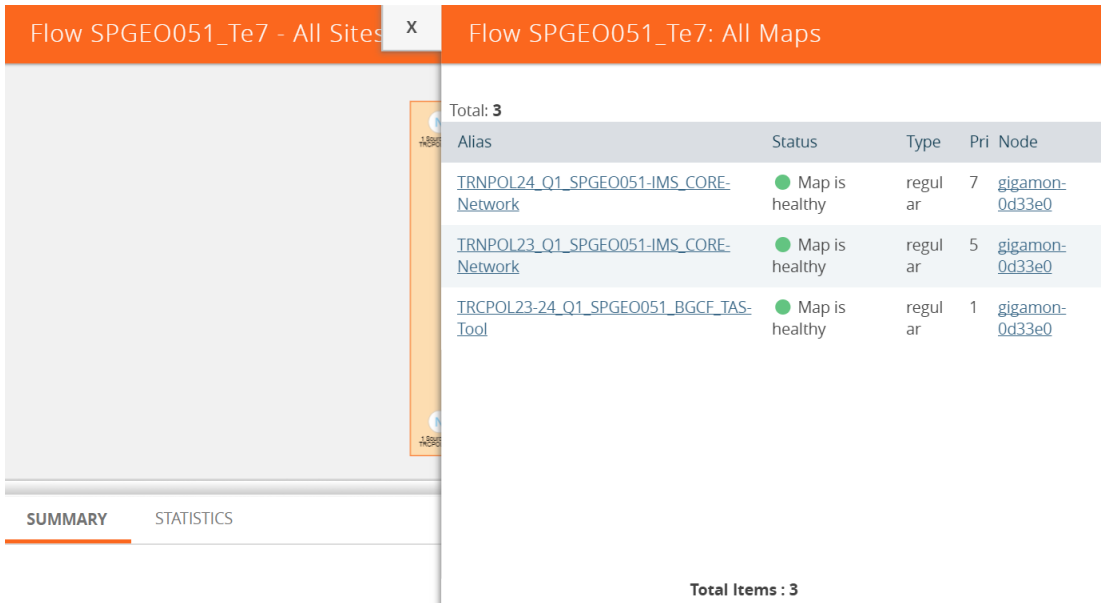


Figure 174: Flow - All Maps

2. In the All Maps quick view, click a Map alias to open the Map quick view. Refer to [Figure 175: Flows - Map Quick View](#).

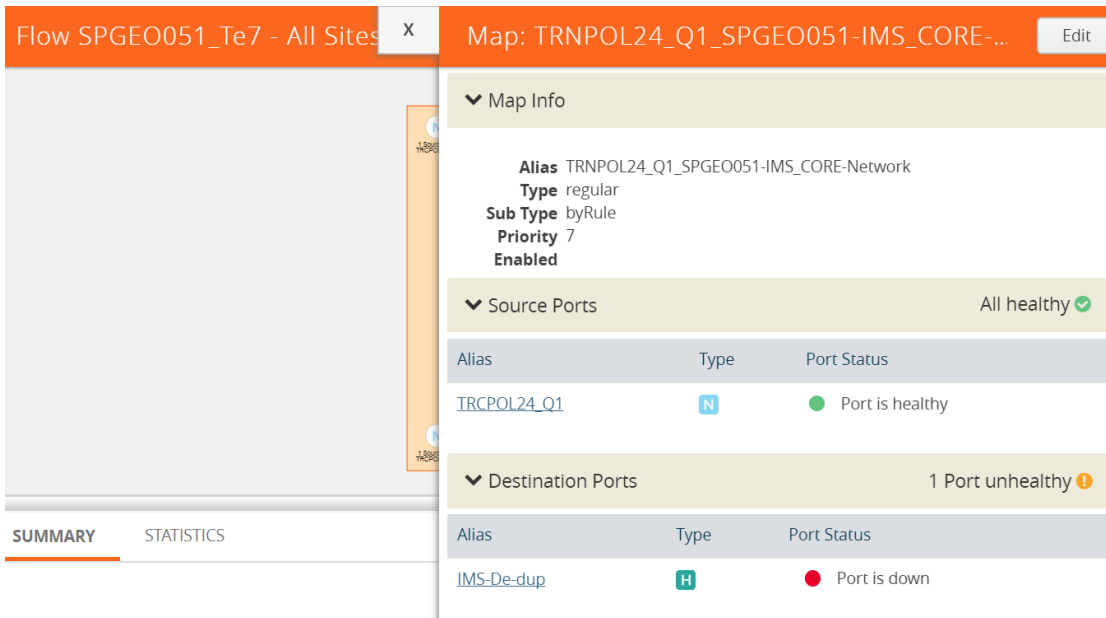


Figure 175: Flows - Map Quick View

View Unhealthy Maps

The total number of unhealthy maps involved in the flow are displayed in the Total Unhealthy Maps link.

In the Flows page, click the **Total Unhealthy Maps** link.

The Unhealthy Maps quick view displays a list of all unhealthy maps that are involved in the flow. It also provides information such as map alias, type, map health status, and the priority node on which the map is configured. Refer to [Figure 176: Flow - Unhealthy Maps](#).

Alias	Status	Type	Priority	Node
mapfor demo	Ports ConnectedPacketcapture are link down	regular	1	EMHB1-200-80

Figure 176: Flow - Unhealthy Maps

In the Unhealthy Maps quick view you can:

- Click **Export** to export an Excel report listing the unhealthy maps.
- Click a map alias link in the Alias column to open the Map quick view. Refer to [Figure 175: Flows - Map Quick View](#).
- Click a node under the Node column to open the Overview page.

Filter Flows

To filter flows by name, do the following:

1. Click **Physical** in the top navigation bar.
2. (Optional) From the sites drop-down box, select a site.
3. In the left navigation pane, click **Flows**. The Flows page is displayed.

- Click the **Filter** button at the top of the pane. The Filter panel displays.

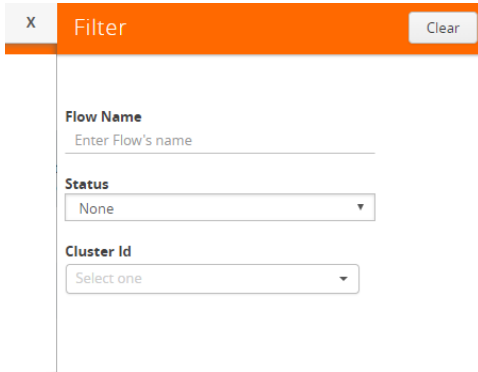


Figure 177: Flow Filter Pane

- Start typing the first few characters of the name of a flow you wish to filter on. The flow list is sorted and all the flows containing the characters you entered displays in order at the top on the page.

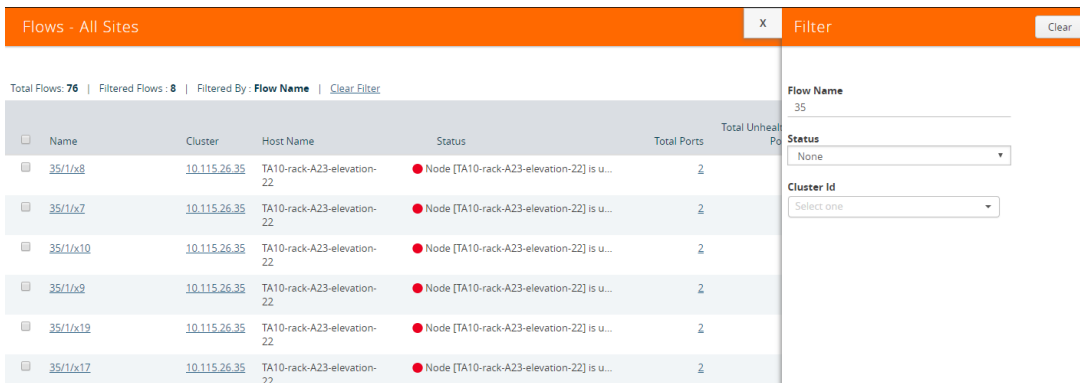


Figure 178: Flow Filter - Names

To filter flows based on their status:

- Click the **Status** drop down and select one of the Status colors to display only those flows that correspond to the color selected.

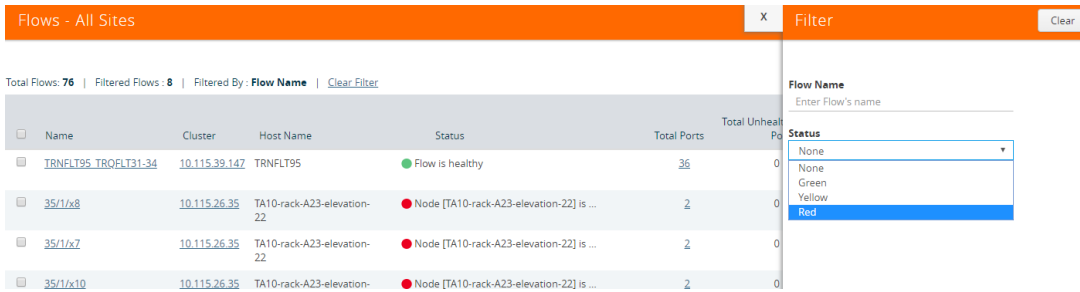


Figure 179: Flow Filter - Status

To filter flows based on the Cluster ID:

- Click the **Cluster ID** drop down and select one of the Cluster IDs to display only those flows that correspond to the Cluster ID you selected.

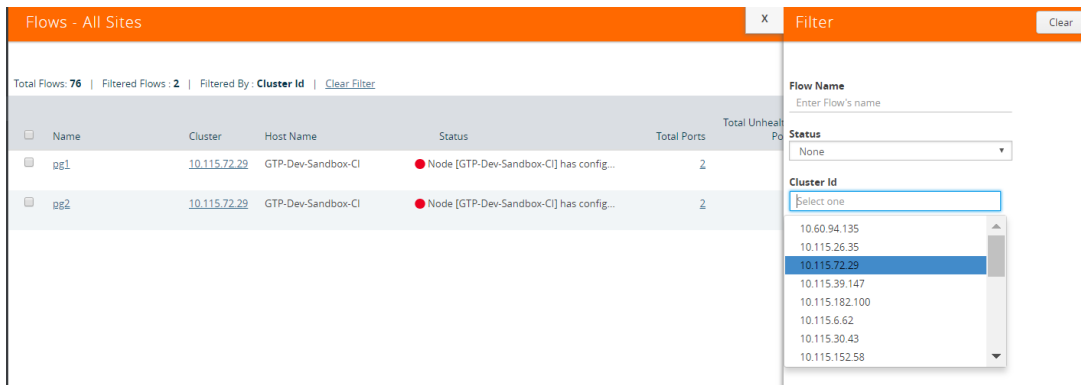


Figure 180: Flow Filter - Cluster ID

How to Change the Flow Layout

By default, a flow layout is arranged in a directional flow. The ingress network port receiving the traffic from the network TAP is aligned to the left and the tool port sending the traffic to the monitoring tool is aligned to the right. The maps configured on the standalone nodes and clusters are displayed within the respective containers. The arrows in the layout shows the direction in which the packets are moving from network ports to tool ports. You can drag and drop the cluster or node containers to change the alignment. You can also drag and drop the ports and maps within the container to change the layout.

To reset, save, or restore the layout:

- In the Flow view page, click and drag a port or a map to change the layout as desired.
- To save the new flow layout, click **Actions > Save current layout**. The current alignment of the flow is saved.

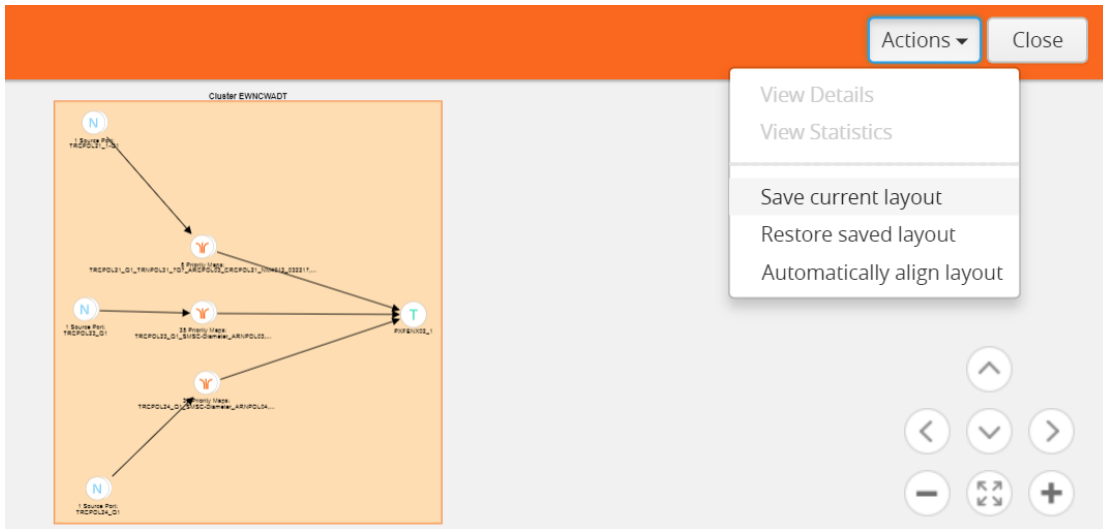


Figure 181: Save Current Layout

3. To align the layout to default, click **Actions > Automatically align layout**. The layout is automatically set to the default.

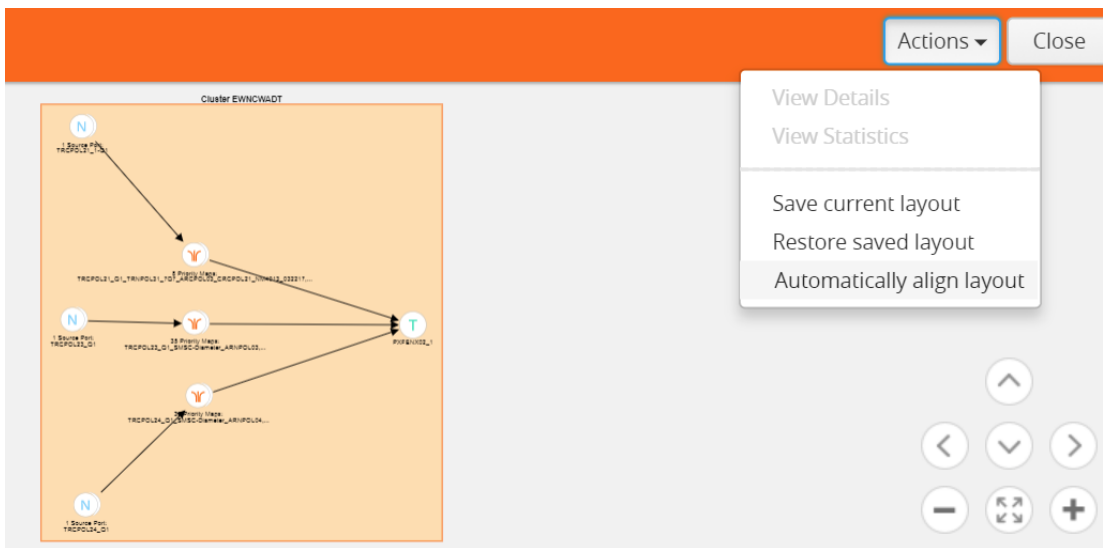


Figure 182: Automatically Align to Default Layout

4. To restore the saved layout, click **Actions > Restore saved layout**.

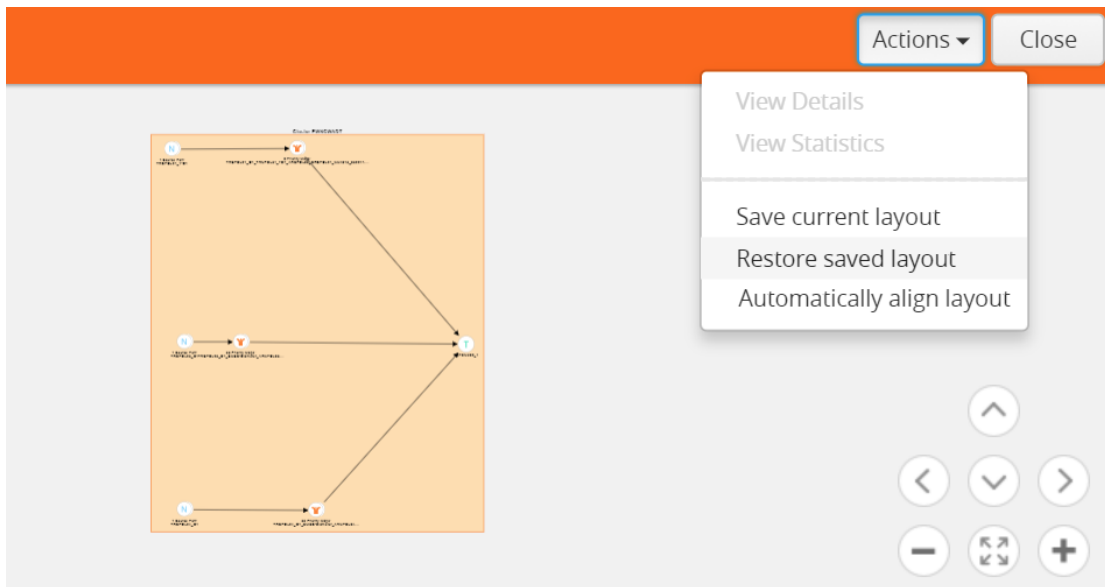


Figure 183: Restore to Saved Layout

How to Update Flows

Flows are computed based on the Gigamon discovery or manual links connecting the GigaVUE nodes and the maps participating in the flow. The changes made to the flow are not seen unless they are automatically updated after every 24 hours or manually updated from the Flows page. In release 5.3, flows can be updated

NOTE: It is recommended to update flows on a per-site basis for best results. If you update flows without selecting a site, the action will update all flows across all sites, which will take a very long time and is not a recommended practice. Refer to [Update Flows for a Selected Site](#).

To manually update a flow:

1. Click **Physical** in the top navigation bar.
2. (Optional) From the sites drop-down box, select a site.
3. In the left navigation pane, click **Flows**. The Flows page is displayed.

Important: if you update flows without selecting a site, all flows across all sites will be updated, which will take a long time. This is supported but is not recommended. To update a flows on a per-site bases, refer to [Update Flows for a Selected Site](#).

4. Click **Actions** > **Update**. A message is displayed to indicate that the flow calculation is in progress. The check boxes to select a flow disappear when the flow is being updated. They slowly start appearing when the update is completed for that particular flow.

Flows - SITE_ONE						
Total Flows: 33						
Name	Status	Total Ports	Total Unhealthy Ports	Total Maps	Total Unhealthy Maps	
TRQHLT31_TRNFHLT32	● Flow is healthy	12	0	10	0	
TRNHLT87_TRQHLT31-34	● Flow is healthy Flow detail calculation in progress...	36	0	2	0	
DAMHLT_Te1&Tel2	● Flow is healthy	9	0	1	0	
TRNHLT82_TRQHLT31-34	● Maps [TRNHLT82_1Q1Q2_TRNHLT31_1Q7Q8_GTP-DCPCF001, TRNHLT82_1Q1Q2_TRNHLT31_1Q7Q8_Permanent] in the flow are unhealthy	36	4	2	2	
TRNHLT94_TRQHLT31-34	● Flow is healthy	36	0	2	0	
TRNHLT88_TRQHLT31-34	● Flow is healthy	36	0	2	0	

NOTE: All components of a flow must belong to the same site. If a GigaVUE node does not belong to the same site as compared to the node connected to the tools, then an error message is displayed.

Update Flows for a Selected Site

This process shows how to update flows on a per-site basis. This is the recommended method for updating flows.

Flows are automatically updated every 24 hours or can be manually triggered if you believe the underlying components have changed, such as map source or destination ports, GDP links or manual links. The following steps describe how to perform a manual update at a specific site.

To manually update flows for a selected site, do the following:

1. Click **Physical** in the top navigation bar.
2. From the sites drop-down box, select a site where you wish to update the flows.

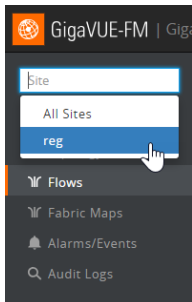


Figure 184: Updating Flows - Selecting Specific Sites

3. Click the Update link under the action menu drop down in the right corner of the screen.

The flows you selected are updated and the **Last Compute Time** column displays the time and date of the update.

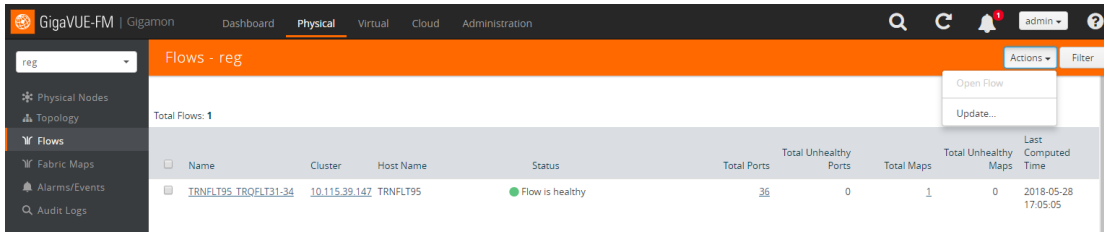


Figure 185: Updating Flows - Specific Sites

View Events

On the Events page, the FlowHealthStateChange event type indicates that there is a change in the health status of a flow. For more information about Events, refer to the “Events” section in the *GigaVUE-OS and GigaVUE-FM Administration Guide*.

Refer to [Figure 186: Flow Health Event Type](#) for the flow health change event on the **Events** page.

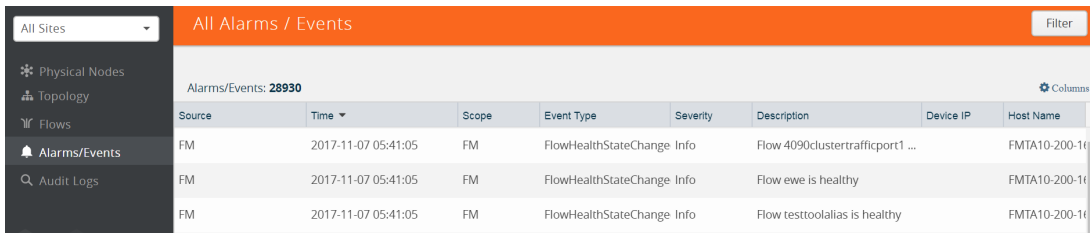


Figure 186: Flow Health Event Type

Set Notifications

On the Notifications page, the email notification for the **Flow Health State Changed** event type can be configured to automatically send emails to the specified addresses when there is a change in the health of any of the flows managed by GigaVUE-FM. For more information about configuring notifications, refer to the “Notifications” section in the *GigaVUE-OS and GigaVUE-FM Administration Guide*.

Refer to [Figure 187: Flow Health State Changed Notification](#) for the flow health state changed notification on the **Notifications** page.

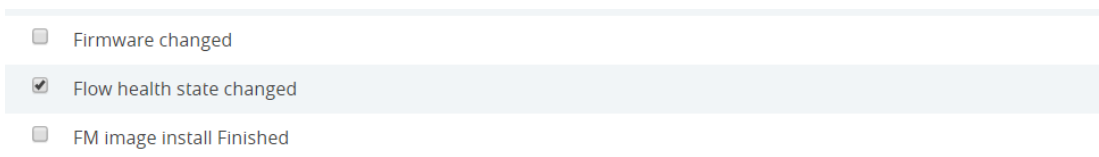


Figure 187: Flow Health State Changed Notification

Limitations of Flows

If Gigamon Discovery is enabled on GigaVUE nodes and a link is created between a source and a destination node that are of hybrid port types, the flow ends at the source node hybrid port. As hybrid port acts as an indirect traffic source port and as a tool port, the flow construction fails to identify the direction of the traffic flow. The workaround is to add a manual link to indicate the direction of the traffic flow.

Device Logs and Event Notifications

This chapter describes how to view the logs for the selected node.

Refer to the following sections:

- [Stream Device Logs to GigaVUE-FM](#)
- [View Device Logs](#)
- [Device Log Host Servers](#)
- [Storage Management for Device Logs](#)
- [Manage Device Log Output](#)
- [Device Event Notifications](#)

Stream Device Logs to GigaVUE-FM

GigaVUE H Series device/cluster nodes provide comprehensive logging capabilities to keep track of system activity. Logging is particularly useful for troubleshooting system issues, as well as maintaining an audit trail. You can specify what types of events are logged, view log records by priority, date, or name, and upload log files to a remote host for external troubleshooting.

When H Series devices are added to GigaVUE-FM, the default settings ensure that log records stream to the GigaVUE-FM server and are written on the device's file system in a messages file. Log records can be used to analyze the system behavior directly from the GigaVUE-FM interface instead of needing to sign in to each device.

External third-party servers can also be added to host the streamed logs. Refer to [Add an External Logging Host Server to a Node](#).

In this section:

- [Cluster Behavior](#)
- [Standardized Logs](#)
- [Device Log Categories](#)
- [Device Log Message Types](#)
- [Device Logging Levels](#)
- [Device Logging Processes](#)

Cluster Behavior

Logging configuration is local to the node. Each node has its own logging configuration.

Important: This is a different behavior than in software versions prior to 5.3 in which the logging configuration on the master node was synchronized to the other nodes in the cluster.

Standardized Logs

Standardized log messages can be streamed to GigaVUE-FM. The log messages follow the industry standard described in RFC5424. The format includes structured data, timestamp, version, and message ID. The timestamp includes milliseconds for increased accuracy.

In GigaVUE-FM, the log information is displayed in a table with configurable, sortable columns and extensive filter options.

Refer to [View Device Logs](#) for information about viewing and filtering logs in GigaVUE-FM.

Refer to the **GigaVUE-OS-CLI User's Guide** for information about the standardized log message format in the CLI view.

Device Log Categories

[Table 23: Device Log Categories](#) describes the categories in device/cluster log messages as per the standardized log format. Refer to [Standardized Logs](#) for standardization information.

Table 23: Device Log Categories

Message ID	Description
GENERAL-ERR	Errors that are common across applications
HIGH-TEMPERATURE	High Temperature
PACKETDROP	Packet Drop

Message ID	Description
LINK	Link
INIT	Initialization
RESOURCE-UTIL	Resource Utilization
REQUEST	Query system information

Device Log Message Types

[Table 24: Device Log Message Types](#) describes the message types in device/cluster log messages as per the standardized log format. Refer to [Standardized Logs](#) for standardization information.

Table 24: Device Log Message Types

Message ID	Description
memoryAllocError	Memory allocation error
memoryAccessError	Unexpected NULL access
fileAccessError	File access error
switchCpuHighTemperature	High Switch CPU Temperature
opticsHighTemperature	High Optics Temperature
gigasmartCpuHighTemperature	High GigaSMART CPU Temperature
ambientCpuHighTemperature	High Ambient CPU Temperature
exhaustCpuHighTemperature	High Exhaust CPU Temperature
egressPacketDrop	Packet Drop at Egress
ingressPacketDrop	Packet Drop at Ingress
linkChangeNotify	Link Change Notification
mgmtModule	Failed to load mgmt module
systemCpuUtil	High System CPU Utilization
systemMemoryUtil	High System Memory utilization

Message ID	Description
processCpuUtil	High CPU Consumption by a process
processMemoryUtil	High Memory Consumption by a process
processAccessError	Process access errors
systemAccessError	Process access errors
queryFail	Failed to fetch system data
moduleInitFail	Failed to load a cli module

Device Logging Levels

[Table 25: Logging Levels](#) shows the standard logging levels that are used to rank logged events by degree of severity. When configuring the device/cluster logs to stream, the highest severity level will capture fewer logs than the lowest severity. For example, if the lowest level (info or debug) is selected in your configuration, all levels of logs, from the selected level up to the highest level, will be streamed. If the highest level (emergency) is selected, only emergency logs will be streamed.

Table 25: Logging Levels

Log-Level	Description
emergency	Emergency – the system is unusable. The severity level with the least logging – only emergency level events/commands are logged.
alert	Action must be taken immediately.
critical	Critical conditions.
error	Error conditions.
warning	Warning conditions.
notice	Normal but significant condition.
info	Informational messages.
debug	Debug-level messages. Authorized for factory use only.

Device Logging Processes

Logs that are specific to a process are logged with the process ID. [Table 26: Logging Processes](#) provides a list of logging processes and their descriptions.

Table 26: Logging Processes

Logging Process	Description
acctd	AAA Accounting daemon
avd	Active Visibility daemon
cli	Command Line Interface
clusterd	Cluster daemon
debuggabilityd	Debuggability daemon
frm	Foreign Resource Manager
gsd	GigaSMART daemon
gprof	Profiler
httpd	HTTP daemon
licd	License daemon
mgmtd	Management daemon
ndiscd	Network Discovery daemon
netdevd	Netdev daemon
notif_mgr	Notification Manager
ntpd	Network Time Protocol daemon
peripd	Peripheral daemon
persistd	Persistence daemon
pm	Process Manager
ptpd	PTP Protocol daemon
restapid	REST API daemon
sched	Scheduler daemon
snmpd	SNMP daemon
statsd	Statistics daemon
syncd	Sync daemon
syslth	System Health
ugwd	Unified Gateway daemon
wizard	Wizard

Logging Process	Description
wsmd	Web session Manager daemon
xd	XML Gateway
xinetd	Extended Internet Service daemon

View Device Logs

GigaVUE-FM provides the ability to view logs for each device/cluster node. These logs list all the user events and enable Gigamon Technical Support to troubleshoot in case of any problems.

NOTE: Log streaming is supported on H Series devices only.

In addition to describing how to view logs, this section describes the following supported functionality related to understanding and configuring the Logs view.

- [Arrange Columns in the Logs View](#)

To view the logs of a single node:

1. Click **Physical** in the top navigation bar.
The Physical Nodes page displays the list of physical nodes managed by GigaVUE-FM.
2. Select a GigaVUE node.
The Single Node view displays overview statistics about the selected node.
3. In the left navigation pane, click **Logs**.

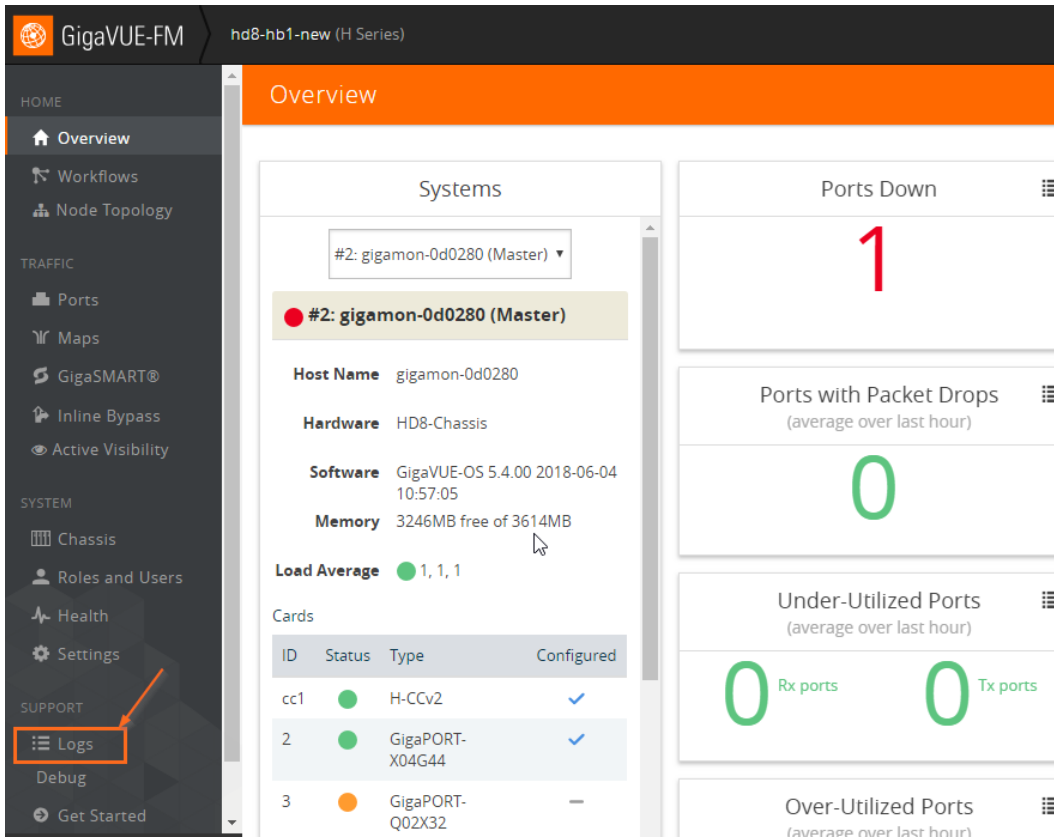


Figure 188: Overview of a Single Node

The Logs view displays the latest log information for the selected GigaVUE node in table format.

4. (Optional) Click the heading cell for any column to sort the list by that attribute. Refer to [Arrange Columns in the Logs View](#) for details.
5. (Optional) Click **Filter** to refine the list of logs by any of the available attributes. The Filter quick view displays the attributes of the logs.
 - a. Enter a value in any of the available attribute fields to narrow the list of logs according to that value.

Filterable Attributes	Description
Host Name	Enter a hostname or partial host name.
Device IP	Enter a device IP address or partial address.
Time	Specify a start date and time and an end date and time to define a time period. IMPORTANT: Timestamps are shown in the time zone of the

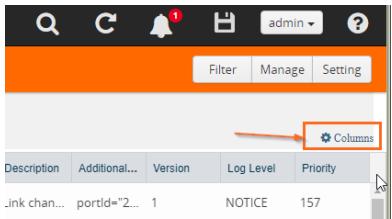
Filterable Attributes	Description
	client browser's computer and not the timezone of the node reporting the event. The timestamp is based on the correctly configured clock on the GigaVUE-FM server and converted from UTC to the client computer's configured timezone.
Process	Specify a process to target, such as clusterd, httpd, ntpd, restapid, snmpd, sshd, ugw, or wsmd. Partial text entries are acceptable. Refer to Device Logging Processes
Log Level	Select one from the list of log levels, which are ranked by degree of severity. Refer to Device Logging Levels .
Category	Select a category of issue from the list of values, such as: High Temperature, Link, Packet Drop, or Resource Utilization. Refer to Device Log Categories .
Priority	Enter a priority number as defined by RFC 5424.
Version	Enter a version number.
Type	Select an event type from the list of values, such as CPU utilization high, memory utilization high, egress or ingress packet drop, and so on. Refer to Device Log Message Types .
Affected Entity Type	Select an affected entity type from the list of values. Options are: CPU, Memory, Port, or Optics
Affected Entity	Enter a specific affected entity

- b. Click **Apply Filter** to apply the filter on the current list of logs.
The list of logs is now limited to the set matching your filter criteria.
- c. To clear the filter, click the "Clear Filter" link above the table.

Arrange Columns in the Logs View

The Logs view has sortable, configurable columns. The options below describe how to use these options to personalize your view of the logs:

- Click the heading cell for any column to sort the list by that attribute.
- To move the order of a column, click the heading cell for that column and drag it to the location you prefer, then release the mouse click to drop it in the new location.
- Configure the columns to display in this view:
 - a. Click **Columns** on the right above the table.



b. The COLUMNS window appears.

c. Amend your column settings:

To remove a column, select the column label in the selected columns table and click **Remove**.

To add a column, select the column label in the Available Columns table and click **Add**.

To resort the order in which the columns appear, select any label and click **Move Up** or **Move Down** to reposition the column.

To revert to the GigaVUE-FM default setting, click **Reset to Defaults**.

d. When you are done configuring the columns, click **OK**.

Device Log Host Servers

All device/cluster log messages for all H Series nodes are streamed to the GigaVUE-FM server by default and are written on the device's file system in a messages file.

External third-party servers, like Splunk, can be added to host the streamed logs. You may want to have certain types of log messages streamed to different servers for different purposes. The Log Settings enable you to add additional host servers for the log streams and to configure the type of logs each server will host.

When an external server is specified, the GigaVUE H Series node will send logged events through UDP, TCP, or SSH to the specified destination.

In this section:

- [Add an External Logging Host Server to a Node](#)
- [Edit Host Server Settings](#)

NOTE: For a description of log levels, refer to [Logging Levels](#). For a description of Syslog Server configuration options, refer to [Host Server Options](#).

Add an External Logging Host Server to a Node

This topic describes how to configure a system log server as a destination for logging in GigaVUE-FM.

To add a host server:

1. Navigate to **Physical Nodes** and select a node.
2. Click **Logs** from the Single Node view.
3. Click **Settings**.

The Log Settings view appears.

4. Click **Add Server**.

The Add Log Server quick view appears.

5. Specify the server attributes of the log server you wish to add. The parameters vary based on the protocol you select.

Select the logging protocol: **UDP (default)**, **TCP**, or **SSH**.

For **UDP**, do the following:

- a. Enter the external server's IP address in the **IP Address** field.
- b. Select the logging level from the **Log Level** list. For a description of the logging levels, refer to [Logging Levels](#).

For **TCP**, do the following:

- a. Enter the external server's IP address in the **IP Address** field.
- b. Select the logging level from the **Log Level** list. For a description of the logging levels, refer to [Logging Levels](#).
- c. Enter the port number in the **Port** field.

For **SSH**, do the following:

- a. Enter the external server's IP address in the **IP Address** field.
- b. Select the logging level from the **Log Level** list. For a description of the logging levels, refer to [Logging Levels](#).
- c. Enter the port number in the TCP Port field.

6. Click **OK** to save the settings and add the server.

The additional server appears in the server list.

7. Specify the optional settings for the server. Refer to [Host Server Options](#) for a description of the options.
8. Click **OK** to save the settings.

Host Server Options

The following table describes the optional host server settings for device logs.

Table 27: Syslog Server Settings

Setting	Description
Logging	<p>This option enables or disable the server.</p> <ul style="list-style-type: none"> • Click Enable to enable the server. (Default) • Click Disabled to disable the server. • Click Delete to remove the server from this node.
Server Log Level	<p>Select the level of alert you wish to tack on this server:</p> <ul style="list-style-type: none"> • Info • Notice • Warning (default) • Error • Alert • Critical • Emergency <div style="border: 1px solid #ccc; padding: 5px; margin-top: 10px;"> <p>NOTE: Refer to Device Logging Levels.</p> </div>
Protocol	<p>Select the protocol for communicating with this server:</p> <ul style="list-style-type: none"> • TCP • UDP (default) <div style="border: 1px solid #ccc; padding: 5px; margin-top: 10px;"> <p>NOTE: GigaVUE-FM can receive logs in TCP as well as UDP on port 5672. However by default it is UDP.</p> </div>
Port	Enter the Port Number.
Ssh Enabled	Check the Ssh Enabled check box to enable Ssh on this server.

Edit Host Server Settings

To edit log settings:

1. Navigate to **Physical Nodes** and select a node.
2. Click **Logs** from the Single Node view.
3. Click **Settings**.

The Log Settings view appears.

The top portion of the Logs Setting page shows the global Storage Management settings. The table in the lower portion lists the servers

4. Edit the settings for the server directly in the server list table. Refer to [Host Server Options](#) for a description of the options.
5. Click **OK** to save the settings.

Storage Management for Device Logs

Device/cluster log messages for H Series nodes in GigaVUE-FM are continuously being recorded. As a result, the logs can take up a lot of storage space over time. You may want to delete old records on a regular basis to clear-up storage space. You may want to export log records as a back-up before performing a delete operation or to preserve for external analysis.

GigaVUE-FM Storage Management allows you to define how the stored logs are managed. You can specify a schedule for purging old device logs. You can also specify an SFTP server to export the log records prior to purging.

NOTE: GigaVUE-FM Storage Management is used for all storage settings, including device logs, alarm/event notifications, and statistics. This topic, however, describes the storage management for device logs, in particular.

Access Storage Management

There are two ways to access the Storage Management settings for device logs. Aside from the path, the instructions are the same. Both paths allow you define the settings across nodes. Neither setting allows you to define device-specific storage settings. These paths are described in [Accessing Storage Management](#) .

Table 28: Accessing Storage Management

Path

Click  GigaVUE-OS and GigaVUE-FM Administration Guide.

Path

Click **Physical** on the top navigation bar and select **Physical Nodes** from the left navigation pane. Select a node, then select **Logs > Settings**. From the Log Settings page, click the "Edit" link next to the export or delete setting summary.

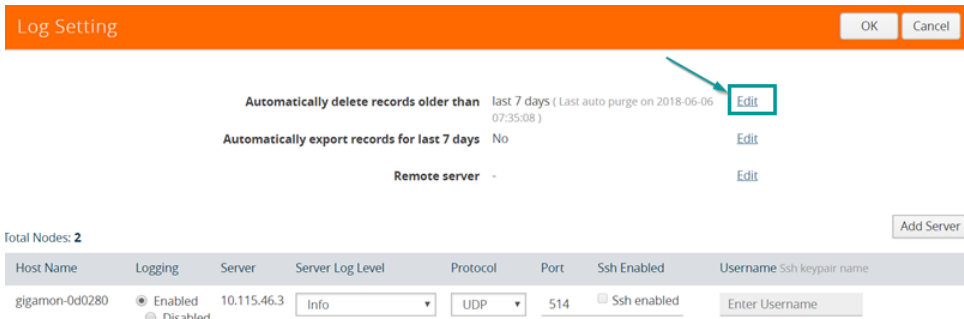
NOTE: To perform a one-time manual clean-up of old logs on a specific node, refer to [Manage Device Log Output](#).

To access Storage Management settings from the node's Logs page:

1. Click **Physical** on the top navigation bar and select **Physical Nodes** from the left navigation pane.
2. Select a node.
3. Click **Logs** from the left navigation pane in the node view.
4. Click **Settings**.

The Log Settings view appears.

5. To edit the Storage Management settings for the device logs, click the "Edit" link next to the export or delete setting:



The Storage Management page under Administration appears.

NOTE: This setting is not node-specific. This setting applies to all logs in GigaVUE-FM across devices. Refer to the "Storage Management" section in the *GigaVUE-OS and GigaVUE-FM Administration Guide*.

Manage Device Log Output

Log management allows you to export and delete logs that are stored in GigaVUE-FM. Use this process to manually clean-up old logs on a specific node before a specified cut-off date and time. You can also specify an SFTP server and file path to export the records prior to purging.

NOTE: Refer to [Storage Management for Device Logs](#) for global Storage Management settings that control purging of old logs on a scheduled basis across all devices.

To edit the log management settings:

1. Navigate to **Physical Nodes** and select a node.
2. Click **Logs** from the node view.
3. Click **Manage**.
The Manage Logs view appears.
4. Complete the fields on this page to specify how to manage the logs:

Setting	Description
Time Range	
Select records older than	Specify a cut-off date and time for deleting log records. Log records that were created prior to the specified date and time will be deleted. The time is based on the current timezone in GigaVUE-FM.
Export Records To	
SFTP Server Address	The records are exported to a CSV file. Specify the ftp/sftp location to send the CSV files. For example: sftp://username@121.0.0.1/path/directory
Username and Password	If this is a secure server, which is recommended, specify the username and password for accessing the server.
File Path	Specify the path on the server to store the file. For example: /root/dir/archive.zip
Purge Selected Records	
Check this check box to enable purging the selected records. Important: If this option is selected, records will be deleted immediately when you click OK .	

5. Click **OK** to save the settings.

Device Event Notifications

Events can be streamed to GigaVUE-FM. Each device (GigaVUE node) can directly stream events. In software version 5.3, the following events are transmitted:

- port up and port down
- GigaSMART packet drops
- GigaSMART application core crash when a back trace trigger is initiated
- GigaSMART application core crash when a soft reset is initiated
- CPU utilization in the GigaSMART cores when the high threshold is exceeded

NOTE: The events described in this section are not SNMP traps.

Cluster Limitation

Event Notifications require that network connectivity be available from each node in the cluster to its managing GigaVUE-FM, not just to the master node.

Configure Device Event Notifications

When H Series devices are added to GigaVUE-FM, GigaVUE-FM is added as a notification target on the attached device. This ensures that event notifications from the device stream to the GigaVUE-FM server. The events that are streamed are stored in the GigaVUE-FM database, and are available for querying using the filters in the Events page. Refer to the “Events” section in the *GigaVUE-OS and GigaVUE-FM Administration Guide*.

A list of the configured event notification targets for the device/cluster can be seen on the Event Notification page in the physical node settings. To access this page, click **Physical** on the top navigation bar. On the left navigation pane, select **Physical Nodes**. Double-click on a node ID to open it. From the node, navigate to **Settings > Global Settings > Event Notification**.

The Event Notification page lists all target hosts for Alarm/Event notifications from this device/cluster. This page allows you to control (enable/disable) whether a target host receives notifications from this device/cluster. You can also view the Alarm/Event purge and export settings defined under Storage Management.

To manage notifications for a device/cluster:

1. Select **Physical > Physical Nodes**.
2. Click a Cluster ID link to open the node.

- From the node, navigate to **Settings > Global Settings > Event Notification**.

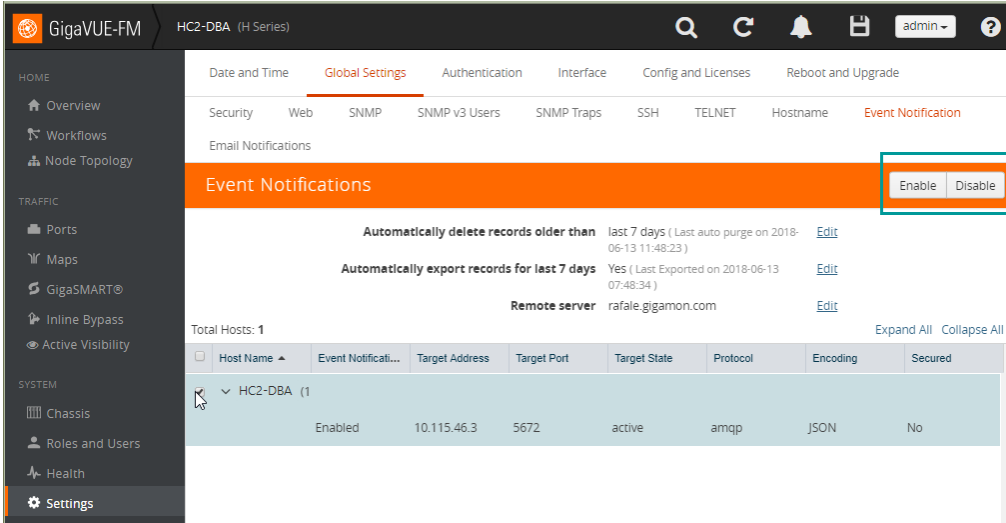


Figure 189: Device/Cluster Event Notification Settings

Storage Management settings for all system events are summarized above the table.

- To access Storage Management settings for all system events:
 - Click the “Edit” link next to any of the summary purge and export settings.
 - Refer to the “Storage Management” section in the *GigaVUE-OS and GigaVUE-FM Administration Guide*.
- To control notifications from this device:
 - Click the check box next to the host name.
 - Click **Enable** or **Disable** to control whether notifications from this device are sent to the selected host.

System Notification Settings

To access the Notifications page that spans all nodes, click **Administration** on the top navigation bar. On the left navigation pane, select **System > Notifications**.

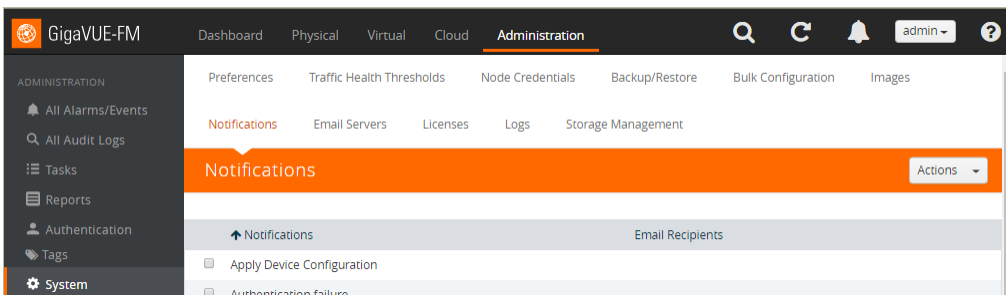


Figure 190: System Event Notification Settings

Refer to the “Notifications” section and “Configure Email Notifications” section in the *GigaVUE-OS and GigaVUE-FM Administration Guide*.

REST API

NOTE: Events and logs go into a database on GigaVUE-FM called Elastic Search. You can use the REST API to access the database and become a client for logs or events.

Traffic Filtering

This section describes the core intelligence provided by GigaVUE-OS and managed through GigaVUE-FM that can be used to optimize your network traffic flow.

Core intelligence is...

- Flow Mapping® that defines policies to extract flows of interest
- GigaStream load balancing that distributes flows across tools
- Terabit-scale configurations with Clustering and Fabric Maps
- Inline Bypass configurations that optimize threat prevention tools, enforcement point
- Visibility across physical, virtual and cloud infrastructure

You can use the GigaVUE-OS traffic management capabilities within GigaVUE-FM by accessing the device that has been added to the fabric manager from the GigaVUE-FM interface. The Traffic option appears in the navigation pane of the device view on supported devices.

To access traffic operations from the GigaVUE-FM interface:

1. Select **Physical** from the top navigation menu.
This displays the list of Devices/Cluster Nodes managed by this instance of FM.
2. Click the Cluster ID of any node to open the node.
The Traffic option is displayed on left navigation pane.

Traffic management topics:

See also:

- [GigaSMART® Operations](#)
- [About Cluster](#)

Ports and GigaStreams

This chapter provides the following information:

- [About Ports](#)
- [Managing Ports](#)
- [Port Discovery](#)
- [Ingress and Egress VLAN](#)
- [How to Use GigaStream](#)

- [Port Statistics and Counters](#)
- [Monitor Port Utilization](#)

About Ports

This section provides an overview of the various port types, describes the steps involved in configuring ports, and provides details about port filters and port status. This section includes the following major topics:

- [About Network and Tool Ports](#)
- [Port Aliases](#)
- [Work with Hybrid Ports](#)
- [Port Filters](#)
- [Status of Line Cards/Nodes and Ports](#)

About Network and Tool Ports

Packets arrive at the Gigamon Visibility Platform at **network ports** and are directed to monitoring and analysis tools connected to **tool ports** by flow maps. [Figure 191: GigaVUE-OS Packet Distribution](#) illustrates the concept of data flows between network and tool ports. Data arrives from different sources at the network ports on the left and is forwarded to different tools connected to the tool ports on the right.

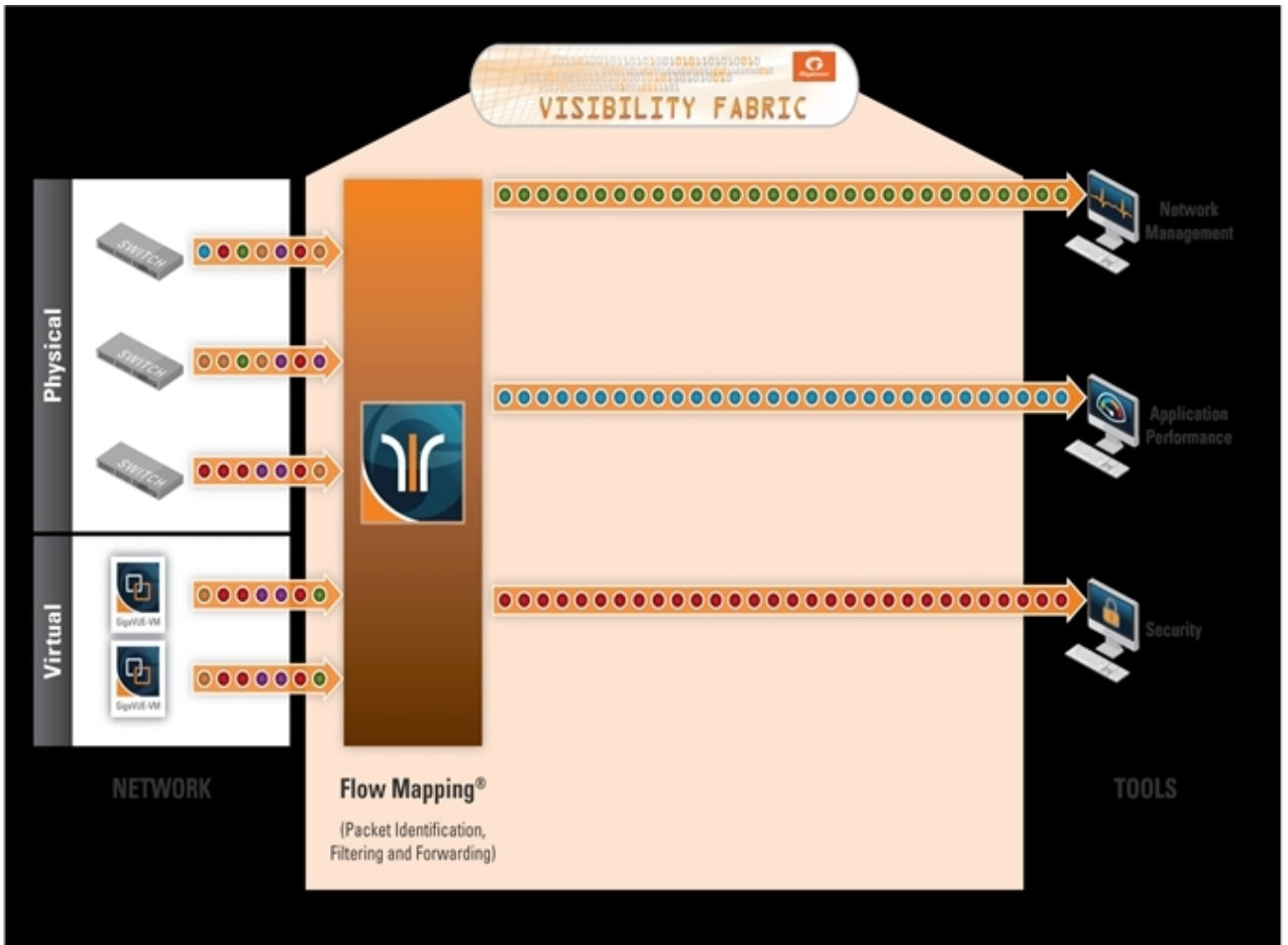


Figure 191: GigaVUE-OS Packet Distribution

Network (Ingress) Ports Defined

Network ports are where you connect data sources to GigaVUE nodes. For example, you could connect a switch’s SPAN port, connect an external TAP, or simply connect an open port on a hub to an open port on a line card. Regardless, the idea is the same – network ports are where data arrives at the GigaVUE node.

NOTE: In their standard configuration, network ports only accept data input – no data output is allowed.

Tool (Egress) Ports Defined

Tool ports are where you connect destinations for the data arriving on network ports on GigaVUE nodes. For example, an IT organization could assign one set of tool ports to its Security Team for an intrusion detection system, a forensic data recorder, and a traditional protocol analyzer while a separate set of tool ports assigned to the Application Performance Management team is used for a

flow recorder and a long-term packet capture device. Regardless of the specific tool connected, the idea is the same – tool ports are where users select different portions of the data arriving on network ports.

NOTE: Tool ports only allow data output to a connected tool. Any data arriving at the tool port from an external source will be discarded. In addition, a tool port's **Link Status** must be **up** for packets to be sent out of the port. You can check a port's link status on the Ports page by selecting **Ports > Ports > All Ports** and looking at the Link Status field. [Figure 192: Port Link Status](#) shows an example where the link status is up for ports 1/1/x1, 1/1/x2, and 1/1/x3 but down for port 1/1/x4.

Filtered By: None										
<input type="checkbox"/>	Port Id	Alias	Type	Speed	Admin Enabled	Link Status	Transceiver Type	Utilization (Tx/Rx)	Port Filter	Discovery Protocol
<input type="checkbox"/>	1/1/x1	ColaSoft_Dedicated_Link_ESX12	IT	1G	✓	up	sfp cu	0 / 0	—	Off
<input type="checkbox"/>	1/1/x2	WireShark_Dedicated_Link_ESX12	IT	1G	✓	up	sfp cu	0 / 0	—	Off
<input type="checkbox"/>	1/1/x3	TunnelPort_From_ESX12	N	1G	✓	up	sfp cu	0 / 0	—	Off
<input type="checkbox"/>	1/1/x4		T		—	down		0 / 0	—	Off

Figure 192: Port Link Status

Ports on GigaVUE TA Series Traffic Aggregator Nodes

Prior to software version 4.7, GigaVUE TA Series Traffic Aggregator nodes did not support tool ports. Instead, they supported gateway ports as displayed in [Figure 193: GigaVUE-TA1 Packet Distribution](#) and described in [Concepts Illustrated in Figure 193: GigaVUE-TA1 Packet Distribution](#).

Starting in software version 4.7, all gateway ports on GigaVUE TA Series nodes are tool ports. For details, refer to [Tool Ports on GigaVUE TA Series Nodes](#).

Figure 193: GigaVUE-TA1 Packet Distribution

Concepts Illustrated in Figure 193: GigaVUE-TA1 Packet Distribution

[Figure 193: GigaVUE-TA1 Packet Distribution](#) illustrates the concept of data flows. Data arrives from different sources at the network ports on the left and is forwarded to different Gigamon nodes connected to the tool ports (formerly gateway ports) on the right.

The following are important points about setting up packet distribution on GigaVUE TA Series nodes:

- Traffic from multiple ingress ports can be sent to the same tool port for aggregated uplink to the Gigamon Platform fabric.

In this example, the traffic from Inputs A, B, and C is all sent to the same tool port. In turn, this tool port is connected to a GigaVUE H Series node so that the combined traffic from these inputs is available to the full suite of Flow Mapping® tools provided by the Gigamon Visibility Platform.

- Traffic arriving at a single network port can be sent to multiple destination tool ports.

Note that in [Figure 193: GigaVUE-TA1 Packet Distribution](#), the traffic arriving on **Input D** is sent to two different tool ports.

- Filters can be applied to tool ports:

Filters applied to tool ports are called **egress-filters**. Egress-filters are useful if you want to send the same traffic to multiple tool ports and have each one allow or deny different packets based on specified criteria. You can use up to **20 egress-filters** at a time on GigaVUE TA Series nodes.

NOTE: In [Figure 193: GigaVUE-TA1 Packet Distribution](#), egress-filters are set to focus on different parts of the data stream arriving at **Input D** – traffic on a VLAN range, a subnet range, and so on.

Tool Ports on GigaVUE TA Series Nodes

Refer to the following notes and considerations for GigaVUE TA Series nodes starting in software version 4.7 (including GigaVUE-TA1, GigaVUE-TA10, GigaVUE-TA40, GigaVUE-TA100, and Certified Traffic Aggregation White Box):

- Gateway ports on GigaVUE TA Series nodes are removed and converted to tool ports. In addition, gateway mirrors are removed and converted to tool mirrors.
- During an upgrade to 4.7 (from a prior software version), gateway ports and gateway mirrors are automatically converted to tool ports and tool mirrors.
- Tool ports on GigaVUE TA Series nodes can continue to be used to aggregate traffic (as displayed in [Figure 193: GigaVUE-TA1 Packet Distribution](#) and described in [Concepts Illustrated in Figure 193: GigaVUE-TA1 Packet Distribution](#)).
- Tool ports on GigaVUE TA Series nodes can also be used to directly connect to tools, such as firewalls, Intrusion Prevention Systems, or Application Performance Monitors.
- GigaVUE TA Series nodes support network, tool, stack, and hybrid port types.
- Hybrid ports are fully supported in both standalone and cluster mode on GigaVUE TA Series nodes. When a GigaVUE TA Series node is in a cluster, hybrid ports can be configured.
- GigaVUE TA Series nodes can continue to be clustered with GigaVUE H Series nodes. Tool ports are supported on GigaVUE TA Series nodes in a cluster.

- When GigaVUE TA Series nodes are in a cluster, bidirectional traffic flow is enabled on the stack links of GigaVUE TA Series nodes.
- Map rules using GigaVUE TA Series tool ports in the egress direction are supported.

Hybrid Ports

Hybrid ports are created by creating a dual function tool port. A physical tool port is set as a virtual network port which can then send traffic to other tool ports using secondary maps. A hybrid port is operated in loopback mode. This is only available if the H node is upgraded to minimum of 4.2 release. For more details on how to setup hybrid ports and the caveats, refer to the *GigaVUE-OS-CLI Reference Guide*.

Stack Ports

Stack ports are used to carry traffic arriving at a network port on one GigaVUE to a tool port on another node in a cluster of GigaVUE H Series nodes.

Inline Network Ports

Inline networks, inline tools, and inline maps work together to form an inline bypass solution. The inline bypass solution has an overall state, which can change in response to hardware conditions and user configuration. Inline network ports are ports to which end-point devices are attached in an inline bypass solution.

NOTE: Inline network ports are supported only on GigaVUE-HC1, GigaVUE-HC2 and GigaVUE-HC3.

Inline Tool Ports

Inline tool ports are ports to which inline tools are attached in an inline bypass solution.

NOTE: Inline tool ports are only supported on GigaVUE-HC2 and GigaVUE-HC1.

Circuit Ports

Required License: Advanced Feature License for GigaVUE-TA Series Nodes

Circuit ports are used to send or receive traffic between two clusters. The circuit ports are configured at the sending and receiving ends of two clusters and the clusters are connected through a circuit tunnel. Circuit ports send or receive only the traffic that is tagged with a circuit-ID. In a map, if a circuit port is used as a source port, it acts as a network port, and decapsulates the traffic that contains a circuit-ID. If a circuit port is used as a destination port, it acts as a tool port, encapsulates the traffic, and strips the circuit-ID.

Circuit ports are supported on the following:

- All GigaVUE H Series and TA Series nodes.
- As a source port in a regular map and as a destination port in a regular collector map.
- GigaStreams, port filter, and port groups.

GigaSMART Engine Ports

GigaSMART Engine ports are used when configuring GigaSMART groups. These ports cannot be edited. On the Ports page, the GigaSMART engine ports populates only the Port ID, Type, and Link Status fields.

Port Lists

Many map commands require a port-list (for example, rule and shared-collector arguments all require them). You can define the port lists using any combination of port IDs and port aliases. In GigaVUE-FM, port lists are created in the **Source** and **Destination** fields when editing or creating a new map. The following are considerations when creating a port list:

- When creating a **Pass All** map, you can specify a network port list or an inline network alias in the **Source** field. In the **Destination** field for a **Pass All** map, you can specify a tool port list, an inline tool alias, an inline tool group alias, or an inline bypass.
- Circuit ports are supported as source ports on Regular maps and as destination ports on Regular Collector maps.
- The **Source** and **Destination** fields lets you select multiple non-contiguous ports. To enter port IDs in a list, simply select the port from the drop-down list after clicking in the field. If the port has an alias, it is shown in the list along with the ID.
- GigaSMART load balancing port groups can have ports with different rates.

Port Aliases

GigaVUE-OS lets you configure textual aliases for network and tool ports. Aliases can be used in place of the numerical **bid/sid/pid** identifier required in many packet distribution.

To set up Port Aliases in H-VUE:

1. Select **Ports > Ports > All Ports**
2. Select the **Port ID** that needs an alias
3. Select **Edit**.
4. In the **Alias** field, enter an alias for the port, and then click **Save**.

Work with Hybrid Ports

A hybrid port is a physical port that has a dual function as an indirect traffic source port and a tool port. Hybrid means that a network port (ingress) can become a tool port (egress) to which map rules can be applied. Hybrid ports are introduced in software version 4.2.

A hybrid port is operated in loopback mode. The network data coming from the internal loopback is available to be used in maps.

Hybrid ports help alleviate the number of ports needed. For example, without hybrid ports, if you had traffic coming in with an MPLS header, but wanted to filter on a particular subnet, you would create a map to remove the MPLS header, physically loop the traffic back from the tool port to a new network port, and create another map to filter on the subnet. This same functionality can now be accomplished with hybrid ports.

If you have been using IP/UDP tunneling to encapsulate whole Ethernet frames and want to filter packets to destination tool ports after being decapsulated by GigaSMART, you can now use hybrid ports.

Hybrid ports can also be used to duplicate traffic from a network source. Using hybrid ports, you can create maps in parallel. For example, all HTTP traffic can be sent to one tool port unmodified and the same HTTP traffic can be sent to another tool port sliced at 100 bytes.

Using hybrid ports, you can create maps in a daisy chain.

As soon as a hybrid port is configured, it is internally changed to loopback mode. This means that the link is *Up* with or without SFPs inserted. (If SFPs are not inserted, the traffic runs at the maximum speed supported.) Traffic flows out of a hybrid port (Tx direction) and the duplicated flow loops back to it (Rx direction). This is similar to tool mirrors.

WARNING: Do not connect cables to hybrid ports coming from network ports. All cabling attached to hybrid ports must be attached to tools.

When a port is configured as a hybrid port type, it can be used as follows:

- as a map source and destination (for regular maps, as well as map-passall, and map-scollector)
- in a GigaStream
- in a port group
- with an egress port filter. The hybrid port has the same limitation as a tool port (100 filters per line card or module). In the GigaVUE-HC2 equipped with Control Card Version 2 (HC2 CCv2) or

the GigaVUE-HC3 node, the limit is 400 filters. The GigaVUE TA Series can only support 20 tool port-filters. When the GigaVUE-TA100 or GigaVUE-TA200 are in a cluster, they can support 400 filters.

Maps using hybrid ports, regardless of source or destination, can be applied to a GigaSMART operation.

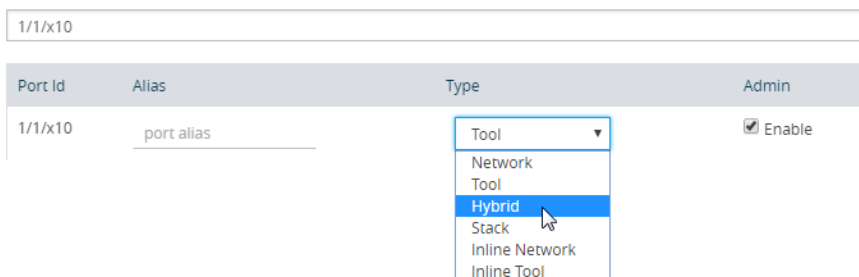
When using hybrid ports, consider the following:

- Be aware not to configure traffic loops, such as such as H1 → H2, H2 → H3, H3 → H1. Do not use the same hybrid port as ingress as well as egress on all maps, such as such as H1 → H1.
- Once a hybrid port is used in a map or other traffic object, the port type cannot be changed.
- Hybrid ports cannot be used in any inline objects, such as inline-network or inline-tool.
- Hybrid ports do not support ingress port VLAN tagging.
- Hybrid ports cannot be used in a tool mirror because that is for tool ports only.
- Hybrid ports cannot be used in a port pair because that is for network ports only.
- Hybrid ports are not supported on 100Gb ports with CFP2 transceivers.

Hybrid ports are supported on GigaVUE H Series nodes. In a cluster environment, hybrid ports can be configured across nodes.

To configure a hybrid port, do the following

1. Select **Ports > Ports > All Ports**.
2. Click **Quick Port Editor**.
3. Enter the port ID, the Quick Search field. For example, 1/1/x10.
 - Click in the **Type** field and select **Hybrid** as shown in the following figure.



4. Click **Save**.

Hybrid ports can be used in the following:

- Regular map
- Regular map with GigaSMART operation
- First level and second level maps with vports

When configuring a map, use a hybrid port as follows:

- In the **Source** field when it is used as an indirect traffic source port
- In the **Destination** argument when it is used as a tool port

NOTE: You cannot use the same hybrid port in one map as both **Source** and **Destination**, or create a loop from multiple maps.

There is no limitation to the number of maps that can be used as second level maps to which packets can be forwarded.

Port Filters

Flow Mapping® provides the ability to apply filters to egress ports, passing or dropping traffic after it has been forwarded from a network port.

Port-filters provide a convenient way to narrow down the traffic seen by egress ports without having to change an entire map. However, they are less efficient and scalable than flow maps – focus on using flow maps as your first packet distribution technique.

How to Apply Port Filters

To apply a port filter, do the following:

1. From the device view, go to **Ports > Ports > All Ports**.
2. Select the egress port to which you want to apply a filter, and then click **Edit**.
3. Under the Filters section on the Ports page, click **Add Rule**.
4. Select and configure the required rule. Add a new port-filter using the specified criteria as follows:
 - Use a **drop** rule to deny packets matching the specified criteria.
 - Use a **pass** rule to allow packets matching the specified criteria. All other packets are denied.
5. Click **Save**.

Port Filter Notes

Keep in mind the following notes when managing port-filters:

- The **filter** is only supported for egress ports – network ports use maps to direct traffic.
- You can only configure egress port filters on a single port at a time. The **filter** argument is blocked when used with multiple tool ports or port groups.

Port-Filter Maximums

Table 29: Port-Filter Maximums per GigaVUE Node provides the maximum port-filters for the different GigaVUE nodes:

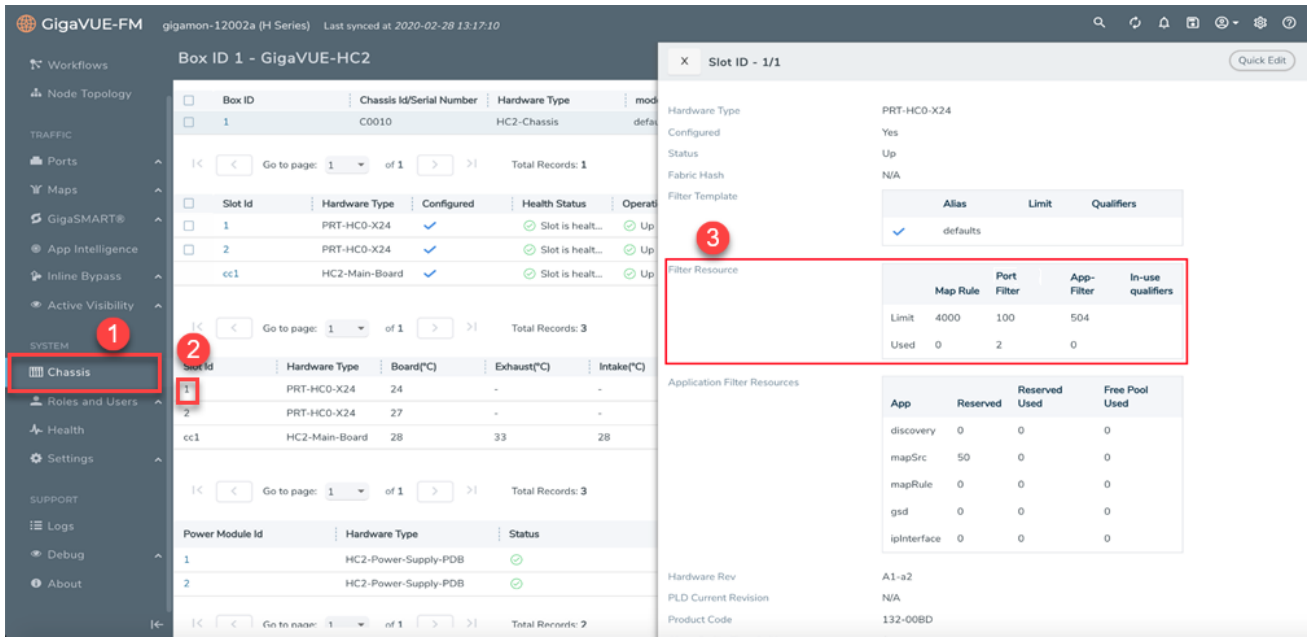
Table 29: Port-Filter Maximums per GigaVUE Node

GigaVUE Node	Maximum Number of Port-Filters
GigaVUE-HC1	100 per module
GigaVUE-HC2 (CCv1 and CCv2)	100 per module
GigaVUE-HC3 (CCv1 and CCv2)	100 per module
GigaVUE-TA10	<ul style="list-style-type: none"> • 20 per chassis • 100 with Advanced Features License
GigaVUE-TA40	<ul style="list-style-type: none"> • 20 per chassis • 100 with Advanced Features License
GigaVUE-TA100	<ul style="list-style-type: none"> • 20 per pseudo-slot • 100 per pseudo-slot with Advanced Features License
GigaVUE-TA100-CXP	<ul style="list-style-type: none"> • 20 per chassis • 100 with Advanced Features License
GigaVUE-TA200	<ul style="list-style-type: none"> • 20 per pseudo-slot • 100 per pseudo-slot with Advanced Features License

NOTE: A single filter applied to multiple tool ports counts multiple times against the 100-filter limit.

You can view the maximum filter resources available and the filter resources used for a slot in the Slot ID quick view. To access the Slot ID quick view:

1. From the device view, go to **Chassis**. The Box ID page appears.
2. Click the required slot ID. The Slot ID quick view appears.
3. Go to the Filter Resource section to view the filter resources limit and the filter resources used. Refer to the following figure:



Status of Line Cards/Nodes and Ports

You can review the current status of the node, line cards, modules, and ports through either the CLI or the H-VUE. This will ensure that all units have been properly configured and that the node is ready for further configuration.

To check the line cards/modules and ports with H-VUE, using the Ports page or the Chassis page (select **Chassis** in the navigation pane).

How to Check Port Status with Ports Page

To check the port status with the Ports page, do the following:

1. Select **Ports > Ports > All Ports** to open the Ports page.
2. Locate the port to check by entering the port ID or port alias in the search field.
3. If you need to change the port type or enable the port:
 - a. Click **Quick Port Editor**.
 - b. In the Quick Port Editor, enter the port ID or port alias in the Quick search field to find the port.
 - c. Set the port type by selecting type from the drop-down list in the **Type** field. enable the by selecting **Enable** as needed.

How to Check Port Status with Chassis Page

To check the status of the ports and cards with the Chassis page, do the following:

1. Select **Chassis** from the Navigation pane to open the Chassis view shown in [Figure 194: Chassis Page](#).
2. Use the view buttons on the Chassis page to check the status of the cards as well as the ports. When viewing a node in cluster, there is a drop down option to select a specific node in a cluster configuration.

For details about the Chassis page, refer to the “Chassis” section in the *GigaVUE-OS and GigaVUE-FM Administration Guide*.

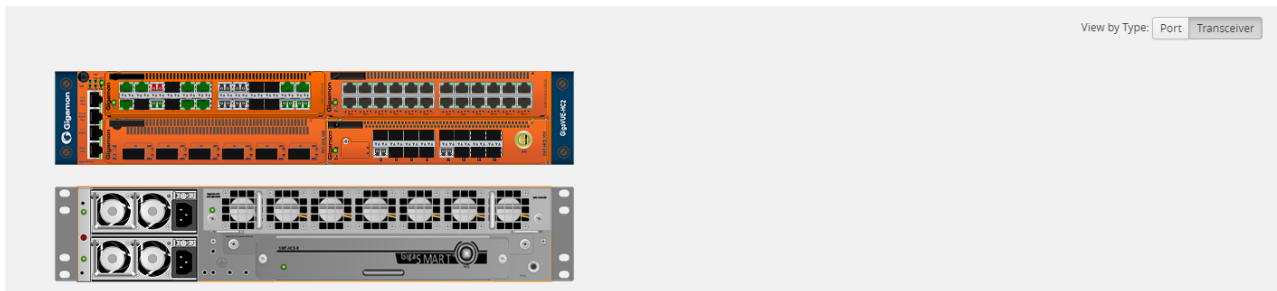


Figure 194: Chassis Page

Managing Ports

The Ports pages allows you to manage and configure ports for various functions. In case of an GigaVUE-HC2, the pages for managing inline bypass ports are available by selecting Inline Bypass from the main navigation pane.

Before beginning with managing and configuring ports, make sure that the user role, which is assigned to a User Group, has the permission for the specific ports on the system. For details on the port-based access levels, refer to the *GigaVUE-OS-CLI Reference Guide* and “Managing Roles and Users” in the *GigaVUE-OS and GigaVUE-FM Administration Guide*.

This section provides a description of the Ports pages in the H-VUE UI. It covers the following topics:

- [Ports](#)
- [Port Groups](#)
- [Port Pairs](#)
- [Tool Mirrors](#)
- [Stack Links](#)
- [IP Interfaces](#)
- [Circuit Tunnels](#)

NOTE: Starting in software version 5.5.01, any change in the port health status is indicated immediately in the following port pages:

- Ports > All Ports
- Port Groups > All Port Groups
- Port Groups > GigaStream
- Port Pairs
- Tool Mirrors
- Stack Links
- IP Interfaces

The link in the notification opens the port quick view.

Ports

The Ports tab lets you select the All Ports and Ports Discovery pages. You can also control which ports display.

All Ports

The All Ports page displays when you select All Ports. The Ports page shows a table with detailed information about each port ID on a specific device. Only the GigaVUE H Series and GigaVUE TA Series devices are presented in the Port Page view as shown in [Table 30: Descriptions of Ports Page Columns](#). You can control which ports display on the page by selecting a set of filters or configure the ports through the Quick Port Editor or selecting Edit for a selected port. For details about filtering ports, refer to [Port List Filter](#). For details about the Quick Port Editor, refer to [Quick Port Editor](#).

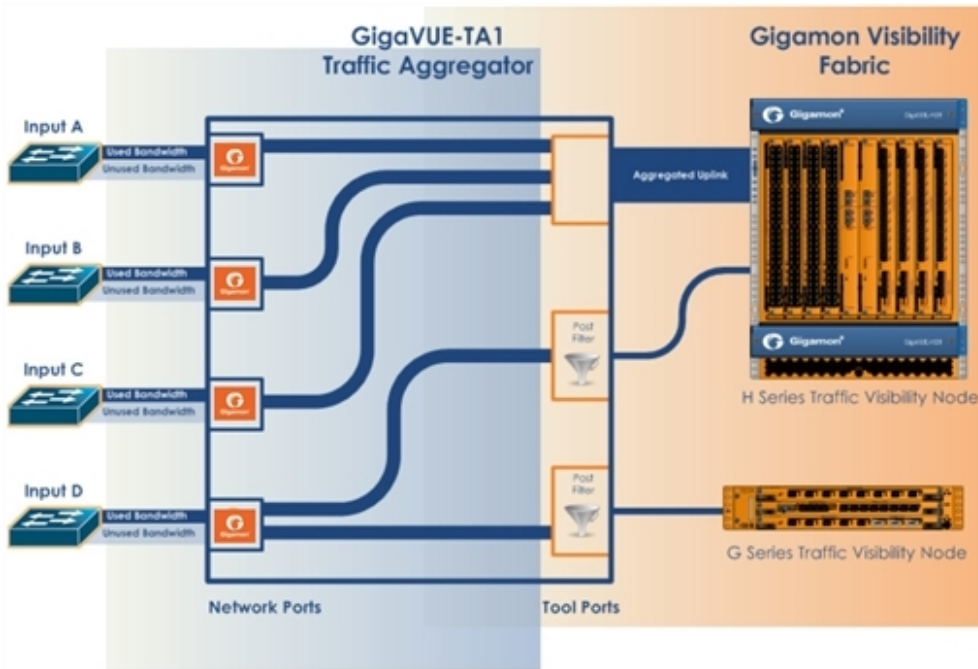


Figure 195: Ports Page

The port type determines which columns are populated with data in the table. The columns are populated as follows:

- **Engine** ports populate the Port ID, Type, and Link columns.
- **Network** ports populate the Port ID, Alias, Type, Speed, Admin Enabled, Link Status, Transceiver Type, Utilization, Port Filter, and Discovery Protocol.
- **Tool** port populate the Port ID, Alias, Type, Speed, Admin Enabled, Link Status, Transceiver Type, Utilization, Port Filter, and Discovery Protocol.
- **Stack** port populates Port ID, Alias, Type, Admin Enable, Link Status, Utilization, Port Filter, and Discovery Protocol.
- **Hybrid** port populates Port ID, Alias, Type, Admin Enable, Link Status, Utilization, Port Filter, and Discovery Protocol.
- **Circuit** port populates Port ID, Alias, Type, Admin Enable, Link Status, Utilization, Port Filter, and Discovery Protocol.
- **Inline Network** port Port ID, Alias, Type, Admin Enable, Link Status, Utilization, Port Filter, and Discovery Protocol.
- **Inline Tool** port Port ID, Alias, Type, Admin Enable, Link Status, Utilization, Port Filter, and Discovery Protocol.

NOTE: Not all port types are supported on all platforms. Inline network and inline tool ports are only supported on GigaVUE HC Series nodes.

Table 30: Descriptions of Ports Page Columns provides descriptions of the columns on the ports page.

Table 30: Descriptions of Ports Page Columns

Column	Description
Port ID	<p>The port number is in <box ID>/<slot ID>/<port_ D> format in the CLI and H-VUE. For the GigaVUE TA Series and the GigaVUE-HB1 slot ID is always 1 as they are not modular. For the GigaVUE-HC1, GigaVUE-HC2, and GigaVUE-HC3, the line cards or modules are identified by the slot number.</p> <p>In a standalone (default) configuration, box ID is always designated as 1 but can be changed through the CLI (it cannot be changed through H-VUE). In a cluster configuration, the box ID can vary.</p>
Alias	Alias name of the port, if any.
Status	<p>Health status of the port.</p> <p>NOTE: When a ports administrative status changes from 'enabled' to 'disabled', the health status of the administratively disabled ports remains in Green. However, the health status of administratively disabled port is indicated as NA if Exclusion Rules are enabled for the ports that are admin disabled in the Alarms Page. Refer to the 'Manage Alarms' section in the GigaVUE Administration Guide for more details.</p>
Type	<p>List the type of port such as network, tool, stack, inline network, inline tool, circuit, or hybrid. You can set the port type through the Quick Port Editor or selecting the port on the Port page and clicking Edit. The port type is set by selecting the type in the Type field.</p>
Speed	Current setting for the port's speed.
Admin	Indicates whether the port is administratively enabled or disabled.
Force Link Up	Indicates the 'force link up' setting for the port. When enabled, this option forces connection on the optical port.
Ude	Indicates whether the port is enabled for unidirectional (Ude) or bidirectional traffic. Enabled means Ude; Disabled means bidirectional.
FEC	Configures forward error correction (FEC) on the port to ensure error-free traffic over long distance. The values are:

Column	Description
	<ul style="list-style-type: none"> • CL91—Enables FEC on the port. • OFF—Disables FEC on the port. This option is available only on 25Gb and 100Gb transceivers.
Link Status	The current status of the link connected to the port, either port link up or port link down.
Transceiver Type	The type of transceiver installed in this port.
SFP Power	SFP power for copper transceivers
Port Filter	Indicates if the egress port filter , is associated with this port.
Discovery Protocol	Protocol used to discover neighboring nodes using CDP or LLDP. This feature is available for network, tool and circuit ports.
Box Hostname	Host name of the device
Gigamon Discovery	Indicates if Gigamon Discovery protocol is enabled

Port Quick View

The Quick View for ports displays when you click on a row in the Ports page to quickly get more information about a specific port. The quick view shows the port properties, statistics information on receiving (Rx) and/or Transmitting (Tx) ports and alarms information. The quick view also shows a graphical representation of port statistics. Refer to [Figure 196: Ports Quick View](#) for an example.

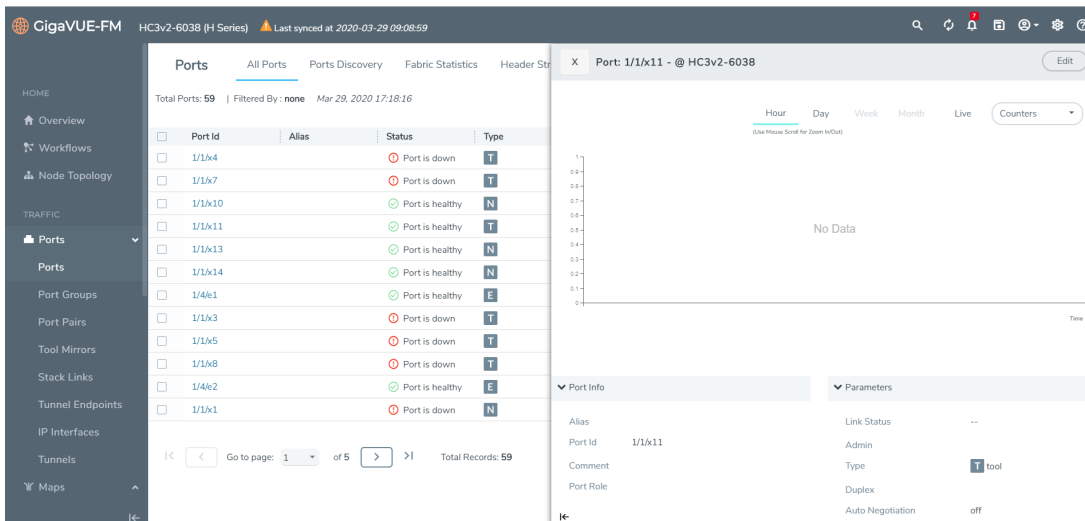


Figure 196: Ports Quick View

Port List Filter

The ports that display on the Ports page can be filtered so that only ports that meet certain criteria display on the page, such as port type and admin status. To filter the ports, select **Filter**. This opens the Filter view shown in [Figure 197: Port List Filter](#) where you can specify how to filter ports displayed on the Ports page.

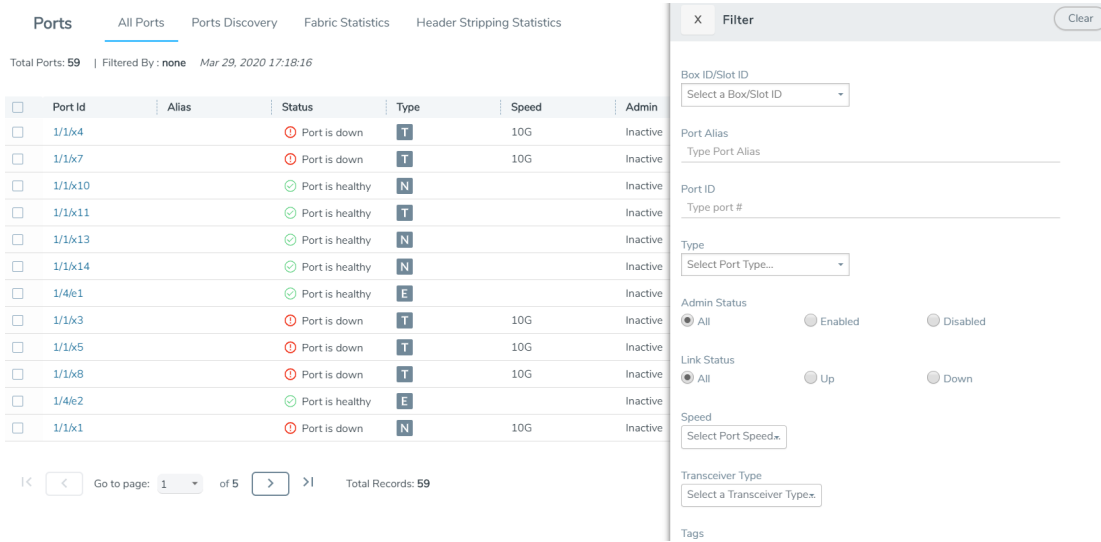


Figure 197: Port List Filter

The criteria that you can use to filter the port list is as follows:

Criteria	Description
Box/Slot ID	Display only those ports that match the specified box and slot IDs.
Port Alias	Display port with the specified alias.
Port ID	Display ports with specified number in the port ID. For example, if you specify 3 the result will also display ports that include the number 3, 13, 23, 30, and so on.
Type	Display ports with the specified port type. Select one of the following: Network Tool Inline Network Inline Tool GigaSMART Hybrid Circuit

Criteria	Description
	Stack
Admin Status	<p>Display ports based on their current admin status. The possible selections are:</p> <p>All — display ports with a status of Enabled or Disabled. This is the default.</p> <p>Enabled — display ports with admin enabled</p> <p>Disabled — display ports with admin disabled</p>
Link Status	<p>Display ports based on their current link status: The possible selections are:</p> <p>All — display ports with a status of Up or Down. This is the default.</p> <p>Enabled — display ports with a link status of up.</p> <p>Disabled — display ports with a link status of down.</p>
Speed	<p>Display ports with the selected port speed. The port speeds available depend on the node.</p>
Transceiver Type	<p>Display ports with the selected transceiver type. The transceivers available selection depend on the type of transceivers connected to the ports.</p>

To filter the ports, enter the information to use for filtering the ports and select the radio buttons. For example, in [Figure 198: Filtering by Network Port Type and Admin Status Enabled](#), the filters selected are Network Type and Admin Status Enabled. Click the **Clear** button to remove the filter selections.

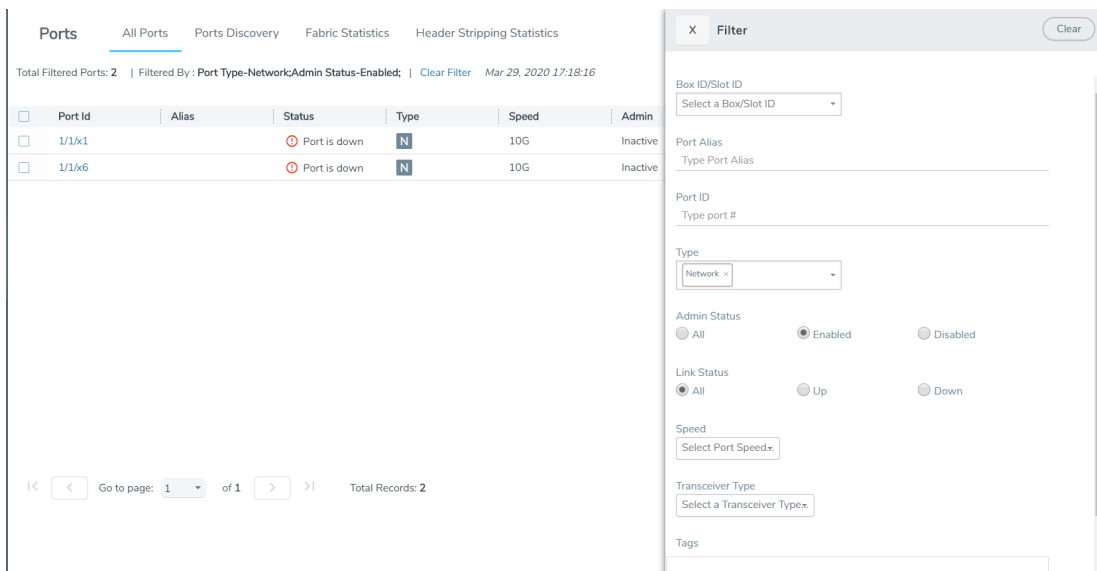
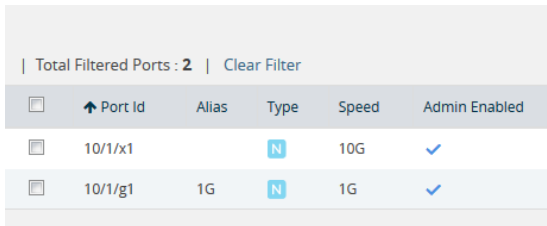


Figure 198: Filtering by Network Port Type and Admin Status Enabled

After the filter is applied, the Ports page displays only the ports that correspond to the selected filters and shows the total number of ports that meet the criteria. To clear the filters, select **Clear Filter**. [Figure 199: Filtered Ports List](#) shows the Port pages with two ports that correspond to the current filters: Network Type and Admin Status Enabled.



Total Filtered Ports : 2 Clear Filter					
<input type="checkbox"/>	↑ Port Id	Alias	Type	Speed	Admin Enabled
<input type="checkbox"/>	10/1/x1		N	10G	✓
<input type="checkbox"/>	10/1/g1	1G	N	1G	✓

Figure 199: Filtered Ports List

Quick Port Editor

From the Ports page, you can open the Port Type Editor to quickly change the port types in a chassis. To set the port type for ports in a chassis, do the following:

1. Click **Quick Port Editor**.
2. For each port on which you want to set the port type, select the type from the drop-down list. In [Figure 200: Port Type Selection](#), port 1/1/x9 is being changed from a network port to at tool port.

To find a specific port, you can use the Quick Search to find a specific port by entering the port ID or alias in the Quick search field.

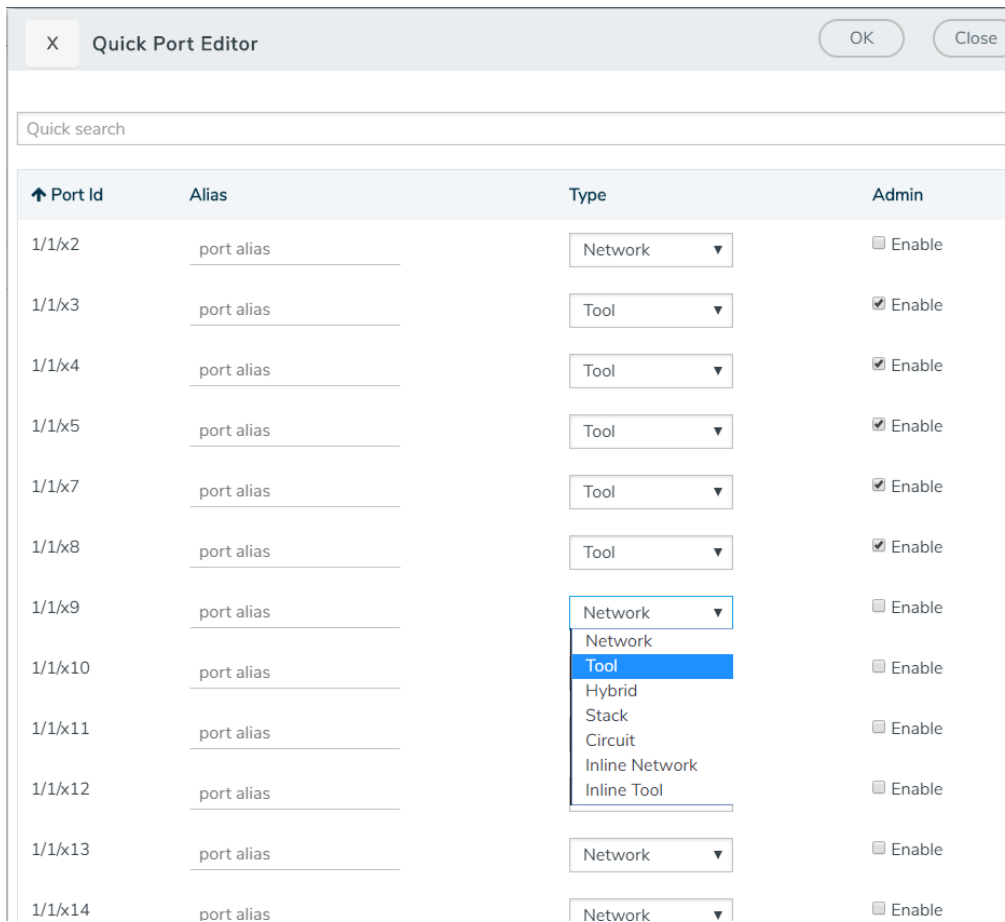


Figure 200: Port Type Selection

- To enable the port, select **Enable**.
- Click **OK**.

Each port can also be assigned an alias. Any port types set in the CLI or through the GigaVUE-FM APIs are reflected on this page. Any changes made in H-VUE are reflected in the CLI and responses to an API. For more information, refer to [Port Aliases](#) for port aliases and to the *GigaVUE-FM REST API Reference* in *GigaVUE-FM User's Guide* and the *GigaVUE-FM Reference* for APIs.

Configure Ports

From the Ports page, you can either configure or edit a specific port by selecting a port and clicking the **Edit** button on the Ports page or on the Quick Port Editor. [Table 31: Port Configuration Options](#) describes the options on the configuration page.

Table 31: Port Configuration Options

Field	Description
Alias	<p>The alias configured for this port, if any. Aliases can be used in place of the numerical bid/sid/pid identifier required in many packet distribution commands in the CLI.</p> <p>For example, instead of configuring a connection between, say, 1/1/x1 and 1/2/x4, you could connect Gb_In to Stream-to-Disk. Note that aliases can only be applied to single ports. They cannot be applied to groups of ports. Port alias can be up to 128 characters long including special characters. Aliases are case sensitive.</p>
Admin	Check to enable the port.
Type	Specifies whether the port is configured as an Inline Network port, Inline Tool port, Network port, Tool port, Stack port, Circuit port, or Hybrid port.
Speed	Specifies the speed for the selected port. For copper ports, you can click to change the speed as long as Auto Negotiation is disabled.
Duplex	Specifies the port's duplex configuration. Only full duplex is supported. Starting in software version 5.2, half duplex support is removed from all GigaVUE nodes. If half duplex was configured in a previous software version, it will remain intact following the upgrade to 5.2 or higher release. Update to full duplex, if required.
Auto Negotiation	Select to enable autonegotiation for the selected port. When autonegotiation is enabled, duplex and speed settings are ignored. They are set through autonegotiation.
Force Link Up	When enabled, this option forces connection on an optical port. Use this option when an optical GigaPORT tool port is connected to a legacy optical tool that does not transmit light. This option is not available for 10Gb capable ports with a 1Gb SFP installed.
Ude	When selected, this option indicates the port is unidirectional (UDE). When deselected (disabled), the port is bidirectional. UDE is enabled by default.
FEC	Configures forward error correction (FEC) on the port to ensure error-free frame over long distance. The values are: <ul style="list-style-type: none"> CSF1 - Enables FEC on the port. OFF - Disables FEC on the port. <p>Important: If you clear the UDE check box, the laser will start to transmit, which may affect the remote connectivity. This option is available only on 25Gb and 100Gb transceivers.</p>

Field	Description
Timestamp	<p>Use the timestamp options when a GigaPORT-X12-TS line card is installed. For details about the GigaPORT-X12-TS line card, refer to the <i>GigaVUE-OS-CLI Reference Guide</i>. The timestamp options are as following:</p> <p>Append Ingress—Use this option to add a timestamp to ingress packets a GigaPORT-X12-TS ports. This applies to ports x1..x12 when configured as network ports.</p> <p>Strip Egress—Use this option to strip timestamps from egress packets.</p> <p>Source ID Egress—Use this option to specify a custom source ID to be included in the timestamp appended by the GigaPORT-X12-TS. The source ID identifies the ingress port on the GigaVUE H Series node where the timestamped packet arrived.</p> <p>The timestamp always includes a source ID. If you do not specify a custom value, the GigaPORT-X12-TS generates one automatically using the following formula:</p> <p>(Box ID * 2048) + (Slot ID * 256) + Port Number</p> <p>Important: Only apply the Strip Egress option to packets with time stamps appended. The strip egress feature strips the last 14 bytes of each packet regardless of whether a timestamp has been added.</p>
VLAN Tag	<p>Use VLAN tags to identify, differentiate, or track incoming sources of traffic. When the traffic reaches the tools or the maps, you can filter on the VLAN tags for the corresponding ports you want to measure.</p> <p>Ingress port VLAN tagging is supported for IPv4 and IPv6 packet types, including non-tagged packets, tagged packets, and Q-in-Q packets.</p> <p>Ingress port VLAN tagging is not supported on inline network ports, hybrid ports, or on network ports that are connected via port-pairs. The same VLAN tag can be assigned to multiple network ports. However, each port can only have one VLAN tag. VLAN tagging is supported in a cluster.</p> <p>To add, VLAN IDs for a Port, enter the VLAN ID in this field.</p> <p>To modify, update the VLAN ID in this field and Save. It will take effect.</p> <p>To delete, remove any values for the VLAN ID in this field and Save. It will remove the VLAN Tag from this Port.</p> <p>VLAN tags are only available on network ports.</p>
Port Discovery	<p>Select to enable discovery of neighbors associated with the port. Neighbor discovery is only available on network ports</p>
Discovery Protocols	<p>When port discovery is enabled, use the Discovery Protocol options to set up CDP or LLDP or both (All) on the port. The results are shown on the Ports</p>

Field	Description
	Discovery page.
Buffer Threshold	Specifies the alarm buffer threshold on a port. You can specify the alarm buffer threshold in the Rx and Tx directions on network and stack type ports and in the Tx direction on tool type ports. By default, the threshold is set to 0 , which disables the threshold
Utilization Threshold	Sets the utilization percentage for this port at which the GigaVUE H Series node will generate high or low utilization alarms for the port. For more information about port utilization, refer to Monitor Port Utilization . By default, the threshold is set to 0 , which disables the threshold.
Lock Port	Restricts use of the port for only your user account as follows: <ul style="list-style-type: none"> • Users with the admin role can lock any port in the system. Users with the Default/Operator role assigned can only lock ports to which their account has been granted access. • Administrators can lock a port for another user by including the optional user. <p>You can optionally share a locked port by specifying users in the Lock shared with Users field or selecting users to share the lock with through their assigned roles. For more information about who to set lock sharing, refer to Managing Ports.</p>
Tags	

Ports Discovery

The Ports Discovery page displays the port neighbor information for each port that has discovery enabled. For each network port on which discovery is enabled, neighbor information is collected. Information for up to five of the most recent neighbors is retained for each port.

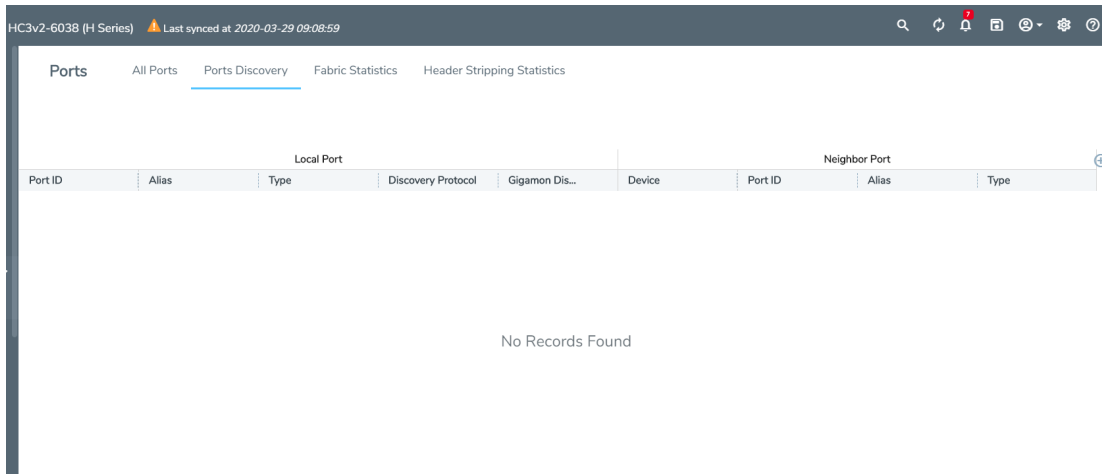


Figure 201: Ports Discovery Page Displaying Neighbors Found Using Discovery

The following are limits on the amount of discovery information that is retained:

- For each port, discovery information for a minimum of two neighbors and a maximum of 20 neighbors is retained.
- For a chassis, discovery information for a maximum of 2K neighbors is retained.

Neighbor information is removed or replaced as follows:

- When the neighbor information expires due to the TTL.
- When the number of neighbors for the chassis reaches the 2K maximum and a new neighbor is discovered. In this case, the following can occur:
 - If there are currently two or more discovered neighbors for a port, the newly discovered neighbor replaces the neighbor information for the least recently updated neighbor.
 - If there are currently less than two discovered neighbors for a port, the newly discovered neighbor is added (actually exceeding the 2K limit to guarantee a minimum of two neighbors per port).

NOTE: Aging (the discovery protocol time-to-live) determines how long neighbor information is valid.

For information about the discovery protocols and enabling port discovery, refer to [Port Discovery](#)

Statistics

The Statistics page displays the statics for all the ports on the node, providing the following information about a packets transmitted or received on a port:

Column	Definition	Notes
Octets (Rx/Tx)	The count of packets/bytes received and transmitted by this port.	Error packets are not transmitted, therefore they are not counted. Excludes undersize frames.
Octets/sec (Rx/Tx)	The count of packets/bytes received and transmitted by this port per sec.	Error packets are not transmitted, therefore they are not counted.
Unicast Packets (Rx,/Tx)	The count of packets/bytes received and transmitted by this port.	Excludes multicast packets, broadcast packets, packets with FCS/CRC errors, MTU exceeded errors, oversize packets, and pause packets.
Non-Unicast Packets (Rx/Tx)	Total Non-unicast packets received or transmitted.	
Packets/sec (Rx/Tx)	The rate which packets are received or transmitted.	
Packet Drops (Rx)	Total Dropped Packets	Packets are dropped when a network port's bandwidth is exceeded due to oversubscription. Packets are dropped when they reach the port but before they are sent out.
Discards (Rx/Tx)	Total received and transmitted packets discarded. This counter increments when a packet is discarded at the tool port due to egress port filter.	Discards are counted in the following cases: Traffic arriving at a network port that is not logically connected using a map or map passall. Map rules applied on a network port. In packets on a tool port. Pause frames.
Errors (RX/TX)	Total Error Packets Received or Transmitted. Error packets include undersize, FCS/CRC, MTU exceeded, fragments, and oversize packets.	Excludes oversize packets without FCS/CRC. Packets larger than the MTU setting arriving on a network port are counted twice in the counter. So 1000 oversize packets would show up as 2000. This double-counting only happens with Oversize error packets.
Utilization (Rx/Tx)	Percentage of port utilization by packets received or transmitted	

Port Groups

The Port Groups selection in the top navigation bar provides access to the All Port Groups and GigaStream pages, for creating port groups and GigaStreams, respectively.

All Ports Groups

Selecting **All Port Groups** under **Port Groups** opens the **Ports Group** page by default. This page is used to create a port group, which can simplify administration of GigaVUE ports. Administrators can create groups of ports that can then be quickly assigned to different user groups. With clustered ports potentially numbering into the hundreds, port groups provide a useful shorthand when assigning multiple ports to different user groups. (To create user groups, select **Roles and User** from the navigation pane, and refer to *Managing Roles and Users* in the *GigaVUE-OS and GigaVUE-FM Administration Guide* for more details.) The following are the different types of port groups:

- Network Port Group—contains only network ports.
- Tool Port Group—contains only tool ports or tool GigaStream, which is a combination of multiple tool ports.
- Hybrid Port Group—contains only hybrid ports or hybrid GigaStream, which is a combination of multiple hybrid ports.
- Circuit Port Group—contains only circuit ports or circuit GigaStream, which is a combination of multiple circuit ports.
- Load Balancing Port Group—contains tool ports for load balancing. The maximum number ports allowed for port balancing is 16.

However, port groups that include GigaStream can only be used with GTP Overlap Flow Sampling maps. For more information about GTP Flow Sampling, GTP Whitelisting and GTP Overlap Flow Sampling maps, refer to [GigaSMART GTP Whitelisting and GTP Flow Sampling](#).

GigaStreams

Selecting **GigaStreams** under **Port Groups**, opens the GigaStreams page. A GigaStream is a bundle of multiple ports on a GigaVUE-OS node used for stacking, tool ports. The following are the types of GigaStream you can create:

- Tool GigaStream—It is a bundle of multiple tool ports used as a single logical group. This type of GigaStream as a single addressable destination, allowing you to overcome tool port oversubscription issues.
- Hybrid GigaStream—It is a bundle of multiple hybrid ports that are combined into a single logical group in all H Series nodes.

- **Stack GigaStream**—It is a bundle of multiple stack ports used as a single logical group. Stack-links can use GigaStream to distribute data between multiple H Series nodes operating in a cluster. With the number of 10Gb/40Gb/100Gb ports possible in a GigaVUE H Series chassis, using only one 10Gb port for a stack-link could cause a serious bottleneck. A GigaStream dramatically increases the bandwidth available for stack-link connections, letting you connect H Series nodes in a cluster and still take advantage of the 10Gb port density.
- **Circuit GigaStream**—It is a bundle of multiple circuit ports that are combined into a single logical group. The circuit ports send or receive traffic that is tagged with the circuit ID.
- **Controlled GigaStream**
Controlled GigaStream provides more control of the traffic stream by specifying the size of a hash table and allowing the assignment of hash IDs to the ports in a GigaStream. This makes it possible to keep the hashing algorithm from reapplying the algorithm to the ports if one of the ports in the GigaStream goes down.

For more detailed information about GigaStreams, refer to [How to Use GigaStream](#)

Port Pairs

A port-pair is a bidirectional connection in which traffic arriving on one port in the pair is transmitted out the other (and vice-versa) as a passthrough TAP. Keep in mind the following rules and notes for port-pairs:

- You can configure whether a port-pair uses link status propagation. Link port propagation does the following:
 - **Enabled**—when one port in the pair goes down, the other port goes down.
 - **Disabled**—when one port in the pair goes down, the other port is unaffected.
- Port-pairs can be established between ports using different speeds. For example, from a 100Mb port to a 1Gb port. However, the system will warn you when creating such port-pairs. Depending on traffic volume, port-pairs between ports using different speeds can cause packet loss when going from a faster port to a slower port. For example, going from 1Gb to 100Mb, from 10Gb to 1Gb, and so on.

To configure a port pair, do the following:

1. Select **Ports > Port Pairs**.
2. Click **New**.
3. On the Port Pair page, do the following:
 - a. (Optional) Type an alias in the **Alias** field to help identify this port pair.
 - b. (Optional) Type a comment in the **Comment** field.

- c. Click in the **First Port** field and select a network port.
- d. Click in the **Second Port** field and select another network port.
- e. (Optional) Enable **Link Failure Propagation**.

Port pairs can operate with or without line failure propagation (LFP) as follows:

- With LFP enabled, link failure on one of the ports in the port pair automatically brings down the opposite side of the port pair.
- With LFP disabled, the opposite port is not brought down automatically.

Note: A port pair created on a copper TAP has LFP enabled by default.

4. Click **Save**.

Tool Mirrors

In addition to maps, the GigaVUE-OS also includes a special Tool Mirror packet distribution feature. A Tool Mirror can be used to send all packets on one tool port to another tool port (or multiple tool ports) or GigaStream on the same box. Tool Mirrors can still be applied to network ports even if they are already in use with an existing connection or map. Use tool-mirror connections between tool ports/GigaStreams on the same node, cross-box tool-mirror connections are not supported.

Tool-mirror can be created from:

- Tool port to tool port or ports on the same node.
- Tool port to GigaStream or GigaStreams on the same node.

The destination for a tool-mirror must always be either a tool port or a GigaStream.

- Tool Mirrors can cross line cards/modules – they can start on one line card and end on another in the same node. However, they cannot cross nodes in a cluster. On GigaVUE-HC2, tool-mirrors can exist between ports on separate modules on the same node.
- Tool Mirrors on GigaVUE-HB1 can be created on tool ports or GigaStream ports.
- Tool Mirrors are not allowed from Tool GigaStream to tool port.
- Tool Mirrors are not supported on tool ports with copper SFPs installed.

Create Tool Mirror

To create a Tool Mirror, do the following:

1. Select **Ports > Tool Mirrors**.

The Tool Mirrors page displays a list of the currently configured Tool Mirrors.

2. Click **New**.

The Tool Mirror configuration page appears.

3. Configure the Tool Mirror:
 - a. Enter an alias in the **Alias** field.
 - b. (Optional) Enter a comment in the **Comment** field.
 - c. Click in the **Source Tool Ports** field and select the source tool ports for this tool mirror.
 - d. Click in the **Mirror Destination Ports** field and select the destination tool ports for this tool mirror.
4. Click **Save**.

Edit Tool Mirror Comments

Comments in a Tool Mirror configuration are optional. However, you can add comments at any time, or edit existing comments. To add or edit comments, do the following:

1. Select **Ports > Tool Mirrors**. The Tool Mirrors page displays a list of the currently configured Tool Mirrors.
2. Select a Tool Mirror in the list of Tool Ports, and then click **New**.
3. Enter or change a comment in the **Comment** field. (You cannot make any other changes to the Tool Mirror.)
4. Click **Save**.

Clone Tool Mirror

In some cases, you may want to create a Tool Mirror that is similar to an existing one. To do this use the Clone feature.

1. Select **Ports > Tool Mirrors**.
2. Select the Tool Mirror that you want to copy, and then click **Clone**.
3. Enter a new alias in the **Alias** field.
4. (Optional) Add or update comments in the **Comments** field.
5. Make change to the **Source Tool Ports** and **Destination Tool Ports** as needed.
6. Click **Save**.

Stack Links

You use stack-links to connect multiple GigaVUE nodes in a unified cluster. The stack-links carry traffic entering one system and bound for another via a map. Stack management traffic uses its own dedicated network connections through the Stacking ports on the Control Cards.

You can construct stack-links either out of single stack ports or a stack GigaStream. However, because of the incredible 10Gb port density offered by the GigaVUE HC Series, using only one 10Gb port for a stack connection could cause a serious bottleneck.

A stack GigaStream dramatically increases the bandwidth available for stack connections, letting you connect GigaVUE nodes in a cluster and still take advantage of the 10Gb port density. Alternatively, nodes with 40Gb or 100Gb ports can take advantage of their high bandwidth for stack-links. (For more details about clustering, refer to the *GigaVUE-OS-CLI Reference Guide*.)

Stack links are supported at speeds of 10Gb, 40Gb, and 100Gb. Refer to the *Hardware Installation Guide* for each GigaVUE node for information on stack link support.

When using stack GigaStream for stack-links, you must create a stack GigaStream on each side of the stack-link and each must consist of the same number of ports running at the same speed.

To create a stack link, do the following:

1. Select **Ports > Stack Links**.
2. Click **New**.
3. Enter an alias for the stack link in the **Alias** field.
4. Select the **Type** for this stack link.
 - **Stack Ports** specifies that the stack link is between two ports.
 - **Stack GigaStream** specifies that the stack link is between GigaStream.
5. In the First Member and Second Member fields, select the ports or GigaStream for the stack link, depending on the type selected in [Step 4](#)
6. Click **Save**.

IP Interfaces

You can configure IP interface in the control card. All the control operations such as the gateway resolution, tunnel health check, and NetFlow exporter SNMP requests are handled in the control card. Similarly, the ARP/NDP timer configuration is also moved to the control card. You can associate an IP interface with multiple GigaSMART groups that are created either in the same node or in another node that resides in the same cluster. Moreover, you can associate multiple GigaSMART engines to a GigaSMART group. You can also associate NetFlow exporters to the IP interface.

About IP Interface Centralization

A tunnel that originates from a node in a cluster can terminate on a remote port in another cluster. Also, a tunnel can have multiple termination points. You can associate the IP interface with multiple GigaSMART groups that are created either in the same node or in another node that resides in the same cluster. Moreover, you can associate multiple GigaSMART engines to a GigaSMART group.

The following figure illustrates the tunnel centralization feature.

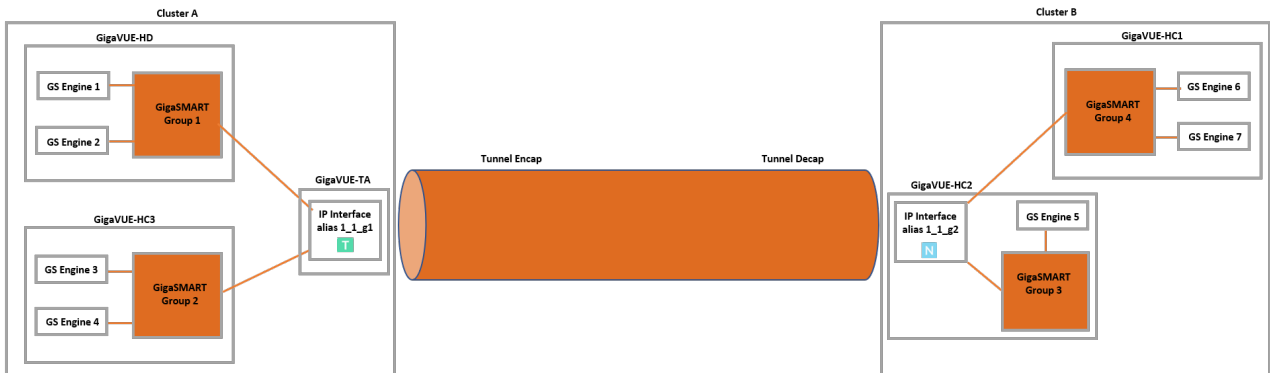


Figure 202: Tunnel Centralization

In this example, the GigaVUE-HD, GigaVUE-HC3, and GigaVUE-TA nodes reside in cluster A. In GigaVUE-HD, GigaSMART engines 1 and 2 are associated with the GigaSMART group 1. Similarly, in GigaVUE-HC3, GigaSMART engines 3 and 4 are associated with GigaSMART group 2. An IP interface with alias 1_1_g1 is configured with a tool port in GigaVUE-TA. Both the GigaSMART groups, 1 and 2 are associated with the IP interface. The IP interface 1_1_g1 is the originating point for the tunnel, where encapsulation happens.

Now, let us look at the termination point of the tunnel. The GigaVUE-HC1 and GigaVUE-HC2 nodes reside in cluster B. In GigaVUE-HC2, the GigaSMART engine 5 is associated with GigaSMART group 3 and in GigaVUE-HC1, the GigaSMART engines 6 and 7 are associated with GigaSMART group 3. An IP interface with alias 1_1_g2 is configured with a network port in GigaVUE-HC2. Both the GigaSMART groups, 3 and 4 are associated with the IP interface. The IP interface 1_1_g2 is the termination point for the tunnel, where decapsulation happens. Thus the tunnel terminates on a remote port in another cluster.

Upgrade from Release 5.4.xx

When you upgrade from release 5.4.xx to either 5.5.xx or 5.6.xx, the tunnel ports that were configured prior to the upgrade will be converted to IP interface. The IP interfaces that are converted during the upgrade will have a standard naming convention, "giga_auto_tunnel_<bid>_<sid>_<pid>", where *bid* is the box ID, *sid* is the slot ID, and *pid* is the port ID.

For example, the tunnel port, 1/1/g1 will be converted to IP interface with the alias, "giga_auto_tunnel_1_1_g1".

Moreover, the ARP/NDP timer settings will be moved from GigaSMART to control card. The ARP/NDP timer value is 3-30 seconds. If you had configured the ARP/NDP timer settings for more than 30 seconds, it will be decreased to 30 seconds after the upgrade.

Configure IP Interface

Before you configure an IP interface, you must:

- Configure a network and a tool port.
- Create a GigaSMART group and NetFlow exporter.

NOTE: You can associate multiple GigaSMART engines to a GigaSMART group.

To create an IP interface associated with a network port, do the following:

1. On the top navigation pane, click **Physical**.
2. In the Physical Nodes page, select the node for which you want to configure the IP interface.
3. From the left navigation pane, go to **Ports > IP Interfaces**.
4. In the IP Interfaces page, click **New**. The IP Interface page opens.

The following table provides a description of the fields on the IP Interfaces page.

Field	Description
Type	Tool port address type. Options: IPv4 and IPv6
IP Address	Specify the IP address for the IP interface.
IP Mask	Specify the IP Mask for the IP interface using the format: 255.255.255.255
Gateway	Specify the IP address of the Gateway for the IP interface.
MTU	Specify the MTU for the IP interface (100 - 9600 bytes). The MTU for ports is fixed at 9600 for all network/tool ports on the following platforms: <ul style="list-style-type: none"> • GigaVUE-HB1 • GigaVUE-TA1, GigaVUE-TA10, and GigaVUE-TA40 • Certified Traffic Aggregation White Box The MTU is fixed at 9400 for all network/tool ports on the following platforms: <ul style="list-style-type: none"> • GigaVUE-HC2 and GigaVUE-HC2 equipped with Control Card

Field	Description
	version 2 (HC2 CCv2) <ul style="list-style-type: none"> • GigaVUE-HC1 • GigaVUE-HC3 • GigaVUE-TA100, GigaVUE-TA100-CXP, and GigaVUE-TA200 RECOMMENDATION: Set the MTU to 9400 on all platforms.
GS Group	Use the drop-down menu to assign decapsulation for this IP interface to one of the configured GS Groups.

5. In the **Alias** and **Comment** fields, enter a name and description for the IP interface.
6. From the **Ports** drop-down list, select the tool or the network port that you had configured.
 - a. In the **Port** field, start by using the Box ID and Slot ID fields to select the line card with the port you want to use for the tunnel.
 - b. From the list of available ports, selected the network port. You can select a maximum of one port.
7. Enter the **IP Address**, **IP Mask**, **Gateway**, and **MTU** for the IP interface.

You can specify the subnet mask using either of the following formats:

 - netmask – For example, 255.255.255.248
 - mask length – For example, /29
8. From the **GS Groups** drop-down list, select the GigaSMART groups that you have created.

NOTE: You can associate multiple GigaSMART groups to the IP interface.

9. From the **Exporters** drop-down list, select the NetFlow exports that you have created.
10. Click **OK** to create the IP interface associated with a network or tool port and add it to the list of currently configured IP interfaces.

Circuit Tunnels

Circuit tunnels are used to route traffic between two clusters. The traffic is tapped and sent through network ports on the TAP landing nodes in a cluster. Based on the flow map configuration, traffic is filtered at the TAP landing nodes and sent to the circuit ports. The circuit ports encapsulate the traffic with a Circuit ID and routes the encapsulated traffic through a circuit tunnel. At the receiving end, the traffic is decapsulated and sent to the tool ports. The circuit tunnels are bidirectional. For more information about circuit tunnels, refer to [About Circuit-ID Tunnels](#).

Port Discovery

This section describes port discovery for the GigaVUE H Series, providing information about discovery protocols and how to enable discovery through GigaVUE-FM. For details refer to the following:

- [Port Discovery with LLDP and CDP](#)
- [Enable Port Discovery](#)
- [Port Discovery Support](#)

Port Discovery with LLDP and CDP

The GigaVUE H Series is capable of snooping Link Layer Discovery Protocol (LLDP) packets and Cisco Discovery Protocol (CDP) packets. If the devices in your network use either of these protocols, a GigaVUE H Series node can identify its immediate neighbors and their capabilities. Snooped LLDP and CDP information includes the remote port and chassis IDs, as well as other selected information, if it is included by the sender. This information can be used to determine the origin of traffic flows.

All GigaVUE H Series and TA Series nodes support LLDP and CDP port discovery,

LLDP and CDP are physical topology discovery protocols (Layer 2). The protocols are unidirectional. Devices send their identity and capabilities in a packet. The GigaVUE H Series node receives the packet and extracts information from it, such as the chassis ID and port ID of a neighbor. The information from the neighbors varies depending on what is sent in the packet.

An LLDP packet supports the following capabilities in a type-length-value (TLV) structure. The first four capabilities are mandatory.

- Chassis ID
- Port ID
- Time-to-Live (TTL)
- End of TLVs
- Port description
- System name
- System description
- System capabilities available
- System capabilities enabled
- VLAN name
- Management address

- Port VLAN ID
- Management VLAN ID
- Link Aggregation port ID
- Link Aggregation status
- Maximum Transmission Unit (MTU)

A CDP packet supports the following capabilities in a TLV structure:

- Device ID
- Port ID
- Platform
- Software version
- Native VLAN ID
- Capabilities
- Network prefix address
- Network prefix mask
- Interface address
- Management address

The LLDP/CDP discovery packets are copied and parsed by the GigaVUE H Series node, and the neighbor information is cached. Discovery packets are not terminated on the GigaVUE H Series node, nor are they removed from the ingress data stream.

Notes:

- Port discovery can be enabled on network, tool, and circuit type ports.
- Use port discovery on ports fed by SPAN ports or aggregators with caution. LLDP/CDP information received from a SPAN port may be misleading, depending on how it is configured. When a large range of ports are SPANed, different and conflicting LLDP/CDP information may be received. LLDP/CDP is best used on TAPed network interfaces.

Enable Port Discovery

Port discovery is disabled by default. It can be enabled on network, tool, and circuit type ports.

NOTE: The ports do not have to be included in a map.

1. Select **Ports > All Ports**.
2. On the Ports page, click on the Port ID of the port on which you want to enable port discovery.

The Quick View window displays for the port ID.

3. Select **Edit** from the top right corner of the Quick View Window.
4. To enable ports discovery do the following under **Ports Discovery**:
 - a. Select **Enable**
 - b. For Discovery Protocols, select one of the following: **All**, **LLDP**, or **CDP**.

[Figure 203: Enable and Configure Discovery Protocol](#) shows ports discovery enabled using the LLDP protocol for the port 1/2/x1.

5. Click **Save**.

Figure 203: Enable and Configure Discovery Protocol

Limits of Discovery Information

The following are limits on the amount of discovery information that is retained:

- For each port, discovery information for a minimum of two neighbors and a maximum of 20 neighbors is retained.
- For a chassis, discovery information for a maximum of 2K neighbors is retained.

Neighbor information will be removed or replaced as follows:

- when the neighbor information expires due to the TTL
- when the number of neighbors for the chassis reaches the 2K maximum and a new neighbor is discovered. In this case, the following can occur:
 - if there are currently two or more discovered neighbors for a port, the newly discovered neighbor will replace the neighbor information for the least recently updated neighbor
 - if there are currently less than two discovered neighbors for a port, the newly discovered neighbor will be added (actually exceeding the 2K limit in order to guarantee a minimum of two neighbors per port)

NOTE: Aging (the discovery protocol time-to-live) determines how long neighbor information is valid.

Port Discovery Support

This section describes port discovery for a cluster and port discovery for SNMP.

Port Discovery for a Cluster

LLDP and CDP discovery can be enabled on any network, tool, or circuit ports in a cluster. The discovery information will be aggregated and available on the cluster master.

Port Discovery Supported for SNMP

The information from LLDP discovery is supported in the standard MIB and can be retrieved with SNMP **Get**.

The name of the MIB file that needs to be loaded in order to poll the LLDP information with SNMP is as follows:

- LLDP-MIB

The information from CDP discovery is supported in Cisco private MIBs and can be retrieved with SNMP **Get**.

The names of the Cisco MIB files that need to be loaded in order to poll the CDP information with SNMP are as follows:

- CISCO-CDP-MIB
- CISCO-SMI
- CISCO-SMI-MIB
- CISCO-TC
- CISCO-TC-MIB
- CISCO-VTP-MIB

Ingress and Egress VLAN

This section describes ingress port VLAN tagging and egress port VLAN stripping. Refer to the following sections for details:

- [About Ingress Port VLAN Tagging](#)
 - [Ingress Port VLAN Tagging](#)
 - [Adding VLAN Tags](#)
 - [Deleting VLAN Tags](#)
- [Using VLAN Tags in Maps](#)
- [Ingress Port VLAN Tag Limitations](#)
 - [Second Level Maps](#)
 - [Double-Tagged Packets](#)
 - [IP Interfaces](#)

- [Configure Egress Port VLAN Stripping](#)
 - [Enable Egress Port VLAN Stripping](#)
 - [Disable Egress Port VLAN Stripping](#)
 - [Display Egress Port VLAN Stripping](#)
- [Egress Port VLAN Stripping Limitations](#)
- [How to Use Both Ingress Tagging and Egress Stripping](#)

About Ingress Port VLAN Tagging

You can add VLAN tags to ingress packets on a per-port basis. You manually associate VLAN IDs with specific ports of type network or inline-network.

Use VLAN tags to identify, differentiate, or track incoming sources of traffic. When the traffic reaches the tools or the maps, you can filter on the VLAN tags for the corresponding ports you want to measure.

Ingress port VLAN tagging is supported for IPv4 and IPv6 packet types, including non-tagged packets, tagged packets, and Q-in-Q packets. Ingress port VLAN tagging is not supported on hybrid ports or on network ports that are connected via port-pairs.

Each port can only have one VLAN tag. The same VLAN tag can be assigned to multiple network ports or to both ports in an inline network port pair. For details on VLAN tagging for inline network groups, refer to [Configurable VLAN Tagging](#).

VLAN tagging is supported in a cluster.

Refer to [Figure 204: Using Ingress Port VLAN Tagging](#) for an example. In the example, traffic from San Jose is tagged with VLAN 1001 and traffic from San Francisco is tagged with VLAN 1002.

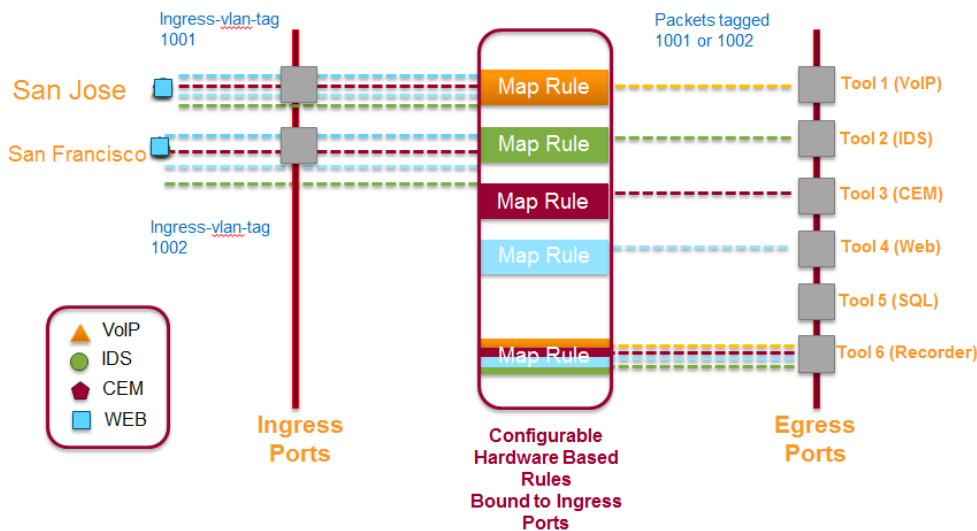


Figure 204: Using Ingress Port VLAN Tagging

Ingress Port VLAN Tagging

The port type must be a network or inline network type of port. Each network port can only have one VLAN tag. Once a VLAN tag is configured, it can be modified by overriding the existing one with a new VLAN ID.

The VLAN ID is specified in the **VLANTag** field of the port configuration page for an network or inline network port. The value of the VLAN ID is specified as a number between 2 and 400.

Adding VLAN Tags

To add/modify VLAN tags, follow these steps:

1. Select **Ports** in the main navigation pane.
2. Select **Ports > All Ports** in the top navigation bar.
3. Click on the **Port ID**. Ensure that this Port ID is set as a network port.
The Quick View window for the Port ID displays.
4. Select **Edit** from the top right corner of the Quick View Window.
5. Add the **VLAN ID** to the parameter field **VLAN Tag** and click **Save**.

The screenshot shows the configuration page for a port. At the top, there is an 'Alias' field. Below it is a 'Parameters' section with a dropdown arrow. The parameters are as follows:

- Admin:** Enable
- Type:** Network (dropdown)
- Speed:** 10G (dropdown)
- Duplex:** Full Half
- Auto Negotiation:** Enable
- VLAN Tag:** (empty text field)
- Force Link Up:** Enable
- Timestamp:**
 - Append Ingress
 - Strip Egress
 - Source ID Egress 1-65535

Figure 205: H-VUE Screen for Port-ID Configuration

Deleting VLAN Tags

Once a VLAN tag is configured, it can be deleted by removing the value from the **VLANTag** field and saving the port configuration.

Using VLAN Tags in Maps

Ingress port VLAN tags are supported in first level maps, including the following:

- map
- map-passall
- map-scollector
- GigaSMART operation (gsop-enabled) maps

For example, if the traffic from network port 2/1/q3, (which has VLAN tag 1001 configured), is forwarded to tool port 2/1/q4. The traffic at tool port 2/1/q4 will have the added VLAN tag 1001. (Even though the VLAN tag is configured on the network port, it is added when the traffic exits the tool port.)

NOTE: Traffic from a network port will not match a map rule that filters on a VLAN tag configured on the network port.

Ingress Port VLAN Tag Limitations

The following sections describe limitations of ingress port VLAN tagging:

- [Second Level Maps](#)
- [Double-Tagged Packets](#)
- [IP Interfaces](#)

Second Level Maps

VLAN tagging is not supported for second level maps, which are maps from a virtual port (vport).

For tagged network ports, if the ingress traffic is going to a second level map, the packets will not be tagged at the egress ports of the second level map. This is a limitation of GigaSMART operations using maps with vports.

Double-Tagged Packets

If incoming packets already have two VLAN tags, such as with Q-in-Q, the addition of a third VLAN tag can cause problems with the following:

- Layer 3/Layer 4 filtering
- GigaStream hashing (all packets may be sent to only one tool port)

IP Interfaces

For IP interfaces, a VLAN tag added at the network port of the encapsulation path (n1 in [Figure 206: IP Interfaces](#)) will become part of the payload going to the decapsulation path. But a VLAN tag added at the network port of the decapsulation path (n2 in [Figure 206: IP Interfaces](#)) will be available at the end tool port for filtering (t2 in [Figure 206: IP Interfaces](#)).

Refer to [Figure 206: IP Interfaces](#). VLAN tag (vlan1) added at the encap network port (n1) is encapsulated in the tunnel payload and cannot be used for filtering at the decap side. VLAN tag (vlan2) added at the decap network port (n2) can be used in a filter rule to send packets to tool port (t2).

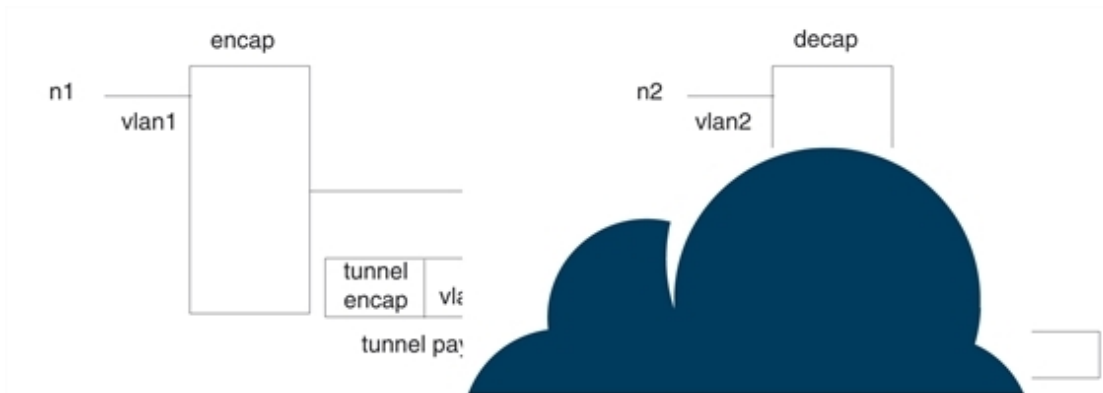


Figure 206: IP Interfaces

Configure Egress Port VLAN Stripping

You can enable or disable outer VLAN stripping on specified egress ports. The port type must be tool or hybrid.

Use egress port VLAN stripping to strip an outer VLAN tag without using a GigaSMART stripping operation.

Enable Egress Port VLAN Stripping

To enable egress port VLAN stripping:

1. Select a tool or hybrid port on the Ports page. t
2. Click **Edit**.
3. Under Parameters, for Egress Vlan Tag, select Strip. Refer to [Figure 207: Select Strip Egress Vlan Tag](#).

The screenshot shows a configuration window with the following settings:

- Admin:** Enable
- Type:** Tool (dropdown menu)
- Speed:** 10G (dropdown menu)
- Duplex:** Full, Half
- Auto Negotiation:** Enable
- Egress Vlan Tag:** None, Strip
- Force Link Up:** Enable

Figure 207: Select Strip Egress Vlan Tag

4. Click **OK**.

Disable Egress Port VLAN Stripping

Once egress port VLAN stripping is enabled, it can be disabled. In [Figure 207: Select Strip Egress Vlan Tag](#), for Egress Vlan Tag, select None.

Display Egress Port VLAN Stripping

To display egress port VLAN stripping configuration:

1. Double-click a tool or hybrid port on the Ports page.
2. View the configuration under Port Info.

Egress Port VLAN Stripping Limitations

The following are limitations of egress port VLAN stripping:

- Enabling both ingress port VLAN tagging and egress port VLAN stripping on the same port is not supported.
- Egress port VLAN stripping does not support inline tool ports or stack ports.
- Egress port VLAN stripping is not supported on the following: GigaVUE-HB1 nodes.
- If a port is configured for egress port VLAN stripping, configuring a port filter with either pass or drop VLAN rules is not recommended.
- Egress port VLAN stripping with outer tag ethertype of 0x88A8 or 0x9100 is supported if the tool port is local to the network port node (in the case of clustering). An outer tag of ethertype 0x8100 works without any limitation when egress port VLAN stripping is used in conjunction with ingress port VLAN tagging on the upstream GigaVUE node.

How to Use Both Ingress Tagging and Egress Stripping

When ingress port VLAN tagging is enabled on a network port and egress port VLAN stripping is enabled on a tool port on the same GigaVUE node, refer to the [Table 32: VLAN Stripping Table](#):

Table 32: VLAN Stripping Table

Tool →	Stripping Enabled			Stripping Disabled		
Network	Untagged	Single Tag	Double Tag	Untagged	Single Tag	Double Tag
Ingress VLAN tag enabled	None	None	Customer VLAN tag	Ingress VLAN tag	Ingress VLAN tag + Customer VLAN tag	Ingress VLAN tag + Customer VLAN tag + Service VLAN tag
Ingress VLAN tag disabled	None	None	Customer VLAN tag	None	Customer VLAN tag	Service VLAN tag

NOTES:

- The inner VLAN tag is classified as the Customer VLAN tag (ethertype 0x8100)
- The outer VLAN tag is classified as the Service VLAN tag (ethertype 0x8100, 0x88A8, or 0x9100)

How to Use GigaStream

This section describes how to create and manage GigaStream. A GigaStream groups multiple ports into a logical bundle. Refer to the following sections for details:

- [About GigaStream](#)
- [Regular GigaStream](#)
- [Controlled GigaStream](#)
- [Advanced Hashing](#)
- [Weighted GigaStream](#)
- [GigaStream Rules and Maximums](#)

About GigaStream

There are two types of GigaStream: regular GigaStream and controlled GigaStream. Both types of GigaStream bundle multiple ports to provide logical bandwidth. Packets arriving through network ports are processed with various map rules and then directed to ports. All traffic streams destined to a GigaStream are hashed among the bundled ports.

Regular GigaStream groups multiple ports running at the same speed into a single logical bundle called a GigaStream. Regular GigaStream can be used as either a packet egress destination (tool GigaStream) or as a stack-link between two GigaVUE-OS nodes operating in a cluster (stack GigaStream).

NOTE: The existing tool and stack GigaStream are now referred to as regular GigaStream. The term GigaStream is used when something applies to both types

For details on regular GigaStream, refer to [Regular GigaStream](#).

Controlled GigaStream provides GigaStream controlled traffic distribution. Controlled GigaStream samples traffic based on hash settings and helps to ensure that traffic sent to each tool is within the capacity of the tool.

For details on controlled GigaStream, refer to [Controlled GigaStream](#).

Controlled GigaStream provides greater flexibility in allocating the bandwidth assigned to tools within the GigaStream. Regular GigaStream assumes that each tool in the GigaStream is sent an equal fraction of the traffic. Controlled GigaStream allows different tools to be sent different fractions of the traffic.

Regular GigaStream and controlled GigaStream differ in the following ways:

- how traffic is distributed based on hashing
- how traffic fails over when a port goes down
- how the configuration can be edited, such as adding ports on the fly

Regular GigaStream

Regular GigaStream can be used as either a packet egress destination (tool GigaStream) or as a stack-link between two GigaVUE-OS nodes operating in a cluster (stack GigaStream).

All ports in a GigaStream must be running the same speed, such as 10Gb or 40Gb, and must use the same port type, either tool or stack. All ports in a GigaStream can be on different modules of the same GigaVUE-HC2 or GigaVUE-HC3 node.

With regular GigaStream, the hashing is computed based on traffic. Incoming packets arriving through network ports are processed with various map rules and then directed to ports. The result of the hash distributes traffic equally across the GigaStream members. Refer to [Figure 208: Regular GigaStream Overview](#).

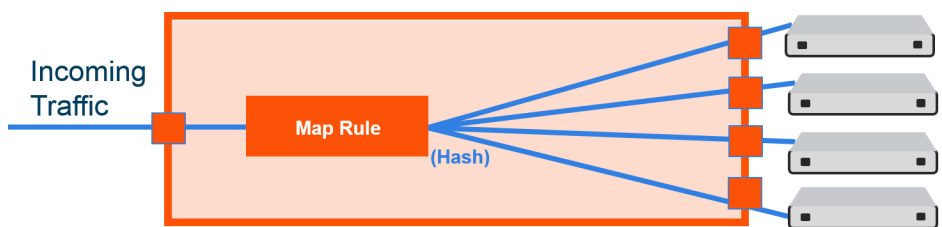


Figure 208: Regular GigaStream Overview

With the advanced hashing mode, the hash is a result of multiple parameters such as source MAC address, destination MAC address, source IP address, destination IP address, protocol, or other criteria. The hashing algorithm determines the destination tool port for a particular packet. All packets matching a particular set of hashing criteria will be sent to the same port. Sessions are maintained within a stream.

For example, a regular tool GigaStream is configured with ports x1 to x4. The hash table of size 4 is evenly divided among the 4 ports, and the traffic is distributed accordingly. For more information on how traffic is distributed with regular GigaStream, refer to [Traffic Distribution Across Controlled GigaStream](#).

Regular Tool GigaStream

A regular tool GigaStream can be used as a single addressable destination, allowing you to overcome tool port oversubscription issues.

NOTE: A regular tool GigaStream can consist of tool ports or hybrid ports.

Refer to [Figure 209: Regular Tool GigaStream Illustrated](#).

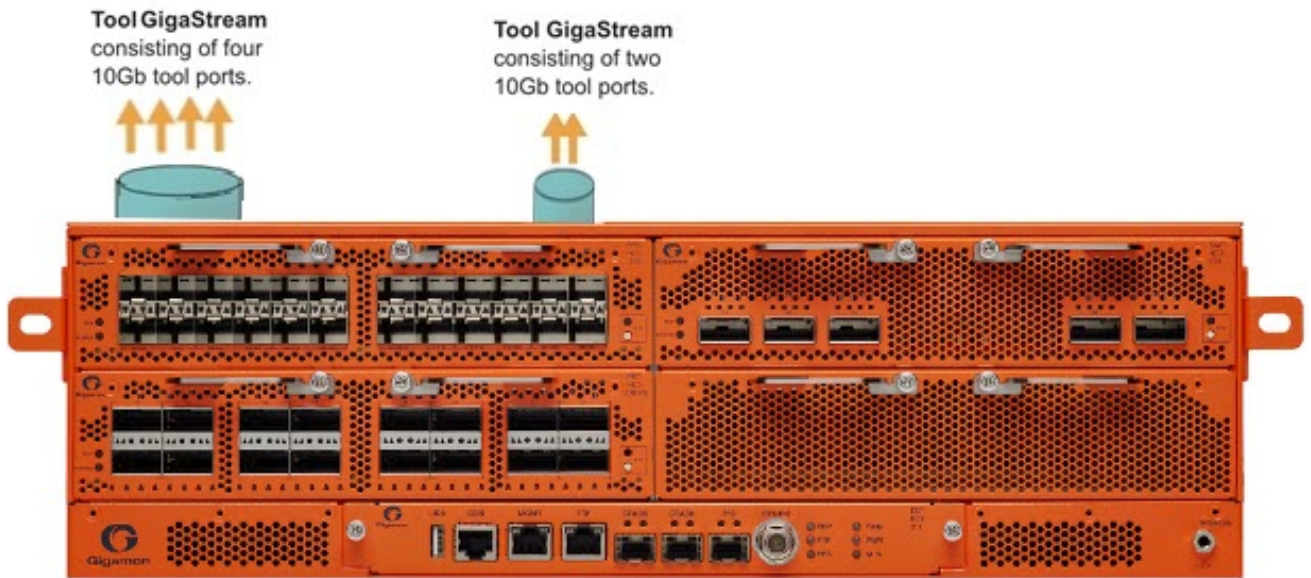


Figure 209: Regular Tool GigaStream Illustrated

Regular Stack GigaStream

A regular stack GigaStream can use stack-links to distribute data between GigaVUE-OS nodes operating in a cluster. With the terabits of throughput possible in a GigaVUE H Series node, using only one 10Gb port for a stack-link could cause a bottleneck. A regular stack GigaStream dramatically increases the bandwidth available for stack-link connections, providing greater flexibility and throughput within a cluster.

Refer to [Figure 210: Regular Stack GigaStream Illustrated](#).

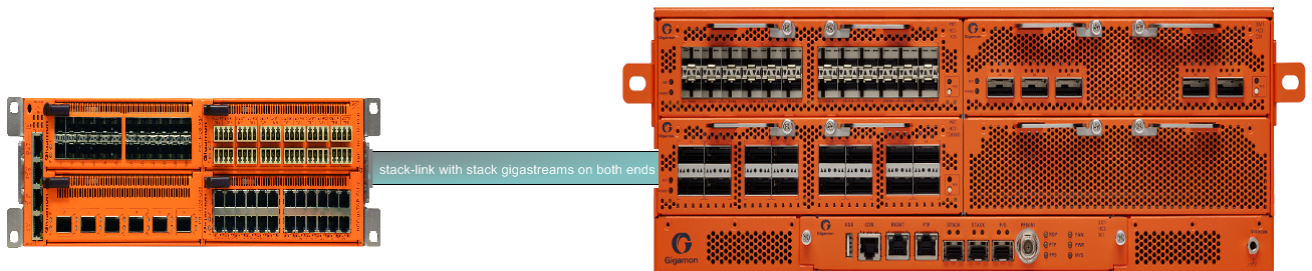


Figure 210: Regular Stack GigaStream Illustrated

Configure Regular GigaStream

All ports combined in a GigaStream must be running at the same speed, using the same port types. Port speeds less than 1000Mb are not supported.

Also, refer to [Advanced Hashing](#) for optional advanced hashing settings and [Weighted GigaStream](#) for optional weighting settings.

Before you configure a regular GigaStream, ensure that you have configured the required ports—tool, hybrid, stack, or Circuit. For information about configuring a port, refer to [Configure Ports](#).

To configure a regular GigaStream:

1. On the top-navigation link, go to **Physical > Physical Nodes**.
2. In the Physical Nodes page, click the required cluster ID for which you want to configure a regular GigaStream.
3. On the left-navigation pane, go to **Ports > Port Groups > GigaStream™**.
4. Click New. The **GigaStream™** page appears.
5. In the Alias and Comment fields, enter the name and description of the regular GigaStream that you want to configure.

6. Select the type of GigaStream that you want to configure. For example, if you want to configure a regular tool GigaStream, select **Tool GigaStream**.
7. From the **Ports** drop-down list, select the ports that you have configured. For example, select the required hybrid ports to configure a regular hybrid GigaStream.
8. From the **Weighting** drop-down list, select one of the following options:
 - **Equal**—Traffic is distributed equally to all the ports in the regular GigaStream.
 - **Relative**—Traffic is distributed to the ports in the regular GigaStream based on the relative weight or ratio assigned to the respective ports. The valid range is 1–256.
 - **Percentage**—Traffic is distributed to the ports in the regular GigaStream based on the percentage assigned to the respective ports. The valid range is 1–100.

If you select **Relative** or **Percentage** as the weighting option, enter the hash weights for the ports that appear in the table below the **Weighting** drop-down list.

9. In the **Drop Weight** field, enter the relative weight to drop the traffic. For example, if you enter 2 in this field, 2% of the total traffic entering the regular GigaStream will be dropped.

NOTE: The **Weighting** and the **Drop Weight** fields are not available when you configure a regular stack GigaStream.

For example, you want to send only 25% of the traffic to a tool group with four tool ports, 1/1/c1..c4. Depending on the Weighting option you choose, enter the hash weights as follows:

- **Relative**—Enter the hash weights for the ports as 1 for 1/1/c1..c4 and **Drop Weight** as 12. This means that the traffic, 1/16 goes to tool port 1/1/c1, 1/16 goes to tool port 1/1/c2, and so on. 12/16 traffic gets dropped.
- **Percentage**—Enter the hash weights for the ports in percentage. 6% for 1/1/c1..c4 and **Drop Weight** as 76%. This means that 6% of the traffic goes to tool port 1/1/c1, 6% goes to tool port 1/1/c2, and so on. 76% of the traffic gets dropped.

10. Click **OK** to save the configuration.

The configured regular GigaStream appears in the table in the GigaStream™ page.

Edit Regular GigaStream

Starting with software version 5.4, GigaSMART provides support for editing a regular GigaStream. You now have the benefit of adding and deleting tool ports from GigaStreams without the need to recreate the GigaStream with a new map.

Support is available to edit Tool and Hybrid GigaStream's attached to the following maps types:

1. Level one GS map

2. 2nd level GS map (includes GTP overlap sampling maps)
3. Regular map (including port mirroring, collector, etc.)

NOTE: Regular GigaStream and controlled GigaStream are interchangeable. You can change the type of GigaStream from regular to controlled in real-time.

To edit a regular tool GigaStream attached to a map:

1. Select **Ports > Port Groups > GigaStreams**.
2. Select a GigaStream and click **Edit** to open the GigaStream configuration page.
3. Click in the **Ports field** and **Change, Add** or **Delete** tool ports associated with the GigaStream as needed.
4. Click **OK**.

Edit Regular Stack GigaStream

You can edit regular stack GigaStreams that are configured on either sides of a stack link. When a stack GigaStream is attached to a map, you can directly add or delete stack ports from the stack GigaStream.

To edit a regular stack GigaStream:

1. On the top-navigation link, go to **Physical > Physical Nodes**.
2. In the Physical Nodes page, click the required cluster ID.
3. On the left-navigation pane, go to **Ports > Stack Links**. The Stack Links page appears.
4. Select the alias of the stack link that is grouped in the stack GigaStream that you want to modify, and then click **Edit**. The Stack Link page appears.
5. From the **Ports** drop-down list, add or delete the required stack ports, and then click **OK**.

Traffic Distribution Across Regular GigaStream

All the traffic streams destined to the GigaStream are distributed among the bundled ports based on hashing, as defined in the advanced hash settings or Weighted GigaStream, as defined in the **Weighting** field.

The hash is performed across multiple fields, such as IP address, port number, protocol, MAC address, and other criteria. The best practice is to include both the source and destination fields, such as source IP address and destination IP address, within the advanced hash settings. Because the hash calculation is symmetrical with respect to source and destination addresses, all packets belonging to the same session will be sent to the same tool.

For more information on hashing, refer to [Advanced Hashing](#).

The GigaVUE-OS nodes distribute traffic between the ports in a regular GigaStream using one of the following criteria:

- The criteria configured using the Advanced Hash Setting page for the selected line card or chassis. (Click **Advanced Hash Setting** on the GigaStream page to open the Advance Hash Setting.) Because traffic is hashed across member ports rather than divided evenly, the bandwidth available for a regular GigaStream is not a straight multiple of the number of ports in the bundle – some flows will use more bandwidth than others.

NOTE: The GigaVUE H Series node tries to distribute incoming traffic evenly across all tool ports in the GigaStream. However, live network traffic is often unpredictable, including bursty periods for certain sessions. Because of this, the distribution patterns described are not ironclad – variations in traffic will result in variations in distribution.

The distribution described in this section applies to GigaVUE-HC2 and GigaVUE-HC3 modules, GigaVUE-HC1 nodes, and GigaVUE TA Series nodes for regular tool GigaStream and regular stack GigaStream.

- Weighting mode and hash weights assigned to the different ports in the regular GigaStream. For more information about Weighted GigaStream, refer to [Weighted GigaStream](#).

Regular GigaStream Failover Protection—Resiliency

Regular GigaStream has built-in failover protection or resiliency. When there is a failover of a port that is part of a regular GigaStream, the traffic is redistributed to the other tool ports without disturbing the session continuity.

When a tool port goes down, the sessions allocated to the failed port are redistributed among the remaining available ports. With the resiliency functionality, the redistribution of traffic occurs without disturbing the session continuity of the active ports.

Recovery of a regular GigaStream is automatic. When a down link returns, the traffic will be reassigned to their original ports automatically.

The resiliency functionality is supported on all GigaVUE HC Series, and TA Series nodes and on Hybrid GigaStream, Tool GigaStream, and Circuit GigaStream.

Add or Remove Port in Regular GigaStream

When a port is removed from a regular GigaStream, only the session allocated to that particular port is redistributed to other available ports in the GigaStream.

When a new tool port is added to the regular GigaStream, the system does not rehash all the sessions. Instead, a fraction of the hash values is moved from the original tools to the new tool.

When you add a healthy port to a regular GigaStream, which has few ports that are in the down state, the hash buckets of the down ports need to be assigned to the newly added port. When the down ports resume after the failure, the hash buckets need not be reassigned to the ports.

Add Down Port in GigaStream

When a down port is added to a regular GigaStream, no sessions are assigned to the new port until the port is up. This prevents the session loss to any existing tools, when the port is added to the GigaStream.

When the port becomes active, the sessions are allocated to the new port.

Remove Down Port in GigaStream

When a port goes down in a regular GigaStream, the sessions corresponding to the down port are distributed to the remaining ports. When you remove the down port from the GigaStream, then the hash values added from this port of the GigaStream becomes the original values of other ports.

Controlled GigaStream

Controlled GigaStream provides controlled traffic distribution, which gives more granular control over hashing to the tool ports.

All GigaVUE H Series and TA Series nodes support controlled GigaStream, with the following distinctions:

- GigaVUE-HB1 is not supported.

GigaVUE nodes with controlled GigaStream are supported in a cluster environment.

Controlled GigaStream can only be used as a packet egress destination (tool GigaStream). All port speeds are supported.

With controlled GigaStream, the hashing is computed based on traffic. There is a configurable number of hash buckets, from 1 to 256. The hash size of a controlled GigaStream specifies the number of logical tools the traffic will be distributed across. Refer to [Figure 211: Controlled GigaStream Overview](#).

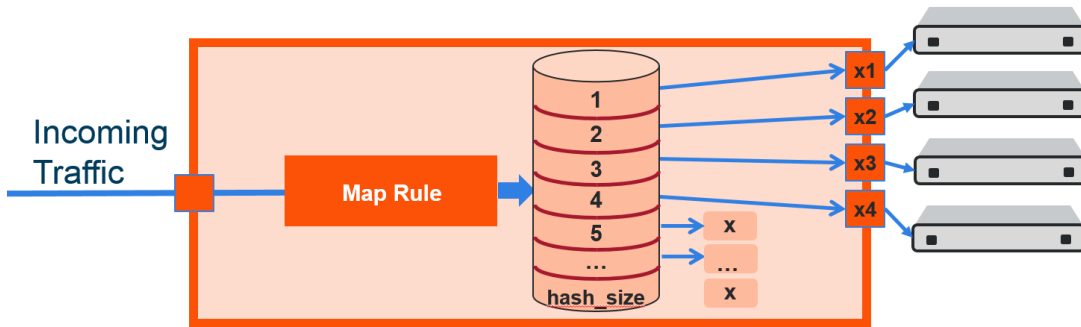


Figure 211: Controlled GigaStream Overview

Controlled GigaStream can manage network port bandwidth hashed to GigaStream tool ports. For example, if there is 10Gb of distributed traffic coming in on network ports directed to a GigaStream, and the tools connected to each tool port of the GigaStream can handle only 2Gb of bandwidth, the GigaStream can distribute the streams to 5 tool GigaStream ports. The ingress bandwidth divided by the number of tools determines the number of hash buckets.

Not all hash buckets need to be mapped to ports. In [Figure 211: Controlled GigaStream Overview](#), four buckets are mapped to ports, while the remaining buckets are black holed. This provides a form of sampling, that is, only a sample of traffic is sent to the tools.

To determine the best hash size to use for your monitoring needs, divide the maximum bandwidth being sent to the tools by the bandwidth that can actually be consumed by the tools. For example, if you have 150 Gb of traffic, but the tools can only process 3 Gb, the recommended hash size is $150/3 = 50$. To have completely even distribution across the logical tools, round up to the nearest power of 2. In this example, round up a hash size to 64.

When you have more bandwidth than the tools can process, you can use controlled GigaStream to restrict the amount of traffic sent to each tool. The hash size is determined by:

- the amount of traffic to be monitored, for example 300Gb
- the maximum bandwidth of the monitoring tools, for example 2.5Gb

Then divide ($300/2.5=120$), and round up to a power of 2 (for example, 16, 32, 64, 128). In this case, the hash size would be 128.

Another use for a controlled GigaStream is to increase the reliability of tool ports. For example, a trunk size of 5 is configured on 4 ports with 1 hash bucket each, port x1 is allocated or mapped to hash bucket ID 1, port x2 is mapped to hash bucket ID 2, port x3 is mapped to hash bucket ID 3, and port x4 is mapped to hash bucket ID 4. Hash bucket ID 5 is not mapped to a port. It can be reserved to be mapped to a port later. Until then, any traffic hashed to bucket 5 will be black holed. Refer to [Figure 212: Controlled GigaStream Example](#).

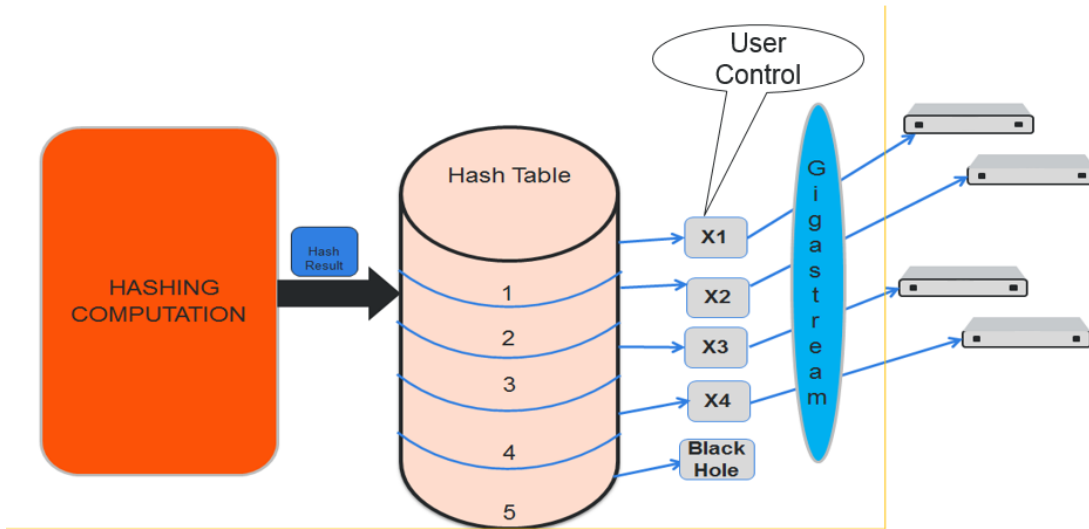


Figure 212: Controlled GigaStream Example

Generally, if there are only four tools available, with controlled GigaStream, a GigaStream trunk size of 5 can be configured and allocated to the available four tool ports of the GigaStream. The fifth tool port can be reserved and you can attach that port to the GigaStream whenever it is needed. The existing traffic streams are not impacted.

GigaStream controlled traffic distribution provides enhanced control of traffic hashed across the trunk ports as compared to regular GigaStream. The GigaStream trunk size is configurable, and ports can be dynamically added and deleted.

To configure controlled GigaStream, there are two parameters needed as follows:

- the hashing trunk size, which defines the number of hash buckets to be configured. It defines the maximum number of hash bucket IDs, from 1 to 256.
- the hash bucket ID, which specifies the mapping to ports. Each member of the trunk is mapped to a hash bucket ID. Mapping a port to a hash bucket ID makes it part of a GigaStream. The mapping to ports is static. When a port goes down, traffic is not re-hashed to the remaining ports.

In general, a controlled GigaStream is defined with a hash size equal to the number of trunk ports expected. Mapping a hash bucket ID to each trunk port will evenly distribute the traffic among the ports.

A particular trunk member can be mapped to multiple hash bucket IDs. If one tool can handle 4Gb, 2 hash bucket IDs can be mapped to that tool port. A trunk member that is configured to two hash

bucket IDs will be two times more likely to receive hashed traffic as compared to a trunk member with one hash bucket ID. Thus, more traffic can be sent to the higher capacity tools in the GigaStream.

NOTE: A hash bucket ID cannot be mapped to multiple ports.

For more information, refer to [Traffic Distribution Across Controlled GigaStream](#).

Notes and Considerations for Controlled GigaStream

Refer to the following notes and considerations for controlled GigaStream:

- Controlled GigaStream can be used with a regular map, map-passall, or map-scollector.
- Controlled GigaStream supports tool ports, but not inline tools or inline tool groups.
- Controlled GigaStream does not support stack or hybrid port types.
- Controlled GigaStream does not support a GigaSMART operation (gsop), or the first and second level maps associated with it.
- The maximum hash size is 256 per trunk.
- All the tool ports participating in the GigaStream must be on the same node. GigaStream can be created across GigaVUE-HC2 or GigaVUE-HC3 modules.
- All participating ports in the GigaStream must be running the same speed and must use the same port type.
- A **Controlled GigaStream** checkbox is used on the GigaStream configuration page for controlled GigaStream, enabling the prefix mode for specifying hash size and hash bucket IDs.
- Before attaching a controlled GigaStream to a map, it should be configured with at least one port.
- Controlled GigaStream can be modified on the fly, even after it is attached to a map. Refer to [Edit Regular GigaStream](#).
- If the GigaStream is already attached to a map, the last mapped hash bucket ID cannot be deleted. That is, do not delete all the ports from a controlled GigaStream.

Controlled GigaStream Configuration

To configure a controlled tool GigaStream, specify hash size and hash bucket ID.

Following are the steps to configure Controlled GigaStream:

1. Use the Quick Port Editor to configure ports as type tool for the controlled GigaStream.
2. Select **Ports > Port Groups > GigaStreams** and click **New** to open the GigaStreams configuration page.

3. Enter an name for the GigaStream in the **Alias** field. For example stream 2.
4. (Optional) Enter a comment in the **Comment** field. For example, controlled GigaStream.
5. For **Type**, select **Tool GigaStream**.
6. Select **Controlled GigaStream**. The **Port** field changes to **Hash Size**.
7. In the **Hash Size** field, specify a hash size value. The range is 1 through 256.

The hash size value determines the number of hash bucked IDs and ports available for assigning to the GigaStream. For example, in [Figure 213: Controlled GigaStream with Five Hash IDs and Port IDs](#), the Hash Size is set to 5 so the GigaStream page displays five Hash IDs and five Port ID fields.

The screenshot shows a configuration form for a GigaStream. The fields are as follows:

- Alias:** stream2
- Comment:** (empty)
- Type:** Tool GigaStream (selected), Hybrid GigaStream, Stack GigaStream
- Controlled GigaStream:**
- Hash Size:** 5

Below the Hash Size field, there is a table with two columns: Hash ID and Port ID.

Hash ID	Port ID
1	Select ports...
2	Select ports...
3	Select ports...
4	Select ports...
5	Select ports...

Figure 213: Controlled GigaStream with Five Hash IDs and Port IDs

8. Assign ports to the hash bucket IDs by clicking in each **Port ID** field and selecting a tool port. The example in [Figure 214: Ports Assigned to Hash Bucket IDs](#) assign tool ports to hash buckets 1 though 4. Hash bucket 5 has no port assigned to it.

The screenshot shows a configuration form for a GigaStream. The fields are as follows:

- Alias:** stream2
- Comment:** controlled-gigastream
- Type:** Tool GigaStream (selected), Hybrid GigaStream, Stack GigaStream
- Fall over Status:** Enable, Disable (selected)
- Controlled GigaStream:**
- Hash Size:** 5

Hash ID	Port ID
1	T 1/4/x4 x
2	T 1/4/x5 x
3	T 1/1/x17 x
4	T 1/1/x16 x
5	Select ports...

Figure 214: Ports Assigned to Hash Bucket IDs

9. Click **Save**.

After saving the controlled GigaStream, it appears on the GigaStreams page.

NOTE: For controlled GigaStream, the GigaStream page shows a Failover Status of disabled. When a port goes down, traffic is not re-hashed. Refer to [Failover and Controlled GigaStream](#).

Edit Controlled GigaStream

A controlled GigaStream can be edited, even when the GigaStream is attached to a map. Unlike regular GigaStream, you can make changes without deleting the map or the GigaStream.

You have the control to map unused hash bucket IDs to any tool port dynamically, without deleting the trunk. This modification of a tool port mapping to a hash bucket ID will not affect the streams flowing on the hash bucket IDs that are mapped to other ports. In addition, you can replace the mapping of any hash bucket ID to a port, dynamically.

If one of the GigaStream ports goes down, all the hash bucket IDs mapped to that port will be black holed until they are re-mapped to a new port, or until the port comes back up. This means that the packets sent to the remaining tools are unaffected.

If one port is receiving a lesser amount of bandwidth, the traffic can be reallocated to it. For example, if port x4 is underutilized, you have the control to reconfigure hash bucket ID 5 to also map to port x4. Then port x4 receives all the traffic that is hashed to hash bucket IDs 4 and 5.

You also have the flexibility to change the size of the trunk anytime, but this will require reprogramming of the whole hash table, so that might impact the existing streams.

Increasing the size of the trunk creates new hash buckets, which can be mapped to new or existing GigaStream tool ports. You can increase the bucket size per GigaStream. For example, if the bucket size is 4, you can increase it to 5.

If the size of the trunk has to be decreased, you have to take extra caution when releasing the hash bucket IDs gracefully, since they are mapped to GigaStream tool ports.

If you decrease the bucket size, empty out the bucket by unmapping buckets to ports. Also, do not reduce the hash size to less than the last occupied hash bucket ID.

NOTE: There is some packet drop associated with the following type of controlled GigaStream editing:

- adding a new port
- deleting an existing port
- changing the hash size

The Port Statistics page may display Discards in these cases, but not when additional buckets are added to the same port, or when a port goes down.

Traffic Distribution Across Controlled GigaStream

Controlled GigaStream has N buckets (where N is from 1 to 256) distributed across one or more ports, logical or physical.

Controlled GigaStream uses advanced hashing with 1 to 256 buckets. With controlled GigaStream, you define the number of buckets first, unlike with regular GigaStream.

Controlled GigaStream can manage network port bandwidth hashed to GigaStream tool ports. For example, if you are monitoring 500Gb traffic and have 10 tools, 50Gb per tool would be required. But if the tools cannot handle 50Gb, packets will be lost randomly.

With controlled GigaStream, first determine how much traffic the tools can process. For example, perhaps each tool can process 5Gb of traffic.

The formula is ingress bandwidth divided by tool capability. For example, $500\text{Gb}/5\text{Gb} = 100$ tools. But if you only have 10 tools, you create a controlled GigaStream of 100 logical tools or 100 logical hash buckets, and then map only 10 of them.

Taking the number of buckets and dividing it by 100 tools ($256/100 = 2.56$) results in some buckets of 3, some buckets of 2.

The recommendation is to round to an even divisor of 256 (2, 4, 8, 16, 32, 64, 128, or 256). In this example, instead of using 100, use 128, so each bucket will be 2 ($256/128 = 2$).

Hash buckets IDs are mapped to ports as follows:

Buckets	Ports
1	x1
2	x2
3	x3
4	x4
5	x5
6	x6
7	x7
8	x8
9	x9
10	x10
11	unmapped
...	unmapped
128	unmapped

The hashing to the 10 connected tools captures the traffic associated with those sessions.

There are no tools associated with the remaining buckets, so that traffic is black holed. Unlike regular GigaStream, you do not have to allocate ports to the remaining buckets.

Multiple buckets can be mapped to one physical port as follows:

Buckets	Ports
1	x1
2	x1
3	x2
4	x3
...	...

In this example, port x1 receives 5Gb of traffic, while ports x2 and x3 receive 2.5Gb each.

Note that the mapping does not have to be consecutive as follows:

Buckets	Ports
1	x1
2	x2
3	x3
4	x1
...	...

In this example, port x1 also receives 5Gb of traffic, while ports x2 and x3 receive 2.5Gb each.

Through the mapping of buckets to ports, you can control the overall distribution of traffic to a given port.

Failover and Controlled GigaStream

Unlike the regular GigaStream, failover will not be triggered during a port down event. With controlled GigaStream, there is no rehashing or redistribution of traffic. In other words, the sessions flowing to other tool ports will not be disturbed and do not risk becoming oversubscribed.

Controlled GigaStream maintains hashing. When a port goes down, traffic is not re-hashed, but is black holed. Unlike with regular GigaStream, you do not need to enable **Force Link Up** on ports in order to counteract the default failover protection.

Advanced Hashing

Both regular GigaStream and controlled GigaStream use advanced hashing, which lets you select the criteria on which the hash is based, such as source and destination IP address, source and destination MAC address, source and destination port, and protocol.

GigaVUE-OS nodes distribute traffic between the ports in a GigaStream based on the hashing criteria configured using the **Advanced Hash Settings** page for the selected line card or chassis.

GigaStream hashing is applicable for the following port types:

- Tool port
- Hybrid port
- Circuit port

To open the Advanced Hash Settings page, select **Ports > Port Groups > GigaStream** and click **Advanced Hash Settings**. (For more details, refer to [Advanced Hash Settings](#).) On the GigaVUE nodes, GigaStream hashing is per chassis, not per line card.

The **Advanced Hash Settings** let you select the different packet criteria used to send matching flows to the same destination port within a GigaStream.

By default, the GigaVUE H Series node hashes traffic based on source and destination IP addresses, IP protocol, and source and destination ports.

How to Change Advanced Hash Criteria

You can select the criteria for the advanced hash algorithm by using **Advanced Hash Settings**. The advanced hash method you specify is used for all GigaStream in place on the specified line card or chassis.

Advanced Hash Settings

The Advanced Hash Settings page is where criteria for the advanced hash algorithm is set. To open the page, select **Ports > Port Groups > GigaStream** and click **Advanced Hash Settings**.

The following table describes the fields in the Advanced Hashing Settings page.

Field	Description
Box	Identifies chassis to which the advanced algorithm will be applied.
Slot	Identifies the line card to which the advanced hash algorithm will apply. Each line card in certain GigaVUE H Series nodes has its own individual advanced hash algorithm. On GigaVUE-HC3, GigaVUE-HC2, GigaVUE-HC1, and GigaVUE-HB1, GigaStream hashing is per chassis, not per line card. For example, the slot field will only shown cc1 when configuring an GigaVUE-HC2.
Default	Sets the advanced hash algorithm to its default settings. By default, the advanced hash algorithm includes source/destination IPv4/IPv6 addresses and ports.

Field	Description
Custom	Clears the field from the advanced has and allows you to select specific own criteria.
All	Selects all criteria.
None	Clears all fields from the advanced hash.
IPv4	<p>This area of the page lets you select the following criteria:</p> <ul style="list-style-type: none"> • IPv4 Source Address—Adds IPv4 source IP • IPv4 Destination Address—Adds IPv4 destination IP • IPv4 Protocol—Adds IPv4 protocol • IPv4 Source Port—Adds IPv4 source port • IPv4 Destination Port—Adds IPv4 destination port
IPv6	<p>This area of the page lets you select the following criteria:</p> <ul style="list-style-type: none"> • IPv6 Source Address—Adds IPv6 source IP • IPv6 Destination Address—Adds IPv6 destination IP • IPv6 Next Header—Adds IPv6 next header field. • IPv6 Source Port—Adds IPv6 source port • IPv6 Destination Port—Adds IPv6 destination port
Layer2	<p>This area of the page lets you select the following criteria:</p> <ul style="list-style-type: none"> • Source MAC Address—Adds L2 source MAC • Destination MAC Address—Adds L2 destination MAC • Ether Type—Adds L2 ethertype field.
MPLS	<p>This area of the page lets you select the following criteria:</p> <ul style="list-style-type: none"> • MPLS Hash—Adds MPLS labels (up to three)
GTP TEID	<p>This area of the page lets you select the following criteria:</p> <ul style="list-style-type: none"> • GTP TEID—Adds GTP tunnel endpoint identifier
Ingress Port	<p>This area of the page lets you select the following criteria:</p> <ul style="list-style-type: none"> • Ingress Ports—Adds ingress port

Advanced Hash Examples

The following are some different advanced hash examples. Note that the advanced hash method usually combines multiple criteria.

The example in [Figure 215: Advanced Hash with IPv4 Source and Destination Addresses](#) sets a **Custom** advanced hash method for slot 3 in box ID 5 that distributes traffic based on matching IPv4 source and destination addresses.

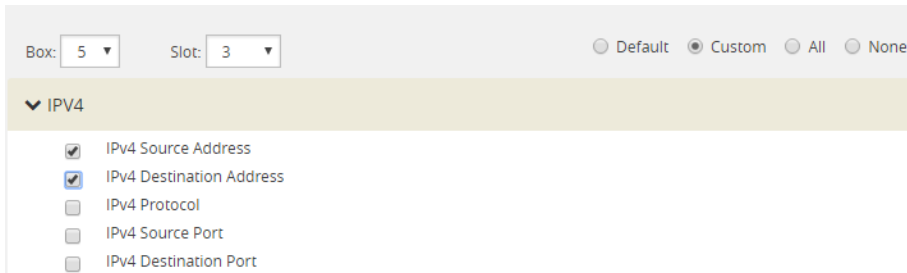


Figure 215: Advanced Hash with IPv4 Source and Destination Addresses

The example in [Figure 216: Advanced Hash Default Criteria](#) sets the advanced hash for slot cc1 in box ID 2 to the **Default** criteria.

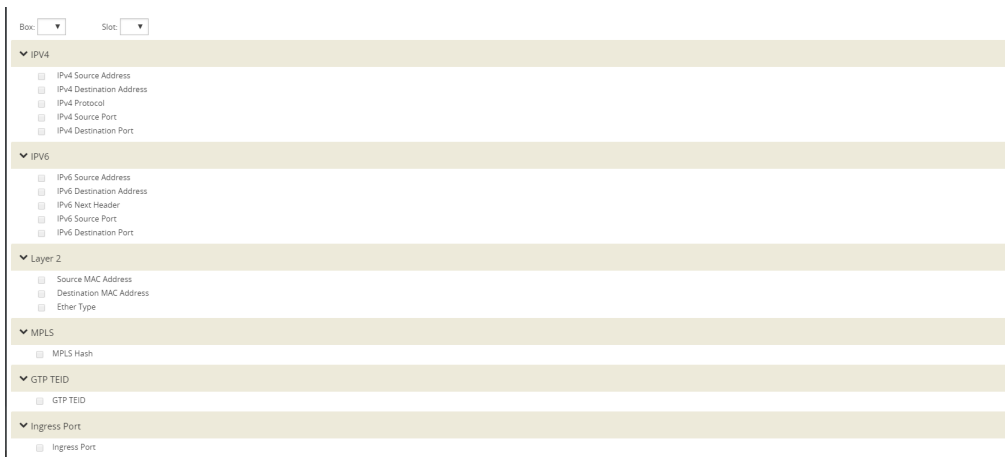


Figure 216: Advanced Hash Default Criteria

The example in [Figure 217: Advanced Hash with Source and Destination MAC Address](#) sets a **Custom** advanced hash for slot 5 in box ID 5 that distributes traffic based on matching source and destination MAC addresses.



Figure 217: Advanced Hash with Source and Destination MAC Address

Hashing Behavior

Table 33: Hashing Behavior Based on Hash Criteria Field Combinations shows the possible hash criteria field combinations and the corresponding hashing behavior based on packet type for advanced hashing for non-MPLS packets. (Refer to Table 34: Hashing Behavior Based on Hash Criteria Field Combinations for MPLS packets.)

Table 33: Hashing Behavior Based on Hash Criteria Field Combinations

Hash Criteria Fields	Packet Type	Hashing Behavior
Source MAC Address, Destination MAC Address	MAC	Hash on Source MAC Address, Destination MAC Address
Source MAC Address, Destination MAC Address	MAC + IPv4	Hash on Source MAC Address, Destination MAC Address
Source MAC Address, Destination MAC Address	MAC + IPv6	Hash on Source MAC Address, Destination MAC Address
IPv4 Source Address, IPv4 Destination Address	MAC	No hash
IPv4 Source Address, IPv4 Destination Address	MAC + IPv4	Hash on IPv4 Source Address, IPv4 Destination Address
IPv4 Source Address, IPv4 Destination Address	MAC + IPv6	No hash
IPv6 Source Address, IPv6 Destination Address	MAC	No hash
IPv6 Source Address, IPv6 Destination Address	MAC + IPv4	No hash
IPv6 Source Address, IPv6 Destination Address	MAC + IPv6	Hash on IPv6 Source Address, IPv6 Destination Address
Source MAC Address, Destination MAC	MAC	Hash on Source MAC Address, Destination

Hash Criteria Fields	Packet Type	Hashing Behavior
Address, IPv4 Source Address, IPv4 Destination Address		MAC Address
Source MAC Address, Destination MAC Address, IPv4 Source Address, IPv4 Destination Address	MAC + IPv4	Hash on IPv4 Source Address, IPv4 Destination Address
Source MAC Address, Destination MAC Address, IPv4 Source Address, IPv4 Destination Address	MAC + IPv6	Hash on Source MAC Address, Destination MAC Address
Source MAC Address, Destination MAC Address, IPv6 Source Address, IPv6 Destination Address	MAC	Hash on Source MAC Address, Destination MAC Address
Source MAC Address, Destination MAC Address, IPv6 Source Address, IPv6 Destination Address	MAC + IPv4	Hash on Source MAC Address, Destination MAC Address
Source MAC Address, Destination MAC Address, IPv6 Source Address, IPv6 Destination Address	MAC + IPv6	Hash on IPv6 Source Address, IPv6 Destination Address
Source MAC Address, Destination MAC Address, IPv4 Source Address, IPv4 Destination Address, IPv6 Source Address, IPv6 Destination Address	MAC	Hash on Source MAC Address, Destination MAC Address
Source MAC Address, Destination MAC Address, IPv4 Source Address, IPv4 Destination Address, IPv6 Source Address, IPv6 Destination Address	MAC + IPv4	Hash on IPv4 Source Address, IPv4 Destination Address
Source MAC Address, Destination MAC Address, IPv4 Source Address, IPv4 Destination Address, IPv6 Source Address, IPv6 Destination Address	MAC + IPv6	Hash on IPv6 Source Address, IPv6 Destination Address

NOTE: No hash means that the packets will be sent to the first port in the GigaStream.

Notes and Considerations for Advanced Hashing

Refer to the following notes and considerations for advanced hashing:

- With symmetric hashing, packets with their source and destination IP addresses and Layer 4 (L4) ports interchanged will go to the same GigaStream port. It is recommended to enable source and destination IPv4 or IPv6 pairs and L4 source and destination ports.
- On GigaVUE-HC3 nodes, symmetric hashing is enabled for all GigaStream.
- On GigaVUE-HC2 nodes, symmetric hashing is enabled for stack GigaStream.
- For stack GigaStream on GigaVUE-HC2 (with control card version 1 or 2) and GigaVUE-HC3, the following limitation applies:
 - For non-MPLS IPv4 and IPv6 packets, the hashing is fixed to the following 3-tuple: ipsrc, ipdst, and protocol or ip6src, ip6dst, and protocol.
 - All other traffic follows the advanced hash settings.
- ASICs used in Gigamon devices do not support hashing of the IP header fields when there is a PPPOE header. Only Layer 2 (L2) fields can be used for such packets.

Advanced Hashing with MPLS

Starting in software version 5.1, GigaStream MPLS hashing adds the ability to hash on MPLS labels as well as the following IP address fields inside an MPLS tunnel: **ipsrc**, **ipdst**, **ip6src**, and **ip6dst**.

Advanced hashing with MPLS is supported on all GigaVUE H Series and TA Series nodes, with the following distinctions:

- GigaVUE-HB1 is not supported.

Use the **Advanced Hash Settings** to specify MPLS, which can detect up to three MPLS labels. Packets with one to three MPLS labels can be hashed, along with IP address fields, if present. If a packet has more than three MPLS labels, IP address fields after the third MPLS label cannot be hashed. Refer to [Hashing Behavior Based on Hash Criteria Field Combinations](#) for details of the hashing behavior.

MPLS labels will be used as part of the GigaStream hash criteria if the MPLS field is configured and the packet has Ether Type 0x8847.

MPLS hashing applies to the following:

- regular GigaStream
- controlled GigaStream
- stack GigaStream

- inline tool groups

[Table 34: Hashing Behavior Based on Hash Criteria Field Combinations](#) shows the possible hash criteria field combinations and the corresponding hashing behavior based on packet type for advanced hashing with MPLS packets. (Refer to [Table 33: Hashing Behavior Based on Hash Criteria Field Combinations](#) for non-MPLS packets.)

Table 34: Hashing Behavior Based on Hash Criteria Field Combinations

Hash Criteria Fields	Packet Type	Hashing Behavior
IPv4 Source Address, IPv4 Destination Address	MAC + Label1 + Label2 + Label3 + IP + L4 + Payload	Hash on IP
Source MAC Address, Destination MAC Address	outer MAC + Label1 + Label2 + Label3 + inner MAC + IP + L4 + Payload	Hash on outer MAC
Source MAC Address, Destination MAC Address	MAC + Label1 + Label2 + Label3 + IP + L4 + Payload	Hash on MAC
MPLS Hash	MAC + Label1 + Label2 + Label3 + IP + L4 + Payload	Hash on MPLS Label1, Label2, Label3
MPLS Hash	MAC + Label1 + Label2 + IP + L4 + Payload	Hash on MPLS Label1, Label 2
MPLS Hash	MAC + Label1 + IP + L4 + Payload	Hash on MPLS Label1
MPLS Hash, Ether Type, IPv4 Protocol	MAC + Label1 + Label2 + Label3 + Label4 + IP + L4 + Payload	Hash on MPLS Label1, Label2, Label3
MPLS Hash, IPv4 Source Address, IPv4 Destination Address	MAC + MPLS Label1 + IP + L4 + Payload	Hash on MPLS Label1, IPv4 Source Address, IPv4 Destination Address
MPLS Hash, IPv4 Source Address, IPv4 Destination Address	MAC + Label1 + Label2 + IP + L4 + Payload	Hash on MPLS Label1, Label2, IPv4 Source Address, IPv4 Destination Address
MPLS Hash, IPv4 Source Address, IPv4 Destination Address	MAC + Label1 + Label2 + Label3 + IP + L4 + Payload	Hash on MPLS Label1, Label2, Label3, IPv4 Source Address, IPv4 Destination Address
MPLS Hash, IPv4 Source Address,	MAC + Label1 + Label2 + Label3 + Label4 + IP + L4 + Payload	Hash on MPLS Label1, Label2, Label3

Hash Criteria Fields	Packet Type	Hashing Behavior
IPv4 Destination Address		
MPLS Hash, IPv4 Source Address, IPv4 Destination Address	MAC + MPLS Label1 + MAC + IP + L4 + Payload	Hash on MPLS Label1
MPLS Hash, IPv4 Source Address, IPv4 Destination Address	MAC + Label1 + Label2 + MAC + IP + L4 + Payload	Hash on MPLS Label1, Label2
MPLS Hash, IPv4 Source Address, IPv4 Destination Address	MAC + Label1 + Label2 + Label3 + MAC + IP + L4 + Payload	Hash on MPLS Label1, Label2, Label3
MPLS Hash, Source MAC Address, Destination MAC Address	MAC + Label1 + Label2 + Label3 + IP + L4 + Payload	Hash on MPLS Label1, Label2, Label3
MPLS Hash, IPv4 Source Port, IPv4 Destination Port	MAC + Label1 + Label2 + Label3 + Label4 + IP + L4 + Payload	Hash on MPLS Label1, Label2, Label3
IPv4 Source Port, IPv4 Destination Port	MAC + Label1 + Label2 + Label3 + IP + L4 + Payload	No Hash

NOTES:

- No hash means that the packets will be sent to the first port in the GigaStream.
- If an MPLS packet has a router alert label as one of its labels, the router alert label is skipped and the other available labels are used for hashing. For example, if a packet has four labels and the second label is the router alert, the first, third, and fourth labels are used for hashing.

Advanced Hashing with GTP TEID

Starting in software version 5.2, GigaStream GTP TEID hashing adds the ability to hash on GTP tunnel endpoint identifiers (TEIDs). GPRS Tunneling Protocol (GTP) is an IP/UDP-based protocol for mobile data.

The TEID field in a GTP header is a unique identifier for mobile subscribers and is used to multiplex different connections on the same GTP tunnel. Use GTP TEID advanced hashing to load balance GTP packets across all GigaStream ports.

Advanced hashing with GTP TEID is supported on GigaVUE H Series and TA Series nodes, with the following distinctions:

- The following nodes are supported: GigaVUE-HC1, GigaVUE-HC2 (with control card version 1 or 2), GigaVUE-HC3, GigaVUE-TA40, and GigaVUE-TA100.
- The following nodes are not supported: GigaVUE-HB1, GigaVUE-TA1, and GigaVUE-TA10.

Use the **Advanced Hash Settings** to specify the **GTP TEID** field. It must be specified with one of the port source and destination pairs: either **IPv4 Source Port** and **IPv4 Destination Port** for IPv4 or **IPv6 Source Port** and **IPv6 Destination Port** for IPv6.

When the **GTP TEID** field is configured, GTP packets will use it for hashing along with configured IP fields, instead of the Layer 4 (L4) source and destination for GTP packets. The hashing for all non-GTP packets will be based on L4 source and destination port.

GTP TEID hashing is supported only for GTP-User packets, version 1 (V1), with L4 source and destination port 2152. The hashing functionality works only for non-fragmented packets.

Refer to [Hashing Behavior Based on Hash Criteria Fields: GTP TEID](#) for details of the hashing behavior.

GTP TEID hashing applies to the following:

- regular GigaStream
- controlled GigaStream
- stack GigaStream (except GigaVUE-HC2 and GigaVUE-HC3)
- inline tool groups

NOTE: GTP TEID hashing is not supported for stack GigaStream on GigaVUE-HC2 and GigaVUE-HC3 in this software version due to the 3-tuple limitation listed in [Notes and Considerations for Advanced Hashing](#).

[Table 35: Hashing Behavior Based on Hash Criteria Fields: GTP TEID](#) shows the possible hash criteria field combinations and the corresponding hashing behavior based on packet type for advanced hashing with GTP packets.

Table 35: Hashing Behavior Based on Hash Criteria Fields: GTP TEID

Hash Criteria Fields	Packet Type	Hashing Behavior
IPv4 Source Address, IPv4 Destination Address, IPv4 Source Port, IPv4 Destination Port	MAC + IP + L4 + Payload	Hash on IPv4 Source Address, IPv4 Destination Address, IPv4 Source Port, IPv4 Destination Port
IPv4 Source Address, IPv4 Destination Address, IPv4 Source Port, IPv4 Destination Port, GTP TEID	MAC + IP + L4 + GTP + Payload	Hash on IPv4 Source Address, IPv4 Destination Address, GTP TEID
IPv4 Source Address, IPv4 Destination Address, IPv4 Source Port, IPv4 Destination Port, GTP TEID	MAC + IP + L4 + Payload	Hash on IPv4 Source Address, IPv4 Destination Address, IPv4 Source Port, IPv4 Destination Port
IPv6 Source Address, IPv6 Destination Address, IPv6 Source Port, IPv6 Destination Port	MAC + IP + L4 + Payload	Hash on IPv6 Source Address, IPv6 Destination Address, IPv6 Source Port, IPv6 Destination Port
IPv6 Source Address, IPv6 Destination Address, IPv6 Source Port, IPv6 Destination Port, GTP TEID	MAC + IP + L4 + GTP + Payload	Hash on IPv6 Source Address, IPv6 Destination Address, GTP TEID
IPv6 Source Address, IPv6 Destination Address, IPv6 Source Port, IPv6 Destination Port, GTP TEID	MAC + IP + L4 + Payload	Hash on IPv6 Source Address, IPv6 Destination Address, IPv6 Source Port, IPv6 Destination Port

Packet Distribution and the Advanced Hash Algorithm

- When an **IPv4 Fragmentation** map rule is used to send traffic to an advanced hash tool GigaStream, all fragments are consolidated to a single port within the GigaStream.
- Packets with multiple VLAN tags (such as Q-in-Q) will experience uneven traffic distribution. For this traffic, GigaSMART load balancing is recommended.

Weighted GigaStream

Weighted GigaStream provides you the ability to distribute traffic to the ports by assigning either an equal weight or a custom weight to the ports. You can assign custom weight in percentage or ratio.

If a port in a weighted GigaStream goes down, the traffic from the port will be redistributed to other healthy ports in the weighted GigaStream. The port assigned with maximum weight receives more traffic than the ports assigned with lesser weight.

Weighted GigaStream is supported on the following:

- All GigaVUE-HC Series and GigaVUE-TA Series nodes.
- Regular tool GigaStream, regular hybrid GigaStream, and regular circuit GigaStream.

Use the **Weighting** and **Drop Weight** fields in the GigaStream configuration page to configure a weighted GigaStream. For instructions, refer to [Configure Regular GigaStream](#).

You can also choose to rehash the traffic when you find that the traffic distribution is not ideal. When you rehash the traffic, GigaVUE-FM reassigns the hash buckets to the ports. For example, the following table shows that the ports are assigned with sequential hash buckets:

Port	Hash Buckets
x1	1, 2, 3, 4
x3	5, 6, 7, 8
x4	9, 10, 11, 12

In such cases, the traffic distribution may not be ideal. You can choose to rehash the traffic. The following table shows how the hash buckets are reassigned when you rehash the traffic:

Port	Hash Buckets
x1	1, 4, 7, 10
x3	2, 5, 8, 11
x4	3, 6, 9, 12

GigaStream Rules and Maximums

The following rules apply to regular GigaStream and controlled GigaStream:

GigaStream Rule	Description
Port Location	All participating ports must be on the same GigaVUE node. On the GigaVUE-HC2 and GigaVUE-HC3, GigaStream can be across modules.

GigaStream Rule	Description
Speed Requirements	<ul style="list-style-type: none"> • All participating ports must be running the same speed (1Gb, 10Gb, 40Gb. or 100Gb) and must use the same port types (for example, all g, x, q, or c). • A stack GigaStream must consist of ports with 10Gb speed or higher. • The system will not let you change the speed of any port participating in a tool GigaStream. Keep in mind that the only ports that allow speed changes through are gx ports. • You can use gx ports in a regular tool GigaStream, but only with ports running at the same speed (and no slower than 1000Mb).
Addressing	Once a port belongs to a GigaStream, it must be addressed by its GigaStream alias. It can no longer be addressed as an individual port. For example, if tool port 1/1/x4 is part of a tool GigaStream, the GigaVUE H Series node prevents you from using it as the destination for a map rule.
Stack Ports	Stacking ports must be 10Gb or higher. Therefore, the Maximum Stack Ports per GigaStream for any 1Gb port is N/A in GigaVUE-HC3: Maximum Ports per GigaStream to GigaVUE-TA200: Maximum Ports per GigaStream
SFP+	For SFP+ ports that can operate at 10Gb or 1Gb, refer to the values in the Maximum Tool Ports per GigaStream column for the 10Gb Ports rows in GigaVUE-HC3: Maximum Ports per GigaStream to GigaVUE-TA200: Maximum Ports per GigaStream .

For GigaStream maximums, refer to [Maximum Ports per GigaStream](#), which have been updated in software version 5.1.

Maximum Ports per GigaStream

[Table 36: GigaVUE-HC3: Maximum Ports per GigaStream](#) to [Table 44: GigaVUE-TA200: Maximum Ports per GigaStream](#) list the maximum ports per GigaStream for GigaVUE nodes.

Table 36: GigaVUE-HC3: Maximum Ports per GigaStream

GigaVUE-HC3	Ports Allowed	Maximum Tool Ports per GigaStream	Maximum Stack Ports per GigaStream
100Gb Ports			
PRT-HC3-C08Q08 (QSFP28)	c1..c8	8	8
PRT-HC3-C16 (QSFP28) * Must be equipped with CCv2	c1..c16	16	16

GigaVUE-HC3	Ports Allowed	Maximum Tool Ports per GigaStream	Maximum Stack Ports per GigaStream
SMT-HC3-C05 (QSFP28)	c1..c5	5	5
40Gb Ports			
PRT-HC3-C08Q08 (QSFP+)	c1..c8	8	8
PRT-HC3-C08Q08 (QSFP+) (2x40G mode)	c1q1..c1q2 to c8q1..c8q2	16	N/A
PRT-HC3-C16 (QSFP+) * Must be equipped with CCv2	c1..c16	16	16
SMT-HC3-C05 (QSFP+)	c1..c5	5	5
25Gb Ports * Must be equipped with Control Card version 2 (CCv2)			
PRT-HC3-X24 (SFP28)	x1..x24	24	N/A
PRT-HC3-C08Q08 (QSFP28) (4x25G mode)	c1x1..c1x4 to c8x1..c8x4	8	N/A
PRT-HC3-C16 (QSFP28) (4x25G mode)	c1x1..c1x4 to c15x1..c15x4 odd-numbered ports only	32	N/A
SMT-HC3-C05 (QSFP28) (4x25G mode)	c1x1..c1x4 to c5x1..c5x4	20	N/A
BPS-HC3-C25F2G (SFP28)	x1..x16	16	N/A
10Gb Ports			
PRT-HC3-X24 (SFP+)	x1..x24	24	N/A
PRT-HC3-C08Q08 (QSFP+) (4x10G mode)	c1x1..c1x4 to c8x1..c8x4	32	32
PRT-HC3-C16 (QSFP+) (4x10G mode) (8 ports)	c1x1..c1x4 to c15x1..c15x4 odd-numbered ports only	32	N/A
SMT-HC3-C05 (QSFP+) (4x10G mode)	c1x1..c1x4 to c5x1..c5x4	20	N/A
BPS-HC3-C25F2G (SFP+)	x1..x16	16	N/A
BPS-HC3-C25F2G (4x10G mode)	c1x1..c1x4 to c4x1..c4x4	16	N/A

NOTE: GigaStream can be created across GigaVUE-HC3 modules. For example, with four PRT-HC3-C08Q08 modules in **4x10G** mode, the maximum tool ports per GigaStream on a GigaVUE-HC3 is $8 \times 4 \times 4 = 128$, or with three PRT-HC3-X24 modules and one PRT-HC3-C08Q08 module in **4x10G** mode, the maximum tool ports per GigaStream on a GigaVUE-HC3 is $(24 \times 3) + (8 \times 4) = 104$.

You can also create stack GigaStream across GigaVUE-HC3 modules. The maximum number of ports in a stack GigaStream across the GigaVUE-HC3 node is 32.

Table 37: GigaVUE-HC2 Modules: Maximum Ports per GigaStream

GigaVUE-HC2 Module	Ports Allowed	Maximum Tool Ports per GigaStream	Maximum Stack Ports per GigaStream
100Gb Ports			
PRT-HC0-C02	c1..c2	2	N/A
40Gb Ports			
PRT-HC0-Q06	q1..q6	6	6
10Gb Ports			
PRT-HC0-X24	x1..x24	24	24
BPS-HC0-D25A4G BPS-HC0-D25B4G BPS-HC0-D35C4G	x1..x16	16	16
BPS-HC0-Q25A28	x1..x8	8	8
SMT-HC0-X16	x1..x16	16	16

NOTE: GigaStream can be created across GigaVUE-HC2 modules. For example, with four PRT-HC0-X24 modules, the maximum tool ports per GigaStream on a GigaVUE-HC2 is $24 \times 4 = 96$.

You can also create stack GigaStream across GigaVUE-HC2 modules. The maximum number of ports in a stack GigaStream across the GigaVUE-HC2 node is 48.

Table 38: GigaVUE-HC1: Maximum Ports per GigaStream

GigaVUE-HC1	Ports Allowed	Maximum Tool Ports per GigaStream	Maximum Stack Ports per GigaStream
10Gb Ports			
GigaVUE-HC1 base chassis	x1..x12	12	12
TAP-HC1-G10040	N/A	N/A	N/A
1Gb Ports			
GigaVUE-HC1 base chassis	g1..g4	4	N/A
BPS-HC1-D25A24	x1..x4	4	4

Table 39: GigaVUE-HB1: Maximum Ports per GigaStream

GigaVUE-HB1	Ports Allowed	Maximum Tool Ports per GigaStream	Maximum Stack Ports per GigaStream
10Gb Ports			
GigaVUE-HB1	x1..x4	4	4
1Gb Ports			
GigaVUE-HB1	g1..g16	8	N/A

Table 40: GigaVUE-TA1/GigaVUE-TA10/GigaVUE-OS on a White Box: Maximum Ports per GigaStream

GigaVUE TA Series	Ports Allowed	Maximum Tool Ports per GigaStream	Maximum Stack ports per GigaStream
40Gb Ports			
GigaVUE-TA1/GigaVUE-TA10/GigaVUE-OS on a white box (48x mode)	q1..q4	4	4
GigaVUE-TA1/GigaVUE-TA10/GigaVUE-OS on a white box (56x mode)	q3..q4	2	2
GigaVUE-TA1/GigaVUE-TA10/GigaVUE-OS on a white box (64x mode)	N/A	N/A	N/A

GigaVUE TA Series	Ports Allowed	Maximum Tool Ports per GigaStream	Maximum Stack ports per GigaStream
10Gb Ports			
GigaVUE-TA1/GigaVUE-TA10/GigaVUE-OS on a white box (48x mode)	x1..x48	48	32
GigaVUE-TA1/GigaVUE-TA10/GigaVUE-OS on a white box (56x mode)	x1..x56	56	32
GigaVUE-TA1/GigaVUE-TA10/GigaVUE-OS on a white box (64x mode)	x1..x64	64	32

Table 41: GigaVUE-TA40: Maximum Ports per GigaStream

GigaVUE-TA40	Ports Allowed	Maximum Tool Ports per GigaStream	Maximum Stack Ports per GigaStream
40Gb Ports			
GigaVUE-TA40 (0x mode)	q1..q32	32	32
GigaVUE-TA40 (16x mode)	q5..q32	28	28
10Gb Ports			
GigaVUE-TA40 (0x mode)	N/A	N/A	N/A
GigaVUE-TA40 (16x mode)	x1..x16	16	N/A

Table 42: GigaVUE-TA100: Maximum Ports per GigaStream

GigaVUE-TA100	Ports Allowed	Maximum Tool Ports per GigaStream	Maximum Stack Ports per GigaStream
100Gb Ports			
GigaVUE-TA100 (QSFP28) (16 ports)	c1..c16	16	16
GigaVUE-TA100 (QSFP28)	c1..c24	24	24

GigaVUE-TA100	Ports Allowed	Maximum Tool Ports per GigaStream	Maximum Stack Ports per GigaStream
(24 ports)			
GigaVUE-TA100 (QSFP28) (32 ports)	c1..c32	32	32
40Gb Ports			
GigaVUE-TA100 (QSFP+) (16 ports)	c1..c16	16	16
GigaVUE-TA100 (QSFP+) (24 ports)	c1..c24	24	24
GigaVUE-TA100 (QSFP+) (32 ports)	c1..c32	32	32
10Gb Ports			
GigaVUE-TA100 (QSFP+) (4x10G mode) (16 ports)	c1x1..c1x4 to c16x1..c16x4	64	64
GigaVUE-TA100 (QSFP+) (4x10G mode) (24 ports)	c1x1,,c1x4 to c24x1..c24x4	96	64
GigaVUE-TA100 (QSFP+) (4x10G mode) (32 ports)	c1x1..c1x4 to c32x1..c32x4	128	64

Table 43: GigaVUE-TA100-CXP: Maximum Ports per GigaStream

GigaVUE-TA100-CXP	Ports Allowed	Maximum Tool Ports per GigaStream	Maximum Stack Ports per GigaStream
100Gb Ports			
GigaVUE-TA100-CXP (CXP ports) (20 ports)	c1..c20	20	N/A
GigaVUE-TA100-CXP (QSFP28 ports) (8 ports)	c21..c28	8	N/A

GigaVUE-TA100-CXP	Ports Allowed	Maximum Tool Ports per GigaStream	Maximum Stack Ports per GigaStream
40Gb Ports			
GigaVUE-TA100-CXP (QSFP28 ports) (8 ports)	c21..c28	8	N/A
10Gb Ports			
GigaVUE-TA100-CXP (QSFP+) (4x10G mode) (8 ports)	c21x1..c21x4 to c28x1..c28x4	32	N/A

Table 44: GigaVUE-TA200: Maximum Ports per GigaStream

GigaVUE-TA200	Ports Allowed	Maximum Tool Ports per GigaStream	Maximum Stack Ports per GigaStream
100Gb Ports			
GigaVUE-TA200 (QSFP28)	c1..c64	64	16
25Gb Ports			
GigaVUE-TA200 (QSFP28) (4x25G mode) (32 ports)	c1x1..c1x4 to c10x1..c10x4 and c23x1..c23x4 to c32x1..c32x4	80	N/A
GigaVUE-TA200 (QSFP28) (4x25G mode) (64 ports)	c33..c64	N/A	N/A
10Gb Ports			
GigaVUE-TA200 (QSFP+) (4x10G mode) (32 ports)	with no restrictions: c1x1..c1x4 to c10x1..c10x4 and c23x1..c23x4 to c32x1..c32x4 with restrictions: c11x1..c11x4 to c22x1..c22x4	128	N/A

Port Statistics and Counters

This section describes the counters displayed for the Port Statistics information. This page provides information similar to the output from the **show port stats** command from the CLI.

The major sections in This section include:

- [Display Port Statistics](#)
- [How to Reset Traffic Counters](#)

Display Port Statistics

From the **Ports** page, you can view the port statistics for either of the following:

- A single port or view. For details, refer to [Display Port Statistics for a Single Port](#)
- All the ports. For details refer to [Display Statistics for All Ports](#)

Display Port Statistics for a Single Port

From the **Ports > Ports > All Ports**, select any port by clicking on the row. The quick view window that appears provides port statistics for that particular port. Each field is color-coded in the graphical representation.

By hovering over the graph, numerical value for each of the data points is visible as shown in [Figure 218: Numerical Values for Data Points on the Statistics Graph](#).

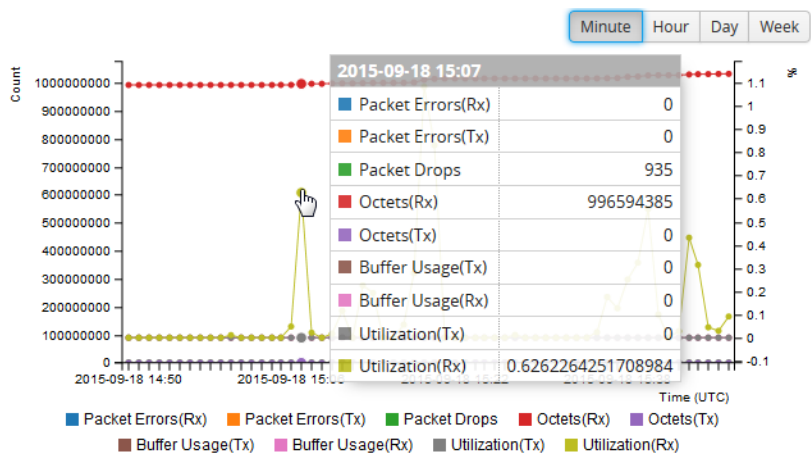


Figure 218: Numerical Values for Data Points on the Statistics Graph

You can modify the time lapse for measuring various data points by selecting the Minutes, Hour, Day, or Week button. Figure 219: Numerical Values for the Data Points Measured by Hour shows the data points measured by hour.

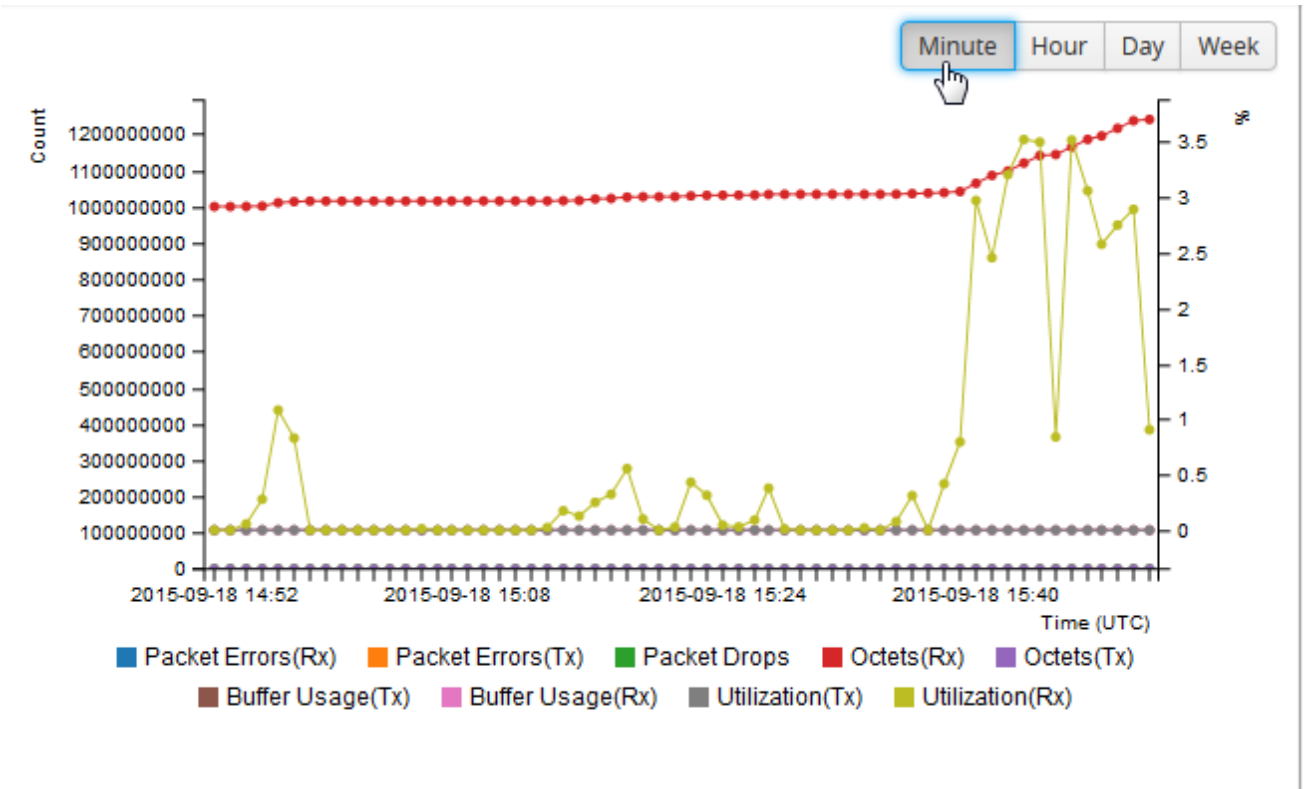


Figure 219: Numerical Values for the Data Points Measured by Hour

Table 45: Port Statistics Definitions describes the port statistics available.

Table 45: Port Statistics Definitions

Count er	Definition	Notes
Packet Errors	Total Error Packets Received or Transmitted This indicates hardware detected errors. Error packets include undersize, FCS/CRC, MTU exceeded, fragments, and oversize packets.	Excludes oversize packets without FCS/CRC. Packets larger than the MTU setting arriving on a network port are counted twice in the counter. So 1000 oversize packets would show up as 2000. This double-counting only happens with Oversize error packets.
Discards	Discards Received or Transmitted	Discards are counted in the following cases: <ul style="list-style-type: none"> Traffic arriving at a network port that is not logically connected using a map or map passall.

Count er	Definition	Notes
		<ul style="list-style-type: none"> • Map rules/map rules applied on a network port. • In packets on a tool port. • Pause frames.
Packet Drops	Total Dropped Packets Received or Transmitted	Packets are dropped when a port's bandwidth is exceeded due to oversubscription. Packets are dropped when they reach the port but before they are sent out.
Octets	Total Bytes Received or Transmitted Includes all valid and error frames with the exceptions noted in the adjacent columns.	Excludes undersize frames.
Buffer Usage	Percentage of buffer space used by packets transmitted or received	The buffer is used when the port reaches 100 percent utilization during a microburst. If the buffer reaches 100 percent utilization, packets may be dropped.
Utilization	Percentage of port utilization by packets received or transmitted	
Packets	Total Packets Received or Transmitted Excludes multicast packets, broadcast packets, packets with FCS/CRC errors, MTU exceeded errors, oversize packets, and pause packets.	Excludes packets with FCS/CRC errors.

Display Statistics for All Ports

To view the statistics for all ports select, **Ports > Ports > Statistics**. The **Ports Statistics** page displays, which shows a table with the statistics for each port as shown in [Figure 220: Port Statistics for All Ports](#). For the definitions of the statistics shown in the table, refer to [Table 45: Port Statistics Definitions](#).

Port ID	Octets		Octets /sec		Unicast Packets		Non-Unicast Packets		Packets /sec		Packet Drops		Discards		Error		Utilization	
	Rx	Tx	Rx	Tx	Rx	Tx	Rx	Tx	Rx	Tx	Rx	Tx	Rx	Tx	Rx	Tx	Rx	Tx
1/1/x20	0	0	0	0	0	0	0	0	0	0	0	0	0	0	0	0	0	0
vTunnelEn...	2.38 G	83.03 K	36.42 K	0	2.26 M	1.18 K	310.9 K	0	49	0	0	0	0	0	0	0	0.03	0
toRSASecu...	290.98 K	0	0	0	0	0	1.42 K	0	0	0	0	0	1.42 K	0	0	0	0	0
vTunnelEn...	2.38 G	0	36.42 K	0	2.26 M	0	310.89 K	0	49	0	0	0	2.57 M	0	0	0	0.03	0
Demo_To...	0	0	0	0	0	0	0	0	0	0	0	0	0	0	0	0	0	0
1/2/q1	0	0	0	0	0	0	0	0	0	0	0	0	0	0	0	0	-	-
1/2/q2	0	0	0	0	0	0	0	0	0	0	0	0	0	0	0	0	-	-
1/2/q3	0	0	0	0	0	0	0	0	0	0	0	0	0	0	0	0	-	-
1/2/q4	0	0	0	0	0	0	0	0	0	0	0	0	0	0	0	0	-	-
1/2/q5	0	0	0	0	0	0	0	0	0	0	0	0	0	0	0	0	-	-

Figure 220: Port Statistics for All Ports

The information on the statistics page can be filtered as well as downloaded to an Excel spreadsheet. To export the statistics, click **Export**. The statics table is downloaded with a filename in the format Port_Stats_<yyyymmddhhmmss>; for example, Port_Stats_20161003172336.

To filter the port statistics, click **Filter**. A Filter Quick View opens, where you can specify how to filter ports displayed on the Statistics page.

The criteria that you can use to filter the port statistics is as follows:

Criteria	Description
Box/Slot ID	Display only those ports that match the specified box and slot IDs.
Port Alias	Display port with the specified alias.
Port ID	Display ports with specified number in the port ID. For example, if you specify 3 the result will also display ports that include the number 3, 13, 23, 30, and so on.
Type	Display ports with the specified port type. Select one of the following: <ul style="list-style-type: none"> • Network • Tool • Inline Network • Inline Tool

Criteria	Description
	<ul style="list-style-type: none"> • GigaSMART • Hybrid • Stack
Admin Status	<p>Display ports based on their current admin status. The possible selections are:</p> <ul style="list-style-type: none"> • All — display ports with a status of Enabled or Disabled. This is the default. • Enabled — display ports with admin enabled • Disabled — display ports with admin disabled
Link Status	<p>Display ports based on their current link status: The possible selections are:</p> <ul style="list-style-type: none"> • All — display ports with a status of Up or Down. This is the default. • Enabled — display ports with a link status of up. • Disabled — display ports with a link status of down.

How to Reset Traffic Counters

To reset the traffic counters, do the following:

1. Select a port on the All Ports page. The Quick View page opens for the port.
2. On the Quick View page, click **Edit**.
3. On the ports page, click **Reset Traffic Counters**.

Monitor Port Utilization

This section describes how to monitor port utilization and buffer thresholds on the GigaVUE H Series and GigaVUE TA Series nodes. Refer to the following sections for details:

- [Port Utilization Availability by Port Type](#)
- [Set Port Utilization Thresholds](#)
- [Configure Alarm Buffer Thresholds](#)
- [Set Alarm Buffer Thresholds](#)

Port Utilization Availability by Port Type

You can view port utilization for all network, tool, hybrid, and stack link ports on the GigaVUE H Series or GigaVUE TA Series node by selecting **Ports > All Ports** and looking at the Utilization (Tx/Rx) column in the table as shown in [Figure 221: Port Utilization](#).

<input type="checkbox"/>	↑ Port Id	Alias	Type	Speed	Admin Enabled	Link Status	Transceiver Type	Utilization (Tx/Rx)	Port Filter	Discovery Protocol
<input type="checkbox"/>	1/1/x1		IT		–	down		0 / 0	–	Off
<input type="checkbox"/>	1/1/x2		IT		–	down		0 / 0	–	Off
<input type="checkbox"/>	1/1/x3		IT		–	down		0 / 0	–	Off
<input type="checkbox"/>	1/1/x4		IT		–	down		0 / 0	–	Off
<input type="checkbox"/>	1/1/x5		IN		–	down		0 / 0	–	Off
<input type="checkbox"/>	1/1/x6		IN		–	down		0 / 0	–	Off
<input type="checkbox"/>	1/1/x7	rbac1	N		–	down		0 / 0	–	Off
<input type="checkbox"/>	1/1/x8	fire-eye	T		–	down		0 / 0	–	Off
<input type="checkbox"/>	1/1/x9		S		–	down	sfp+ sr	0 / 0	–	Off

Figure 221: Port Utilization

The utilization is the utilization for all requested ports with the port number, port type, port speed, receive (Rx) utilization percentage (network and stack ports), transmit (Tx) utilization percentage (tool, hybrid, and stack ports), alarm threshold, and the last time the threshold was exceeded on either the transmit or receive channel.

Set Port Utilization Thresholds

To set the Alarms for port utilization, do the following:

1. Select **Ports > Ports > All Ports**.
2. Select Port ID of the port on which you want to set the utilization threshold.
3. Click **Edit** to open the port editor.

- Under **Alarms**, in the **Utilization Threshold** field, enter the percentage at which the GigaVUE H Series node logs an alarm for the port. By default, the thresholds are 0, which means disabled.

NOTE: Network ports always use an Rx threshold. Tool ports always use Tx. Stack ports and hybrid ports use both Rx and Tx, and the same threshold is used for each.

The screenshot displays the configuration page for a port. At the top, there is an 'Alias' field. Below it, the 'Parameters' section is expanded, showing the following settings:

- Admin:** Enable
- Type:** Tool (dropdown menu)
- Speed:** 10G (dropdown menu)
- Duplex:** Full, Half
- Auto Negotiation:** Enable
- Force Link Up:** Enable
- Timestamp:** Append Ingress, Strip Egress, Source ID Egress (with a value of 1-65535)

Below the parameters, the 'Alarms' section is expanded, showing the following configuration:

Buffer Threshold (%)	Rx	50	Tx	50
Utilization Threshold (%)		85		

Utilization Alarm/SNMP Trap Generation

The GigaVUE H Series or GigaVUE TA Series node generates a utilization alarm each time the configured threshold is exceeded for more than six consecutive seconds. Once the percentage utilization falls below the configured threshold for at least six consecutive seconds, a second alarm is generated to indicate that utilization has returned to normal. Once utilization has returned to normal (six consecutive seconds below the threshold), a new utilization alarm can be generated once the measured rate again remains above the threshold for six consecutive seconds.

Utilization alarms are written to syslog and forwarded to all SNMP management stations configured as notification destinations. For SNMP traps to be generated, forwarded, and displayed correctly in your SNMP management station, all of the following must be true:

Configure Alarm Buffer Thresholds

Often network ports are utilized at rates below 50%. If several network ports are aggregated, there is a risk of oversubscribing the tool ports. Alarm buffer thresholds are used to monitor the congestion within the GigaVUE node caused by microbursts or by oversubscription of tool ports.

The buffer usage on any port remains at zero until the maximum line rate of the port is reached. When the usage crosses 100% either instantaneously, in the microburst case, or prolonged, in the oversubscription case, there is congestion.

The internal buffer on the GigaVUE node can absorb a certain number of packet bursts. During congestion, packets are buffered in the chassis and the buffer usage is reported on the corresponding ports and in the corresponding direction: rx (ingress) and tx (egress).

Reporting the buffer usage provides a trend of how the microbursts are causing congestion, so more tool ports can be added before packets are dropped. Buffer usage is measured in intervals of 5 seconds. The peak buffer usage within a 5-second interval is reported.

When buffer usage is less than or equal to zero, there is no congestion, so no packets are dropped due to buffer unavailability.

When buffer usage is greater than zero, there is congestion. When buffer usage is greater than zero on any port in any direction, there is a chance that the packets (that caused the buffer usage to increase) are dropped due to unavailable buffers. However, it is unlikely to see packet drops due to buffer unavailability when the buffer usage on a port is less than 5%.

The buffer usage feature is supported on all ports and module types on the GigaVUE-HC3 and GigaVUE-HC2 (equipped with Control Card version 1 only).

Refer to [Set Alarm Buffer Thresholds](#) for configuring buffer thresholds and for configuring a notification that can be sent when a threshold is exceeded.

Set Alarm Buffer Thresholds

Use the Alarms section of the Ports configuration page to set rx (ingress) and tx (egress) alarm buffer threshold on a port and utilization threshold. You can specify the alarm buffer threshold in the rx and tx directions on network and stack type ports and in the tx direction on tool type ports. By default, the threshold is set to 0, which disables the threshold.

When a buffer usage threshold has exceeded its configured percentage, a message is logged, and optionally, an SNMP trap is sent to all configured destinations.

The SNMP trap will be sent when a threshold is exceeded in any 5-second interval. Once the trap is sent, there is a 30 second hold-off time before the trap is sent again.

For information about how to set SNMP traps, refer to the *"Using SNMP"* section in the *GigaVUE-OS and GigaVUE-FM Administration Guide*.

To set the alarm buffer threshold and the usage thresholds on a port do the following:

1. Select **Ports > Ports > All Ports**.
2. Select the Port on the Ports page.
3. In the Alarms section of the Port configuration page, enter the **Rx** and **Tx** values for the **Buffer Threshold** and the **High** and **Low Values** for the **Utilization Threshold**. [Figure 222: Alarm Buffer Thresholds Set](#) shows an example.
4. Click **Save**.

The screenshot shows a configuration page for a port. It is divided into two main sections: 'Parameters' and 'Alarms'.

Parameters:

- Admin:** Enable
- Type:** Tool
- Speed:** 10G
- Duplex:** Full Half
- Auto Negotiation:** Enable
- Force Link Up:** Enable
- Timestamp:** Append Ingress, Strip Egress, Source ID Egress (1-65535)

Alarms:

- Buffer Threshold (%):** Rx 50, Tx 50
- Utilization Threshold (%):** 85

Figure 222: Alarm Buffer Thresholds Set

Header Stripping

With the header stripping functionality enabled on the network and hybrid ports, the GigaVUE devices can identify and remove headers from tagged packets or tunneled (encapsulated) packets. Refer to the following sections for details:

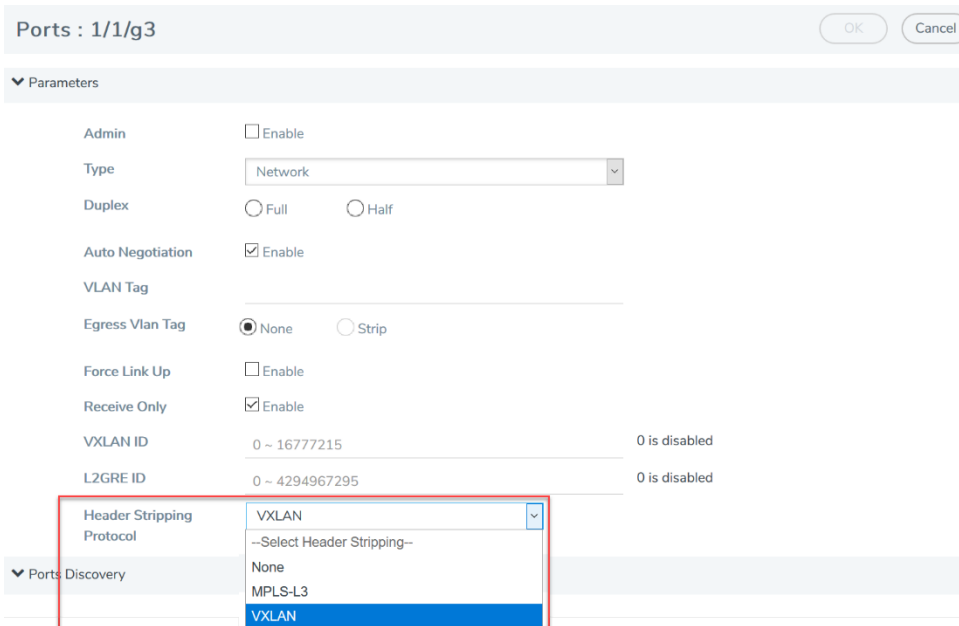
- About VXLAN Header Stripping
- About MPLS Header Stripping

Enable Header Stripping Protocol on Ports

You can enable header stripping protocol on any network or hybrid ports. If you enable the header stripping protocol on a port, you cannot configure the VXLAN ID or L2GRE ID for that port.

To enable a header stripping protocol on a network or hybrid port:

1. From the device view, go to **Ports > Ports > All Ports**.
2. Select the required network or hybrid port on which you want to enable the header stripping protocol, and then click **Edit**.
3. Under the Parameters section, from the **Header Stripping Protocol** drop-down list, select one of the following options:
 - **None** – Header stripping protocol is not enabled on the port.
 - **MPLS-L3** – Port is enabled with MPLS header stripping protocol to strip the MPLS header from the MPLS layer 3 packets that are tapped on this port.
 - **VXLAN** – Port is enabled with VXLAN header stripping protocol to strip the VXLAN header from the VXLAN packets that are tapped on this port.
4. Click **OK** to save the configuration.



Tunnels

Tunneling is a communication protocol that is used to transmit data from one network to another by encapsulating the data. A tunnel is a virtual interface. You can create tunnels for both encapsulation and decapsulation.

Required License: Advanced Feature License on GigaVUE TA Series Nodes

This chapter describes about the different types of native tunnels, which are independent of GigaSMART operations. It also describes how to configure these tunnels for encapsulating and decapsulating traffic. Refer to the following sections for details:

- [About Circuit-ID Tunnels](#)
- [About Layer 2 Generic Routing Encapsulation \(L2GRE\) Tunnels](#)
- [About Virtual Extensible LAN \(VXLAN\) Tunnels](#)
- [Create Tunnel](#)
- [Create VXLAN / L2GRE Group](#)
- [Configure L2GRE / VXLAN Identifier](#)
- [View VXLAN / L2GRE ID Statistics](#)

About Circuit-ID Tunnels

Circuit-ID tunnels are used to route traffic between two clusters. The traffic is tapped and sent through network ports that are configured on the cluster in the encapsulation side. Based on the flow map configuration, traffic is filtered and then sent through the circuit ports that are configured as the destination port in the map. These circuit ports encapsulate the traffic with a circuit-ID and transmit the encapsulated traffic through the circuit tunnel that connects two clusters. At the receiving end of another cluster in the decapsulation side, the circuit port that is configured as the source port decapsulates the traffic and sends the traffic to the appropriate tools through the tool ports.

Figure 223: Circuit Flow Mapping® illustrates the circuit flow mapping between two clusters using circuit-ID.

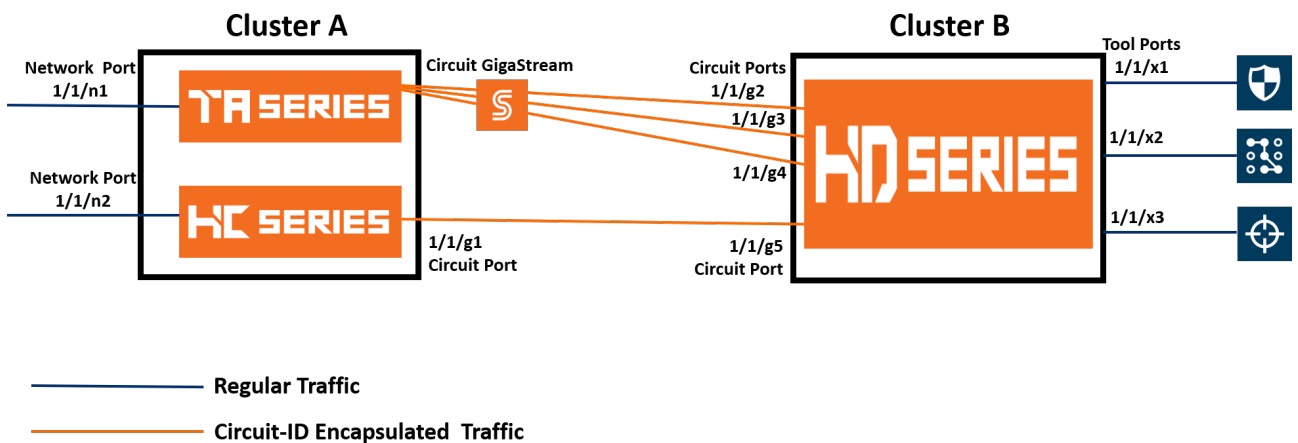


Figure 223: Circuit Flow Mapping®

In this example, the GigaVUE-TA Series and GigaVUE-HC Series nodes reside in cluster A. The tapped traffic is sent through network ports, 1/1/n1 and 1/1/n2. Based on the rules configured in the map, the traffic is filtered at the nodes in cluster A. The filtered traffic is then sent through the circuit port, 1/1/g1 and circuit GigaStream that are configured as the destination port in the map. These circuit ports encapsulate the traffic with circuit-ID and transmit the encapsulated traffic through the circuit tunnel that connects cluster A and cluster B. At the receiving end of cluster B, the circuit ports, 1/1/g2, 1/1/g3, 1/1/g4, and 1/1/g5 that are configured as the source ports decapsulate the traffic, strip the circuit-ID, and send the traffic to the appropriate tools through the tool ports, 1/1/x1, 1/1/x2, and 1/1/x3.

Refer to the following sections for details about the Circuit-ID tunnel encapsulation and decapsulation:

- [Circuit-ID Tunnels—Rules and Notes](#)
- [Circuit-ID Tunnel Encapsulation](#)
- [Circuit-ID Tunnel Decapsulation](#)

Circuit-ID Tunnels—Rules and Notes

Keep in mind the following rules and notes when working with Circuit-ID tunnel encapsulation and decapsulation:

- A maximum of 512 circuit-IDs are supported within a cluster for encapsulation and decapsulation.
- If a network port receives a double-tagged packet that is encapsulated with a circuit-ID, the five tuple hashing will not work only in the second cluster, that is the cluster in the decapsulation side over stack GigaStream or tool gigastream. Hence, traffic cannot be filtered using the IP/L4 parameters. After decapsulation, flow mapping filters the traffic based on circuit-ID.
- It is not supported for inline scenarios.

Keep in mind the following rules and notes when working with Circuit-ID tunnel encapsulation:

- Circuit-ID tunnel encapsulation is not supported on Pass All maps.
- Port filter configured on circuit port for VLAN pass/drop will try to match the encap circuit-id instead of packet outer VLAN.

Keep in mind the following rules and notes when working with Circuit-ID tunnel decapsulation:

- A maximum of 512 circuit-ID tunnels can be created for decapsulation.
- Circuit-ID tunnel decapsulation is not supported on Pass All and Shared Collector maps.
- A circuit-ID must be paired with a circuit port, only in one circuit-ID tunnel.

Circuit-ID Tunnel Encapsulation

Before creating a Circuit-ID tunnel for encapsulation, refer to the [Circuit-ID Tunnels—Rules and Notes](#).

The following table summarizes the required tasks to configure a circuit-ID tunnel for encapsulating the traffic:

S.N o	Task	Refer to...
1.	Configure the required circuit ports and circuit GigaStream.	<ul style="list-style-type: none"> • Configure Ports • Configure Regular GigaStream
2.	Configure a circuit-ID tunnel for encapsulation. Ensure that you select the mode as Encap .	Create Tunnel
3.	Configure a map to encapsulate the traffic and attach the circuit-ID tunnel to the map.	Create a New Map

Circuit-ID Tunnel Decapsulation

Before creating a Circuit-ID tunnel for encapsulation, refer to the [Circuit-ID Tunnels—Rules and Notes](#).

The following table summarizes the required tasks to configure a circuit-ID tunnel for decapsulating the traffic:

S.N o	Task	Refer to...
1.	Configure the required circuit ports and circuit GigaStream.	<ul style="list-style-type: none"> • Configure Ports • Configure Regular GigaStream
2.	Configure a circuit-ID tunnel for decapsulation. Ensure that you select the mode as Decap and attach the circuit ports or circuit GigaStream that you configured in step 1 to the circuit-ID tunnel.	Create Tunnel
3.	Configure a map to decapsulate the traffic and ensure that you specify the circuit-ID as a pass/drop rule in the map.	Create a New Map

About Layer 2 Generic Routing Encapsulation (L2GRE) Tunnels

L2GRE tunnels are used to route traffic from any remote device to a GigaVUE-H Series or GigaVUE-TA Series device over the internet. The device at the remote site encapsulates the filtered packets, adds a L2GRE encapsulation header, and forwards it to the corresponding circuit port that is used for GRE encapsulation. The encapsulation header consists of Ethernet + IP + GRE headers. The parameters of the encapsulated header are user-configurable, such as the IPv4 address of the IP interface on the destination GigaVUE device and the GRE key that identifies the source of the tunnel.

The encapsulated packet is sent out of the circuit port, which is connected to the public network (the Internet). This packet is routed in the public network to reach the main office site. The packet is ingressed at the circuit port of the GigaVUE device at the main office. The destination IP address of the received packet is checked against the IP configured for the circuit port. If they match, decapsulation is applied. The Ethernet + IP + GRE header is stripped and the remaining packet is sent to the tool port.

If the destination IP address of the received packet does not match with the IP address configured for the IP interface, the packet is dropped.

The following figure illustrates the L2GRE tunnel encapsulation and decapsulation.

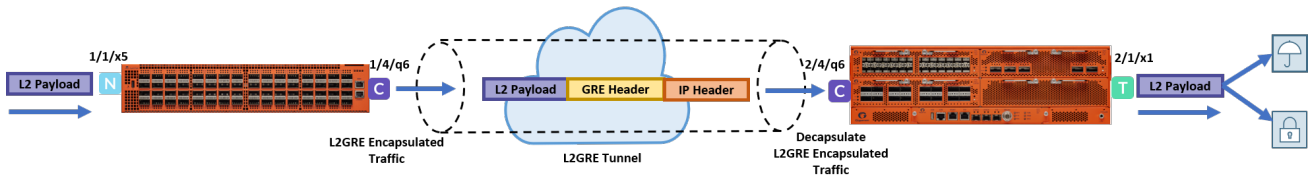


Figure 224: L2GRE Tunnel Encapsulation and Decapsulation

In this diagram, traffic is tapped on a GigaVUE-TA200 device at a remote site, and then it is tunneled through L2GRE encapsulation across the network before it reaches the GigaVUE-HC3 device at the main office site, which is connected to the actual tools. The tunnel decapsulation is executed on an ingress circuit port (IP interface). After tunnel decapsulation the packet is presented to the flow mapping module to filter based on map rule parameters.

Refer to the following sections for details about the L2GRE tunnel configuration:

- [L2GRE Tunnel Configuration—Rules and Notes](#)
- [Configure L2GRE Tunnel to Encapsulate Traffic](#)
- [Configure L2GRE Tunnel to Decapsulate Traffic](#)

L2GRE Tunnel Configuration—Rules and Notes

Keep in mind the following rules and notes when working with L2GRE tunnels:

- L2GRE tunnels are supported only on GigaVUE-HC1, GigaVUE-HC2 CCv2, GigaVUE-HC3, GigaVUE-TA40, GigaVUE-TA100, and GigaVUE-TA200 devices.
- A maximum of 1500 L2GRE IDs are supported.
- IPv6 protocol is not supported with L2GRE tunnels.
- Ingress VLAN tagging and Tool Mirror features are not supported with L2GRE tunnels.
- Filtering of Q-in-Q packets is not supported with L2GRE tunnels.
- Map-passall is not supported for the circuit port that encapsulates or decapsulates the L2GRE packet.
- When configuring a map for L2GRE encapsulation, you cannot configure a combination of a regular tool port and L2GRE encapsulation tunnel as part of the "To" ports.
- Any encapsulated packet that exceeds the MTU value configured for the IP interface will be discarded because IP fragmentation and reassembly of packets are not supported.
- L2GRE tunnel encapsulation is not supported on circuit GigaStreams.
- Flow mapping that is configured on the circuit port used for L2GRE decapsulation will filter only the inner packet attributes along with L2GRE-ID. Any other non-tunneled packets that ingress on this circuit port will not be filtered or redirected to tool ports, even if it matches the rules configured on the map.
- L2GRE tunnel decapsulation is supported only on encapsulated packets that are not tagged.
- Inner VLAN qualifier is not supported on the port in which the L2GRE tunnel decapsulation is enabled.
- L2GRE ID qualifier is available as part of existing static templates. Following table provides details about the platforms for which the static templates are available:

Template	Platform	
	GigaVUE-HC2 (CCv2)/GigaVUE-HC1/GigaVUE-TA40	GigaVUE-HC3/GigaVUE-TA100
IPv4	No	Yes
IPv6	Yes	Yes
IPv4+UDA	No	Yes
IPv4+MAC	Yes	Yes
UDA	Yes	Yes

Configure L2GRE Tunnel to Encapsulate Traffic

Before creating a L2GRE tunnel to encapsulate traffic, refer to the [L2GRE Tunnel Configuration—Rules and Notes](#).

The following table summarizes the required tasks to configure a L2GRE tunnel for encapsulating the traffic:

S.No	Task	Refer to...
1.	Configure the required circuit port.	Configure Ports
2.	Configure an IP interface and attach the circuit port that you created in task 1.	Configure IP Interface
3.	Configure a L2GRE tunnel for encapsulation and attach the IP interface that you created in task 2. Ensure that you select the Type as L2GRE and the Mode as Encapsulation .	Create Tunnel
4.	Create a L2GRE group for a device and add all the L2GRE IDs that are specific to the device.	Create VXLAN / L2GRE Group
5.	Configure the L2GRE ID either at the chassis-level or at the port-level to help identify the encapsulation tunnel. You must use one of the L2GRE IDs that you have already added in the L2GRE group for the device in task 4.	Configure L2GRE / VXLAN Identifier
6.	Configure a map to encapsulate the L2GRE traffic. Ensure that you add the following details when configuring a map: <ul style="list-style-type: none"> • If you have configured the L2GRE ID for the chassis, you can configure any network port on the chassis as the source port of the map. • If you have configured the L2GRE ID for a network port, you must configure that network port as the source port of the map. • Configure the encapsulation tunnel that you created in task 3 as the destination port of the map. • Specify the required pass/drop rule in the map to filter the traffic based on inner packet attributes or L2GRE ID for the template configured. 	Create a New Map

Configure L2GRE Tunnel to Decapsulate Traffic

Before creating a L2GRE tunnel to decapsulate traffic, refer to the [L2GRE Tunnel Configuration—Rules and Notes](#).

The following table summarizes the required tasks to configure a L2GRE tunnel for decapsulating the traffic:

S. No	Task	Refer to...
1.	Configure the required circuit port.	Configure Ports
2.	Configure an IP interface and attach the circuit port that you created in task 1.	Configure IP Interface
3.	Configure a L2GRE tunnel for decapsulation and attach the IP interface that you created in task 2. Ensure that you select the Type as L2GRE and Mode as Decapsulation .	Create Tunnel
4.	Create a L2GRE group for a device and add all the L2GRE IDs that are specific to the device.	Create VXLAN / L2GRE Group
5.	Configure a map to decapsulate the traffic. Ensure that you add the IP interface that you created in task 2 as the source of the map and specify the required pass/drop rule in the map to filter the traffic based on inner packet attributes or L2GRE ID for the template configured.	Create a New Map

About Virtual Extensible LAN (VXLAN) Tunnels

VXLAN is a simple tunneling mechanism that allows overlaying a Layer 2 (L2) network over a Layer 3 (L3) underlay with the use of any IP routing protocol. It uses MAC Address-in-User Datagram Protocol (MAC-in-UDP) encapsulation. A remote device, such as the Gigamon cloud, GigaVUE TA Series, GigaVUE H Series, or a customer-specific device, encapsulates the filtered traffic, adds an encapsulation header that consists of Layer 2 + IP + UDP + VXLAN headers. The encapsulated packet is sent out of the circuit port, which is connected to the public network (the Internet). This packet is routed in the public network to reach the main office site. The packet is ingress at the circuit port configured in the GigaVUE-H Series or GigaVUE-TA Series device at the main office. After validation of the source port, destination port, and VXLAN Network Identifier (VNI) of the packet, the VXLAN tunnel header will be removed and the inner payload will be sent to the tools based on the map rules configured.

The following figure illustrates the VXLAN tunnel encapsulation and decapsulation.

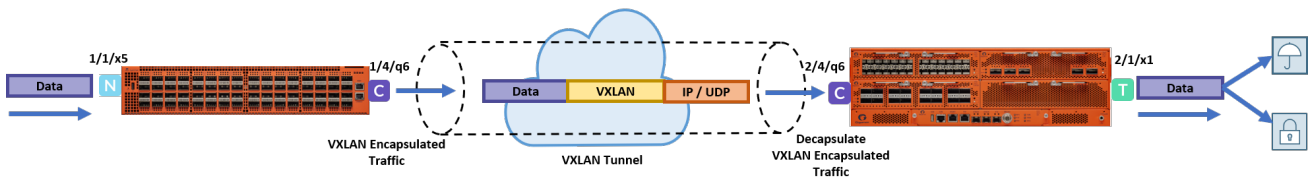


Figure 225: VXLAN Tunnel Encapsulation and Decapsulation

In this diagram, traffic is tapped on a GigaVUE-TA200 device at a remote site, and then it is tunneled through VXLAN encapsulation across the network before it reaches the GigaVUE-HC3 device at the main office site, which is connected to the actual tools. The tunnel decapsulation is executed on an ingress circuit port (IP interface). After tunnel decapsulation, the packet is presented to the flow mapping module to filter based on map rule parameters.

Refer to the following sections for details about VXLAN tunnels:

- [VXLAN Tunnel Configuration—Rules and Notes](#)
- [Configure VXLAN Tunnel to Encapsulate Traffic](#)
- [Configure VXLAN Tunnel to Decapsulate Traffic](#)

VXLAN Tunnel Configuration—Rules and Notes

Keep in mind the following rules and notes when working with VXLAN tunnels:

- VXLAN tunnels are supported only on GigaVUE-HC1, GigaVUE-HC2 CCv2, GigaVUE-HC3, GigaVUE-TA40, GigaVUE-TA100, and GigaVUE-TA200 devices.
- A maximum of 1500 VXLAN IDs are supported.
- Flow mapping that is configured on the circuit port used for VXLAN decapsulation will filter only the inner packet attributes along with VXLAN-ID. Any other non-tunneled packets that ingress on this circuit port will not be filtered or redirected to tool ports, even if it matches the rules configured on the map.
- IPv6 protocol is not supported with VXLAN tunnels.
- Ingress VLAN tagging and Tool Mirror features are not supported with VXLAN tunnels.
- Any encapsulated packet that exceeds the MTU value configured for the IP interface will be discarded because IP fragmentation and reassembly of packets are not supported.
- VXLAN tunnel encapsulation is not supported on circuit GigaStreams.
- VXLAN tunnel decapsulation is supported only on encapsulated packets that are not tagged.
- Map-passall is not supported for the circuit port that encapsulates or decapsulates the VXLAN packet.
- When a circuit port is configured for VXLAN tunnel decapsulation, you cannot use the port in any other regular map in which a network port is configured as the source port.
- Inner VLAN qualifier is not supported on the port in which the VXLAN tunnel decapsulation is enabled.

- VXLAN ID qualifier is available as part of existing static templates. Following table provides details about the platforms for which the static templates are available:

Template	Platform	
	GigaVUE-HC2 (CCv2)/GigaVUE-HC1/GigaVUE-TA40	GigaVUE-HC3/GigaVUE-TA100
IPv4	No	Yes
IPv6	Yes	Yes
IPv4+UDA	No	Yes
IPv4+MAC	Yes	Yes
UDA	Yes	Yes

Configure VXLAN Tunnel to Encapsulate Traffic

Before creating a VXLAN tunnel to encapsulate traffic, refer to the [VXLAN Tunnel Configuration—Rules and Notes](#).

The following table summarizes the required tasks to configure a VXLAN tunnel for encapsulating the traffic:

S.No	Task	Refer to...
1.	Configure the required circuit port.	Configure Ports
2.	Configure an IP interface and attach the circuit port that you created in task 1.	Configure IP Interface
3.	Configure a VXLAN tunnel for encapsulation and attach the IP interface that you created in task 2. Ensure that you select the Type as VXLAN and the Mode as Encapsulation .	Create Tunnel

S.No	Task	Refer to...
4	Create a VXLAN group for a device and add all the VXLAN IDs that are specific to the device.	Create VXLAN / L2GRE Group
5.	Configure the VXLAN ID either at the chassis-level or at the port-level to help identify the encapsulation tunnel. You must use one of the VXLAN IDs that you have already added in the VXLAN group for the device in task 4.	Configure L2GRE / VXLAN Identifier
6.	Configure a map to encapsulate the VXLAN traffic. Ensure that you add the following details when configuring a map: <ul style="list-style-type: none"> • If you have configured the VXLAN ID for the chassis, you can configure any network port on the chassis as the source port of the map. • If you have configured the VXLAN ID for a network port, you must configure that network port as the source port of the map. • Configure the encapsulation tunnel that you created in task 3 as the destination port of the map. • Specify the required pass/drop rule in the map to filter the traffic based on inner packet attributes or VXLAN ID for the template configured. 	Create a New Map

Configure VXLAN Tunnel to Decapsulate Traffic

Before creating a VXLAN tunnel termination, refer to the [VXLAN Tunnel Termination—Rules and Notes](#).

The following table summarizes the required tasks to configure a VXLAN tunnel for decapsulating the traffic:

S.N o	Task	Refer to...
1.	Configure the required circuit port.	Configure Ports
2.	Configure an IP interface and attach the circuit port that you created in task 1.	Configure IP Interface
3.	Configure a VXLAN tunnel for decapsulation and attach the IP interface that you created in task 2. Ensure that you select the Type as VXLAN and Mode as Decapsulation .	Create Tunnel
4	Create a VXLAN group for a device and add all the VXLAN IDs that are specific to the device.	Create VXLAN / L2GRE Group
5.	Configure a map to decapsulate the traffic. Ensure that you	Create a New Map

S.No	Task	Refer to...
	add the IP interface that you created in task 2 as the source of the map and specify the required pass/drop rule in the map to filter the traffic based on inner packet attributes or VXLAN ID for the template configured.	

Create Tunnel

You can create tunnels on the encapsulation side and/or decapsulation side. To create a tunnel:

1. From the device view, go to **Ports > Tunnels**.
2. Click **New**. The Tunnel configuration page appears.
3. In the **Alias** and **Comment** fields, enter the name and description of the tunnel.
4. From the **Type** drop-down list, select one of the following options:
 - **Circuit-ID**—to create Circuit-ID tunnels.
 - **VXLAN**—to create VXLAN tunnels.
 - **L2GRE**—to create L2GRE tunnels.
5. Select one of the following modes:
 - **Encapsulation**—Select this mode to send the encapsulated traffic to the destination node that resides in another cluster.
 - **Decapsulation**—Select this mode to decapsulate the traffic received from the source node that resides in another cluster.
6. In the **Circuit-ID** field, enter the circuit ID used to encapsulate or decapsulate the traffic. You can enter multiple circuit-IDs when you create a circuit-ID tunnel for decapsulation.

NOTE: This field is available only when you select **Circuit-ID** in the **Type** drop-down list.

7. In the **Destination IP Address** field, enter the IPv4 address of the destination node.

NOTE: This field is available only when you select **VXLAN** or **L2GRE** in the **Type** field and the **Mode** as **Encapsulation**.

8. In the **L4 Source Port** field, enter the layer 4 source port number.

NOTE: This field is available only when you select **VXLAN** in the **Type** field and the **Mode** as **Encapsulation**.

9. From the **Attached entity** drop-down list, select the required entity based on the tunnel type you are creating:
 - If you are creating a Circuit-ID tunnel, this field is available only when you select the **Mode** as **Decapsulation**. Ensure that you attach the required circuit ports or circuit GigaStreams.
 - If you are creating a VXLAN tunnel or a L2GRE tunnel, ensure that you select the IP interface to which you have attached the circuit port.
10. Click **OK**.

The newly added tunnel appears in the Tunnels listing page.

Create VXLAN / L2GRE Group

You can create a VXLAN or L2GRE group for a GigaVUE H Series or a GigaVUE TA Series device and add all the VXLAN IDs or the L2GRE IDs that are specific to the device. You can add a maximum of 1500 IDs per system. To create a VXLAN or L2GRE group:

1. From the device view, go to **Ports > Tunnels > VXLAN / L2GRE Groups**.
2. Click **New**. The VXLAN / L2GRE Group page appears.
3. In the **Alias** and **Comment** fields, enter the name and description of the group.
4. Select either **VXLAN** or **L2GRE** based on the group that you want to create.
5. From the **Box ID** drop-down list, select the required box ID of the device for which you want to create the group.
6. Click **Add ID**, and then enter the VXLAN ID or L2GRE ID for the device.
7. Repeat step 6 to add multiple VXLAN IDs or L2GRE IDs for the device, and then click **OK**.

The newly added group appears in the VXLAN / L2GRE Groups listing page.

NOTE: Ensure that you create a VXLAN or L2GRE group and add the required IDs to the group before you assign the VXLAN or L2GRE IDs to the map you create for tunnel termination.

Configure L2GRE / VXLAN Identifier

The L2GRE or VXLAN IDs that you have added in the L2GRE or VXLAN group created for a specific device must be configured either at the chassis-level or at the network port-level. The ID that you configure for the network port overrides the ID configured for the chassis. The L2GRE or VXLAN IDs help to identify the respective tunnels.

Configure L2GRE / VXLAN Identifier for a Chassis

To configure L2GRE or VXLAN ID for a chassis:

1. On the top navigation bar, click **Physical**.
2. In the Physical Nodes page, select the node for which you want to configure the L2GRE or VXLAN ID.
3. From the left navigation pane, go to **System > Chassis**.
4. Go to List View, and then select the Box ID for which you want to configure the L2GRE or VXLAN ID.
5. From the **Actions** drop-down list, select **Configure L2GRE/VXLAN ID**.
6. Enter either the L2GRE ID or the VXLAN ID in the respective field.

NOTE: You cannot specify both L2GRE ID and VXLAN ID for a chassis.

7. Click **OK**.

Configure L2GRE / VXLAN Identifier for a Network Port

To configure L2GRE or VXLAN ID for a network port:

1. On the top navigation bar, click **Physical**.
2. In the Physical Nodes page, select the node for which you want to configure the L2GRE or VXLAN ID.
3. From the left navigation pane, go to **Ports > Ports > All Ports**.
4. Select the network port for which you want to configure the L2GRE or VXLAN ID, and then click **Edit**. The Ports page appears with the details of the port selected.
5. Under the Parameters area of the page, enter either the L2GRE ID or the VXLAN ID in the respective field.

NOTE: You cannot specify both L2GRE ID and VXLAN ID for a network port.

6. Click **OK**.

View VXLAN / L2GRE ID Statistics

You can view the statistics such as the number of packets and bytes that were decapsulated using a VXLAN ID or a L2GRE ID for a device. To view the VXLAN /L2GRE ID Statistics page, go to **Ports > Tunnels > Statistics**. [Figure 226: VXLAN / L2GRE ID Statistics](#) illustrates the statistics.

VXLAN/L2GRE ID	Box ID	VXLAN/L2GRE Group	Type	Packets Rx	Bytes Rx	
1	1	l2gre_alpha_group	L2GRE	1000	128000	
2	1	l2gre_alpha_group	L2GRE	0	0	

Figure 226: VXLAN / L2GRE ID Statistics

The following table describes the VXLAN or L2GRE ID statistics:

Statistic	Description
VXLAN/L2GRE ID	The VXLAN or L2GRE identifier that is specific to the device.
Box ID	The box identifier of the device.
VXLAN/L2GRE Group	The name of the group created for the device.
Type	The type of group—VXLAN or L2GRE.
Packets Rx	The number of packets that were decapsulated using the VXLAN or L2GRE ID.
Bytes Rx	The total bytes that were decapsulated using the VXLAN or L2GRE ID.

To export the statistics to a CSV file, click the '+' icon and then select **Download all data as csv**.

Note: The bulk CSV download window does not generate the correct CSV file.

To clear the VXLAN statistics, click **Clear Stats > Clear All VXLAN Stats**. To clear the L2GRE statistics, click **Clear Stats > Clear All L2GRE Stats**.

Flow Mapping®

This chapter provides the following information about flow mapping:

- [About Flow Mapping®](#)
- [Manage Maps](#)
- [Flow Mapping® FAQ](#)
- [Configure Active Visibility](#)

About Flow Mapping®

This section describes what is Flow Mapping® and how to apply it to GigaVUE H Series and TA Series nodes. Refer to the following sections for details:

- [Flow Mapping® Overview](#)
- [Get Started with Flow Mapping®](#)
- [Flow Map Syntax and Construction](#)
- [Work with Map-Passalls and Port Mirroring in H-VUE](#)
- [Port Access and Map Sharing](#)
- [Map Examples](#)

Flow Mapping® Overview

Flow Mapping® is the technology found in GigaVUE nodes that takes line-rate traffic at 1Gb, 10Gb, 40Gb, or 100Gb from a network TAP or a SPAN/mirror port (physical or virtual) and sends it through a set of user-defined map rules to the tools and applications that secure, monitor, and analyze IT infrastructure. Flow Mapping® provides **superior granularity and scalability** above and beyond the capabilities of connection and ACL filter based technologies by addressing the problems inherent when going beyond small numbers of connections or when more than one traffic distribution rule is required.

Flow Mapping® can granularly filter and forward traffic to specific monitoring tools through thousands of map rules with criteria based on over 30 predefined Layer 2, Layer 3, and Layer 4 parameters including IPv4/IPv6 addresses, application port numbers, VLAN IDs, MAC addresses and more. Users can also define custom rules that match specific bit sequences in the traffic streams, applying Flow Mapping® to tunneled traffic, specialized applications and even higher-layer protocols.

In addition, IT operations can deploy Visibility as a Service (**VaaS**), taking advantage of the Flow Mapping® **role based access control (RBAC)** features on GigaVUE nodes. Users can be given access to traffic based on their needs without interfering with the monitoring operations of the other teams. This helps protect compliance and privacy protocols and allows teams to dynamically react when needed for increased efficiency.

Flow Mapping® can be combined with **GigaSMART** technology to provide packet modification and intelligent capabilities like de-duplication and packet slicing, making tools more efficient by reducing the number and size of packets they have to store and process. Header stripping and de-tunneling functions provide tools access to protocols and data they would otherwise be blind to.

When multiple GigaVUE nodes are in a **stacked or clustered configuration**, Flow Mapping® enables traffic to be sent from any network port to any tool port, expanding visibility beyond a

single rack, row, or data center. GigaSMART can be leveraged on all traffic flow, accepting traffic from any network port and regardless of where the GigaSMART hardware is located within the stack or cluster.

Get Started with Flow Mapping®

You can manage packet distribution in both the GigaVUE-OS command-line interface (CLI) and GUI (H-VUE). Both interfaces allow you to perform all packet distribution tasks:

- designating ports as network or tool ports
- setting up map rules
- mapping network ports to tool ports
- many other such functions

NOTE: These tasks can also be performed with the GigaVUE-FM APIs. For more information about the APIs, refer to *GigaVUE-FM REST API Reference in GigaVUE-FM User's Guide*.

For the setup of a few simple maps, refer to the following sections for examples:

- [Example: How to Create a Simple Map](#)
- [Example: How to Handle Overlaps when Sending VLANs and Subnets to Different Tools](#)

Check Status of Nodes and Ports

Before configuring maps, check the status of line cards, modules, and ports. To view the status of line cards and modules, select **Chassis** from Navigation pane and select Table view. For more information about the Chassis page, refer to the "Chassis" section in the *GigaVUE-OS and GigaVUE-FM Administration Guide*. To view the status of ports, select **Ports > Ports > All Ports** to see a table with details about each port. For more information about ports, refer to [About Ports](#) and [Managing Ports](#).

Designated Port Types

Ports on GigaVUE-OS nodes can be one of the following types:

- network
- tool
- stack
- inline-network
- inline-tool
- hybrid

NOTE: Not all port types are supported on all platforms. Inline-network and inline-tool port types are only supported on GigaVUE HC Series nodes.

About Shared Collectors

GigaVUE nodes let you create map rules that direct traffic on any network port or ports to any tool ports. Traffic can be dropped intentionally using the drop rule or any packets that do not match any other rule in the map can be sent to the collector. Shared collectors are set up to capture any packets that do not fulfill the map criteria but may be required by other tools.

NOTE: If a shared-collector destination for a set of network ports is not defined, non-matching traffic is silently discarded.

When assigning the priorities to map rules on GigaVUE H Series nodes, the first rule setup will also have the highest priority unless specified by the user. The shared collector rule is the only exception because it will always have the lowest priority even if configured first. This means that an incoming packet will be matched against all the rules in the same map and when not matched with any rules, it be forwarded to the designated tool port for the collector.

A GigaStream or multiple sets of GigaStream can also be set as destination for a collector port by using the GigaStream alias.

In cases, where multiple network ports are sharing the multiple maps, packets that do not fit any of the maps can be sent to the shared collector.

No Map Statistics for Shared-Collector Only

A shared collector is intended to be used with other maps. For example, use a shared collector with a regular map containing at least one rule. If there is a shared collector but no other map, there will be no map statistics.

Shared Collector Configuration

A shared-collector is a special type of map configured with only a set of **Source** ports shared-collector ports or GigaStream. Rules, priority settings, GigaSMART operations and destination ports are not allowed in shared-collector maps. In H-VUE, the collector ports can be selected from a list of tool or hybrid ports.

To create a shared-collector map, do the following:

1. Select **Maps > Maps > Maps**.
2. Click **New**.
3. Type an alias in the Alias field to identify this map. For example, shared_collector.

4. For **Type**, select **Regular**.
5. For **Subtype**, select **Collector**.
6. Click in the **Source** field and select a network port.
7. Click in the **Destination** field and select the tool or hybrid ports that will be the shared-collector ports for the map. The map should look similar to the map shown in the following figure.

▼ Map Info

Map Alias

Comments

Type

Sub Type

▼ Map Source and Destination

Port Editor

Source

Destination

GSOP

▼ Map Rules

Quick Editor Import Add a Rule

▼ Map Order

Priority

NOTE: Shared-collector maps do not include any rules, priority settings, or GigaSMART operations. These are grayed out in the UI when Collector is select for the map's subtype.

8. Click **Save**.

In [Figure 227: Shared Collector Map](#), the Maps page shows the shared-collector map shared_collector with the standard components. The **Source** ports match those used by a set of normal flow maps. The **Destination** ports are the collector ports are where you want to send any packets not matching the normal flow maps.

Alias	Comments	Type	Sub Type	Source	No of Rules	GSOP	Priority	Access Level	Destination
GTP-Sampling-2		secondLevel	flowSample	vport_elias_test	1	gtp_flow_sampling_elias_test	1	admin	T 1/1/x4
OpenStack_vTraffic_toWireshark		regular	byRule	vTunnelEndpointForOpenStack	1	GigavueVM_Tunnel	1	admin	T toRSASecurityAnalytics
shared_collector		regular	collector	1/1/x8	0			admin	T 1/1/x7, T 1/1/x10, T 1/1/x17, T 1/1/x18

Figure 227: Shared Collector Map

About Map-passall Maps

Map-passall maps provide a way to specify a destination for packets without any filtering on a set of network ports. As indicated by the name, all traffic is passed through. A map-passall may share the network ports with a map which filters using map rules.

The same logic as set for Shared Collector can be set for map-passall. That is, that Map-passall can be set to a GigaStream alias or multiple GigaStream aliases or a single tool port or multiple tool ports. To set the **Destination**, use the same map range configuration.

Map-Passall and Shared-Collector Only

If a map-passall and a shared-collector both use the same network source port and there are no other maps, such as a regular map containing at least one rule, all traffic will be passed to the shared-collector.

Map-passalls Configuration

A map-passall map is a special type of map configured with only a set of **Source** ports and **Destination ports** or **GigaStream**. Map rules and GigaSMART operations are not allowed in passall maps.

Map-passalls in H-VUE

The web-based H-VUE interface for GigaVUE-OS nodes provides an all traffic **Pass All** subtype selection for regular maps that performs the same function as a **map-passall** in the CLI. Making this selection in H-VUE turns the map into a map-passall, delivering all traffic from the selected network ports to another tool port or GigaStream on any line card in the same node, irrespective of the other packet distribution. Although the names are different in H-VUE and the CLI, the two features are identical.

Define Map Source Port Lists

You can configure more than one map with the same source ports in the **Source** field in a map.

The source port list of one map must be exactly the same as the source port list of another map (have the same ports as well as the same number of ports) and it must not overlap with the source port list of any other map.

For example if map1 has **Source** ports 1/1/x4, 1/1/x5, and 1/1/x6 already configured:

- map2 **Source** ports 1/1/x5, and 1/1/x6 can also be configured
- map3 **Source** ports 1/1/x3, 1/1/x4, 1/1/x5 cannot be configured because ports x4 and x5 are in both maps (they overlap)

Share Network Ports Between Maps

Network ports can be shared between a regular map and a map passall, as follows:

- the regular map has network ports 1/1/x3..x4
- the passall map has network port 1/1/x4

When there are overlapping network ports and shared tool ports between a regular map and passall map, the map passall tool ports or GigaStream will receive traffic from the network ports configured on the regular map, in addition to the traffic from its own network port or ports.

In the configuration above, the map passall will also receive traffic from 1/1/x3.

NOTE: A shared collector map and a regular map should have exactly the same set of network ports. (This is the correct use case.) Overlapping network ports should not be configured for collector maps. (This is an incorrect use case whether the overlapping ports are a subset or a superset of the network ports.) Network ports cannot be shared between a regular map and a shared collector map.

Share Tool Ports Between Maps

When a map passall and shared collector share the same tool ports, removing the shared tool ports from the passall map may affect the shared collector traffic. The workaround is to not share the same tool ports between a map passall and a shared collector.

Map Priority

Packets matching multiple maps in a configuration are sent to the map with the highest priority when the network ports are shared among multiple maps with pass-by map rules. By default, the first map configured has the highest priority; however, you can adjust this.

In H-VUE, the UI displays the maps from highest priority to lowest as top to bottom.

Maps sharing the same source port list are grouped together for the purpose of prioritizing their rules. Traffic is subjected to the rules of the highest priority map first and then the rules of the next highest priority map and so on. Within a map, drop rules are applied first and then pass rules, in other words, drop rules always have higher priority than pass rules. Currently when a map's source port list is defined the map is grouped/prioritized with other maps sharing the same source port list. Newly configured maps are added as the lowest priority map within the group when initially configured unless changed by the user.

NOTE: Shared collector will always go to the lowest priority when setting up maps.

Adjust Map Priority in GigaVUE-HVUE

Before you get started adjusting map priority, start by reviewing the current map priorities in place by opening the Maps page and viewing the priority of the maps in the Priority field. For example, [Figure 228: Map Priorities](#) shows three maps MyMap1, MyMap2, and MyMap3 with the same source port 1/1/x8. The Priority column in the table shows the current priority of each map.

<input type="checkbox"/>	Alias	Comments	Type	Sub Type	Source	No of Rules	GSOP	Priority	Access Level	Destination
<input type="checkbox"/>	GTP-Sampling-2		secondLevel	flowSample	vport_elias_test	1	gtp_flow_sampling_elias_test	1	admin	T 1/1/x4
<input type="checkbox"/>	MyMap1		regular	byRule	N 1/1/x8	0		1	admin	T 1/1/x7
<input type="checkbox"/>	MyMap2		regular	byRule	N 1/1/x8	0		2	admin	T 1/1/x10
<input type="checkbox"/>	MyMap3		regular	byRule	N 1/1/x8	0		3	admin	T 1/1/x15
<input type="checkbox"/>	OpenStack_vTraffic_toWireshark		regular	byRule	N vTunnelEndpointForOpenStack	1	GigavueVM_Tunnel	1	admin	T toRSA SecurityAnalytics

Figure 228: Map Priorities

Then, once you have reviewed the existing hierarchy of map priorities, you can fine-tune the priority of maps by using the **Priority** field in the map to select one of the following:

- Highest (top)—set the map to the highest priority
- After map - <map-alias> — set the map priority after the map with the specified alias.
- Lowest (bottom)—set the map priority to the lowest priority

Flow Map Syntax and Construction

This section provides information about map types, map rules, and working with map passalls.

Map Types

Map configuration consists of several parameters, including the following:

- **Source**—Specifies the source ports for the map.
- **Destination**—Specifies the destination ports for the map.
- **Type**—Specifies the type of map.

- **Subtype**—Specifies map subtype.
- **GSOP**—Specifies a GigaSMART operation.

Starting in software version 4.4, there are four types of maps, with the map type being determined by the **Source** and **Destination** as well as the map rules as follows:

- **Regular**—Specifies a regular map type, with the **Source** parameter specifying network or hybrid ports, or single inline-network or single inline-tool ports (for out-of-band maps) and the **Destination** parameter specifying tool, hybrid, or GigaStream ports.

When the subtype for a **Regular** map type is **By Rule**, a **Pass Traffic** option for **No Rule Matching** is available. Selecting Pass Traffic specifies what to do with traffic that does not match any rule in a map that only has drop rules. This argument changes the default behavior of drop to pass in a drop-only map. If you do not use this argument and there are only drop rules in a map, the default behavior is that all traffic not matching the rules will be dropped, or, if a shared collector is configured, traffic will be sent to the shared collector. However, if you use the Blacklisting option and there are only drop rules in a map, traffic will be passed rather than dropped.

- **inline**—Specifies an inline map type, with the **Source** parameter specifying inline-network pairs or inline-network-groups and the **Destination** parameter specifying inline-tool pairs, inline-tool-group, inline-serial, or bypass.
- **First Level**—Specifies a first level map type, with the **Source** parameter specifying network or hybrid ports and the **Destination** parameter specifying virtual ports, used with GigaSMART operations.

When a First Level map type is selected, a **Traffic Type** option is available. This option is for GTP applications to pass GTP control traffic (GTP-c) to all GigaSMART engines in a GTP engine group. To enable GTP-c, select **Control**.

Starting in software version 5.3, a fifth map type is added as follows:

- **flexinline**—Specifies a flexible inline map, with the **from** parameter specifying inline-network and the **a-to-b** or **b-to-a** parameters specifying an ordered list of inline-tool or inline-tool-group.

Define Map Source Port Lists for First Level Maps

You can configure more than one map with the same source ports in the **Source** field in a map.

The source port list of one map must be exactly the same as the source port list of another map (must have the same ports as well as the same number of ports) and it must not overlap with the source port list of any other map.

For example:

- map1 has Source ports 1/1x1,1/1x2 already configured.
- map 2 with Source ports 1/1x1,1/1x2 can also be configured.
- map3 with Source port 1/1/x3 can be configured. If you try to add source ports 1/1x1,1/1x2 as part of map3 then it is not possible because, 1/1x1,1/1x2 are already part of map 1.

NOTE: This is also applicable for regular maps.

- **Second Level**—Specifies a second level map type, with the **Source** parameter specifying virtual ports, used with GigaSMART operations, and the **Destination** parameter specifying tool, hybrid, or GigaStream ports.

NOTE: There is also a **Template** map type for creating map templates.

Map types are described in [Table 46: Matrix of Map Types](#).

Table 46: Matrix of Map Types

Type	Subtype	Map Rule	GSO P	Source	Destination
Regular	By Rule, or Pass All, or Collector	Rule	yes	network ports, or hybrid ports, or single inline-network ports or single inline-tool ports (for out-of-band maps)	tool ports, or hybrid ports, or GigaStream
Inline	By Rule, or Pass All, or Collector	Rule	no	inline-network pairs, or inline-network-groups	inline-tool pairs, or inline-tool-groups, or bypass, or inline-serial tools
First Level	By Rule	Rule	no	network ports, or hybrid ports	virtual ports only (collector is not allowed)
Second Level	By Rule, or Collector	gsrule	yes	virtual ports	tool ports, or hybrid ports, or GigaStream, or port group
	Flow Filter	flowrule	yes		
	Flow Sample	flowsample	yes		
	Flow Sample	flowsample	yes		

Type	Subtype	Map Rule	GSO P	Source	Destination
	Overlap				
	flowSample-sip	flowsample	yes		
	Flow Whitelist	whitelist	yes		
	Flow Whitelist Overlap		yes		
flexinline	inline-network	ordered list of inline-tool or inline-tool-group in a-to-b or b-to-a direction or both	rule	byRule	no
			-	collector	no

Map Subtypes

The map subtype describe in [Matrix of Map Types](#) is optional. It specifies the following:

- **By Rule**—Specifies a rule-based map subtype, which is supported on the following map types:
 - **First Level, inline, and Regular** map types.
 - **Second Level** map type.
- **Pass All**—Specifies a passall map subtype, which applies to **regular** and **inline** map types. The **Pass All** subtype is not supported on **First Level** and **Second Level** map types. With this subtype, map priority cannot be configured or modified.
- **Collector**—Specifies a collector map subtype, which applies to **Regular, inline, and Second Level** map types. The **Collector** subtype is not supported on the **First Level** map type. With this subtype, map priority cannot be configured or modified.
- **Flow Filter**—Specifies a flow filtering map subtype, which applies to **Second Level** map types. Specify the **Flow Filter** map subtype when using a **Flow Filter** parameter.
- **Flow Sample**—Specifies a flow sampling map subtype, which applies to **Second Level** map types. Specify the **Flow Sample** map subtype when using a **Flow Sample** parameter.
- **Flow Sample Overlap**—Specifies a flow sampling overlap map subtype, which applies to **secondLevel** map types. Specify the **flowSample-ol** map subtype when using a **flowsample** rule.
- **Flow Sample sip**—Specifies a SIP flow sampling map subtype, which applies to **secondLevel** map types.

- **Flow Sample Overlap**—Specifies a flow sampling overlap map subtype, which applies to **Second Level** map types. Specify the **Flow Sample Overlap** map subtype when using a `flowsample` rule.
- **Flow Whitelist**—Specifies a whitelist map subtype, which applies to **Second Level** map types. Specify the **Flow Whitelist** map subtype when using a whitelist rule.
- **Flow Whitelist Overlap**—Specifies a whitelist overlap map subtype, which applies to **Second Level** map types. Specify **Flow Whitelist Overlap** when using a whitelist rule.
- **Flow Whitelist-sip**—Specifies a SIP flow whitelist map subtype, which applies to **secondLevel** map types.

The default map subtype is **By Rule**.

NOTE: Maps with subtype **Flow Sample Overlap** or **Flow Whitelist Overlap** do not support map editing.

Map Type and Subtype Modification

Once a map is created, the map **Type** and **Subtype** cannot be modified. However, you can delete the map and recreate it with a different **Type** and **Subtype**.

Backwards Compatibility

For backwards compatibility, the map **type** parameter does not have to be configured. The **type** and **subtype** will be determined by the system based on the remainder of the map configuration parameters. If not enough information is available, the default values of **regular** and **byRule** will be assumed for the type and subtype.

Minimum Requirements for Map Creation

A map must be configured with at least a **from** parameter. Even if other parameters such as **to**, **rule**, or **use** are configured, without **from**, the map will not be created.

Map Rules

This section provides information about the different types of map rules that you can specify when creating maps in GigaVUE-FM. The following topics are covered:

- [Other Types of Map Rules for GigaSMART Operations](#)
- [IPv4/IPv6 and Map Rules](#)
- [Set Map Rules for TCP Control Bits](#)
- [How to Use Bit Count Netmasks](#)

- [How to Combine Rules and Rule Logic](#)
- [How to Mix Pass and Drop Rules](#)
- [Work with User-Defined Pattern Match Rules](#)

Other Types of Map Rules for GigaSMART Operations

There are other types of rules for GigaSMART operations as follows:

- Adaptive Packet Filtering (APF) and Adaptive Session Filtering (ASF). For details, refer to [GigaSMART Adaptive Packet Filtering \(APF\)](#) and [GigaSMART Application Session Filtering \(ASF\) and Buffer ASF](#)
- GTP correlation. For details, refer to [GigaSMART GTP Correlation](#).
- GTP whitelisting and GTP flow sampling. For details, refer to [GigaSMART GTP Whitelisting and GTP Flow Sampling](#).

IPv4/IPv6 and Map Rules

GigaVUE-OS provides a variety of criteria for pass/drop rules specific to IPv6 traffic, including:

IPv6 Entity	Rule Condition
IPv6 Source/Destination Addresses	IPv6 Source/IPv6Destination
IPv6 Flow Labels	IPv6 Flow Label
IPv6 Traffic	IP Version and Version it set to v6

In addition to the explicit IPv6 filters listed in the table, you can use the **IP Version** condition to change how some of the other attributes are interpreted.

When **IP Version** is used by itself in a map rule, it returns all traffic matching the specified IP version, **4** or **6**. However, when **IP Version** is set to **6**, several of the other arguments are interpreted differently when used in the same rule, as follows:

Condition	IP Version set to 4 (or not specified)	IP Version set to 6
Port Destination/Port Source	Matches all IPv4 traffic on the specified port number.	Matches all IPv6 traffic on the specified port number.
IPv4 Protocol	When used with the <1-byte-hex> argument, matches against the protocol field in the standard IPv4 header.	When used with the <1-byte-hex> argument, matches against the Next Header field in the standard IPv6 header.

Condition	IP Version set to 4 (or not specified)	IP Version set to 6
	<p>NOTE: These fields perform essentially the same service in both versions, specifying what the next layer of protocol is. However, they have different names and are found at different locations in the header. Refer to Protocol Map Rules and IPv6 for a list of the useful values for the <1-byte-hex> field.</p>	
IPv4 TTL	Matches against the standard TTL (time-to-live) field in the IPv4 header.	Matches against the standard Hop Limit field in the IPv6 header.
	<p>NOTE: These fields perform essentially the same service in both versions, specifying how long a datagram can exist.</p>	

NOTE: The **IP Version** argument is implicitly set to **4** – if you configure a map rule without **IP Version** specified, the GigaVUE H Series node assumes that the IP version is 4.

Protocol Map Rules and IPv6

The predefined protocol map-rules available for IPv4 (GRE, RSVP, and so on) are not allowed when **IP Version** is set to **6**. This is because with the next header approach used by IPv6, the next layer of protocol data is not always at a fixed offset as it is in IPv4.

To address this, the GigaVUE H Series node provides the <1-byte-hex> option to match against the standard hex values for these protocols in the Next Header field. The standard 1-byte-hex values for both IPv4 and IPv6 are set by selecting the option from the **Value** list or specifying a decimal value when **IPv4 Protocol** is selected. The following are options or values that you can select from the **Value** list.

- IPv6Hop 0
- ICMP_IPv4 1
- IGMP 2
- IPv4 4
- TCP 6
- UDP 17
- IPv6 41
- RSVP 46
- GRE 47
- ICMP_IPv6 58

You can also specify a custom value (0-255) by selecting **Custom**. The following are some additional values and their meanings:

- 43: Routing Option (v6 only)
- 44: Fragment (v6 only)
- 50: Encapsulation Security Payload (ESP) Header (v6 only)
- 51: Authentication (v6 only)
- 59: No Next Header (v6 only)
- 60: Destination Option (v6 only)

Set Map Rules for TCP Control Bits

Select the **TCP Control** to set map rules matching one-byte patterns for the standard TCP control bits. The following table summarizes the bit positions of each of the flags, along with their corresponding hexadecimal patterns.

NOTE: Rules using the **TCP Control** must also include **IPv4 Protocol** and the Value set to **TCP 6**.

Flag	Bit Position	Pattern	TCP Control Mask
Congestion Window Reduced	X... ..	0x80	0x3f
ECN Echo	.X.	0x40	0x3f
Urgent Pointer	..X.	0x20	0x3f
Acknowledgment	...X	0x10	0x3f
Push X...	0x08	0x3f
Reset X..	0x04	0x3f
SYNX.	0x02	0x3f
FINX	0x01	0x3f

Examples

The map rule shown in [Figure 229: Map Rule with SYN Bit Set](#) matches packets with only the SYN bit set:

The screenshot shows the 'Map Rules' configuration page. At the top, there are buttons for 'Quick Editor', 'Import', and 'Add a Rule'. Below this, there are two rule configurations:

- Rule 1:**
 - Condition search... (dropdown)
 - Pass (selected), Drop, Bi Directional
 - Rule Comment: Comment
 - IPv4 Protocol: Value TCP, 6
- Rule 2:**
 - Condition search... (dropdown)
 - Pass (selected), Drop, Bi Directional
 - Rule Comment: Comment
 - TCP Control: Value 02, Mask 3f

Figure 229: Map Rule with SYN Bit Set

Many packets will have some combination of these bits set rather than just one. So, for example, the map rule in [Figure 230: Map Rule Matching All Packets with Both ACK and SYN Bits set](#) matches all packets with both the ACK and SYN bits set.

The screenshot shows the 'Map Rules' configuration page. At the top, there are buttons for 'Quick Editor', 'Import', and 'Add a Rule'. Below this, there are two rule configurations:

- Rule 1:**
 - Condition search... (dropdown)
 - Pass (selected), Drop, Bi Directional
 - Rule Comment: Comment
 - IPv4 Protocol: Value TCP, 6
- Rule 2:**
 - Condition search... (dropdown)
 - Pass (selected), Drop, Bi Directional
 - Rule Comment: Comment
 - TCP Control: Value 12, Mask 3f

Figure 230: Map Rule Matching All Packets with Both ACK and SYN Bits set

How to Use Bit Count Netmasks

The following table summarizes the bit count netmask value for standard dotted-quad IPv4 netmasks. You can enter IP netmasks in the bit count format by using the **/nn** argument.

Bit count netmasks are easier to visualize for IPv6 addresses, specifying which portion of the total 128 bits in the address correspond to the network address. So, for example, a netmask of /64 indicates that the first 64 bits of the address are the network address and that the remaining 64 bits are the host address. This corresponds to the following hexadecimal netmask:

```
ffff:ffff:ffff:ffff:0000:0000:0000
ffff:ffff:ffff:ffff:0000:0000:0000
```


Standard Netmask	Bit Count Netmask
255.255.255.255	/32
255.255.255.254	/31
255.255.255.252	/30
255.255.255.248	/29
255.255.255.240	/28
255.255.255.224	/27
255.255.255.192	/26
255.255.255.128	/25
255.255.255.0	/24
255.255.254.0	/23
255.255.252.0	/22
255.255.248.0	/21
255.255.240.0	/20
255.255.226.0	/19
255.255.192.0	/18
255.255.128.0	/17
255.255.0.0	/16
255.254.0.0	/15
255.252.0.0	/14
255.248.0.0	/13
255.240.0.0	/12
255.226.0.0	/11
255.192.0.0	/10
255.128.0.0	/9
256.0.0.0	/8
254.0.0.0	/7
252.0.0.0	/6

Standard Netmask	Bit Count Netmask
248.0.0.0	/5
240.0.0.0	/4
226.0.0.0	/3
192.0.0.0	/2
128.0.0.0	/1
0.0.0.0	/0

How to Combine Rules and Rule Logic

When working with maps, you can easily combine multiple criteria into a single rule. GigaVUE-OS processes rules as follows:

- Within a single rule, criteria are joined with a logical **AND**. A packet must match each of the specified criteria to satisfy the rule.
- Within a map, rules are joined with a logical **OR**. A packet must match at least ONE of the rules to be passed or dropped.

NOTE: When used in a map rule with multiple criteria, the **ipver** argument changes the interpretation of some map rule arguments. Refer to [IPv4/IPv6 and Map Rules](#) for details.

Examples of Map Rule Logic

For example, the rules shown in the following table are both set up with criteria for **vlan 100** and **portsrc 23**.

- The first example combines the two criteria into a single rule. This joins the criteria with a logical **AND**.
- The second example creates two separate rules – one for each of the criteria. This joins the criteria with a logical **OR**.

How to Mix Pass and Drop Rules

GigaVUE-OS lets you mix pass and drop rules on a single port. Mixing pass and drop rules can be useful in a variety of situations. [Figure 231: Pass and Drop Rules in a Map](#) shows a pass rule set up to include all traffic matching a particular source port range combined with a drop rule configured to exclude ICMP traffic.

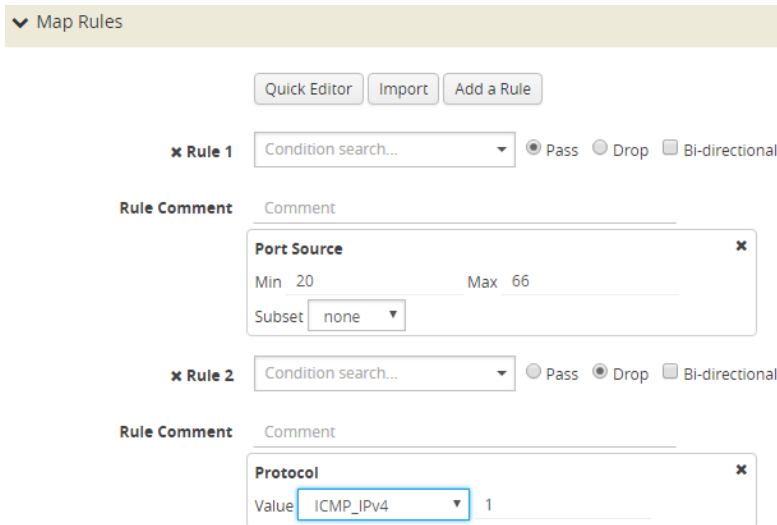


Figure 231: Pass and Drop Rules in a Map

Drop Rules Have Precedence!

Keep in mind that within a map, drop rules have precedence over pass rules. So, if a packet matches both a pass and a drop rule in the same map, the packet is dropped rather than passed.

Work with User-Defined Pattern Match Rules

GigaVUE-OS lets you create pass and drop map rules with *pattern matches* to search for a particular sequence of bits at a specific offset in a packet. You can configure up to two user-defined, 16-byte **pattern matches** in a map rule. A **pattern** is a particular sequence of bits at a specific location in a frame.

NOTE: Refer to [User-Defined Pattern Match Examples](#) for step-by-step instructions on creating a real-world pattern-match map rule.

User-defined pattern matches consist of the following components:

Step	Description
Pattern	Use the UDA1 Value and UDA2 Value fields for map rule to set up the actual bit patterns you want to search for. Refer to User-Defined Pattern Match Examples for details.
Mask	Use the UDA1 Mask and UDA2 Mask fields for map rules to specify which bits in the pattern must match to satisfy the map rule.
Offset	Use the UDA1 Offset and UDA2 Offset fields for map rules to specify where in the packet bits must match.

Step	Description
	<p>NOTE: The GigaVUE H Series node accepts a maximum of two offsets per line card or GigaVUE-HB1 node. When both of the available offsets for a line card are in use with existing map rules, you will not be able to add a new rule with a different value for UDAx Offset until at least one of the UDAx Offset is freed up from all existing map rules.</p>

User-Defined Pattern Match Syntax

The user-defined pattern match syntax is as follows:

- Both the **UDAx Value** and **UDAx Mask** arguments are specified as 16-byte hexadecimal sequences. Specify the pattern in four 4-byte segments separated by hyphens. For example: **0x01234567-89abcdef-01234567-89abcdef**
- Masks specify which bits in the pattern must match. The mask lets you set certain bits in the pattern as wild cards – any values in the masked bit positions will be accepted.
 - Bits masked with binary 1s must match the specified pattern.
 - Bits masked with binary 0s are ignored.
- You can set up the two global offsets allowed per line card or GigaVUE-HB1 node at 4-byte boundaries beginning at frame offset 2 and ending at offset 110. The resulting data range for pattern matches is from byte 3 through byte 126.
 - Multiple offsets must be set either equal to one another, or set beyond the boundaries of each other. For example, if **UDA1 Offset** starts at byte 2, the **UDA2 Offset** can only start either at byte 2 or at any point beginning with byte 18 (which would be the next 4-byte boundary after the 16-byte pattern used at **UDA1 Offset**).
 - Offsets are always frame-relative, not data-relative.
 - In many cases, you will be looking for patterns that do not start exactly on a four-byte boundary. To search in these position, you would set an offset at the nearest four-byte boundary and adjust the pattern and mask accordingly.

User-Defined Pattern Match Rules

Keep in mind the following rules when creating user-defined pattern matches:

- Offsets are specified in decimal; patterns and masks are specified in hexadecimal.
- All hexadecimal values must be fully defined, including leading zeroes. For example, to specify 0xff as a 16-byte value, you must enter 00000000-00000000-00000000-000000ff.
- User-defined pattern-match criteria are not allowed in egress port-filters.

- You can use user-defined pattern matches as either standalone map rules or in tandem with the other available predefined criteria for map rules (for example, port numbers, IP addresses, VLAN IDs, and so on).
- You can use up to two separate user-defined pattern matches in a single map rule. When two user-defined pattern matches appear in the same map rule, they are joined with a logical AND. However, the two patterns cannot use the same offset.
- User-defined pattern matches are combined in map rules using the same logic described in [How to Combine Rules and Rule Logic](#).
- Avoid using user-defined pattern matches to set map rules for elements that are available as predefined criteria (for example, IP addresses, MAC addresses, and so on).
- GigaVUE H Series nodes accept a maximum of two offsets per line card or GigaVUE-HB1 node. When both of the available offsets for a line card are in use with existing map rules, you will not be able to add a new rule with a different value for **UDAx Offset** until at least one of the **UDAx Offsets** is freed up from all existing map rules.

User-Defined Pattern Match Examples

In this example, a 3G carrier is monitoring the Gn interface between the SGSN and the GGSN in the mobile core network and wants to split traffic from different subscriber IP address ranges to different tool ports. However, because the subscriber IP addresses are tunneled using the GPRS Tunneling Protocol (GTP), standard IP address map rules will not work. The addresses are always at the same offsets, though, so we can construct UDA pattern match rules to match and distribute the traffic correctly.

For example, suppose we want to apply the following rules to all traffic seen on network port 1/5/x1:

- Send all traffic to and from the 10.218.0.0 IP address range inside the GTP tunnel to tool port 1/5/x4.
- Send all traffic to and from the 10.228.0.0 IP address range inside the GTP tunnel to tool port 1/5/x9.

Keep in mind that we also know the following about tunneled GTP traffic:

- The offset for source IP addresses inside the GTP tunnel is 62.
- The offset for destination IP addresses inside the GTP tunnel is 66.

The following example explains how to construct two maps that will distribute traffic using UDA pattern match rules.

Description	UI Step
<h2>Map #1 – GTP_Map218</h2> <p>Our first map will send traffic to and from the 10.218.0.0 IP address range inside the GTP tunnel to tool port 1/5/x4.</p>	
<p>Create a map with the alias GTP_Map218.</p>	<ol style="list-style-type: none"> 1. Select Maps > Maps > Maps. 2. Click New. 3. Enter GTP-MAP218 in the Alias field.
<p>Specifies the map type and subtype.</p>	<ol style="list-style-type: none"> 4. Select Regular for Type. 5. Select By Rule for Subtype.
<p>Specify that this map will match packets arriving on network port 1/5/x1.</p>	<ol style="list-style-type: none"> 6. Select 1/5/x1 for Source.
<p>Specify that packets matching this map will be sent to tool port 1/5/x4.</p>	<ol style="list-style-type: none"> 7. Select 1/5/x4 for Destination.
<p>Next, add the map rules for our first address range – 10.218.0.0. This IP address translates to 0ada in hex. The first rule matches the 10.218.0.0 address at the source address offset of 62 in the GTP tunnel.</p>	<ol style="list-style-type: none"> 8. Click Add a Rule to add the first rule. 9. Select Pass. 10. Select UDA1 and set the values: Value: 0ada0000-00000000-00000000-00000000 Mask: ffff0000-00000000-00000000-00000000 Offset: 62
<p>The second rule matches the same address range (10.218.0.0) but at the destination address offset of 66 in the GTP tunnel. Notice that we have still specified the offset as 62 and have simply masked out to the correct location of the destination address. This way, we have still only used one of the two possible offsets in place for the GigaVUE H Series node at any one time.</p>	<ol style="list-style-type: none"> 11. Click Add a Rule to add the second rule. 12. Select UDA1 and set the values: Value: 00000000-0ada0000-00000000-00000000 Mask: 00000000-ffff0000-00000000-00000000 Offset: 62
<p>Save the map.</p>	<ol style="list-style-type: none"> 13. Click Save.

Map #2 – GTP_Map228

Our second map will send traffic to and from the 10.228.0.0 IP address range inside the GTP tunnel to tool port 1/5/x9.

Description	UI Step
Create a map with the alias GTP_Map228 .	<ol style="list-style-type: none"> 1. Select Maps > Maps > Maps. 2. Click New. 3. Enter GTP-MAP228 in the Alias field.
Specifies the map type and subtype.	<ol style="list-style-type: none"> 4. Select Regular for Type. 5. Select By Rule for Subtype.
Specify that this map will match packets arriving on network port 1/5/x1.	<ol style="list-style-type: none"> 6. Select 1/5/x1 for Source.
Specify that packets matching this map will be sent to tool port 1/5/x9.	<ol style="list-style-type: none"> 7. Select 1/5/x9 for Destination.
Now, create rules for the second address range – 10.228.0.0 (0ae4 in hex). As with the first range, create separate rules for the source and destination offsets inside the GTP tunnel. This address range is being sent to 1/1/x4.	<ol style="list-style-type: none"> 8. Click Add a Rule to add the first rule. 9. Select Pass. 10. Select UDA1 and set the values: Value: 0ae40000-00000000-00000000-00000000 Mask: ffff0000-00000000-00000000-00000000 Offset: 62
Here is the companion rule for the destination address offset of 66.	<ol style="list-style-type: none"> 11. Click Add a Rule to add the second rule. 12. Select UDA1 and set the values: Value: 00000000-0ae40000-00000000-00000000 Mask: 00000000-ffff0000-00000000-00000000 Offset: 62
Save the map.	<ol style="list-style-type: none"> 13. Click Save.

How to Handle Q-in-Q Packets in Maps

In software versions prior to 4.7, for traffic that matched the map pass rule shown in [Figure 232: VLAN Pass Rule](#), only Q-in-Q packets of TPID ethertype 0x8100 were passed and all tagged packets with a TPID ethertype other than 0x8100, such as 0x88A8 and 0x9100, were dropped:

Map Rules

Quick Editor Import Add a Rule

× Rule 1 Condition search... Pass Drop Bi Directional

Rule Comment Comment

VLAN

Min 100 Max 1 to 4094

Subset

Figure 232: VLAN Pass Rule

Conversely, for traffic that matched the map drop rule shown in [Figure 233: VLAN Drop Rule](#), only Q-in-Q packets of TPID ethertype 0x8100 were dropped:

Map Rules

Quick Editor Import Add a Rule

× Rule 1 Condition search... Pass Drop Bi Directional

Rule Comment Comment

VLAN

Min 100 Max 1 to 4094

Subset

Figure 233: VLAN Drop Rule

Starting in software version 4.7, the rules shown in [Figure 232: VLAN Pass Rule](#) and [Figure 233: VLAN Drop Rule](#) will pass (or drop) TPID ether types 0x8100, 0x88A8, and 0x9100.

You do not specify TPID ether types 0x8100, 0x88A8, and 0x9100 explicitly in a rule. If you specify these values in the **Value** field an **Ether Type** rule, the map is blocked and one of the following error messages is displayed:

Invalid ethertype : '0x8100'. Please use attribute 'vlan' instead.

Invalid ethertype : '0x88A8'. Please use attribute 'vlan' instead.

Invalid ethertype : '0x9100'. Please use attribute 'vlan' instead.

NOTE: The **Value** field accepts values with out the leading 0x only.

In summary, for single-tagged (0x8100) or double-tagged (0x88A8 and 0x9100) VLAN packets, you only configure the VLAN as the matching criteria, not the ethertype.

For handling of priority tagged packets, refer to [Priority Tagged Packets](#).

For filtering of Q-in-Q packets on inner VLAN tag, refer to [Flow Mapping® on Inner VLAN Tags](#).

Upgrade Note

If you had previously defined TPID **Ether Types** in the earlier software version, during an upgrade to 4.7, they will be converted (or removed) as follows:

- In earlier software version, rules with both a TPID ether type and VLAN such as the rules shown in [Figure 234: Rules with both TPID Ether Type and VLAN in Earlier Software Version](#) will be converted in 4.7 to the rules shown in [Figure 235: Rules Converted in version 4.7](#) (with the TPID Ether Types removed from the rule).

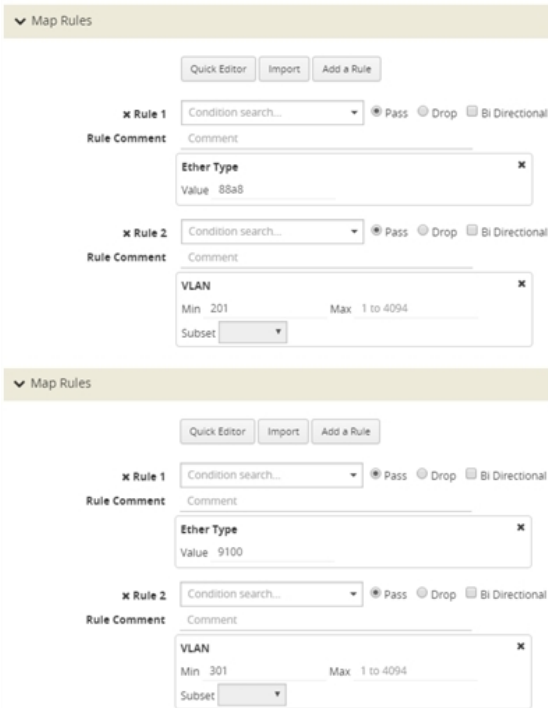


Figure 234: Rules with both TPID Ether Type and VLAN in Earlier Software Version

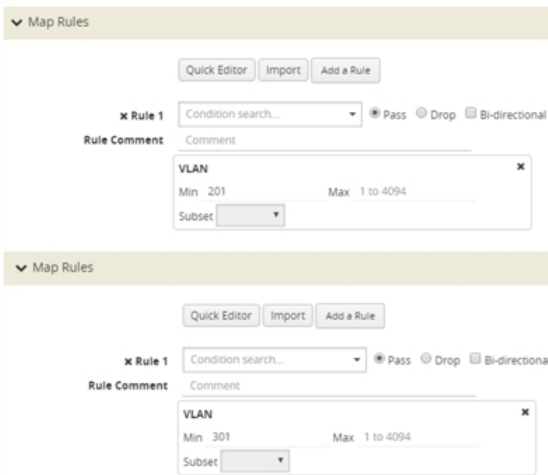


Figure 235: Rules Converted in version 4.7

- In the earlier software version, rules with only a TPID Ether Type Value, such as 88a8 or 9100, will be removed from the map in version 4.7.

It is recommended that you revisit your configuration after the upgrade.

Comparison of Q-in-Q Tagging

The following table details the various combinations and corresponding behaviors for software versions 4.7 and higher compared to 4.6.01 and earlier releases.

Packet Content	4.7 and Higher			4.6.01 and Earlier		
	Rule: pass vlan 100	Rule: pass ether type 0x800 0	Rule: pass vlan 100 ether type 0x080 0	Rule: pass vlan 100	Rule: pass ether type 0x800 0	Rule: pass vlan 100 ether type 0x080 0
No tags, ethertype 0800	drop	pass	drop	drop	pass	drop
One tag: TPID 8100, VID 100, ethertype 0800	pass	pass	pass	pass	pass	pass
One tag: TPID 9100, VID 100, ethertype 0800	pass	pass	pass	drop	drop	drop
One tag: TPID 88a8, VID 100, ethertype 0800	pass	pass	pass	pass	pass	pass
Two tags: outer TPID 8100 VID 100, inner TPID 8100 VID 200, ethertype 0800	pass	pass	pass	drop	drop	drop
Two tags: outer TPID 9100 VID 100, inner TPID 8100 VID 200, ethertype 0800	pass	pass	pass	drop	drop	drop
Two tags: outer TPID 88a8 VID 100, inner TPID 8100 VID 200, ethertype 0800	drop	pass	drop	drop	pass	drop
Two tags: outer TPID 8100 VID 200, inner TPID 8100 VID 100, ethertype 0800	drop	pass	drop	drop	drop	drop
Two tags: outer TPID 8100 VID 100, inner TPID 88a8 VID 100, ethertype 0800	drop	pass	drop	drop	drop	drop
Two tags: outer TPID 88a8 VID 200, inner TPID 8100 VID 100, ethertype 0800	drop	pass	drop	drop	drop	drop
Two tags: outer TPID 8100 VID 100, inner TPID 88a8 VID 100, ethertype 0800	pass	drop	drop	pass	drop	drop
Two tags: outer TPID 8100 VID 100, inner TPID 9100 VID 100, ethertype 0800	pass	drop	drop	pass	drop	drop

Priority Tagged Packets

Starting in software version 5.3, priority tagged packets are handled by the GigaVUE node. These packets have a user priority of 0 to 7 in the packet. Single tagged packets or double tagged packets with a VLAN ID of zero or a non-zero value will be sent accordingly to the tool ports.

Flow Mapping® on Inner VLAN Tags

Starting in software version 5.2, flow mapping on inner VLAN tags is supported for filtering on Q-in-Q traffic.

For packets that have both an inner and an outer VLAN tag, the outer tag is detected when the ethertype is 0x8100, 0x88A8, or 0x9100. The inner tag is detected only when the ethertype is 0x8100.

To specify an inner VLAN tag, add a new map rule (pass or drop) of type Inner VLAN.

Select a VLAN (Min) or a range of VLANs (Min and Max). Subset, even or odd, is optional.

The inner VLAN range is supported with any other qualifier with a range, such as VLAN or portsrc.

NOTE: There is no filtering after the two VLAN tags (inner and outer).

Filtering on inner VLAN uses application filter resources. To track resource usage, go to **Chassis > Quick Port Editor** for a particular box ID, card and slot.

Each map rule uses a number of entries. A single inner VLAN uses one entry per map rule. A range of inner VLANs uses two or more entries per map rule. For the same map source, identical inner VLAN or inner VLAN range spread across different rules will consume the same map rule resources.

A maximum of 454 application filter resource entries is available if no other application filters are using resources. The number of entries in the output of **Application Filter Resources** might be impacted by the other applications listed, such as GSD or Discovery.

The application filter resources are as follows:

- GSD—for GigaSMART tunnels
- Map Src—for network port source local to the node or slot (one entry per unique network port source). Note that 50 is always reserved per node or slot.
- Map Rule—for each inner VLAN rule
- Discovery—for LLDP/CDP

The following GigaVUE nodes have a maximum limit of 454 entries (the limit of 504 minus the 50 reserved):

- GigaVUE TA Series—per node
- GigaVUE-HB1—per node
- GigaVUE-HC1—per node
- GigaVUE-HC2—per node
- GigaVUE-HC3—per slot

Inner VLAN Limitation

Overlapped inner VLAN range is not supported within a map or set of maps that has the same network source. An identical VLAN range (and values) is supported.

For example, the following two rules are not supported because the inner VLAN range overlaps:

- Rule1: rule add pass inner-vlan 100 portsrc 1000
- Rule2: rule add pass inner-vlan 100..110 portsrc 1100

To overcome this, specify the rules as follows:

- Rule1: rule add pass inner-vlan 100 portsrc 1000
- Rule2: rule add pass inner-vlan 100 portsrc 1100
- Rule3: rule add pass inner-vlan 101..110 portsrc 1100

NOTE: You cannot use map rule editing to change an existing inner VLAN range to a range that overlaps with the original range. To edit an inner VLAN range, delete the rule and create a new rule with the new range.

Work with Map-Passalls and Port Mirroring in H-VUE

In addition to regular maps, H-VUE also makes it possible to create map-passall maps and configure tool-mirror ports for packet distribution.

A map-passall map lets you send all packets on a network port one or more tool ports or tool GigaStream on the same node or between the nodes in a cluster, irrespective of the packet distribution already in place for the ports.

Tool-mirror ports let you configure all a pass-all between two tool port or tool port and a too GigaStream on the same node, irrespective of the packet distribution already in place for the ports.

These map-passall maps and tool mirror ports are particularly useful in the following situations:

- Redirecting all traffic to IDS monitors regardless of any map rules applied to network ports.

- Temporary troubleshooting situations where you want to see all traffic on a port without disturbing any of the maps already in place for the port.

This section includes the following topics:

- [Syntax for Maps-passalls and Port Mirroring](#)
- [Rules for Map-Passalls and Port Mirroring](#)

Syntax for Maps-passalls and Port Mirroring

Refer to the following sections for details on map-passalls and port mirrors:

- [About Map-passall Maps](#)
- [Managing Ports](#)

Rules for Map-Passalls and Port Mirroring

Keep in mind the following rules for the map-passalls and tool mirrors:

- You can set up a map passall from:
 - Network port(s) to tool port(s) on the same node.
 - Network port(s) to one or more GigaStream.
- You can set up a tool mirror from:
 - Tool port to tool port(s) on the same node.
 - Tool port to GigaStream(s) configured with the advanced-hash algorithm on the same node.

NOTE: The destination for a map-passall or tool-mirror can be a tool port, a hybrid port, a circuit port, a tunnel, a tool GigaStream, or a hybrid GigaStream.

- You cannot set up a map-passall or tool mirror from network port to network port. To be able to create such functionality, refer to [Port Access and Map Sharing](#).
- A map-passall can cross line cards or modules – they can start on one line card/module and end on another in the same node. Also, they can cross nodes in a cluster.
- A tool mirror can cross line cards or modules – they can start on one line card or module and end on another in the same node. They cannot, however, cross nodes in a cluster.
- Tool mirrors are not allowed from tool GigaStream to tool port.
- Tool mirrors are not supported on tool ports with copper SFPs installed or on 100Gb ports with CFP2 transceivers.
- A map-passall cannot be used with a port that is part of a port-pair.

View and Delete Map-passalls

Map-passalls are created by selecting **Subtype Pass All** for a **Type Regular** map. You can view the map by clicking on the map alias on the Maps page to open the Quick View for the map. To delete a pass-all map, select the map on the Map page and click **Delete**.

Port Access and Map Sharing

There are two ways to define a user's access to ports and maps:

- Port-based access levels
- Map sharing

Both methods assign permissions to user roles, as defined by the user groups, rather than specific user accounts.

Port-based Access Levels

Users are assigned roles based on their user group. Each user group is given permission to specific ports on the node. There are four port-based permission levels:

- Level 1—Can view the port but cannot make any changes to port settings or maps. When applied to a network port, can view maps attached to the network port. This level is used for users who only need to monitor the activities of the port.
- Level 2—Can use the port for maps, create tool-mirror to/from port, and change egress port filters. Can configure port-lock, lock-share, and all traffic objects except port-pair. Also includes all Level 1 permissions.
- Level 3—Can configure port parameters (such as administrative status of the port, speed, duplex, and autonegotiation, as well as create port pairs. Also includes all Level 2 and Level 1 permissions.
- Level 4—Can change the port type. Also includes all Level 3, 2, and 1 permissions.

Table 47: Port-based Permission Levels summarized the permissions for each of the levels.

Table 47: Port-based Permission Levels

Permissions	Level 1	Level 2	Level 3	Level 4	Admin
View port	✓	✓	✓	✓	✓
View maps attached to network port	✓	✓	✓	✓	✓
Create/edit map attached to port	✗	✓	✓	✓	✓

Permissions	Level 1	Level 2	Level 3	Level 4	Admin
Create tool-mirror to/from port	x	✓	✓	✓	✓
Change egress filters	x	✓	✓	✓	✓
Edit port parameters	x	x	✓	✓	✓
Create port pairs	x	x	✓	✓	✓
Change port type	x	x	x	ü	✓

How to share Maps

Maps can be shared with one or more user groups. When sharing a map, the map owner or Admin designates which user groups have which permissions. There are four map-sharing permission levels:

- **Read Only** – Can view the map but cannot make any changes.
- **Listen** – Can add or remove tool ports they own*. This is equivalent to “subscribing” to a map.
- **Read/Write** – Can delete and edit the map, can remove any network ports, can add network ports they own*, and can add or remove tool ports they own*.
- **Read/Write/Owner** – Can perform all the Read/Write functions and assign map sharing permission levels.

***Requires Level 2 or Level 3 access, based on User Group membership.**

Table 48: [Permission Levels for Map Sharing](#), summarizes the permission levels for map sharing.

Table 48: Permission Levels for Map Sharing.

Permissions	Read Only	Listen	Read/Write	Read/Write/Owner
View map	✓	✓	✓	✓
Add tool port*	x	✓	✓	✓
Remove tool port	x	✓*	✓	✓
Remove network port	x	x	✓	✓

Permissions	Read Only	Listen	Read/Write	Read/Write/Owner
Add network port*	x	x	✓	✓
Delete/edit map	x	x	✓	✓
Share map	x	x	x	✓

***Only applies to ports to which the user has Level 2 or Level 3 access.**

NOTE: In [Table 48: Permission Levels for Map Sharing](#), tool port includes ports of type tool and inline-tool. Network port includes ports of type network and inline-network.

The admin user can also assign map sharing permissions.

Users with Level 1 (or greater) access to a given network port can also view, but not edit, maps associated with that network port. This is independent of the map sharing permissions.

Map sharing permissions override and supersede role based access controls. Thus, a user group can be assigned Read/Write access to map even if they do not have any access rights to any of the associated network or tool ports. However, adding tool ports to a map or removing network or tool ports from a map requires Level 2 or Level 3 permissions, as defined by the user group, for the ports to be added or removed.

Map Examples

This section provides the following map examples:

- [Example: How to Create a Simple Map](#)
- [Example: How to Handle Overlaps when Sending VLANs and Subnets to Different Tools](#)

Example: How to Create a Simple Map

In this example, a few simple maps are illustrated to show how to create and display the packet distribution in place on the node.

When you set up flow maps from the perspective of your tools, start by asking yourself which traffic you would like a particular tool to see. Then, select the necessary traffic from network ports.

For example, the scenario in this example is as follows:

- An application performance management tool is connected to **tool port 2/4/x6** that focuses on traffic from **VLANs 100..199** on **network ports 2/2/x10** and **2/2/x12**.

- An application performance Management tool connected to **tool port 2/4/x18** that focuses on traffic from **VLANs 200..299** on **network ports 2/2/x10** and **2/2/x12**.

The packet distribution of for this scenario is illustrated in [Figure 236: Graphical representation of Sample Maps](#).

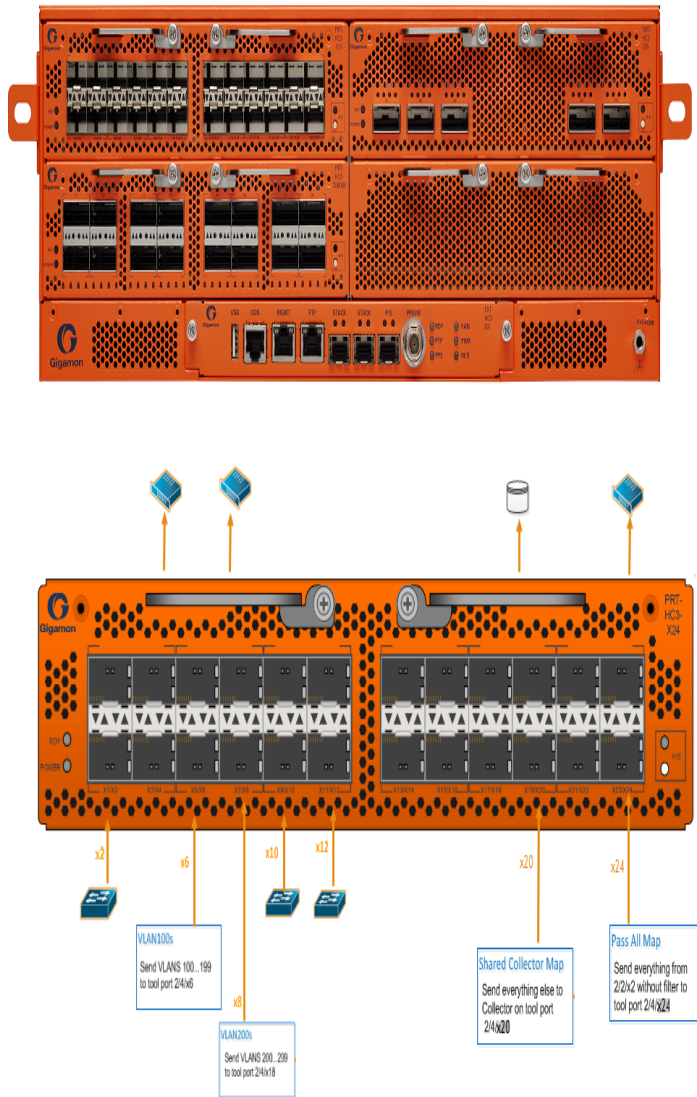


Figure 236: Graphical representation of Sample Maps

In the example shown in [Figure 236: Graphical representation of Sample Maps](#), the configuration is as follows:

- BoxID for the GigaVUE-HC3 is set as 2.
- The network ports are set on the second blade in the.
- The tool ports are set on the fourth blade in the node.

Therefore, the ports in this scenario are represented as follows:

- The network port IDs are set as 2/2/x2, 2/2/x10, and 2/2/x12.
- The tool port IDs are set as 2/4/x6, 2/4/x8, 2/2/x20, and 2/4/x24

The maps for this scenario the map types are set as follows:

- The maps with the VLAN rules specified have the subtype set as **By Rule**.
- The shared collector maps are set as subtype **Collector** and no rules added.
- The passall maps are defined as subtype **Pass All** and no rules added.

For details about the different map types, refer to [Matrix of Map Types](#) and [Map Subtypes](#).

Except for the following map types, the map type defaults to **Regular**

- Only maps with inline bypass solutions can be set as type **Inline**.
- Only maps that have GigaSMART operations defined for second level maps can be set as **First Level** or **Second Level** maps.

The following are the steps to create the simple maps as shown in [Figure 236: Graphical representation of Sample Maps](#):

1. Check the port types for the each of the ports that the maps will use and set them if necessary.
To set the port types, select Port > Ports > All Ports and use the Port Type Editor to set the port types. For more information about port types, refer to
2. Create a **Regular** map with a **By Rule** subtype to pass the VLAN100 traffic as shown in [Figure 237: Map for VLAN 100..199](#).

The screenshot displays the configuration interface for a map, organized into three main sections:

- Map Info:**
 - Map Alias: vlan100s
 - Comments: (empty)
 - Type: Regular
 - Sub Type: By Rule
 - Rule Matching: Blacklist
- Map Source and Destination:**
 - Port Editor: (button)
 - Source: 1/1/x1, 1/1/x4
 - Destination: 1/1/x2
 - GSOP: None
- Map Rules:**
 - Quick Editor, Import, Add a Rule (buttons)
 - Rule 1: Condition search... (input), Pass, Drop, Bi Directional
 - VLAN configuration:
 - Min: 100, Max: 199
 - Subset: none

Figure 237: Map for VLAN 100..199

3. Create a **Regular** map with a **By Rule** subtype to pass the VLAN200 traffic.
4. Create a map with type **Regular** and subtype **Collector** to create a shared collector map. For more information about shared collector maps, refer to [About Shared Collectors](#).
5. Create a map with type **Regular** and subtype **Pass All** to create the passall map.

Example: How to Handle Overlaps when Sending VLANs and Subnets to Different Tools

Figure 238: [Sending Subnets and VLANs to Different Ports](#) shows how to use map priority when handling packets matching criteria in multiple maps. In this example, we want to achieve the following results:

- Send packets on the 172.16.0.0 subnet to 1/2/x1
- Send packets on the 172.17.0.0 subnet to 1/2/x2
- Send packets on VLAN 100 to 1/2/x3

The trick is in how to handle packets on either 172.16.0.0 or 172.17.0.0 **and** VLAN 100. In this example, we use map priority to ensure that packets such as this are sent to both of their desired destinations.

Notice that the first two maps configured in [Figure 238: Sending Subnets and VLANs to Different Ports](#) are set up to handle this situation. For example, **map1** has a pass rule that accepts packets on 172.16.0.0 and VLAN 100. It sends matching packets to both 1/2/x1 (the destination we wanted for the 172.16 subnet) and 1/2/x3 (the destination we wanted for VLAN 100). Because this map was entered before **map3**, it has higher priority, ensuring the packet goes to both 1/2/x1 and 1/2/x3 and not just the 1/2/x3 destination specified by **map3**.

The same principle is applied in **map2** for packets on 172.17.0.0 and VLAN 100.

NOTE: If we did not observe the order of map entry shown in [Figure 238: Sending Subnets and VLANs to Different Ports](#), we could always adjust the priority as needed using the instructions in [Example: How to Create a Simple Map](#).

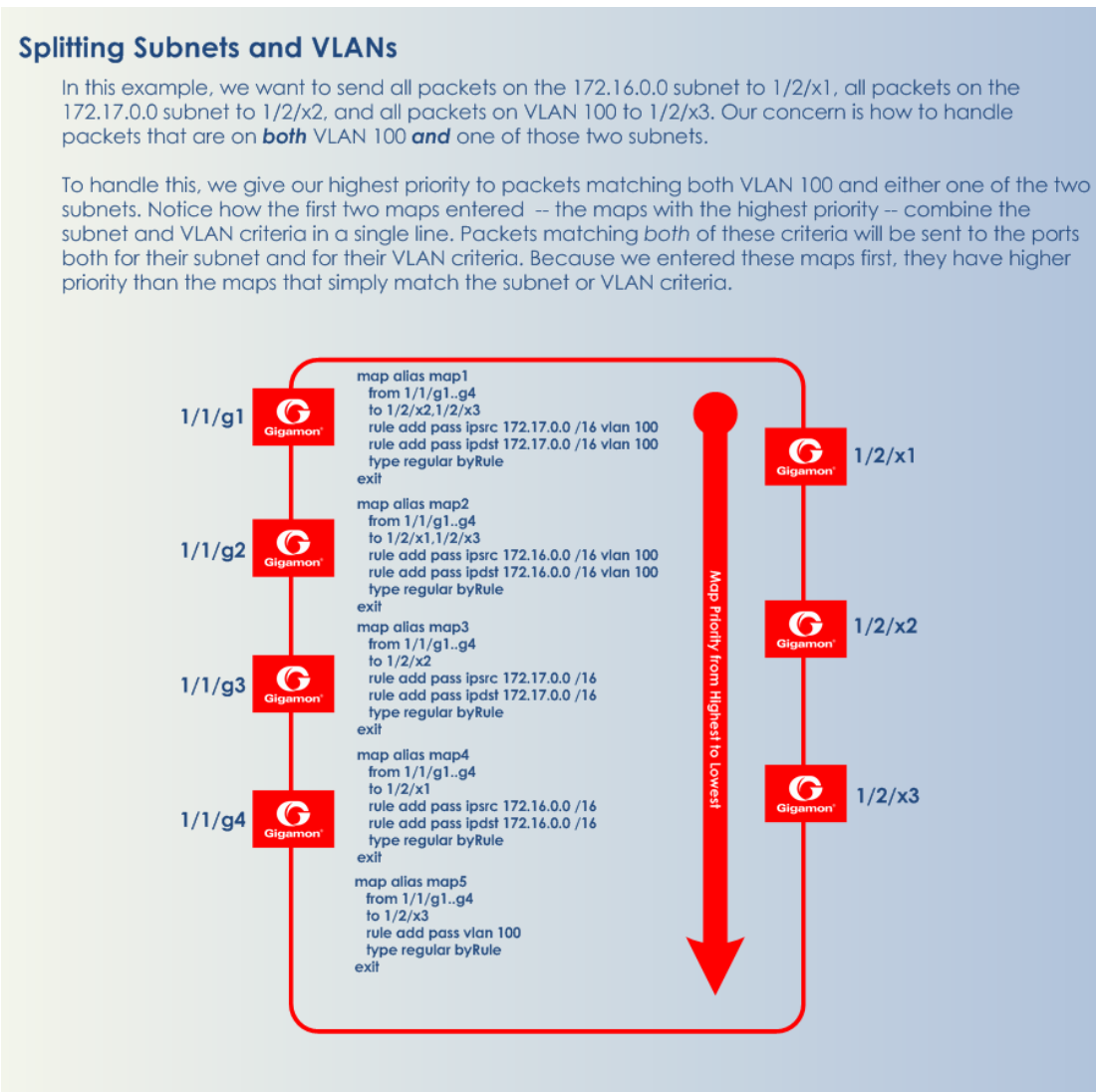


Figure 238: Sending Subnets and VLANs to Different Ports

Manage Maps

This section provides a description of the Maps pages in the H-VUE UI. It covers the following topics:

- [Map Views](#)
- [Manage Maps](#)
- [Map Templates](#)
- [Manage Map Rule Resources](#)
- [Flexible Filter Templates](#)
- [Review Map Statistics with Map Rule Counters](#)

Map Views

The Maps page displays the maps created using the CLI, H-VUE, or GigaVUE-FM APIs. The maps can be displayed in following types of views:

- [List View](#)
- [Network View](#)
- [Tool View](#)

NOTE: Starting in software version 5.5.01, any change in the map health status is indicated immediately in the Maps page.

List View

The List View is the default view of the maps when the Maps page is opened after selecting **Maps > Maps**. This view shows the basic information about each map, such as its alias, type, subtype, and source and destination ports.

Network View

The Network View displays the maps grouped by source ports then destination ports.

Tool View

The Network View displays the maps grouped by destination ports then source ports.

Manage Maps

This section provides the basic steps for doing the following tasks:

- [Map Aliases](#)
- [Create a New Map](#)

- [Clone Map](#)
- [Edit Maps](#)
- [Delete Maps](#)
- [Create Map Groups](#)

It also includes information about the following:

- [About Comments to Map Rules](#)
- [How to Use the Quick Editor for Pass and Drop Rules](#)

Map Aliases

A map alias specifies the name of the map. The alias must be unique and can contain up to 128 alphanumeric characters. Aliases are case-sensitive.

Most special characters are supported in map aliases. However, map aliases that are only one period (.) or two periods (..) should not be created. These aliases cannot be accessed for editing.

Create a New Map

The following are the steps for creating a map:

1. Check the status of the nodes and ports that you plan to use with the map.
For information about how to check the status of the nodes and ports, refer to [Status of Line Cards/Nodes and Ports](#).
2. From the device view, go to **Maps > Maps > Maps** to open the Maps page.
3. Click **New**.
4. Enter the Map Information:
 - a. Enter an alias for the map.
Use an alias that helps identify the task and destination. For example netflix_traffic_to_wireshark.
 - b. (Optional) Enter a comment about the map. When adding comments, consider the following:
 - Use up to 128 characters, including spaces.
 - Enclose the comment in quotation marks, if the comment is longer than one word.
 - To include double quotation marks (") inside the quotation marks, precede it with a backslash (\).See also [About Comments to Map Rules](#).
 - c. Select the **Type**.

The map type can be Regular, First Level, Second Level, or Inline.

For detailed information about the types of maps, refer to [Map Types](#)

- d. Select the map **Subtype**.

The map subtype can be **By Rule**, **Pass All**, or **Collector**.

For detailed information about Pass All, refer to [About Map-passall Maps](#). For detailed information about Collector, refer to [About Shared Collectors](#).

5. Specify the **Map Source and Destination**.

- a. From the **Source** and **Destination** drop-down list, select the required source and destination ports for the map. To create a port list, click **Port Editor**.

NOTE: You can add a maximum of 324 ports in the **Source** drop-down list, if the ports are not attached to a GigaStream.

NOTE: For details about port types that are supported for the different types of maps, refer to [Port Lists](#).

- b. If you have selected a circuit port in the **Destination** drop-down list, select the required circuit tunnel from the **Encapsulation Tunnel** drop-down list to encapsulate the traffic.

NOTE: For details about circuit tunnels, refer to [About Circuit-ID Tunnels](#).

- c. If the map is used to redirect the decapsulated traffic to the required tool ports, ensure that you select the IP interface in the **Source** drop-down list. You must have attached the IP interface to the VXLAN or L2GRE tunnel. For details about VXLAN or L2GRE tunnels, refer to [About Virtual Extensible LAN \(VXLAN\) Tunnels](#) and [About Layer 2 Generic Routing Encapsulation \(L2GRE\) Tunnels](#). From the **Destination** drop-down list, select the required tool ports.
- d. If the map will use a GigaSMART operation, select the operation from the **GigaSMART Operations (GSOP)** drop-down list.
- e. If you select tool GigaStream for the destination, you can view the utilization value for the GigaStream.
6. Add rules to the map.

To add rules to the map, do any of the following:

- Use the **Quick Editor**. For details, refer to the [How to Use the Quick Editor for Pass and Drop Rules](#).
- Import a map template by clicking **Import**.

- Create a rule by clicking **Add a Rule**.

For detailed information about map rules, refer to [Map Rules](#).

7. Set the **Map Order** by selecting the priority from the Priority list.

For details about map priority, refer to [Map Priority](#).

8. Set the **Map Permissions**.

For details about map permissions, refer to [Port Access and Map Sharing](#).

Clone Map

You can create a copy of an existing map by doing the following:

1. Select **Maps > Maps > Maps** to open the Maps page.
2. Select the check box of the map that you to clone.
3. Click **Clone**.
4. Make changes to the map as necessary, such as specifying an alias.
5. Click **Save**.

Edit Maps

To edit an existing map:

1. Click the List view button.
2. Select the map on the Maps page by either selecting the check box and then clicking **Edit**, or click on the row in the table and clicking **Edit** in the Map Quick View.
3. Make the changes to the map.

When editing a map, you can only modify the following:

- Map alias
- Comments
- Change the source and destination.
- Select a different GS Operation.
- Modify rules.
- Add rules.
- Delete rules.
- Permissions as allowed.

4. Click **Save**.

Delete Maps

Keep in mind the following rules and notes before you delete a map:

- If you have configured an active visibility policy action for a map, ensure that you delete the active visibility policy before you delete the map. If you delete the map before deleting the active visibility policy, it would result in errors in the policy action.
- If you delete a map, which has a network port that is shared with another map, the map statistics will be reset for the other map.

To delete a map or maps, do the following:

1. Select **Maps > Maps > Maps** to open the Maps page.
2. Select the check box for the map or maps to delete, and then Click **Delete**.
3. When the message appears, asking if you want to delete the selected maps, click **OK**.

NOTE: In the GRIP configuration, when you delete a map on the primary node, irrespective of the inline-network traffic-path, the traffic is switched to the secondary node. The port utilization must be 0% on the primary node and active on the secondary node.

Create Map Groups

Map Groups are a collection of maps that are used with GTP Flow Sampling Overlap and GTP Whitelisting Overlap GigaSMART solutions.

Use the Map Groups page to create a group of maps for GTP whitelisting and GTP flow sampling. All the maps in a map group receive traffic according to map rules, rather than map priority. Thus, multiple copies of a GTP packet can be sent to more than one tool. This functionality is referred to as overlapping maps.

The virtual port for specified as the source for GTP whitelisting and GTP flow sampling must have **GTP Overlap** enabled.

When creating Map Groups keep the following in mind:

- A map group can be associated with only one GigaSMART group (gsgroup).
- All maps within a map group must be connected to the same vport.
- A map group can consist of only one GTP whitelisting map or only one GTP flow sampling map but it cannot contains two maps of the same type.
- Once you have created a map group, you cannot edit it to change the type or subtype of the map. However, you can add or edit the map rules for a map, which is configured in a map group. Similarly, you cannot edit the map group alias but you can edit the aliases of the maps that are configured in the map group.
- If multiple map groups are configured, the maps within each map group must point to the same port groups as the other map groups.

To create a Map Group, do the following:

1. Select **Maps > Maps > Map Groups** to open the Maps page.
2. Click **New**.
3. Enter an alias for the map group.
Use an alias that helps identify the map group.
4. (Optional) Enter a comment about the map group. Refer to [About Comments to Map Rules](#) for the considerations regarding comments.
5. Click in the **Maps** field and select the maps to add to the map group.
6. Click **Save**.

About Comments to Map Rules

Use comments to label the purpose of a rule or the type of traffic covered by a rule. To add a map rule comment to a map select **Maps > Maps > Edit**.

Consider the following when adding map rule comments:

- Use up to 128 characters, including spaces.
- Enclose the comment in quotation marks, if the comment is longer than one word.
- To include double quotation marks (") inside the quotation marks, precede the quote mark with a backslash (\).

Error Messages

Error messages are displayed when a comment is invalid, for example:

- if the comment is longer than one word and does not include double quotation marks
- if the comment is longer than 128 characters
- if the rule with which the comment is included is not valid.

Edit Map Rule Comment

To edit a map rule comment, do the following:

1. Select **Maps > Maps**
2. Select the map to edit.
3. Click **Edit**.
4. Change the comments the **Comments** field
5. Click **Save** to recreate the with a different comment.

How to Use the Quick Editor for Pass and Drop Rules

When creating a map, you can use the Quick Rule Editor to quickly select custom port numbers for a map rule or add a range of IP address.

How to Use the Quick Editor to Add Port Numbers

To use the Quick Rule Editor, do the following:

1. While on an Edit Map or New Map page, click **Quick Editor** under Map Rules. This opens the **Quick Rule Editor**.
2. On the Quick Rule Editor view, select the port number or numbers to add for a pass or drop rule or both.

The Quick Rule Editor has two columns of custom port numbers, one for pass rules and one for drop rules. In each column, the ports are categorized by type. For example, **Web** provides a list of HTTP ports as shown in [Figure 239: Custom Port Number Selected in Quick Rule Editor](#), where HTTPS port 443 is selected for pass and HTTP port 80 is selected for drop.

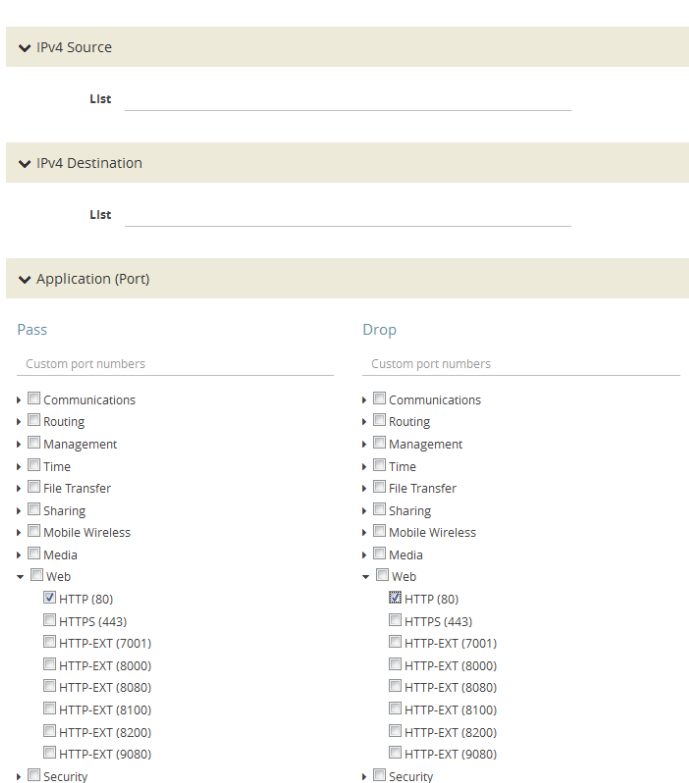


Figure 239: Custom Port Number Selected in Quick Rule Editor

3. Click **Add**.

A rule with a port source is added for each custom port number selected in the Quick Rule Editor. If the port was selected from the custom port numbers under Pass, the rule is a pass rule. If the port was selected from the port numbers under Drop, the rule is a drop rule. [Figure 240: Rules Added with the Quick Rule Editor](#) shows two rules added by the example shown in the previous step.

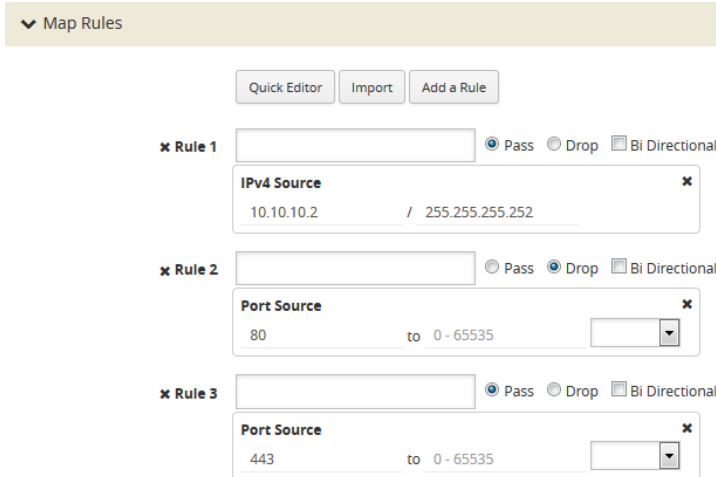


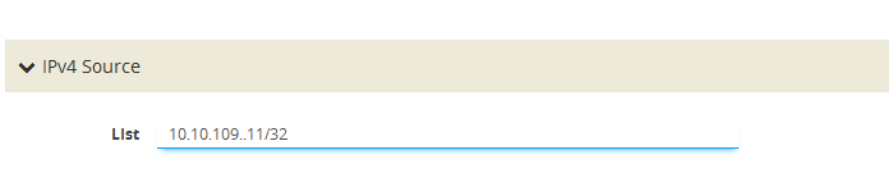
Figure 240: Rules Added with the Quick Rule Editor

How to Use the Quick Port Editor to Add IP Address

Rather than enter IP address for map rules one at a time, the Quick Rule Editor makes it possible to enter a range to quickly add the IP addresses, saving time.

To enter a range of IP address with the Quick Rule Editor, do the following:

1. While on an Edit Map or New Map page, click **Quick Editor** under Map Rules. This opens the **Quick Rule Editor**.
2. Enter an IP address range in the **List** field under IPv4 Source or IPv4 Destination or both. For example, 10.10.10.9..11/32 in the **List** field under IPv4 Source as shown in the following figure.



3. Click **Add**.

The Quick Rule Editor adds the IPv4 Source rules with the IP addresses. For example, if you entered 10.10.9..11 for the IPv4 Source, the editor adds three Ipv4 Source rules with the IP addresses 10.10.10.9/32, 10.10.10.10/32, 10.1010.11/32 as shown in the [Figure 240: Rules Added with the Quick Rule Editor](#).

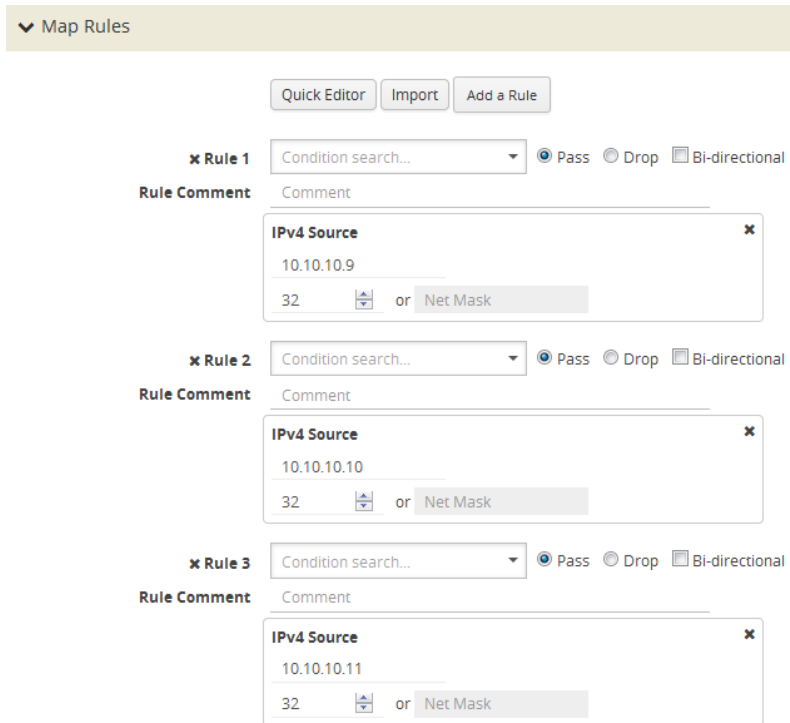


Figure 241: IPv4 Source Rules Added Through Quick Rule Editor

Map Templates

Map templates can be created by admin users. Once created, any user creating a map can use any template.

Admin users can define standardized traffic flows, applications, and rules that will be convenient for users when creating their maps. To do this, the admin creates map templates; later, users can use one or more templates as the basis for their maps.

Templates are created using the same rules and parameters as regular maps, but they do not have any network or tool ports. GigaSMART operations are also not included in templates.

The rules defined in the template become the starting point for the map. The rules can be edited or removed and new rules can be added to the map.

No changes made to the map will be reflected back in the original template. Once the map is created, it has no association with the original template from which it was created. Any changes to a template will not be reflected in any maps created with the previous version of the template.

Create Map Templates

To create a map template, do the following:

1. Select **Maps > Map Templates**.

2. Click **New**. The New Map Template opens.

Figure 242: New Map Template

3. Enter an alias in the **Map Template Alias** field.
4. (Optional) Enter comments about the template.
5. Add map rules by clicking **Add a Rule** for each rule that you want to add.
6. After you are done creating rules, click **Save**.

The new map is included on the Map Templates page.

Edit Map Templates

To edit a map template, do the following:

1. Select **Maps > Map Templates** to open the Map Templates page.
2. On the Map Template page, select the template to edit.
3. Click **Edit**.
4. Modify the map template by adding or deleting rules or comments. (You cannot change the alias.)
5. Click **Save**.

Map Template Quick View

When you click on the alias of a map template on the Map Templates page, a Quick View displays that shows the comments (if any) and rules.

Manage Map Rule Resources

The resources available on a GigaVUE H Series line card or node changes depending on the combination of criteria in place on the line card or node as a whole. In general, adding or removing MAC address, UDA pattern match, or IPv6 criteria in the map rules bound to a line card or node changes the type of filter template used on the line card or node. This can result in a brief interruption of traffic as the new template is applied.

Template Groups

The template groups are listed sequentially from least resource-intensive to most resource-intensive:

- **IPv4 Only** – This is the default filter template, including all IPv4 arguments without any MAC addresses, UDA data patterns, or IPv6 arguments. This template can support the IPv4 and related filter criteria, including VLAN tags, source/destination ports, protocol criteria, and so on.

- **IPv4 and MAC Addresses** – This template combines MAC address criteria with the standard IPv4-related criteria. When MAC address criteria are in use, map rule resources are decreased.
- **IPv4 and Single UDA Data Pattern** – This template combines one of the two available UDA data patterns with the standard IPv4-related criteria. Using a single UDA criteria does not affect the total number of drop map rules available, but it does decrease the number of pass map rules available.
- **Both UDA Data Patterns** – This template uses both UDA data patterns but removes the ipv4 argument. Drop map rule availability is not affected by adding a second UDA data pattern, but pass map rules are decreased again from what was available when only a single UDA was used.
- **IPv6 Arguments** – This template adds the use of the IPv6 argument. IPv6 criteria are resource-intensive, significantly decreasing both drop and pass map rule capacity, as shown in the following table. Note also the changes in available criteria and available resources.

The map rule criteria available in each filter template (or "group") is shown in the following table.

Table 49: Map Rule Criteria for Default Templates

Rules - Pass and Drop	IPv4	IPv4 + MAC	IPv4 + UDA	UDA	IPv6
IPv4	✓	✓	✓		
IPv6		✓			
MAC		✓			
UDA1		✓	✓		
UDA2		✓			
VLAN	✓	✓	✓	✓	✓
Inner VLAN	✓	✓	✓	✓	✓
L4 Port dst and src	✓	✓	✓	✓	✓
Ethertype		✓	✓		
IP Ver	✓	✓	✓	✓	✓
Protocol	✓	✓	✓	✓	✓
DSCP	✓	✓	✓	✓	✓

Rules - Pass and Drop	IPv4	IPv4 + MAC	IPv4 + UDA	UDA	IPv6
ToS	✓	✓	✓	✓	✓
TCP Ctl	✓	✓	✓	✓	✓
IP Frag	✓	✓	✓	✓	✓
TTL	✓	✓	✓	✓	✓
IPv6 Flow Label		✓	✓		

The number of rule entries in a cluster is shown in the following table.

Table 50: Rule Entries in a Cluster

# Rule Entries in a Cluster	IPv4	IPv4 + MAC	IPv4 + UDA	UDA	IPv6
GigaVUE-HC3	4096 (1024 per slot)	4096 (1024 per slot)	4096 (1024 per slot)	4096 (1024 per slot)	4096 (1024 per slot)
GigaVUE-HC2 CCv1 Node	4096	2048	2048	2048	2048
GigaVUE-HC2 CCv2 Node	16384	8192	8192	8192	8192
GigaVUE-HC1 Node	16384	8192	8192	8192	8192
GigaVUE-TA10/TA40 Node	2048	1024	1024	512	512
GigaVUE-TA100 Node	1024	1024	1024	1024	1024
GigaVUE-TA200 Node	1024	1024	1024	1024	1024

NOTE: In addition, you can use flexible filter templates on GigaVUE-HC3 to support up to 6K rules per slot. On GigaVUE-TA100 and GigaVUE-TA200 they support up to 6K rules per pseudo-slot, or 24K rules per node. Refer to [Flexible Filter Templates](#) for details.

Flexible Filter Templates

Flexible filter templates maximize the number of map rules, optimize filter resources, and enhance the scalability and flexibility of flow mapping. Flexible filter template is supported in GigaVUE-HC1, GigaVUE-HC2 CCv2, GigaVUE-HC3, GigaVUE-TA100, and GigaVUE-TA200.

Refer to [Manage Map Rule Resources](#) for template groups on other GigaVUE nodes.

Flexible filter templates increase the number of map rules and also eliminate current restrictions on map rule combinations, such as ipv6+MAC or ipv6+UDA.

Refer to the section [Flow Mapping® FAQ](#) for the number of map rules supported.

Flow mapping uses filter templates to determine the traffic to filter based on qualifiers specified in the template. A filter template has a specific set of qualifiers used to apply to map rules. You can control the template that you apply to a specific slot on GigaVUE-HC3 or a specific pseudo-slot on GigaVUE-TA100 or GigaVUE-TA200. For GigaVUE-HC1 and GigaVUE-HC2 CCv2, you can apply the filter template only at the control card level which will be applied across all the line cards.

Flexible filter templates offer five default templates. Custom templates can also be created that have a qualifier set selected from the list of available qualifiers.

Refer to the following sections for details:

- [Filter Template Qualifiers and Defaults](#)
- [Custom Filter Template Configuration](#)
- [Filter Template Limits](#)
- [Filter Template Rules and Recommendations](#)
- [Filter Template Best Practices](#)
- [Filter Templates in a Cluster](#)
- [Filter Templates Formulas](#)

Filter Template Qualifiers and Defaults

Refer to the rows in [Map Rule Criteria for Default Templates](#) for the list of qualifiers for filter templates. Refer to the columns in [Table 49: Map Rule Criteria for Default Templates](#) for the default templates and the qualifiers that are predefined for the defaults.

NOTES:

- The default templates cannot be deleted.
- The **ipver** qualifier is implicitly included in all default and custom templates.

Custom Filter Template Configuration

To configure filter templates:

1. Access the GigaVUE node using a Web browser and log in with administrator user credentials.
2. Select **Maps > Filter Templates**.
3. To add a custom template, click **New**.
4. Specify an alias, an optional comment, then select qualifiers. Click **OK**.

5. To apply a custom template to a slot or pseudo-slot, select it and click **Apply**.

NOTE: For GigaVUE-HC1 and GigaVUE-HC2 CCv2, you can apply a filter template only at the control card level which will be applied across all the line cards

6. Select the slot or pseudo-slot and click **OK**.

The Filter Templates page displays the applied slot or pseudo-slot. You can edit an existing custom filter or delete it. A template can be deleted if it is not currently in use, meaning that it has not been applied.

7. To display filter templates, click on a row in the Filter Templates page.

Filter Template Limits

The number of qualifiers in a template limits the total number of rules that can be defined. The maximum rule limit on the GigaVUE-HC3, GigaVUE-TA100, or GigaVUE-TA200 is 1K (1024) per slot or pseudo-slot when using the default templates.

Custom templates allow the creation of templates with only those qualifiers needed for the rules that you plan to use in flow maps. The qualifiers specified in a flexible template can increase or decrease the maximum rule limit, depending on the qualifiers selected. With flexible filter templates, it is possible to reach a maximum limit of 6K rules per slot on the GigaVUE-HC3 node and 6K rules per pseudo-slot on the GigaVUE-TA100 or GigaVUE-TA200 node, or 24K total rules.

[Flexible Filter Templates](#) displays a Limit.

How to Understand Map Filter Resources

Starting in software version 5.0, when a filter template is applied, filter resources display the total number of map rules used in a map as well as the limit. If the limit is 1024, 1023 is displayed, even though the actual limit is 1022, or two less than the limit. This discrepancy is due to extra resources needed for internal usage.

Filter Template Rules and Recommendations

When creating flexible filter templates, keep the following rules and recommendations in mind:

- Filters are applied to a specific slot or pseudo-slot, not to the node.
- By default, all slots will be in the pre-defined **ipv4** template.
- There is a limit of 512 custom templates.
- Custom templates can have duplicate sets of qualifiers.

- The filter limit is calculated when the template is created. In most cases, a higher-cost qualifier set (for example, IPv6, UDA, or MAC are higher cost) consumes more resources and leads to a lower filter limit.
- Flexible filter templates have no effect on existing flow mapping behavior, including pass versus drop map rules, map priority, network port sharing, GigaSMART operations, or first level and second level maps.

Filter Template Best Practices

The following are best practices for optimizing filter resources using filter templates.

First determine all the needed qualifiers, then create a template, apply the template, and configure the map rules.

- Connect network ports of a slot to flows of the same application.
For example, if you have two flows:
 - one is filtered on **macsrc** and **macdst**
 - the second one is filtered on **ipdst** and **ipsrc**
- In case both flows connect to ports on the same slot, that slot will have to have a template of **macsrc**, **macdst**, **ipsrc**, and **ipdst**, with a limit of 1024 rules.
- However, filter resources can be optimized by connecting these two flows to ports on different slots with one template for **macsrc** and **macdst** and the other template for **ipsrc** and **ipdst**. Both templates will have a limit of 3072 rules.

The following are best practices for adding more rules if a limit has been reached:

- Create a new template with all the qualifiers that are in use on a specified slot.
- Issue the **show filter-resource slot** command to obtain the list of qualifiers in use.
- Issue the **filter-template alias <alias> qualifiers add** command with that list of qualifiers.
- Issue the **show filter-template limit** command to check if the new template allows a higher limit. If it does, apply the filter using the **card slot <slot ID> filter-template** command.

Filter Templates in a Cluster

Filter template configuration is synchronized across the cluster. However, a cluster can have different GigaVUE nodes, so one set of qualifiers may or may not be valid on all nodes.

Filter Templates Formulas

The formulas in this section can help you determine the number of map rules that are supported, based on the qualifiers specified in the filter template. Use the formulas as guidelines.

The number of map rules depends on the number of qualifiers a template can support. The total cost of qualifiers for a map rule must not exceed 10.

The cost of each qualifier depends on the number of bits it consumes. The following table lists the number of bits each qualifier consumes and the cost for each qualifier.

Table 51: Bits Consumed and Cost per Qualifier

Qualifier	Bits	Cost
dscp	6	1
ethertype	16	1
ip6src	128	4
ip6dst	128	4
ip4src	32	1
ip4dst	32	1
macdst	48	2
macsrc	48	2
macsrc and macdst	96	3
portsrc	16	1
portdst	16	1
protocol	8	1
tos	8	1
ttl	8	1
vlan	16	1
vxlan	48	1
l2gre	24	1
uda1	128	4
uda2	128	4
inner-vlan	16	1
qset1*	58*	*

* qset1 is made up of the following: tos: 8, ipfrag: 2, tcpctl: 8, ttl: 8, ip6fl: 32. The cost depends on the combination of the qualifiers used.

The qualifier cost is the cost of all qualifiers + 54 bits.

- If the cost is less than or equal to 80 bits, 6K rules/slot are supported.
- If the cost is greater than 80 bits but less than 160 bits, 3K rules/slot are supported.
- If the cost is greater than or equal to 160 bits, 1K rules/slot are supported.

Examples:

- For the ip6src and vlan qualifiers—ip6src is 128 bits, vlan is 16 bits, so the total is 128+16+54 bits, which is a cost greater than 160 bits, so 1K rules per slot are supported.
- For the portdst qualifier only—portdst is 16 bits, so the total is 16+54 bits, which is a cost less than 80 bits, so 6K rules per slot are supported.

The maximum cost supported is 480 bits/template.

Review Map Statistics with Map Rule Counters

Map Statistics can be viewed in the following ways:

- The Statistics page.
For details, refer to [Viewing Map Statistics with the Statistics Page](#)
- The Map Quick View.
For details, refer to [Viewing Map Statistics with Quick View](#)

A single packet may match multiple rules in the map and will not cause multiple rule counters to increment. Only the last rule which is the highest priority in the order will increment. The flow map rule priority is based on the order it was created. Thus, the sum of the map rule counters across all the map rules may be higher than the total number of packets received and transmitted by the map.

NOTE: Drop rules have a higher priority than pass rules.

For example, consider the following three map rules:

- **Rule 1** – ipsrc 10.10.0.0 /24 bidir
- **Rule 2** – ipsrc 10.10.0.100 /32 bidir
- **Rule 3** – portsrc 80

A packet with ipsrc 10.10.0.100 and portsrc 20 will match Rule 1 and Rule 2, which will be forwarded to the tool port or ports. The counters for Rule 2 will only be incremented.

There are several reasons a map rule counter may not increment:

- Traffic matching the rule is not currently present in the production network.

- The network port is not monitoring the network at the proper location to see the traffic specified by the map.
- A higher-priority map is forwarding the packet before it can be inspected by this particular map.
- The map rule itself may be specified incorrectly.

Viewing Map Statistics with the Statistics Page

To review map statistics indicating the total packets and total octets handled by maps and the number of rules in the map, select **Maps > Maps > Statistics**. The Statistics page displays the map statistics in a table format listing the maps by their alias. Clicking on a map alias opens a Quick View for that map. To clear map counters, click the **Clear** button.

Viewing Map Statistics with Quick View

To review map rule counters indicating the number of rule matches for a map as packets are inspected and forwarded, select the map and view the information in the Quick View window.

Flow Mapping® FAQ

This section answers frequently asked questions by users migrating to the Flow Mapping® model.

How Many Map Rules are Supported?

The maximum number of map rules supported per line card or standalone node are shown in [Maximum Number of Nodes and Map Rules Supported in a Cluster](#).

Table 52: Maximum Map Rules

Node Type	Maximum Combined Rules	Maximum with Flexible Filter Templates	Maximum with Advanced Features License
GigaVUE-HC2	4K (4096)	N/A	N/A
GigaVUE-HC2 with Control Card version 2 (HC2 CCv2)	16K (16383)	16K (16383)	N/A

Node Type	Maximum Combined Rules	Maximum with Flexible Filter Templates	Maximum with Advanced Features License
GigaVUE-HC3 Node GigaVUE-HC3 Module	4K (4096) 1K (1024)	24K (24576) 6K (6144)	N/A
GigaVUE-HC1	16K (16383)	16K (16383)	N/A
GigaVUE TA Series	256	The Flexible Filter Templates are available only for GigaVUE-TA100 and GigaVUE-TA200 nodes.	The Advanced Features License is available only for the GigaVUE-TA Series. The extended max rule limit varies based on the GigaVUE-TA Series node.
GigaVUE-TA10	256	N/A	2K (2048)
GigaVUE-TA40	256	N/A	4K (4096)
GigaVUE-TA100	256	256	6K (6144) per pseudo-slot with Flexible Filter Template and Advanced Feature License. 1K (1024) per pseudo-slot with only Advanced Feature License.
GigaVUE-TA100-CXP	1K (1024)	N/A	N/A
GigaVUE-TA200	256	256	6K (6144) per pseudo-slot with Flexible Filter Template and Advanced Feature License. 1K (1024) per pseudo-slot with only Advanced Feature License.

The limit for GigaVUE TA Series standalone nodes is 256 combined pass/drop rules but is up to 2048 with the Advanced Features License installed.

Refer to [Manage Map Rule Resources](#) for managing map rules.

The maximum number of nodes and map rules supported when in a cluster is as follows:

Table 53: Maximum Number of Nodes and Map Rules Supported in a Cluster

When a Cluster is Configured with:	Number of Nodes	Maximum Map Rules
Out-of-Band Cluster Management	32	38000
Inband Cluster Management	16	38000

The maximum number of map rules supported in a cluster apply to all nodes in the cluster including GigaVUE H Series nodes: GigaVUE-HC3, GigaVUE-HC2, GigaVUE-HC1, and GigaVUE-HB1, and GigaVUE TA Series nodes: GigaVUE-TA1, GigaVUE-TA40, and GigaVUE-TA100, including Certified Traffic Aggregation White Box (white box).

How Many Rules Can Each Map Have?

The maximum number of rules per map is 4K (4096), except on products that only support a total of 2K map rules. GigaVUE-HC3 supports 6K rules per map. Refer to [Maximum Number of Nodes and Map Rules Supported in a Cluster](#).

How Many Maps Can Run at Once?

The maximum number of maps that can run is only limited by the total number of rules used by the maps.

What Criteria can be Filtered in Q-in-Q Packets?

Maps on GigaVUE nodes can match Layer 3/Layer 4 criteria in packets using Q-in-Q with up to two tags. For more information refer to [How to Handle Q-in-Q Packets in Maps](#).

Which Line Card Do Map Rules Count Against?

The limits for map rules are based on the locations of the network ports for the map and count equally against each line card in GigaVUE HD Series nodes with ports in the map. For example, a map with 500 pass rules provisioned against ports 1/4/x2 and 1/5/x8 counts as 500 rules against the maximum available for the line card in both slot 1/4 and 1/5.

For optimal allocation of map rules, maps using different sets of multiple network ports should keep those sets on different line cards, modules, or nodes. However, this is not a requirement.

Example

Consider the following scenario:

- Line card in slot 2/8 already has 1600 pass rules allocated.
- Attempting to provision a map consisting of 500 pass rules on network ports 1/1/x1 and 2/8/x9 will result in an error message stating that the map cannot be created.
- Reconfiguring the map to use network ports 1/1/x1 and 1/1/x2 (instead of 1/1/x1 and 2/8/x9) prevents this exposure and allows the map to be created.

How Many Maps Can Share a Network Port?

There is no limit to the number of maps that can share a network port.

How Many Network Ports and Tool Ports Can Be in a Map?

If the ports are not in a GigaStream, the number of individual map ports in the **Source** or **Destination** field of a map is limited to 64 on all GigaVUE H Series nodes. The individual ports can be any of the following port types: network or tool.

On GigaVUE-HC2 and GigaVUE-HC3, if the ports are in a GigaStream, the limit is 95.

Are Port-Filters Supported?

Yes.

Egress port-filters, are less efficient and scalable than flow maps, but they do provide a convenient way to narrow down the traffic seen by the tools/GigaVUE H Series nodes without having to change an entire map. Refer to [Port Filters](#) for details.

Each GigaVUE-HC2 or GigaVUE-HC3 module, or GigaVUE-HB1 node supports 100 combined egress port-filters. A single filter applied to multiple tool ports counts multiple times against the 100-filter limit.

In the GigaVUE-HC2 equipped with Control Card Version 2 (HC2 CCv2), or the GigaVUE-HC1 or GigaVUE-HC3 node, the limit is 400 filters.

The GigaVUE TA Series can only support 20 egress port-filters. When the GigaVUE-TA100 or GigaVUE-TA200 are in a cluster, they can support 400 filters.

Does Flow Mapping® Support Passalls?

Yes.

Flow Mapping® supports passalls with the following:

- The map **Subtype Pass All** option for network to tool port passalls.
- A tool-mirror connection between to tool ports. The Tool Mirrors page replaces the tool-to-tool port passalls. To create a Tool Mirror, select **Ports > Tool Mirrors** to go to the Tool Mirror page shown in [Figure 243: Tool Mirror Page](#).

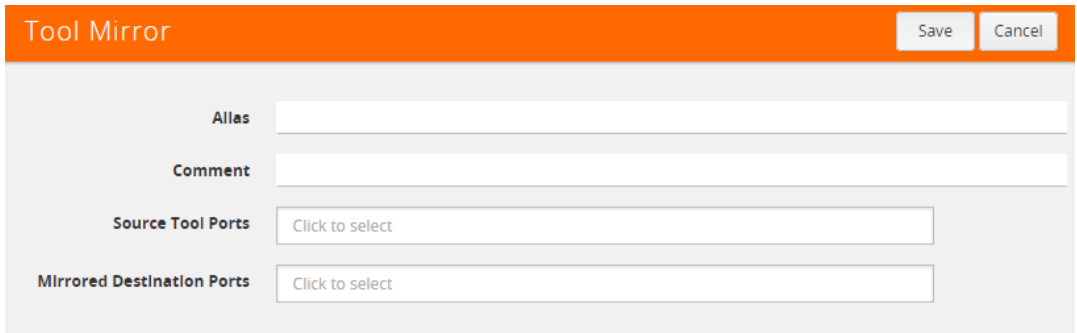


Figure 243: Tool Mirror Page

Does Flow Mapping® Support port-pairs?

Yes.

Select **Ports > Port Pairs** to go to the Port Pairs page shown in [Figure 244: Creating Port Pairs](#). For more information about port pairs and details on configuring two ports as an inline TAP, refer to [Port Pairs](#).

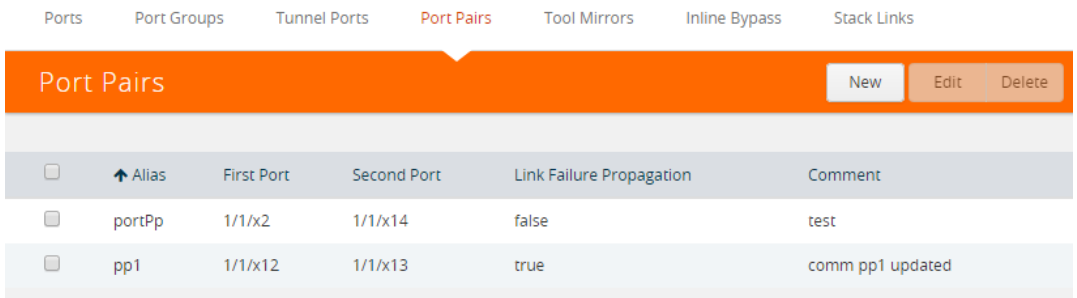


Figure 244: Creating Port Pairs

Does Flow Mapping® Support UDA Pattern Matches?

Yes.

Pattern match rules are still supported in map rules. However, they can only be used in pass rules. UDA pattern matches are not supported in drop rules. Refer to [Work with User-Defined Pattern Match Rules](#) for details.

Are Maps Supported Across Nodes in a Cluster?

Yes.

Clusters of GigaVUE nodes operate as a unified fabric. Use the standard box ID/slot ID/port ID syntax to create packet distribution, just as on a standalone node. Maps can have network ports and tool ports on different physical nodes within the cluster.

Similarly, a map does not need to keep its network and tool ports on the same physical node in order to take advantage of GigaSMART operations – a GigaVUE TA Series node in a cluster can take advantage of the GigaSMART processing available on a GigaVUE-HC2 or GigaVUE-HC3 module, or GigaVUE-HC1 or GigaVUE-HB1 node elsewhere in the same cluster.

Does Flow Mapping® Support GigaSMART Operations?

Yes.

The wizards in H-VUE make it easier than ever to include GigaSMART operations – rather than having to create a GigaSMART operation separately before including it in a map, you can now create and use it all within the same mapping wizard. Refer also to [Work with GigaSMART Operations](#) for examples of flow mapping.

Can a GigaStream Act as a Shared Collector?

Yes.

Multiple individual ports for a Shared Collector can be setup on a GigaStream tool group. Refer to [About Shared Collectors](#) for details.

What Are the GigaStream Maximums?

The number of GigaStream per line card, module, or node varies by product. Refer to [GigaStream Rules and Maximums](#) for the details.

Does H-VUE Provide the Same Features as the GigaVUE-OS CLI?

The H-VUE provides all of the mapping features of the CLI in an intuitive and highly-usable setting. The map creation wizard speeds map creation.

Configure Active Visibility

This section describes active visibility. Refer to the following sections for details:

- [Overview of Active Visibility](#)
- [Configure Active Visibility](#)

Overview of Active Visibility

Active visibility is a framework that allows your visibility network to adapt to dynamic events. The framework is designed to react to events and take actions in response to events in your visibility network.

An active visibility policy defines conditions and actions. When conditions are met, actions are executed. The policy specifies both the conditions and the actions and ties them together.

The conditions and actions are pre-defined. Conditions are events that are used to trigger changes to configuration. Actions can notify users of certain events and/or modify the configuration in response to certain events. Conditions can be port-based or time-based.

For example, if a tool port is overloaded, you might want to reduce the traffic sent to the tool. You can configure two maps, one targeted for your high priority traffic and the other targeted for your low priority traffic. Then you can specify conditions to monitor tool port utilization. When traffic is below a threshold, both maps can be enabled, thus all traffic will be sent to the tools. But when traffic is above the threshold, you can specify an action so that only the map targeted for the high priority traffic is enabled and thus only that traffic will be sent to the tool.

Another example is that you might want to use a different set of maps and map rules to provide visibility during different times, such as during working hours, or on weekends. If there is going to be a backup on the weekend, you can specify a policy to disable a map at a specific time or day.

NOTE: GigaVUE-FM GUI for Active Visibility is available only until software version 5.4.00. Refer to the "Configuring Active Visibility" section in the *GigaVUE-OS-CLI Reference Guide* for details on further software enhancements of this feature.

Configure Active Visibility

Refer to the following sections for details:

- [Display Conditions](#)
- [Display Actions](#)
- [Configure Policies](#)

Display Conditions

Go to **Active Visibility** > **Conditions** to display the pre-defined conditions, their description, and comment.

Display Actions

Go to **Active Visibility > Actions** to display the pre-defined actions, their description, and comment.

Configure Policies

An active visibility policy defines conditions and actions. When all conditions are met, all actions are executed. The policy ties the conditions and actions together.

A policy must have at least one condition. An action is not required.

Up to five (5) conditions can be specified in a policy. The parameters and values that are specified in the condition depends on the condition. The policy is executed only when all conditions are met.

Within a policy, there is one unique condition. For example, there can only be one **PortUp** condition, not multiple **PortUp** conditions within a policy.

Up to five (5) actions can be specified in a policy. The parameters and values that are specified in the action depends on the action.

Within a policy, there can be multiple actions, including the same action. For example, there can be multiple **PortEnable** actions within a policy.

A policy is triggered if all the conditions are met. Then all the actions are executed. If there are five conditions in the policy, they all have to be met before the action or actions are executed. If there are multiple actions, they are executed in sequence, as specified in the policy. The policy specifies the priority of the actions.

When there are multiple actions, they will continue to be executed even if there is an error. For example, if there are three actions and there is an error with the second action, the first and third actions will be executed. When the policy executes, each action will have their status reported (success or failure).

Multiple policies can be in effect at the same time. The policies can monitor different conditions and take different actions. Up to 100 policies per cluster can be defined.

A policy must be enabled for it to become active. However, when you first create a policy, you might want to disable it so that it does not become active right away.

When a policy is triggered, an SNMP event and email notification (policytrigger) can optionally be generated.

An active visibility policy defines conditions and actions. When all conditions are met, all actions are executed. The policy ties the conditions and actions together.

1. Go to **Active Visibility > Policies** to start configuring a policy.
2. Click **New**.
3. The Policy page has sections for Policy Info, Conditions, and Actions.
4. Enter an alias for the policy and a description, if desired. When you first define a policy, you will probably want the policy to be disabled, so clear the Enable checkbox.
5. Select a condition from the drop-down menu. The parameters and values that are populated for each condition depend on the condition. For example, in [Figure 245: Conditions on Policy Page](#), the condition is PortTxUtilLow, so there is an Any checkbox and fields for Port ID, Threshold (%), and Period (seconds). For details on configuring conditions, refer to [Configure Conditions](#).

Conditions

Port Tx Util Low

Any ⓘ

Port ID * ⓘ

Threshold(%) * ⓘ

Period (seconds) ⓘ

Figure 245: Conditions on Policy Page

6. Select or type the parameters and values for each condition. Refer to [Figure 246: Conditions on Policy Page, Entered](#).

Conditions

Port Tx Util Low

Any ⓘ

Port ID * ⓘ

Threshold(%) * ⓘ

Period (seconds) ⓘ

Figure 246: Conditions on Policy Page, Entered

7. For multiple conditions (up to five), click + or -.

8. Select an action from the drop-down menu. The parameters and values that are populated for each action depend on the action. For example, in [Figure 247: Actions on Policy Page](#), the action is Port Disable, so there is a Porting checkbox and a field for Port ID. For details on configuring actions, refer to [Configure Actions](#).

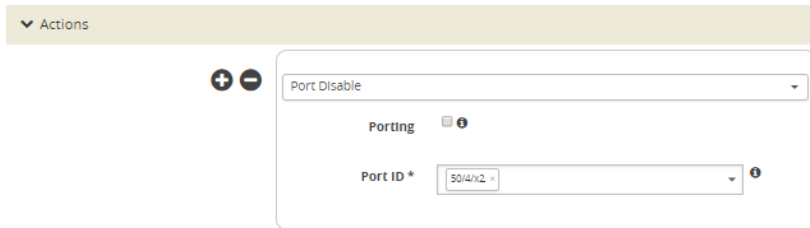


Figure 247: Actions on Policy Page

9. For multiple actions (up to five), click + or -.
10. When you have specified the conditions and actions, click **OK**.
11. The newly defined policy is displayed.
12. When you are ready to enable a policy, select the policy, click **Edit**, select the Enable checkbox, and click **OK**.
13. Another way to enable a policy is to select the policy, click **Actions**, and select Enable.
14. When a policy has not been executed, it will show a status of NOT EXECUTED. When a policy has been executed, it will show a status of SUCCESS or FAILURE.
15. To view information on a policy that has executed, click **Report History**. The policy report history is displayed.
16. To edit a policy, select a policy and click **Edit**.
17. The Policy Info, Conditions, and Actions are displayed.
18. Make the changes and click **OK**.
19. To clone a policy, select a policy and click **Clone**.
20. Change the policy alias, make any changes to conditions or actions, and click **OK**.
21. To delete a policy, select a policy and click **Delete**.
22. A confirmation displays. To confirm, click **OK**.
23. To view details of a policy, click a policy in the Policies page.
24. To edit the policy, click **Edit** or to exit, click **X**.

Configure Conditions

The parameters and values that are populated for each condition depend on the condition. Refer to the following sections for details:

- [Configure Port Up/Port Down Conditions](#)
- [Configure Port Rx/TxConditions](#)
- [Configure Time Conditions](#)
- [Configure Time of Day Conditions](#)

Configure Port Up/Port Down Conditions

To configure port up and port down conditions:

1. Select Port Up or Port Down. Refer to [Figure 248: Port Up or Port Down Conditions](#).

The screenshot shows a configuration panel for 'Port Down' conditions. It includes a dropdown menu for 'Port Down', an 'Any' checkbox, a 'Port ID *' dropdown menu with 'Select a Port' selected, and a 'Period (seconds)' field with '1 - 7200' selected. There are plus and minus icons on the left and information icons on the right of the fields.

Figure 248: Port Up or Port Down Conditions

25. Specify the following:

- Any—Click if any of the selected ports match the condition.
- Port ID—Select one or more ports to match the condition.
- Period—Specify the number of seconds to wait for the condition to be true, in integers from 1 to 7200.

Configure Port Rx/TxConditions

To configure port Rx/Tx conditions:

1. Select Port Rx or Port Tx conditions. Refer to [Figure 249: Port Rx or Tx Conditions](#).

The screenshot shows a configuration panel for 'Port Rx Buffer High' conditions. It includes a dropdown menu for 'Port Rx Buffer High', an 'Any' checkbox, a 'Port ID *' dropdown menu with '1/1/rx4' and '1/1/rx6' selected, a 'Threshold(%) *' field with '0 - 100' selected, and a 'Period (seconds)' field with '120' selected. There are plus and minus icons on the left and information icons on the right of the fields.

Figure 249: Port Rx or Tx Conditions

2. Specify the following:

- Any—Click if any of the selected ports match the condition.

- Port ID—Select one or more ports to match the condition.
- Threshold—Specify the threshold as a percentage from 0 to 100% for Port Rx/Tx Buffer and Util, or as a value between 0 and 2^{64} , for example, 1024, for Port Rx/Tx Errors, Drops, and Discards.
- Period—Specify the number of seconds to wait for the condition to be true, in integers from 1 to 7200.

Configure Time Conditions

To configure Time conditions, select a Time condition. Refer to [Figure 250: Time Conditions](#).



Figure 250: Time Conditions

Configure Time of Day Conditions

To configure time of day conditions:

1. Select Time Of Day. Refer to [Figure 251: Time of Day Conditions](#).

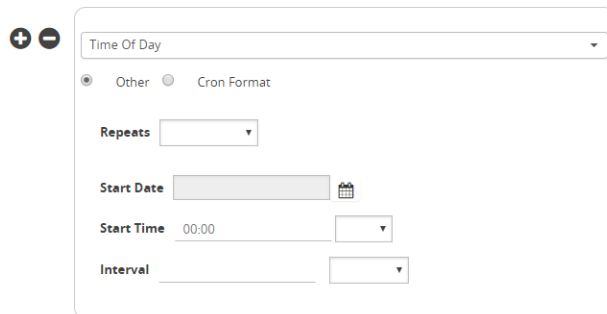


Figure 251: Time of Day Conditions

2. Click Cron Format. Refer to [Figure 252: Time of Day Conditions, Cron Format](#).

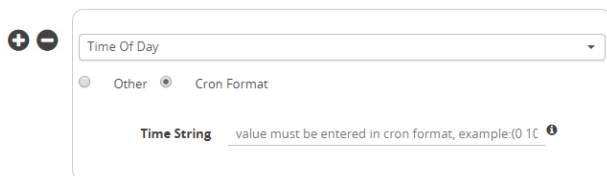


Figure 252: Time of Day Conditions, Cron Format

3. Enter the value in Cron format. For more information on Cron, refer to: <http://www.nncron.ru/help/EN/working/cron-format.htm>
4. Or, click Other. Refer to [Figure 253: Time of Day Conditions, Other Format](#).

Figure 253: Time of Day Conditions, Other Format

5. The Other format allows you to specify the following:

- Repeats—Specify Once Only, or a recurrence of Minute, Hourly, Daily, Weekly, Monthly, or Yearly.
- Start Date—Specify the Start Date using the calendar.
- Start Time—Specify the Start Time in hours and minutes, then select AM or PM.
- Interval—For repeat occurrences, specify the interval. For occurrences longer than Hourly, specify the interval as Minute, Hour, or Day.
- Every—For occurrences longer than Hourly, specify the number of days, weeks, or months. For example, if Repeats is Daily, Every can be every 2 days.
- End Date—For occurrences longer than Hourly, specify an end date that is After a specified number of occurrences or By a date specified using the calendar. The default is None.
- On—For Weekly repeats, specify the day of the week. For Monthly repeats, specify the First, Second, Third, Fourth, or Last day of the month, or specify the day of the month as a number from 1 to 31. The default is None.

Configure Actions

The parameters and values that are populated for each action depend on the action. Refer to the following sections for details:

- [Configure Port Actions](#)
- [Configure Policy Actions](#)
- [Configure Map Actions](#)
- [Configure Map Rule Add Actions](#)
- [Configure Map Rule Delete Actions](#)

Configure Port Actions

To configure port actions:

- 1 Select Port Disable or Port Enable. Refer to [Figure 254: Port Actions](#).

Port Disable

Porting

Port ID * 1/1/x2,1/1/x4

Figure 254: Port Actions

6. Specify the following:
 - Porting—Select if you want to pass the port, defined in a condition, to the action.
 - Port ID—Select one or more ports to match the action.

Configure Policy Actions

To configure policy actions:

- 1 Select Policy Disable or Policy Enable. Refer to [Figure 255: Policy Actions](#).

Policy Enable

Policy Alias * pol1

Figure 255: Policy Actions

7. Select a policy alias.

Configure Map Actions

To configure map actions:

- 1 Select Map Disable or Map Enable. Refer to [Figure 256: Map Actions](#).

Map Enable

Map Alias * td_map_1

Figure 256: Map Actions

8. Select a map alias.

Configure Map Rule Add Actions

To configure map rule add actions:

- 1 Select Map Rule Add. Refer to [Figure 257: Map Rule Add Actions](#).

Figure 257: Map Rule Add Actions

9. Specify the following:

- Map Alias—Select a map alias.
- Add a Rule—Click to add one or more map rules.
- Rule String—Specify a map rule, such as pass VLAN 100. The parameters and values that are populated for each rule depend on the rule.

Configure Map Rule Delete Actions

To configure map rule delete actions:

1 Select Map Rule Delete. Refer to [Figure 258: Map Rule Delete Actions](#).

Figure 258: Map Rule Delete Actions

10. Specify the following:

- Map Alias—Select a map alias.
- Rule ID—Specify a map rule ID.

GigaSECURE Security Delivery Platform

This section is an overview of the GigaSECURE[®] Security Delivery Platform (SDP), which transforms the way security applications are deployed and leveraged, enabling them to be more effective at protection and remediation, less complex, and more cost-effective. This section also provides links to detailed information for the pillars of GigaSECURE and to other documents.

GigaSECURE solutions provide pervasive visibility of network traffic, user, application, and suspicious activity, which bolsters security effectiveness, eliminates blind spots, and enables protection against threats. With GigaSECURE, you look inside networks to detect where compromise has occurred.

Figure 259: GigaSECURE Security Delivery Platform displays the pillars of the Security Delivery Platform along the bottom of the figure, consisting of GigaVUE Visibility Platform nodes (H Series and TA Series, as well as standalone and embedded TAPs) with GigaVUE-VM providing access to virtual traffic, and applications for NetFlow/IPFIX Generation, SSL Decryption, and Application Session Filtering (ASF), as well as inline bypass.

On the right of Figure 259: GigaSECURE Security Delivery Platform, the Application Programming Interface (API) enables a degree of automation, allowing security tools to control the traffic feeds they receive from the SDP.

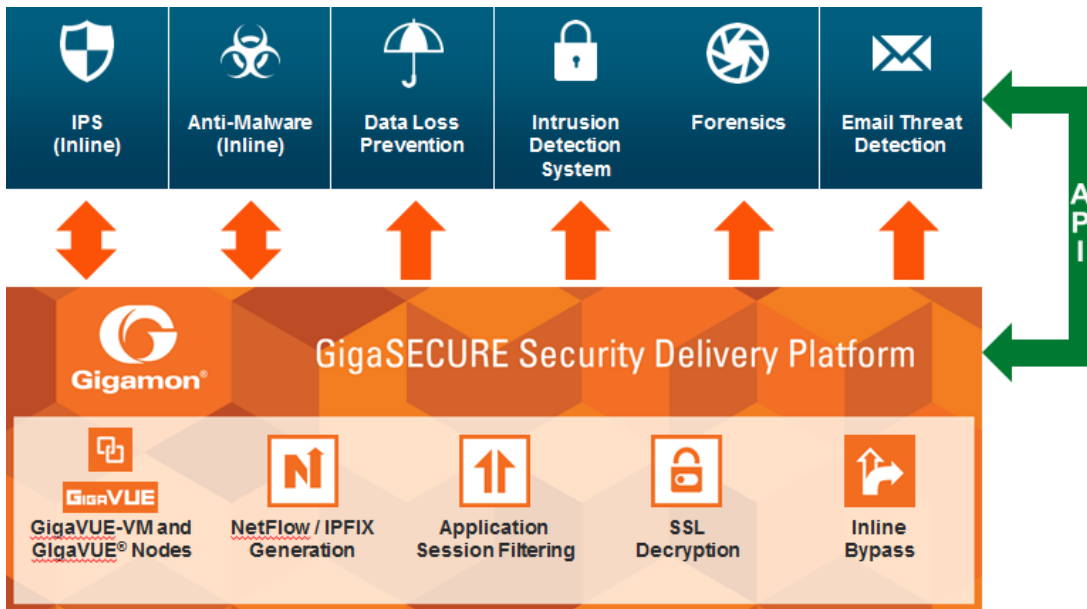


Figure 259: GigaSECURE Security Delivery Platform

GigaSECURE SDP connects into the network, across physical and virtual infrastructures, and delivers traffic to the applications that require it. Security tools connect into the SDP at whatever interface speeds they are capable of connecting. Consequently, they will receive a relevant traffic stream from across the network infrastructure.

Through SDP, organizations can unify their security applications (displayed along the top of Figure 259: GigaSECURE Security Delivery Platform), eliminating blind spots and partial coverage. Security devices can get a complete view of the network flows and the metadata that they require in order to detect threats or network compromise.

GigaSECURE Security Delivery Platform provides the following:

- a complete network-wide reach, physical and virtual. Refer to [GigaSECURE and GigaVUE nodes, TAPs, GigaVUE-VM and FM](#).
- scalable metadata extraction for improved forensics. Refer to [NetFlow Generation](#) under [GigaSECURE and GigaSMART Applications](#).
- isolation of applications for targeting inspection. Refer to [Application Session Filtering](#) under [GigaSECURE and GigaSMART Applications](#).
- visibility to encrypted traffic for threat detection. Refer to [SSL Decryption](#) under [GigaSECURE and GigaSMART Applications](#).
- inline bypass for connected security applications. Refer to [GigaSECURE and Inline Bypass](#).

GigaSECURE and GigaVUE nodes, TAPs, GigaVUE-VM and FM

To provide complete, network-wide reach, GigaSECURE consists of Visibility Platform nodes running GigaVUE-OS software, a virtualized node (GigaVUE-VM), and a centralized fabric controller (GigaVUE-FM). Traffic visibility is delivered from physical and virtual environments even when users, devices, and applications move around.

Refer to the following sections:

- [GigaVUE H Series and TA Series Nodes and TAPs](#)
- [GigaVUE-VM](#)
- [GigaVUE-FM and APIs](#)

GigaVUE H Series and TA Series Nodes and TAPs

GigaVUE H Series and TA Series are Visibility Platform nodes with the ability to cluster multiple nodes. Features include traffic aggregation, intelligent filtering, and the ability to replicate traffic to multiple security tools without performance impacts.

The GigaVUE TA Series provide a cost-effective way to provide scale-out traffic visibility. These nodes provide aggregation, filtering, and replication capabilities at a cost-effective price. This enables traffic from across the infrastructure to be channeled back to selective security tools.

Standalone TAPs or embedded TAPs are also available to TAP network traffic from 10Mb to 100Gb links.

GigaVUE H Series, TA Series, and Certified Traffic Aggregation White Boxes all run GigaVUE-OS software.

The GigaVUE H Series products are described in the following documents: *GigaVUE-HC3 Hardware Installation Guide*, *GigaVUE-HC2 Hardware Installation Guide*, *GigaVUE-HC1 Hardware Installation Guide*, and *GigaVUE HB Series Hardware Installation Guide*.

The GigaVUE TA Series products are described in *GigaVUE TA Series Hardware Installation Guide*.

The Certified Traffic Aggregation White Box is described in *GigaVUE-OS Installation Guide on a White Box*.

TAPs are described in *G-TAP M Series Hardware Guide*.

GigaVUE-VM

GigaVUE-VM is a virtualized node that provides the ability to deliver traffic visibility into virtualized workloads. This enables a physical security tool to extend the security function to virtual traffic.

GigaVUE-VM also provides the ability to track virtual machines as they move from server to server, and enforce Follow-the-VM policies to ensure that application traffic is always sent to the security tools even if the VMs move.

GigaVUE-VM is described in the *GigaVUE Cloud Suite for VMware Configuration Guide*.

GigaVUE-FM and APIs

GigaVUE-FM serves as the centralized controller that provides the ability to unify the different components of the GigaSECURE Security Delivery Platform. It serves as a centralized policy definition point for the virtualized and physical Visibility Platform nodes.

GigaVUE-FM exposes a set of northbound APIs that allow security solutions to fine-tune in near real-time the traffic feeds that they are receiving, so as to adjust their visibility into the network infrastructure based on what real-time anomalies, threats, and conditions they are seeing.

GigaVUE-FM APIs are described in *GigaVUE-FM REST API Reference in GigaVUE-FM User's Guide*.

GigaSECURE and GigaSMART Applications

The GigaSMART applications in the GigaSECURE[®] Security Delivery Platform provide the ability to act on traffic streams and perform a series of functions that serve to offload and optimize a variety of security solutions.

The three GigaSMART applications in the GigaSECURE Security Delivery Platform are NetFlow Generation, SSL Decryption, and Application Session Filtering (ASF).

NetFlow Generation

NetFlow generates detailed flow and session intelligence based on actual traffic, not just a sample of traffic.

IPFIX is a powerful standards-based technology that is gaining momentum in the network security space for forensics, trend analysis, and anomaly detection. IPFIX looks at raw network packets and derives sophisticated flow-based metadata such as records of conversations between endpoints, duration of conversations, and channels of communications.

GigaSECURE centralizes the function of generating these flow records so that this can be done consistently across heterogeneous and disparate infrastructure. The flow records can be served up to a variety of security solutions that analyze flow metadata. The flow metadata generation is done at very high throughput so as to generate high-fidelity records that are essential for good security analytics.

The solution also enables custom templates to be defined so that the information that can be gleaned from the traffic can be highly tailored to the specific deployment environment.

The GigaSECURE Security Delivery Platform with NetFlow Generation:

- provides unsampled NetFlow/IPFIX record generation to detect "low-and-slow" attacks
- filters records based on configurable parameters to predetermined tools
- offloads NetFlow/IPFIX record generation from the overloaded network infrastructure
- enables end-to-end security enforcement with visibility into every flow
- provides advanced information elements

NetFlow Generation is described in this document. Refer to [GigaSMART NetFlow Generation](#) for details.

Application Session Filtering

Application Session Filtering (ASF) with or without buffering provides the ability to deliver just the relevant traffic streams to the specific types of security tools. For example, an email security solution need not see YouTube traffic. Sending only relevant traffic allows the security solutions to function more effectively and waste less bandwidth and resources processing irrelevant information.

Many security solutions do not need to look at entire flows that are either trusted or that they have no ability to process. ASF provides the ability to look deep into the packet at the application layer, identify application flows based on patterns within the packets, and steer entire sessions to a specific security solution (for example, all packets belonging to a session, even if subsequent or preceding packets for that session do not match the pattern) or to discard the entire session.

This powerful capability allows precise control of the types of traffic data that are sent to security tools based on Layer 4 to Layer 7 and more sophisticated content matching, thereby ensuring that security solutions are focused on working off network traffic that is most relevant to them while simultaneously offloading those tools from having to process large volumes of irrelevant data.

Application Session Filtering is described in this document. Refer to [GigaSMART Application Session Filtering \(ASF\) and Buffer ASF](#) for details.

Also refer to the *Application Session Filtering Cook Book*.

SSL Decryption

There are two SSL Decryption applications as follows:

- [Out-of-Band SSL Decryption](#)
- [Inline SSL Decryption](#)

Out-of-Band SSL Decryption

SSL decryption for out-of-band tools provides a solution to decrypt encrypted communications so that security tools can detect malware that leverages encrypted communication channels and ensures that sensitive information is not compromised.

As the volume of malware that leverages encrypted communication channels increases, the need to peek into those encrypted channels of communication increases. Decrypting those encrypted channels of communication is best done within the GigaSECURE Security Delivery Platform so that this is done once, at very high performance thereby eliminating this blind spot simultaneously for multiple security tools that do not have the ability to deal with encrypted communications. For those security tools that have the ability to do this, it offloads a computationally intensive task from being repetitively done in each security tool.

Out-of-band SSL decryption delivers decrypted traffic to out-of-band tools that can then detect threats entering the network. When a threat is detected, the tools can send a notification.

Out-of-band SSL decryption is described in this document. Refer to [GigaSMART Out-of-Band SSL Decryption](#) for details.

Inline SSL Decryption

SSL decryption for inline tools provides visibility into encrypted traffic. Inline SSL decryption delivers decrypted packets to tools that can be placed inline or out-of-band. The tools look into decrypted packets for threats, such as viruses or other malware.

The amount of Internet traffic that is encrypted is increasing, and much of it is encrypted with Secure Sockets Layer (SSL) and Transport Layer Security (TLS) protocols.

Malware increasingly uses encrypted SSL traffic, thus a significant percentage of attacks hide in SSL. Inline SSL decryption delivers a complete view of encrypted applications and hidden threats in your organization.

Many applications, such as email, also use SSL. Encryption protects data from being viewed in transit over the Internet such as in an exchange of emails. Encryption also keeps the data private. But when data is encrypted, packets are not inspected, which can create blind spots in your network.

Providing visibility into encrypted traffic eliminates this blind spot. SSL/TLS blind spots in your network can be eliminated across any port or application, for example, port 443, or email, Web, or VoIP applications.

Inline SSL decryption inspects SSL encrypted traffic inline. The advantage of this solution is that when SSL decryption is inline, tools can act when a threat is detected.

Inline SSL decryption is described in [Inline SSL Decryption](#).

GigaSECURE and Inline Bypass

Inline bypass in the GigaSECURE[®] Security Delivery Platform supports inline and out-of-band network security deployments from the same platform. It provides the ability to load balance both inline and out-of-band security tools as well as to bypass inline security tools in the event of failure.

Many security tools work inline with the network traffic to prevent malware and malicious activities in real-time. Many other security tools work out-of-band for detection and incident generation purposes. The GigaSECURE Security Delivery Platform provides a common platform to serve traffic feeds to both inline and out-of-band security deployments.

When serving inline security deployments, the GigaSECURE platform provides the ability to load balance traffic across multiple inline security solutions, as well as the ability to guide traffic serially to different inline security tools, each providing different levels of protection. Traffic can be distributed to the security tools based on a variety of criteria, while ensuring that forward and reverse traffic for a given flow always goes to the same security tool.

The platform also provides resiliency and protection in the event that any of the inline security tools experiences a failure, both in load balanced mode as well as when inline tools are connected in a serial fashion, thereby ensuring that network traffic forwarding is not disrupted in the event of a failure.

Security tools can also be moved from out-of-band to inline and vice versa with no disruption to the network.

The GigaSECURE Security Delivery Platform with inline bypass:

- maximizes tool efficacy
- increases scale of security monitoring
- provides seamless add, remove, and upgrade of tools
- consolidates multiple points of failure into a single, bypass-protected solution
- integrates inline, out-of-band, and flow-based tools

Inline bypass is described in this document. Refer to [Configure Inline Bypass Solutions](#) for details.

Flexible Inline Arrangements

This chapter provides an overview about the flexible inline arrangements, the supported platforms and software versions, the supported and unsupported functionalities, and limitations. It also provides details about how to configure the flexible inline maps and how to visualize the flexible inline arrangements canvas.

IMPORTANT: It is recommended to define inline configurations through GigaVUE-FM.

- If you configure a flexible inline arrangement solution using the GigaVUE-OS CLI, you cannot view or manage it using GigaVUE-FM.
- If you modify a flexible inline arrangement solution using the GigaVUE-OS CLI, you cannot view the changes in GigaVUE-FM.

NOTE: If your nodes and GigaVUE-FM instance are running software version 5.6.xx or earlier, ensure that you add all the nodes to GigaVUE-FM, upgrade the GigaVUE-FM to 5.8.xx, and then upgrade the nodes to 5.8.xx. This is to ensure that the flexible inline maps added to the nodes before the upgrade are visible in the canvas in GigaVUE-FM. Refer to the GigaVUE-OS Upgrade guide for details.

Refer to the following sections for details:

- [About Flexible Inline Arrangements](#)
- [Benefits of Flexible Inline Arrangements](#)
- [About Flexible Inline Maps](#)
- [Flexible Inline Arrangements—Rules and Notes](#)
- [Visualize the Flexible Inline Arrangements Canvas](#)

- [Configure Flexible Inline Flows](#)
- [Troubleshoot Flexible Inline Flows](#)
- [Backup and Restore Flexible Inline Flows](#)

About Flexible Inline Arrangements

Flexible inline arrangements is an approach to guide multiple inline traffic flows through a user-defined sequence of inline tools and inline tool groups. It uses the same software constructs as the existing inline bypass solution, such as inline network, inline tool, and inline tool group. Flexible inline arrangements support physical protection based on the specialized hardware on BPS modules. It also supports both protected and unprotected inline network links.

Flexible inline arrangements offers an alternative to classic inline bypass. Classic inline bypass functionality remains intact for backwards compatibility. For information on configuring inline bypass solutions (classic), refer to [Inline Bypass Solutions](#).

Using flexible inline maps, traffic from the same inline network can traverse different sequences of inline tools and share tools across traffic flows or with other inline networks.

You can identify specific flows of traffic using Layer 2 to Layer 4 rules, then designate the tools that will inspect the traffic, and specify the order of the tools. For example, you can send Web traffic (defined by L4 port, 80 and/or 443) through a Web Application Firewall (WAF) and an Intrusion Prevention System (IPS), have backup traffic that might bypass inspection, and send all other traffic through the same IPS.

Figure 260: Flexible Inline Arrangements Scenario illustrates a complex inspection scenario that is enabled by flexible inline arrangements.

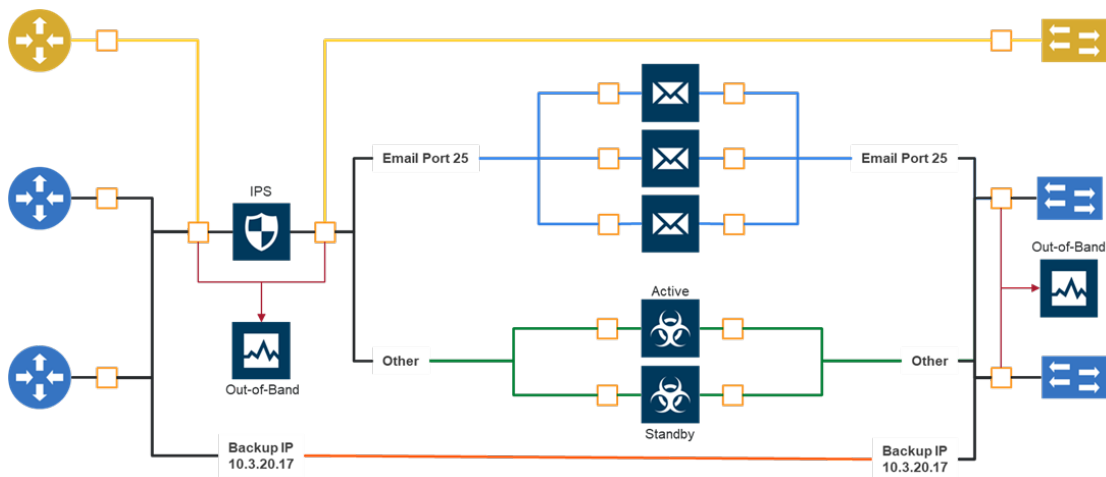


Figure 260: Flexible Inline Arrangements Scenario

In this example, on the left, there are three network links, all of which share the IPS. The details are as follows:

- At the top of the figure, the yellow line represents a flow of network traffic that only needs IPS inspection.
- In the middle of the figure, the Email and Other traffic represents network traffic flows that go through IPS inspection first, then the Email traffic goes to dedicated inspection tools, here shown as three tools in an inline tool group, and the Other traffic goes to a threat protection active/standby pair.
- At the bottom of the figure, daily Backups of already-inspected traffic goes to bypass.

Although not shown graphically in [Figure 260: Flexible Inline Arrangements Scenario](#), the traffic in the reverse direction can have a different order of tools than the west-east traffic.

Supported Platforms

Flexible inline arrangements are supported on all GigaVUE HC Series nodes:

- GigaVUE-HC1
- GigaVUE-HC2 (CCv1 and CCv2)
- GigaVUE-HC3

The inline networks, inline tools, and inline tool groups involved in the flexible inline maps must be on the same node.

Software Version

GigaVUE-FM and GigaVUE-OS running on software version 5.3.xx or higher support the flexible inline arrangement functionality.

GRIP Supported by Flexible Inline Arrangements

Gigamon Resiliency for Inline Protection (GRIP™) is an inline bypass solution that connects two GigaVUE nodes together so that one node provides high availability to the other node when there is a loss of power. This redundant arrangement of two GigaVUE nodes maintains traffic monitoring by inline tools when one of the nodes is down. Flexible inline arrangements support GRIP.

Functionalities Not Supported by Flexible Inline Arrangement

Certain functionality is not supported by flexible inline arrangements. In the following cases, use classic inline bypass instead:

- for inline tools that cannot tolerate the addition of VLAN tags to the traffic
- for asymmetrical hashing to an inline tool group in which one direction to hash is based on source IP address and the other direction to hash is based on destination IP address

Benefits of Flexible Inline Arrangements

Flexible inline arrangements offer flexibility in how traffic is guided through inline tools. It has the following benefits compared to classic inline bypass:

- Guides traffic through any arbitrary sequence of inspection tools.
- Shares inline tools across multiple inline network links and across multiple inline maps.
- Distributes traffic across multiple tools to meet bandwidth and throughput demands.

Flexible inline arrangements use the same software constructs as the classic inline bypass solution, such as inline network, inline tool, and inline tool group. However, inline network group and inline serial constructs are not needed.

Inline network groups have changed with flexible inline arrangements. Now every inline network is independent and can share any combination of tools in any order. The concept of inline network group is supported by creating multiple flexible inline maps. Also, multiple inline networks can be grouped into an inline network bundle. You can configure one inline map for the network bundle with the inline network bundle as the source.

Inline serial is not needed because the flexibility offered with flexible inline arrangements allows for the same configuration without the inline serial construct.

[Figure 260: Flexible Inline Arrangements Scenario](#) illustrates the benefits of flexible inline arrangements by showing the kinds of deployment scenarios that can be enabled with this approach.

About Flexible Inline Maps

Traffic flows are the building blocks of flexible inline arrangements. Flows can be based on any flow mapping criteria, such as TCP port, IP subnet, or VLAN. There is a one-to-one correspondence between a traffic flow and a flexible inline map.

A flexible inline map is a new map type. Flexible inline arrangements allow inline maps from inline networks to arbitrary sequences of shared (overlapping) sequences of inline tools and inline tool groups.

Using flexible inline maps, you can identify specific flows of traffic using Layer 2 (L2) to Layer 4 (L4) rules, then designate the tools that will inspect the traffic, and specify the order of traffic to the tools.

You can configure a flexible inline map with a specific inline tool that is part of an inline tool group, which is associated with another flexible inline map. For example, you have created an inline tool group, ITG1 in which inline tools, IT1, IT2, and IT3 are grouped together. You can configure a flexible inline map, Map1 with inline network, IN1 as the source and ITG1 as the destination. You can configure a second flexible inline map, Map2 with IN1 as source and IT1 as destination. Such configuration is useful to guide specific traffic to a particular inline tool and the rest of the traffic to the inline tool group in which the inline tool is associated.

To properly guide traffic through the inline tools, each flow of traffic is assigned a VLAN tag. VLAN tags can be automatically assigned or can be user-defined. You can use flexible inline single tags to map incoming VLANs on the network side to the outgoing VLANs on the tool side.

With flexible inline arrangements, VLAN tags are associated with each inline map, not with each inline network port as in the case of classic inline bypass. A single inline network port can have multiple inline maps, each with a separate VLAN tag.

For example, traffic flows can be defined with the following VLAN tags:

- Unspecified traffic—VLAN 101
- Web traffic—VLAN 102
- Email traffic—VLAN 103
- Database traffic—VLAN 104

NOTE: The VLAN tags are added to the traffic before it is sent to the tools and are removed before it is sent back to the network.

Types of Flexible Inline Maps

To define a traffic flow, you must configure a flexible inline map. Following are the two types of flexible inline maps:

- **byRule**—Use the byRule map type to define a flow using map rules. Any standard L2-L4 mapping rules can be specified in the map, such as, IPv4, IPv6, L4 port, or UDA.
- **collector**—Use the collector map type for all other traffic. A collector is the lowest priority of map and does not have a map rule definition. Use a collector to catch any traffic that does not

go to any other map. You can define a flexible inline collector map without any other maps in place. This provides a map passall, provided there are no rule-based maps. If you want all the traffic to go to the same tools, you only need to configure a collector.

Flexible inline arrangements guide rule-based or collector-based inline traffic flows through unidirectional or bidirectional sequences of inline tools or inline tool groups. The traffic path can be set up independently for side A to side B and side B to side A directions, meaning that the traffic flow can be either symmetrical or asymmetrical.

You specify the ordered list of inline tools or inline tool groups that will inspect a particular flow of traffic. Additionally, you can specify if the A-to-B and B-to-A directions have the same order or the reverse order. Reverse order is the order of inline tools as they are wired in a physical network if a Gigamon network packet broker was not present.

For example, in the A-to-B direction, if the tools are specified in the following order: T1, T2, T3, the same order in the B-to-A direction will be: T1, T2, T3, while the reverse order in the B-to-A direction will be: T3, T2, T1. Or, you can specify the order of the tools explicitly, for example, the B-to-A direction can be: T2, T1, T3.

You can create separate flexible inline maps for each flow of traffic to be inspected by a sequence of inline tools. Create maps until you have accounted for all the flows of traffic. Any unspecified traffic will go to the collector. You can also specify map priorities for the flexible inline maps.

Configure Flexible Inline Maps

Before you configure a flexible inline map, ensure that you create the required inline network. For information, refer to [Configure Inline Network Ports and Inline Network](#).

To configure a flexible inline map:

1. Go to **Physical > Inline Flows**, and then click **Configuration Canvas** to create a new Flexible Inline Canvas.
2. In the Flexible Inline Canvas that is displayed, select the required device for which you want to configure the flexible inline map.
3. Drag and drop the required inline network into the Flexible Inline Canvas.
4. Drag and drop the Flex Map into the Flexible Inline Canvas.
5. In the **Properties** pane that appears, enter a name and description for the map in the **Alias** and **Comment** fields.
6. Enter the required **Tool Side VLAN Tag**.

7. Add the required rules for the inline map. You can also choose to import an existing map template. For instructions on how to create a map template, refer to [Create Map Templates](#).
8. Click **OK** to save the configuration.

Flexible Inline Arrangements—Rules and Notes

Keep in mind the following when working with flexible inline arrangement:

- If an inline tool is associated with a flexible inline map, it cannot be used in a classic inline map or in an inline decryption map. All inline networks and inline tools must participate exclusively in either flexible inline maps or classic inline maps.

Visualize the Flexible Inline Arrangements Canvas

The GigaVUE-FM user interface provides clear visualization of inline maps. The user interface makes it easy to visualize and configure inline maps and tools. The drag-and-drop capability lets you define and add tools to maps, in any order. Refer to [Figure 261: Flexible Inline Flow - Canvas](#).

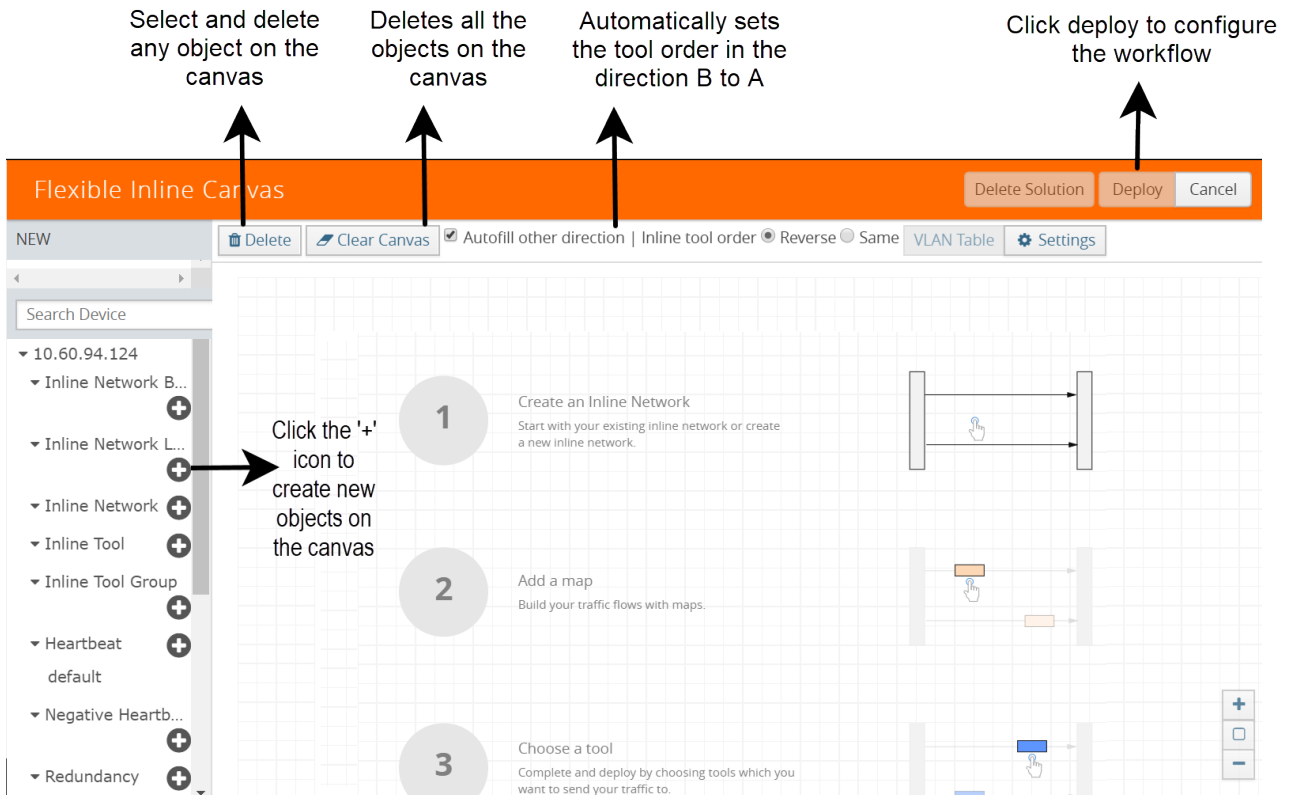


Figure 261: Flexible Inline Flow - Canvas

Configure Flexible Inline Flows

This section describes about the different flexible inline flows and provides step-by-step instructions on how to configure them using GigaVUE-FM. It also provides information about the forwarding states of the inline network.

Refer to the following sections for details:

- [Configure Inline Network Ports and Inline Network](#)
- [Configure Inline Network Link Aggregation Group \(LAG\)](#)
- [Configure Inline Network Bundle](#)
- [Configure Inline Tool Ports and Inline Tools](#)
- [Configure Inline Tool Group](#)
- [Configure Inline Single Tag](#)
- [Configure Resilient Inline Arrangement](#)
- [Configure Flexible Inline Decryption Solution](#)
- [View the Forwarding States of Inline Networks](#)

Configure Inline Network Ports and Inline Network

An inline network consists of inline network ports, always in pairs, running at the same speed, on the same medium (either fiber or copper). The inline network ports must be on the same GigaVUE-HC series node.

Following are the two types of inline network:

- **Unprotected inline network**—It is an arrangement of two ports of the inline network type. The arrangement facilitates access to a bidirectional link between two networks (two far-end network devices) that need to be linked through an inline tool.
- **Protected inline network**—It is implemented using bypass combo modules. It is based on the pairs of ports associated with physical protection switches on the bypass combo modules. For a protected inline network, the ports are created automatically when the bypass combo modules are recognized by the GigaVUE HC Series node.

To configure inline network ports and an inline network:

1. Go to **Physical > Inline Flows**, and then click **Configuration Canvas** to create a new Flexible Inline Canvas.
2. In the Flexible Inline Canvas that is displayed, select the required device for which you want to configure the inline network.

- Click the '+' icon next to the **Inline Network** option to create a new inline network. Refer to [Figure 262: Inline Network Configuration](#).

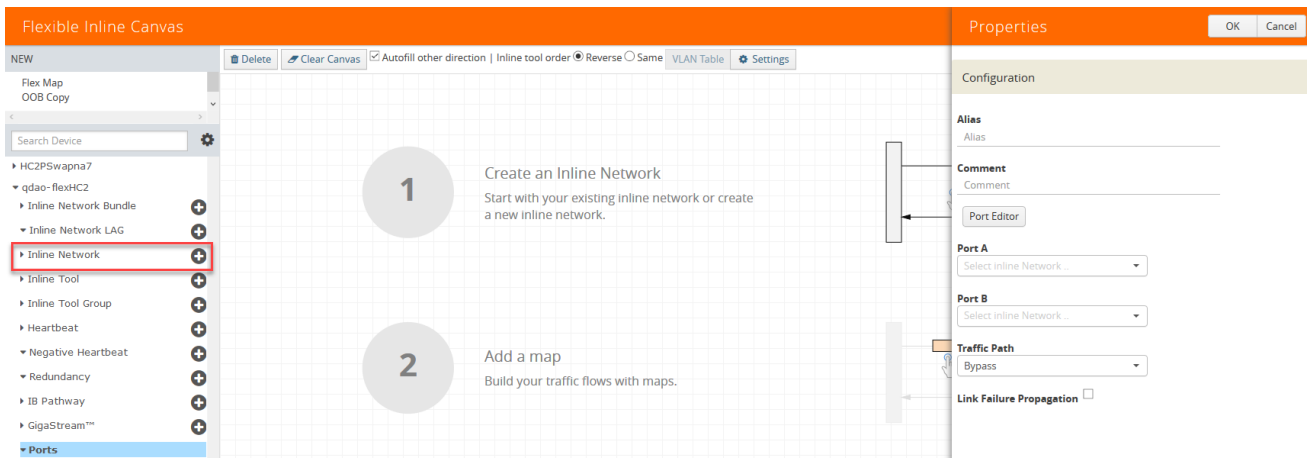


Figure 262: Inline Network Configuration

- In the **Alias** and **Comment** fields, enter a name and description for the inline network, and then click **Port Editor**.
- In the **Quick Port Editor**, scroll down to the inline network ports that you wish to configure. Select **Enable** to administratively enable inline network ports, and then click **OK**.
- From the **Port A** and **Port B** drop-down lists, select the ports that you want to configure as the inline network pair.
- From the **Traffic Path** drop-down list, select one of the following options:
 - Bypass**—all traffic that originates from the inline network bypasses the sequence of inline tools and inline tool groups and is redirected to the opposite-side inline network port.
 - Drop**—all traffic originating from the inline network is dropped.
 - Bypass with Monitoring**—a copy of the traffic originating from the inline network bypasses the sequence of inline tools and inline tool groups and is redirected to the opposite-side inline network port. Another copy of the traffic is directed to the sequence of inline tools and inline tool groups, except that no traffic of the second copy is sent to the exit port.
 - To Inline Tool**—all traffic originating from the inline network is directed to the sequence of inline tools and inline tool groups and is guided through the inline tools and inline tool groups according to the current inline tool and inline tool group status.
- Click **OK** to save the configuration.
- Drag the **Inline Network** object to the canvas and click **Deploy**. Refer [Figure 263: Inline Network Deployed](#)

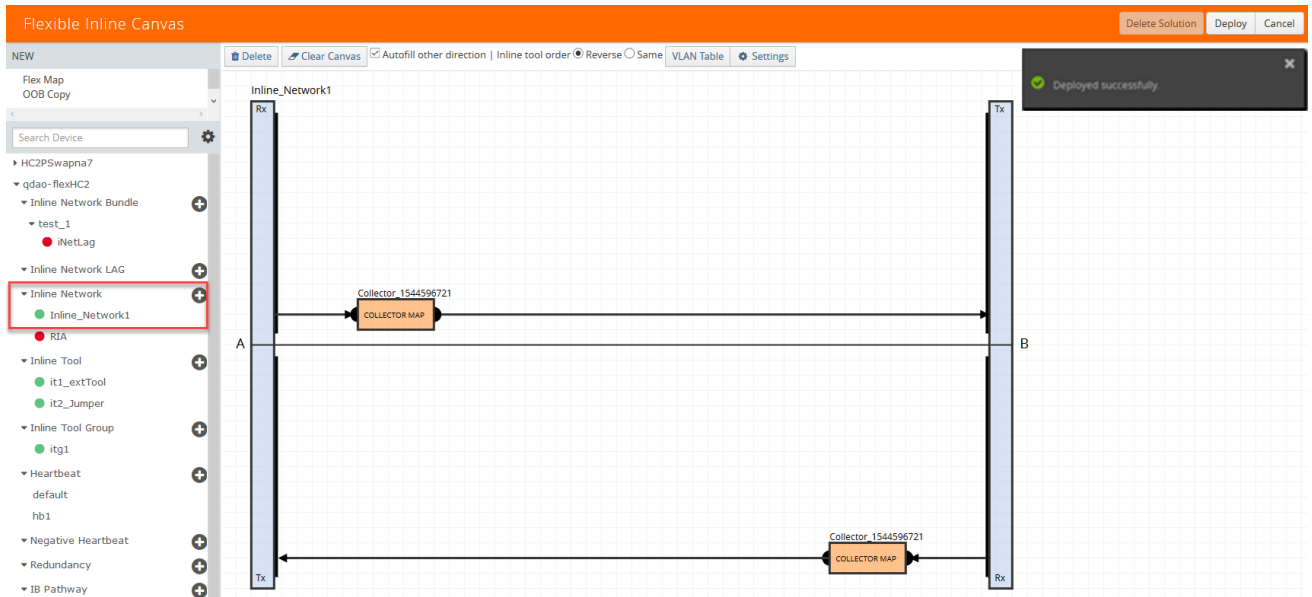


Figure 263: Inline Network Deployed

Configure Inline Network Link Aggregation Group (LAG)

Refer to the following sections that provide details about the inline network LAG, its limitations, and instructions on how to configure the inline network LAG:

- [About Inline Network LAG](#)
- [Inline Network LAG—Rules and Notes](#)
- [Configure Inline Network LAG](#)

About Inline Network LAG

A Link Aggregation Group (LAG) is a method of combining a number of physical ports together to make a single high-bandwidth data path, and thereby implement the traffic load sharing among the member ports in the group and to enhance the connection reliability. If you have a LAG in your network that must be inspected inline, the Flexible inline network LAG feature allows you to group the inline networks as one logical entity, instead of creating separate inline networks for each link in the LAG. Moreover, you can configure a flexible inline map with the inline network LAG as the source.

Traffic from the inline network LAG is grouped and sent to the inline tools with the same VLAN ID. The return traffic from the inline tools is hashed to the other side of the inline network LAG so that the incoming and the outgoing inline networks are different.

Each inline networks in an inline network LAG has their own specific forwarding states and traffic path settings. When one member link in the LAG goes down, the traffic is sent to the other member links.

Inline Network LAG—Rules and Notes

Keep in mind the following when working with inline network LAG:

- You cannot combine protected and unprotected inline networks, or inline networks with different speed in an inline network LAG.

Configure Inline Network LAG

Before you configure an inline network LAG, ensure that you configure the required inline network ports and inline networks. Refer to [Configure Inline Network Ports and Inline Network](#).

To configure an inline network LAG:

1. Go to **Physical > Inline Flows**, and then click **Configuration Canvas** to create a new Flexible Inline Canvas.
2. In the **Flexible Inline Canvas** that is displayed, select the required device for which you want to configure the inline network LAG.
3. Click the '+' icon next to the **Inline Network LAG** option to create a new inline network LAG. Refer [Figure 264: Inline Network LAG Canvas](#).

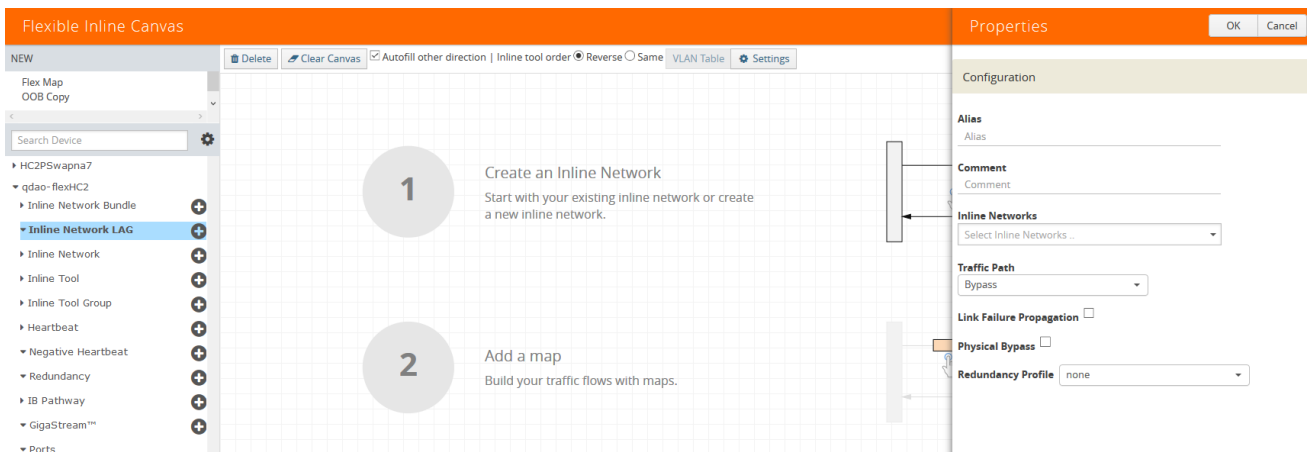


Figure 264: Inline Network LAG Canvas

4. In the Properties pane that appears on the right, enter the name and description of the inline network LAG in the **Alias** and **Comment** fields.
5. From the **Inline Networks** drop-down list, select the required inline networks that need to be part of the inline network LAG.
6. From the **Traffic Path** drop-down list, select one of the following options:

- **Bypass**—All traffic arriving at Port A of the inline network is directly forwarded to Port B of the inline network. Similarly, all traffic arriving at Port B of the inline network is directly forwarded to Port A of the inline network.
 - **Drop**—Traffic is not exchanged between the inline network ports (all traffic coming to these ports is dropped).
 - **Bypass with Monitoring**—All traffic is forwarded as a forced bypass value and a copy of the traffic is also forwarded to the inline tools. A traffic map must first be configured between the inline network and the inline tool to have the traffic forwarded with no traffic taken from the inline tools.
 - **To Inline Tool**—Traffic is forwarded to the sequence of inline tools.
7. Select the **Link Failure Propagation** check box if you want to bring down a port when its pair goes down.
 8. Select the **Physical Bypass** check box if you want the traffic to flow directly between Port A and Port B of the inline network pair when a device or a module is powered down.
 9. If there is a group of links, which are part of a port channel that use LACP, select the **Bypass Link Aggregation Control Protocol** check box to maintain the port channel functionality on the links that are connected to inline network LAG ports.
 10. Click **OK** to save the configuration.
 11. Drag the **Inline Network LAG** object to the canvas.
 12. Configure the required flexible inline maps and then, click **Deploy**. Refer [Figure 265: Inline Network LAG Deployed](#).

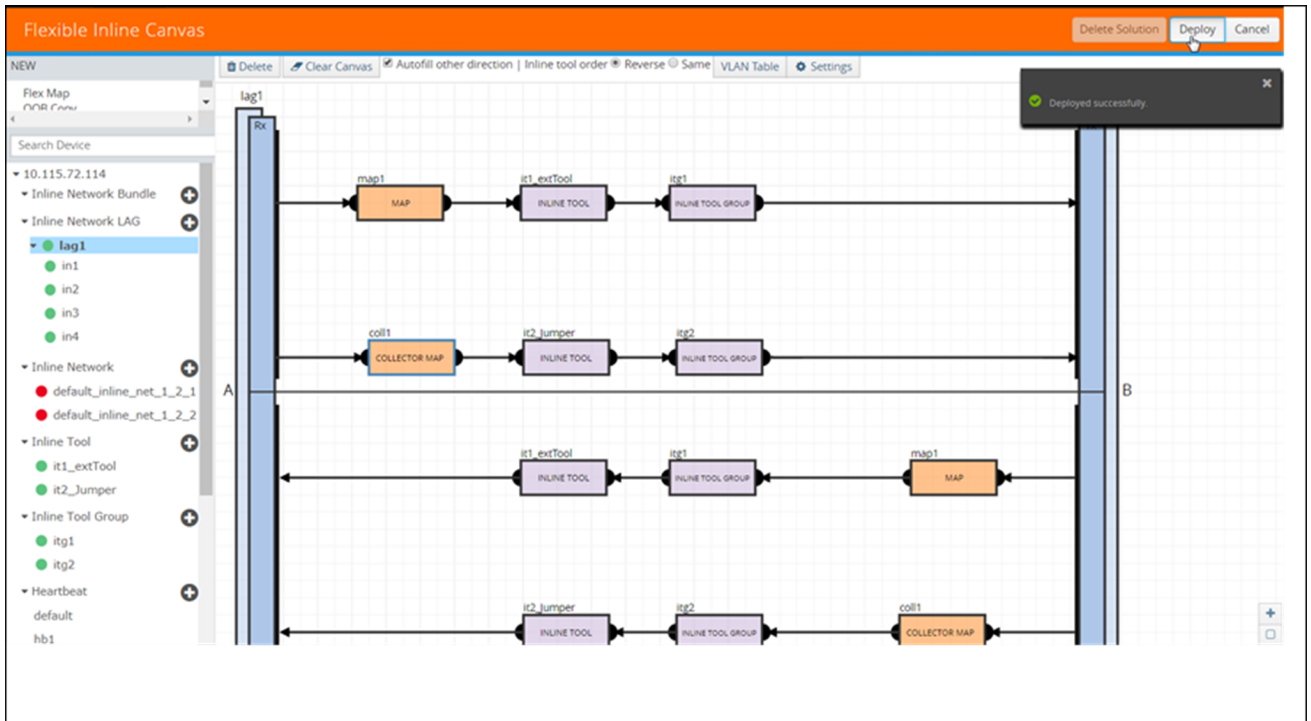


Figure 265: Inline Network LAG Deployed

Configure Inline Network Bundle

The Flexible inline network bundle feature allows you to group multiple inline networks into an inline network bundle. You can configure flexible inline maps with the inline network bundle as the source. GigaVUE-FM configures separate inline maps for each inline networks that are grouped in the inline network bundle. The inline maps are configured based on the Tool Side VLAN tags for the multiple inline networks and the rules that you specified when configuring the inline map for the network bundle.

Before you configure an inline network bundle, ensure that you configure the required inline network ports and inline networks. Refer to [Configure Inline Network Ports and Inline Network](#).

To configure an inline network bundle:

1. Go to **Physical > Inline Flows**, and then click **Configuration Canvas** to create a new Flexible Inline Canvas.
2. In the **Flexible Inline Canvas** that is displayed, select the required device for which you want to configure the inline network bundle.
3. Click the '+' icon next to the **Inline Network Bundle** option to create a new inline network bundle.
4. In the **Alias** field, enter the name of the inline network bundle.

- From the **Inline Networks** drop-down list, select the required inline networks that you want to add to the inline network bundle.
- Click **OK** to save the configuration.
- Drag and drop the inline network bundle into the canvas, and then configure the required inline map. Refer [Figure 266: Inline Network Bundle—Map Configuration](#).

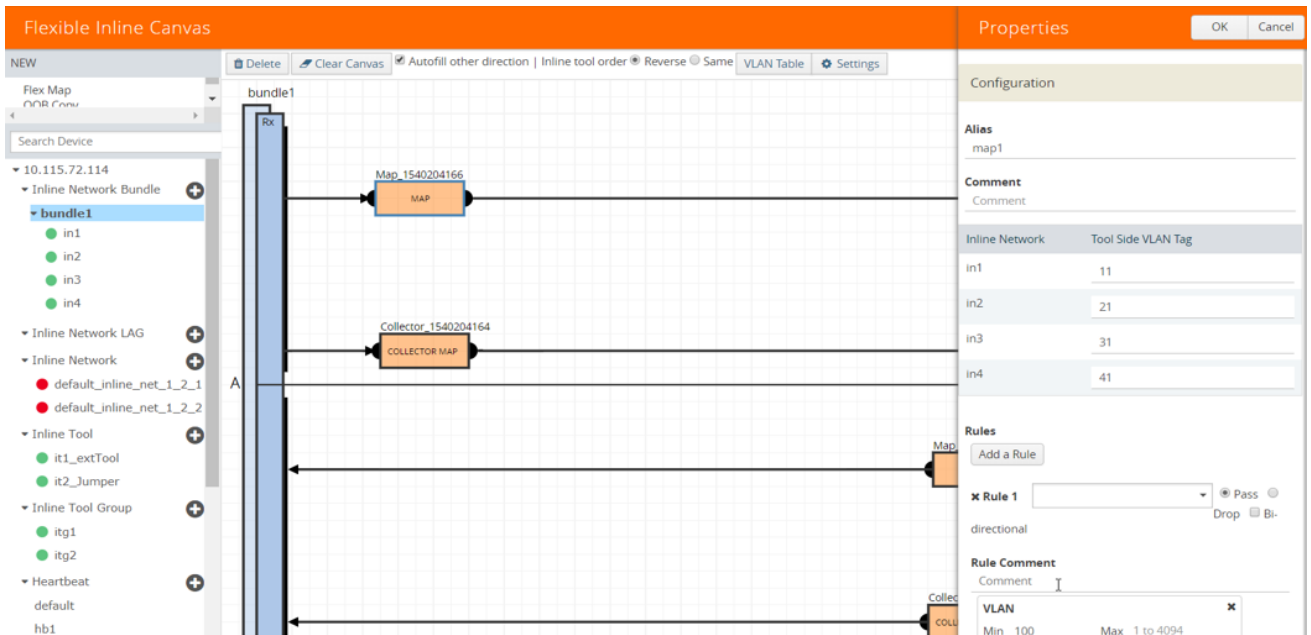


Figure 266: Inline Network Bundle—Map Configuration

- Enter the **Tool Side VLAN Tag** for each inline network added in the inline network bundle.
- Add the required rules for the inline map, and then click **OK** to save the configuration.
- Click **Deploy**. GigaVUE-FM configures separate inline maps for each inline networks that are grouped in the inline network bundle. Refer [Figure 267: Inline Network Bundle—Deployed](#).

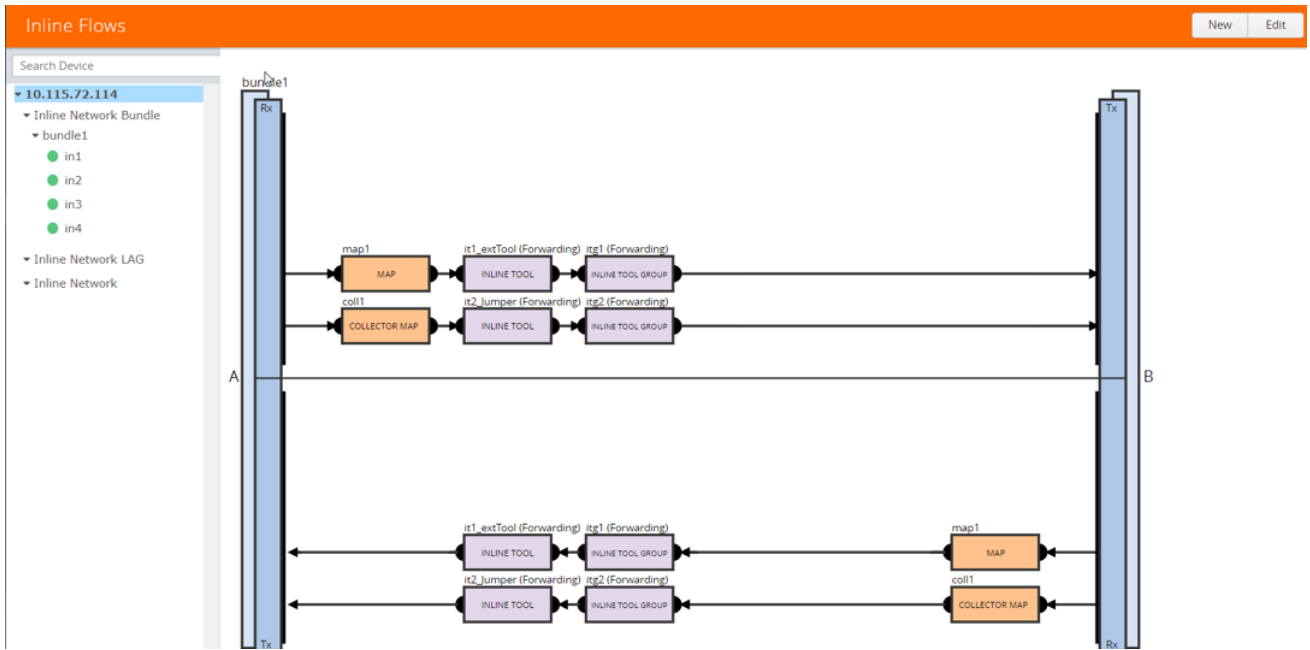


Figure 267: Inline Network Bundle—Deployed

Configure Inline Tool Ports and Inline Tools

An inline tool consists of a pair of inline tool ports that run at the same speed, on the same medium (fiber or copper). Both the inline tool ports must be on the same GigaVUE-HC series node. Moreover, the inline tool ports must be on the same GigaVUE-HC series node in which the inline network ports reside. The inline tools are attached to the inline tool ports.

An inline tool can also be a pass-through device that performs packet inspection and selective forwarding, such as Intrusion Protection System (IPS). This is a physical device, external to the GigaVUE HC series node.

To configure the inline tool ports and the inline tools:

1. Go to **Physical > Inline Flows**, and then click **Configuration Canvas** to create a new Flexible Inline Canvas.
2. In the Flexible Inline Canvas that is displayed, select the required device for which you want to configure the inline tool.
3. Click the '+' icon next to the **Inline Tool** option to create a new inline tool.
4. In the **Properties** pane, in the **Alias** and **Comment** fields, enter a name and description for the inline tool, and then click **Port Editor**.
5. In the **Quick Port Editor**, scroll down to the inline tool ports that you wish to configure. Select **Enable** to administratively enable the inline tool ports, and then click **OK**.

6. From the **Port A** and **Port B** drop-down lists, select the inline tool ports according to the direction the inline tool expects traffic from the network.
7. Verify that the **Enabled** check box is selected.
8. From the **Failover action** drop-down list, select one of the following options:
 - **Tool Bypass**—For every map involving the inline tool or inline tool group that triggered this failover action, the traffic coming to such an inline tool or inline tool group is redirected to the next inline tool or inline tool group in the ordered list defined in Port A and Port B or to the respective inline network port.
 - **Network Bypass**—All inline networks configured as the source of any map involving the inline tool or inline tool group that triggered this failover action, will be put in the bypass mode, that is, all traffic coming to side A will be directed to side B and vice versa.
 - **Tool Drop**—For every map involving the inline tool or inline tool group that triggered this failover action, the traffic coming to such an inline tool or inline tool group is dropped and the traffic is redirected to a dummy VLAN with no members.
 - **Network Drop**—All inline networks configured as the source of any map involving the inline tool or inline tool group that triggered this failover action, will be put in the drop mode, that is, all traffic coming to side A or side B will be dropped.
 - **Network Port Forced Down**—For all inline networks configured as the source of any map involving the inline tool or inline tool group that triggered this failover action, the inline network ports will be brought down.
9. Select the **Recovery Mode** as **manual** or **automatic**.
10. Select the **Enable** check box for the **Inline tool Sharing mode** if you want to define additional tags on the tool side.

NOTE: If you choose to disable the **Inline tool Sharing mode**, the inline tool can be used only in one flexible inline map.

11. From the **Flex Traffic Path** drop-down list, select one of the following options:
 - **Drop**—Traffic is dropped at the inline tool.
 - **Bypass**—Traffic bypasses the inline tool. Use this option for performing maintenance on an inline tool.
 - **Monitoring**—Traffic is fed to the inline tool and absorbed, while a copy of the traffic is sent to the next inline tool in the sequence. Traffic returned from side B of the network is also absorbed at the inline tool in the monitoring mode.
 - **To Inline Tool**—Traffic is forwarded to the inline tool.
12. Select the **Enable** check box below the **Regular Heartbeat**, if required, and then from the **Regular Heartbeat Profile** drop-down list, select a suitable profile.

13. In the HB IP Address A and HB IP Address B fields, enter the IP address of side A and side B defined in the Heartbeat profile.
14. Select the **Enable** check box below the **Negative Heartbeat**, if required, and then from the **Negative Heartbeat Profile** drop-down list, select a suitable profile.
15. Click **OK** to save the configuration.
16. Drag the **Inline Tool** object to the canvas.
17. Configure the required flexible inline maps and then, click **Deploy**.

Configure Inline Tool Group

An inline tool group is an arrangement of multiple inline tools. Traffic is distributed to the inline tools that are part of an inline tool group based on hardware-calculated hash values. For example, if one tool in a group goes down, traffic is redistributed to other tools in the group using hashing. You can also configure redundancy, such as 1+1 and N+1.

The inline tool ports that make up the inline tools participating in the inline tool group are always in pairs, running at the same speed, on the same medium (fiber or copper). All inline tool ports of the inline tool group must be on the same GigaVUE-HC3 or GigaVUE-HC2 node, but can be on different modules on the node. On the GigaVUE-HC1, all the inline tool ports of the inline group must be on either the base module or the bypass combo module. The inline tool ports must also be on the same GigaVUE-HC3, GigaVUE-HC2, or GigaVUE-HC1 node as the inline network ports.

In a cluster environment, you can configure the inline tool group on GigaVUE HC Series nodes through the cluster master. The inline constructs must all be configured on one GigaVUE-HC3, GigaVUE-HC2, or GigaVUE-HC1 node, not across nodes, even if the nodes are in a cluster.

Resilient weighted hashing provides you the ability to distribute traffic to the inline tools by assigning either an equal weight or a custom weight to the inline tools. You can assign custom weight in percentage or ratio. If an inline tool in a group goes down and the group maintains the **Minimum Healthy Group Size** that is defined for the group, the traffic is redistributed to the remaining tools based on the equal weight or the custom weight assigned to the tools. If the inline tool group does not meet the **Minimum Healthy Group Size** defined for the group, the traffic is redistributed based on the **Failover Action** defined for the group.

NOTE: Resilient hashing is not supported for classic inline maps.

Before you configure an inline tool group, ensure that you configure the required inline tools. Refer to [Configure Inline Tool Ports and Inline Tools](#).

To configure an inline tool group:

1. Go to **Physical** > **Inline Flows**, and then click **Configuration Canvas** to create a new Flexible Inline Canvas.
2. In the Flexible Inline Canvas that is displayed, select the required device for which you want to configure the inline tool group.
3. Click the '+' icon next to the **Inline Tool Group** option to create a new inline tool group.
4. In the **Properties** pane, in the **Alias** and **Comment** fields, enter a name and description for the inline tool group.
5. From the **Inline Tools** drop-down list, select the required inline tools.
6. From the **Weighting** drop-down list, select one of the following options:
 - **Equal**—Traffic is distributed equally to all the inline tools in the inline tool group. This is the default option.
 - **Relative**—Traffic is distributed to the inline tools in the inline tool group based on the relative weight or ratio assigned to the respective inline tools. The valid range is 1–256.
 - **Percentage**—Traffic is distributed to the inline tools in the inline tool group based on the percentage assigned to the respective inline tools. The valid range is 1–100.

If you select **Relative** or **Percentage** as the weighting option, enter the hash weights for the inline tools that appear in the table below the **Weighting** drop-down list. Ensure that you assign a hash weight for each inline tool in the inline tool group. However, asymmetrical hashing is not supported for **Relative** or **Percentage** options.

7. From the **Inline Spare Tool** drop-down list, select the inline tool to which the traffic will be forwarded when the first failure occurs in the set of primary inline tools.

NOTE: You cannot select an inline spare tool if you have selected a **Weighting** option.

8. Select the **Enabled** check box to make the inline tool group available for deployment.
9. Select the **Release Spare if Possible** check box to ensure that the inline spare tool is released from the active set of tools to become the spare again when the primary inline tool recovers from the failure.
10. From the **Failover Action** drop-down list, select one of the following options:
 - **Tool Bypass**—For every map involving the inline tool or inline tool group that triggered this failover action, the traffic coming to such an inline tool or inline tool group is redirected to the next inline tool or inline tool group in the ordered list defined in Port A and Port B or to the respective inline network port.
 - **Network Bypass**—All inline networks configured as the source of any map involving the inline tool or inline tool group that triggered this failover action, will be put in the bypass mode, that is, all traffic coming to side A will be directed to side B and vice versa.

- **Tool Drop**—For every map involving the inline tool or inline tool group that triggered this failover action, the traffic coming to such an inline tool or inline tool group is dropped.
 - **Network Drop**—All inline networks configured as the source of any map involving the inline tool or inline tool group that triggered this failover action, will be put in the drop mode, that is, all traffic coming to side A or side B will be dropped.
 - **Network Port Forced Down**—For all inline networks configured as the source of any map involving the inline tool or inline tool group that triggered this failover action, the inline network ports will be brought down.
11. From the **Failover Mode** drop-down list, select **Spread** to redistribute all the traffic coming from the inline network (or inline network group) to the active inline tools (excluding the failed inline tool or tools).

NOTE: This field is not applicable when there is only one inline tool in the tool list.

12. From the **Minimum Healthy Group Size** drop-down list, select the minimum number of inline tools that must be up so that the entire inline tool group is considered to be up. The minimum number must include the inline spare tool as well.
13. From the **Hash** drop-down list, select one of the following options to distribute packets across a number of inline tools that belong to the inline tool group:
- **Advanced**—Specifies symmetrical hashing, which is derived from the combination of packet fields based on the criteria selected for the advanced-hash algorithm. The most common choice of criteria for the advanced-hash algorithm is the combination of source IP and destination IP addresses. This produces a hash value that sends all traffic associated with the same session to the same inline tool in the inline tool group.
 - **SideA as sourceIP & SideB as destinationIP**—Specifies asymmetrical hashing, which is derived from the source IP address for side A of the inline network and the destination IP address for side B of the inline network. This produces a hash value that sends all traffic associated with the same source address residing on side A to the same inline tool in the inline tool group, regardless of destination or session.
 - **SideB as sourceIP & SideA as destinationIP**—Specifies asymmetrical hashing, which is derived from the destination IP address for side A of the inline network and the source IP address for side B of the inline network. This produces a hash value that sends all traffic associated with the same source address residing on side B to the same inline tool in the inline tool group, regardless of destination or session.

NOTE: This field is not available for selection if you have selected the **Relative** or **Percentage** options in the **Weighting** drop-down list.

14. From the **Flex Traffic Path** drop-down list, select one of the following options:
 - **Drop**—Traffic is dropped at the inline tool group.
 - **Bypass**—Traffic bypasses the inline tool group. Use this option for performing maintenance on an inline tool group.
 - **Monitoring**—Traffic is fed to the inline tool group and absorbed, while a copy of the traffic is sent to the next inline tool in the sequence. Traffic returned from side B of the network is also absorbed at the inline tool group in the monitoring mode.
 - **To Inline Tool**—Traffic is forwarded to the inline tool group.
15. Click **OK** to save the configuration.
16. Drag the **Inline Tool Group** object to the canvas.
17. Configure the required flexible inline maps and then, click **Deploy**.

Configure Inline Single Tag

During the flexible Inline bypass operations, network traffic sent to Inline-tools contains an extra VLAN tag. The extra VLAN tag is used to help distinguish the traffic coming from inline-tools and to make sure traffic is routed to the right inline networks. Using extra VLAN tags often presents problems for various inline-tools. The flexible Inline single tag can be used to replace the extra VLAN tag on incoming traffic. Using flexible inline single tags, you can map incoming VLANs on the network side to the outgoing VLANs on the tool side.

NOTE: The **OOB Copy** tag attribute **none** is invalid for single tag maps. The attribute **original** should be used.

To configure an inline single tag:

1. Go to **Physical > Inline Flows**, and then click **Configuration Canvas** to create a new Flexible Inline Canvas.
2. In the Flexible Inline Canvas that is displayed, select the required inline network from the list of devices.
3. Drag and drop the inline network into the canvas.
4. Click **Settings** to open the **Settings** pane. Refer [Figure 268: Flexible Inline - Enable Show Single Tag Options](#).

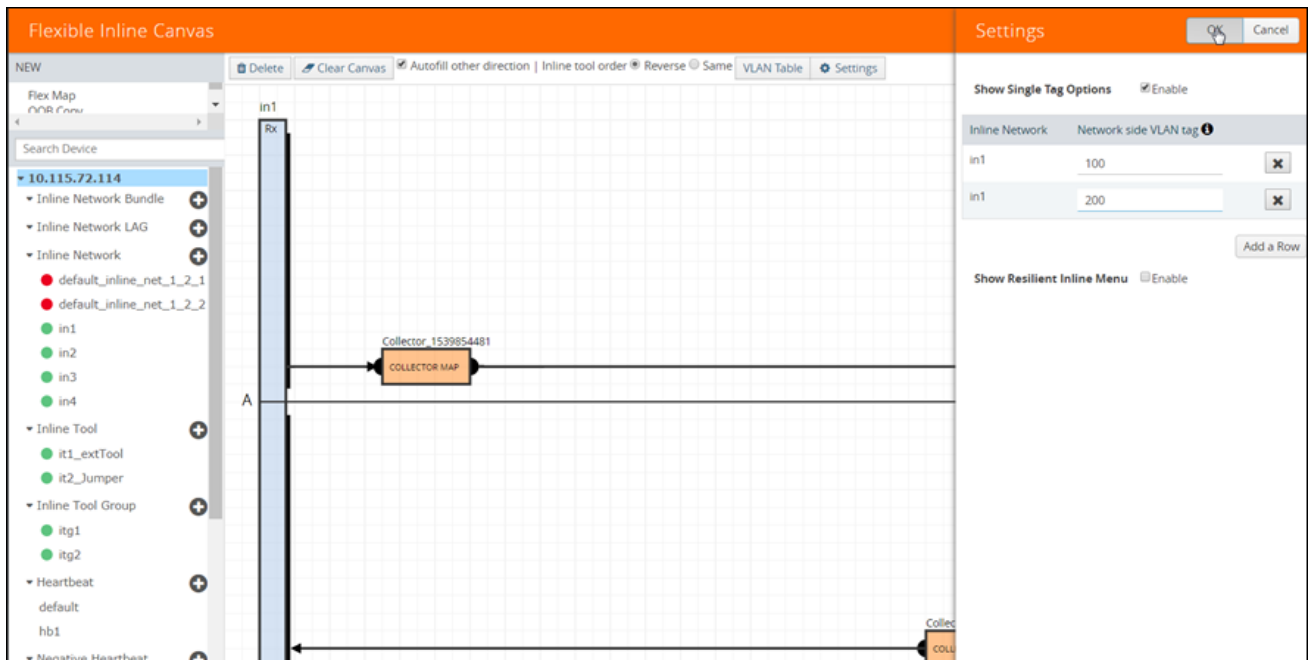


Figure 268: Flexible Inline - Enable Show Single Tag Options

5. Select the **Enable** check box for the **Show Single Tag Options**, and then enter the VLANs expected on the inline network.
6. Drag and drop a flexible inline map object into the canvas, and then click the map to open the **Properties** pane.
7. Select the **Enable** check box for the **Single Tag Mode**, and then enter the tool side VLAN tags. The VLAN qualifier is added to the rules by GigaVUE-FM. If you do not specify any rules, GigaVUE-FM adds a rule with the VLAN qualifier to the map. Refer [Figure 269: Flexible Inline - Single Tag -VLANs](#).

NOTE: You can choose to enable or disable the **Single Tag Mode** for collector maps, if required.

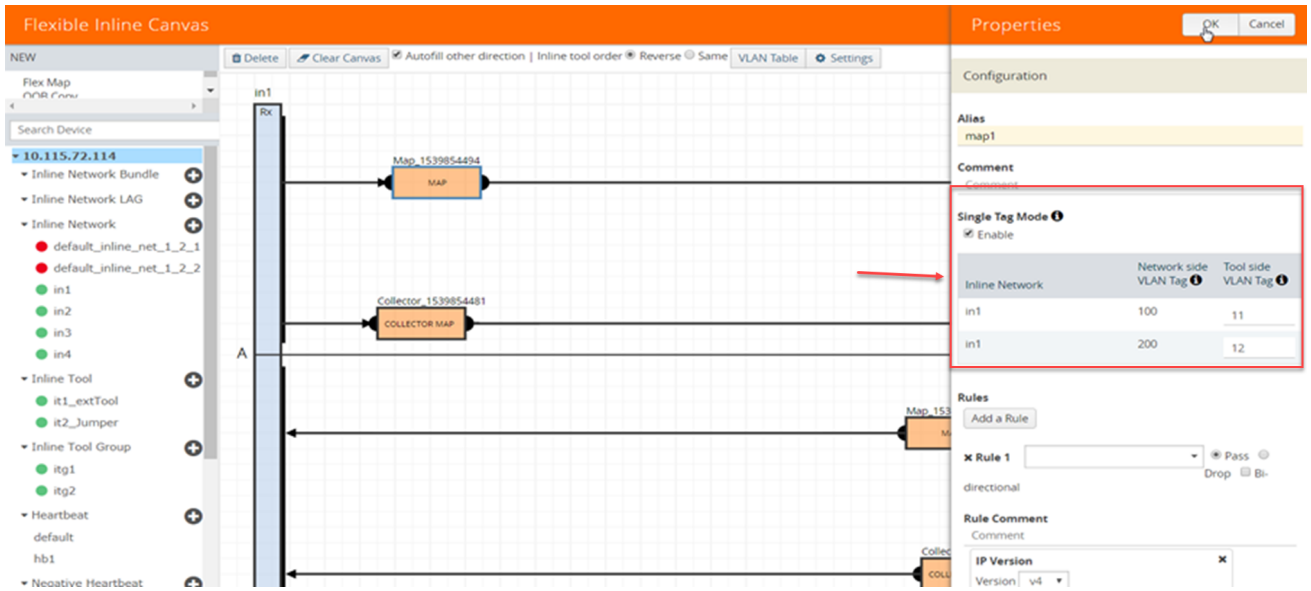


Figure 269: Flexible Inline - Single Tag -VLANs

8. Drag and drop the required inline tools into the canvas.
9. Drag and drop the OOB Copy into the canvas, if required. Refer [Figure 270: Flexible Inline Single Tag - OOB-Copy](#).

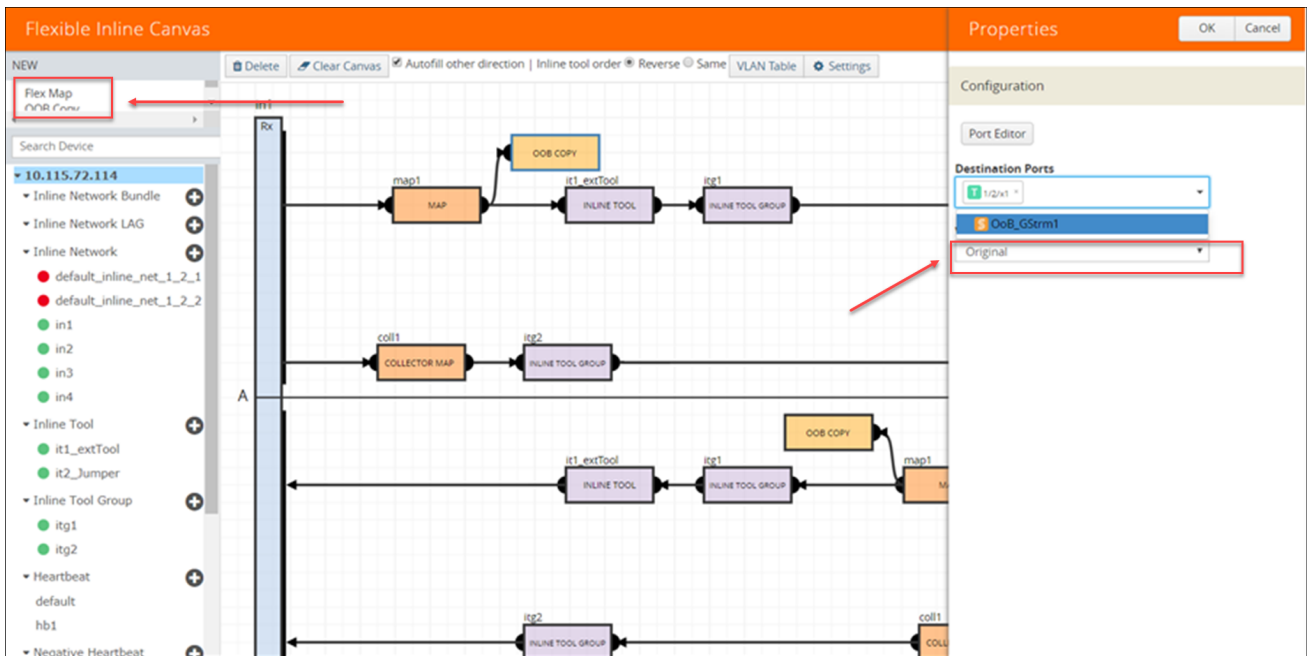


Figure 270: Flexible Inline Single Tag - OOB-Copy

10. Click **Port Editor**, and then in the **Quick Port Editor**, scroll down to the hybrid or tool ports that you wish to configure. Select **Enable** to administratively enable the ports, and then click **OK**.

11. From the **Destination Ports** drop-down list, select the required hybrid or tool ports that you want to configure as destination ports. You can also select a hybrid or tool GigaStream. For information about GigaStream, refer to "How to Use GigaStream" section.
12. From the **VLAN Tag** drop-down list, select the required tags.
13. Click **OK** to save the configuration.
14. Click **Deploy**. Refer [Figure 271: Flexible Inline - Single Tag Deploy](#).

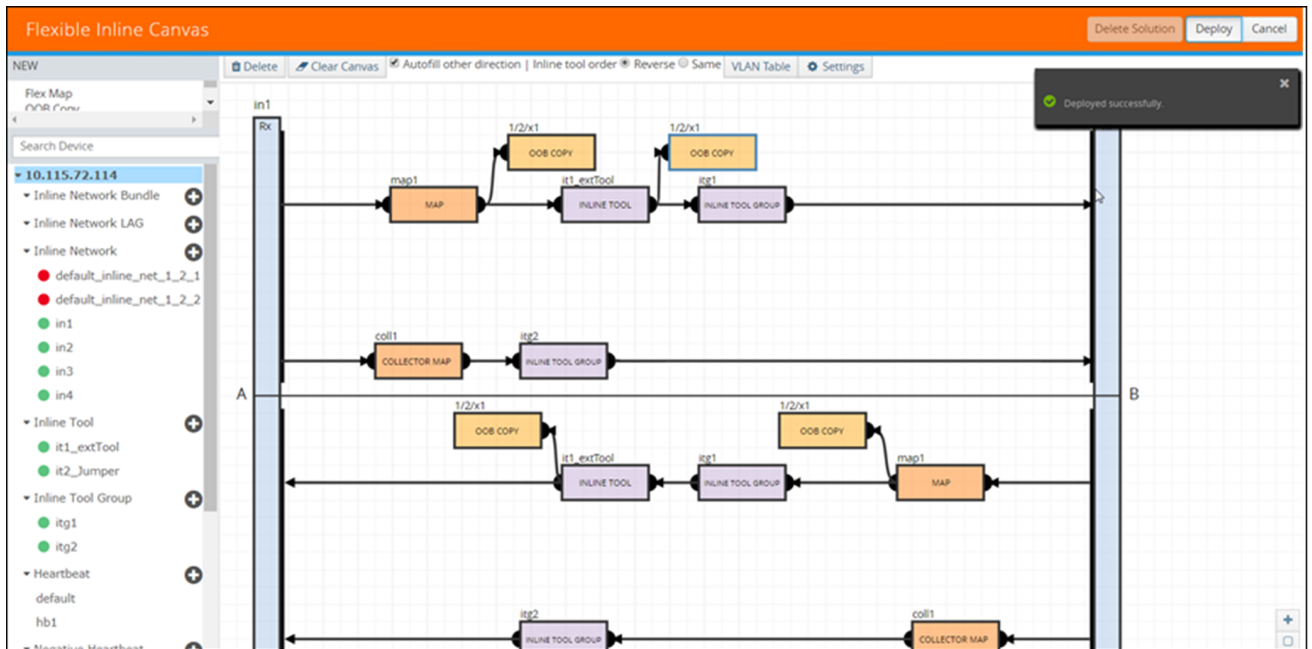


Figure 271: Flexible Inline - Single Tag Deploy

Configure Resilient Inline Arrangement

Refer to the following sections that provide details about the resilient inline arrangement feature and instructions on how to configure it:

- [About Resilient Inline Architecture](#)
- [About Inter-broker Pathway \(IB-P\)](#)
- [Resilient Inline Arrangement—Rules and Notes](#)
- [Configure a Resilient Inline Arrangement](#)

About Resilient Inline Architecture

Resilient inline arrangements is a method of configuring and deploying inline threat prevention tools for dual-path, redundant network architectures. A successful deployment of resilient inline arrangements provides traffic management for dual-path high availability environments.

The following figure illustrates the resilient inline architecture.

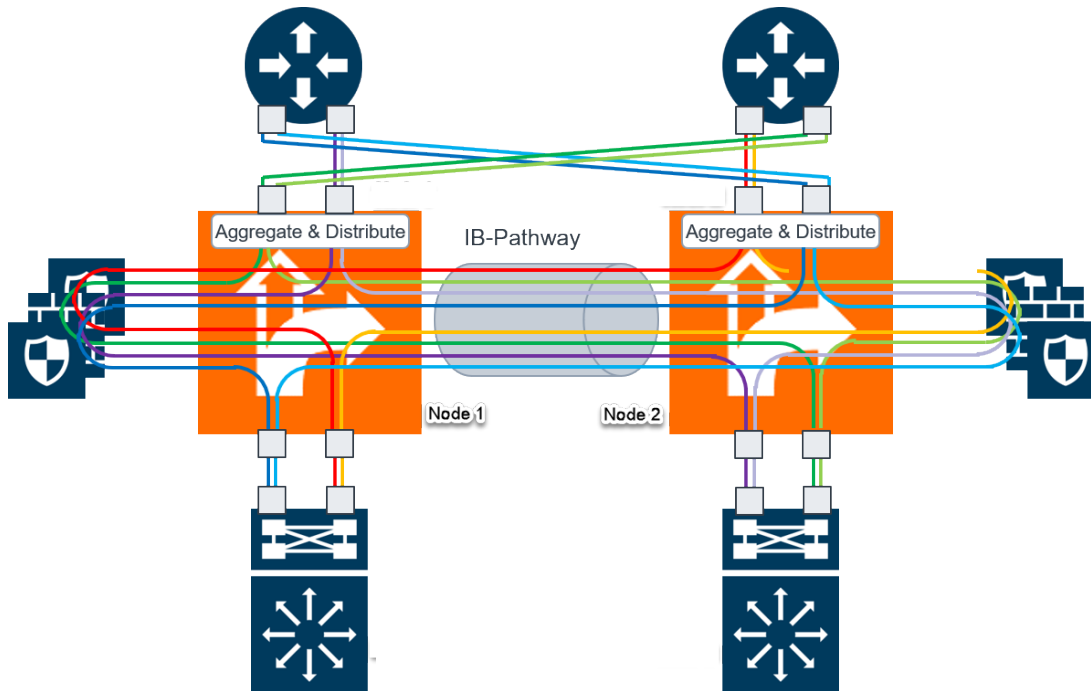


Figure 272: Resilient Inline Architecture

The resilient inline architecture shows the Gigamon devices, which consolidate the traffic from multiple intercepted links before routing the traffic to inline tools. To protect such an inspection arrangement from any failure of the Gigamon devices, a redundant arrangement of inline packet broker is shown. Both the inline packet brokers are interconnected by an Inter-broker Pathway (IB-P). Each inline packet broker is attached to a set of inline tools that are identical to each other, that is, both inline packet brokers must have equal number of inline tools. Moreover, the inline tools on both sides must be of the same type, port speed, and processing capacity.

Resilient inline arrangement is based on an aggregation and distribution principle that divides the packets received by an inline packet broker, between Node 1 and Node 2. The inline packet broker on the left, guides the Node 1 class of packets through its local tools and Node 2 class of packets through the remote tools that are reachable by a resilient inter-broker pathway. Similarly, the inline packet broker on the right, guides the Node 2 class of packets through its local tools and Node 1 class of packets through the remote tools.

Each link intercepted by the inline packet broker must be configured with the following component maps:

- either a bidirectional original component map or two unidirectional original component maps,
- two unidirectional export component maps, and

- two unidirectional import component maps.

GigaVUE-FM configures the required export and import component maps for all the links that are intercepted by both the inline packet brokers. GigaVUE-FM configures the maps based on the tool side VLAN tags and the rules that you specified when configuring the flexible inline map.

About Inter-broker Pathway (IB-P)

The inter-broker pathway provides link aggregation and distribution and is responsible for moving traffic between Node 1 and Node 2. You must configure tool ports in the inter-broker pathway.

Following are the IB-P states:

- inter-broker pathway-up—the traffic is handled as follows:
 - If the traffic is governed by the original component maps in which the traffic path is set to Bypass, the traffic bypasses the sequence of inline tools and inline tool groups and is re-directed to the opposite-side inline network port.
 - If the traffic is governed by the export component maps in which the traffic path is set to any value other than Bypass, the traffic is routed through the inter-broker pathway based on the tag value defined in the map. If the tag value matches the VLAN attribute configured in the import component map, the traffic is sent to the inline packet broker on the opposite side. The traffic is then routed through the inline tools or inline tool groups based on the sequence defined in the import component map. After inspection, the traffic is sent back to the inter-broker pathway with the same tag value. Finally, the traffic is intercepted by the export component map and is guided to the respective exit inline network port.
- inter-broker pathway-down—the traffic is handled based on the failover action selected for the inline map configured, as follows:
 - If the failover is set to 'bypass', the traffic is passed directly between the respective inline network ports.
 - If the failover is set to 'original-map', the traffic is passed through the path that is defined by the respective original map.

NOTE: Traffic can be moved from 'bypass' to 'original-map' and vice versa, when the inter-broker pathway is in 'down' state.

The failover-action set for an inline tool or an inline tool group that is configured on Node 2 will affect the inter-broker pathway as follows (Refer [Figure 272: Resilient Inline Architecture](#)):

- If the failover-action for the inline tools on Node 2 is set to 'network-bypass', all traffic received on the Node 2 will be by-passed and referred back to Node 1.
- If the failover-action is set to 'network-drop', all traffic received on Node 2 of the inter-broker pathway will be dropped.

- If the failover-action is set to 'network-port-forced-down', all ports on Node 2 of the inter-broker pathway will be brought down.

Resilient Inline Arrangement—Rules and Notes

Keep in mind the following rules and notes when working with Resilient Inline Arrangement:

- Ensure that the names on both GigaVUE devices are identical, that is, the inline networks, inline tools, inline tool groups, out-of-band tools, and out-of-band tool GigaStreams must all have the same alias names on both the devices.
- If you choose to use the inline network bundle, the alias of the inline network bundle on both the devices must be identical. However, the inline networks that are grouped into the bundle can have different aliases.
- Resilient inline arrangement does not support single VLAN tags.

Configure a Resilient Inline Arrangement

Following are the prerequisites that you must complete before you configure Resilient inline arrangement:

- Configure the required inline networks. Refer to [Configure Inline Network Ports and Inline Network](#).
- Configure the required inline network LAG. Refer to [Configure Inline Network Link Aggregation Group \(LAG\)](#).
- Configure the required inline tools. Refer to [Configure Inline Tool Ports and Inline Tools](#).
- Configure the required inline tool group. Refer to [Configure Inline Tool Group](#).

To configure a resilient inline arrangement:

1. Go to **Physical > Inline Flows**, and then click **Configuration Canvas** to create a new Flexible Inline Canvas.
2. In the Flexible Inline Canvas that is displayed, select the required device for which you want to configure the resilient inline arrangement.
3. Click the '+' icon next to the **IB Pathway** option to create a new inter-broker pathway.
4. In the **Properties** pane, in the **Alias** and **Comment** fields, enter a name and description for the inter-broker pathway, and then click **Port Editor**.
5. In the **Quick Port Editor**, scroll down to the tool ports that you wish to configure. Select **Enable** to administratively enable the required tool ports, and then click **OK**.
6. From the **Ports** drop-down lists, select the tool ports that you have configured.

7. In the **Minimum Ports Up** field, enter the minimum number of tool ports that must be operationally up so that the status of the inter-broker pathway will be up.
8. From the **Traffic Path** drop-down list, select one of the following options:
 - **Bypass**—Traffic bypasses the inter-broker pathway and is redirected to the next inline network port.
 - **Monitoring**—Traffic is forwarded to the sequence of inline tools in the monitoring mode.
 - **To Inline Tool**—Traffic is forwarded to the sequence of inline tools that you have configured.
9. Click **OK** to save the configurations.
10. Drag and drop the required inline network or inline network LAG in to the flexible inline canvas, and then click **Settings**.
11. In the **Settings** pane, select the **Show Resilient Inline Menu** check box.
12. Select the required **Node 1**, **Node 2**, **IB Pathway1**, and **IB Pathway2** for the resilient inline arrangement.
13. From the **Hashing Source** drop-down list, select one of the following options:
 - **Side A**—Hashing is done based on either the source IP address or the source port from side A. On side B, hashing is done based on either the destination IP address or the destination port.
 - **Side B**—Hashing is done based on either the source IP address or the source port from side B. On side A, hashing is done based on either the destination IP address or the destination port.
14. From the **Hashing Type** drop-down list, select one of the following options:
 - **L3 (IP Based)**—Hashing is done based on IP address.
 - **L4 (Port Based)**—Hashing is done based on transport layer port number.
15. From the **Hashing LSB Node** drop-down list, select one of the following options:
 - **Node1 as 0**—All traffic from IP addresses ending with 0 will be hashed to node 2.
 - **Node2 as 0**—All traffic from IP addresses ending with 0 will be hashed to node 1.

NOTE: This field is available only if you select the **L3 (IP Based)** option in the **Hashing Type** field.

16. From the **Hashing Port** drop-down list, select one of the following options:
 - **Node1 as odd**—All traffic with odd port numbers will be hashed to node 2 and traffic with even port numbers will be hashed to node 1.

- **Node2 as odd**—All traffic with odd port numbers will be hashed to node 1 and traffic with even port numbers will be hashed to node 2.

NOTE: This field is available only if you select the **L4 (Port Based)** option in the **Hashing Type** field.

17. Click **OK** to save the settings.
18. Drag and drop the flexible inline map into the canvas.
19. In the **Properties** pane, in the **Alias** and **Comment** fields, enter the name and description of the inline map.
20. Enter the **Tool Side VLAN Tag** for the inline network for which you are configuring the map.
21. From the **FlexInline Failover** drop-down list, select one of the following options:
 - **Bypass**—the traffic is passed directly between the respective inline network ports.
 - **Original Map**—the traffic is passed through the path that is defined in this flexible inline map.
22. Add the required rules for the inline map, and then click **OK** to save the configuration.
23. Drag and drop the required inline tools or inline tool group into the canvas.
24. Drag and drop the **OOB Copy** into the canvas, if required.
25. Click **Deploy** and a Deploy pop-up window appears.

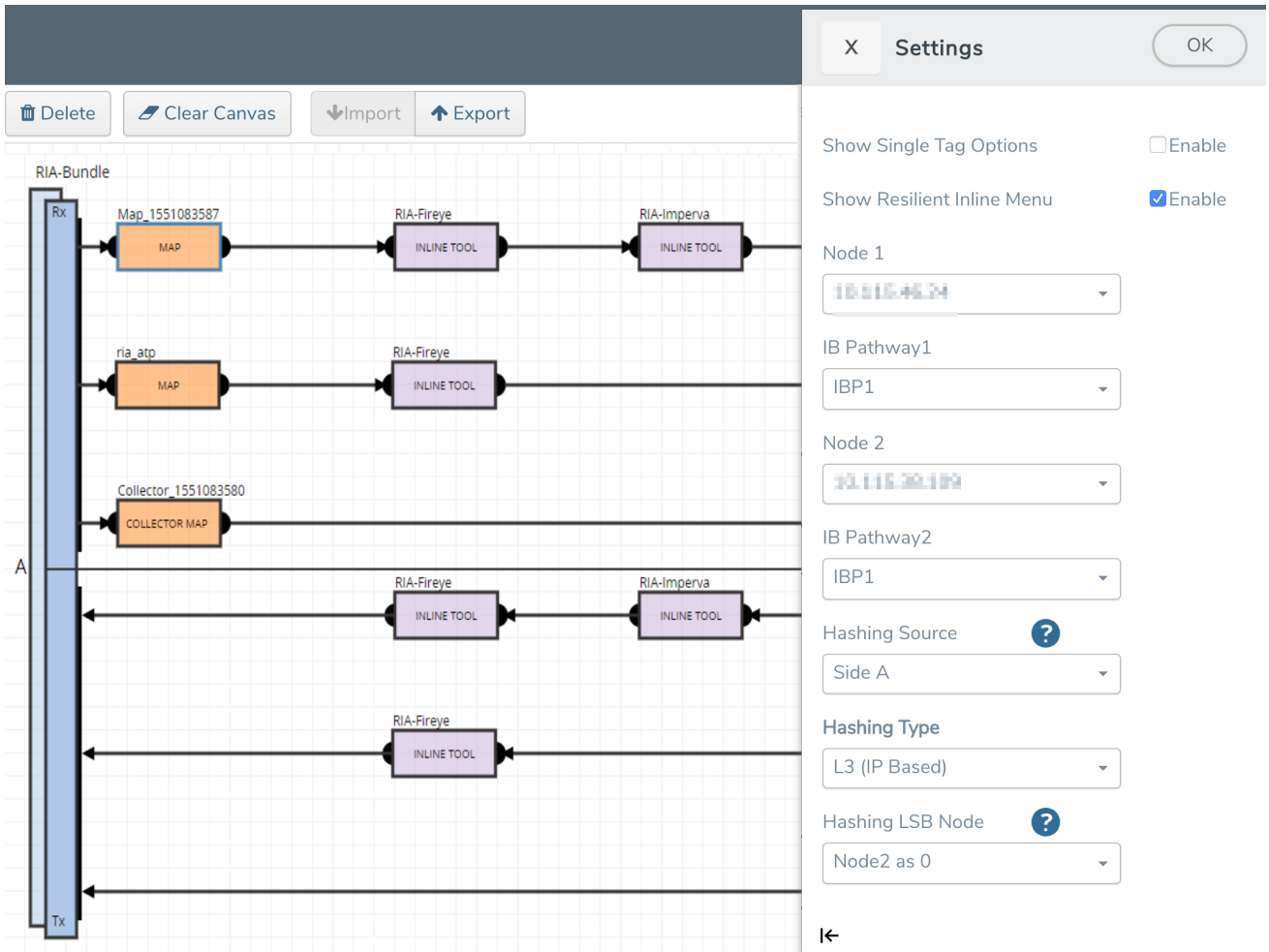


Figure 273: Resilient Inline Arrangement–Deployed

26. In the Deploy pop-up window, select a traffic path and click **OK**.

Configure Flexible Inline Decryption Solution

Refer to the following sections that provide details about the flexible inline decryption solution and instructions on how to configure it:

- [About Flexible Inline Decryption Solution](#)
- [Benefits of Flexible Inline Decryption Solution](#)
- [Flexible Inline Decryption Solution—Rules and Notes](#)
- [Configure Flexible Inline Decryption Solution](#)

About Flexible Inline Decryption Solution

The flexible inline decryption solution combines the flexible inline arrangements feature with the inline decryption solution. It includes the GigaSMART-based packet processing, which is the inline decryption functionality into the flexible inline arrangements framework. In the flexible inline

decryption solution, the outer maps guide the inline traffic to GigaSMART for preprocessing. The inner map guides the traffic processed by GigaSMART through a user-defined sequence of inline tools and inline tool groups.

Figure 274: Flexible Inline Decryption Solution illustrates an example of how the inline decryption functionality is incorporated in the flexible inline arrangements framework to form the flexible inline decryption solution.

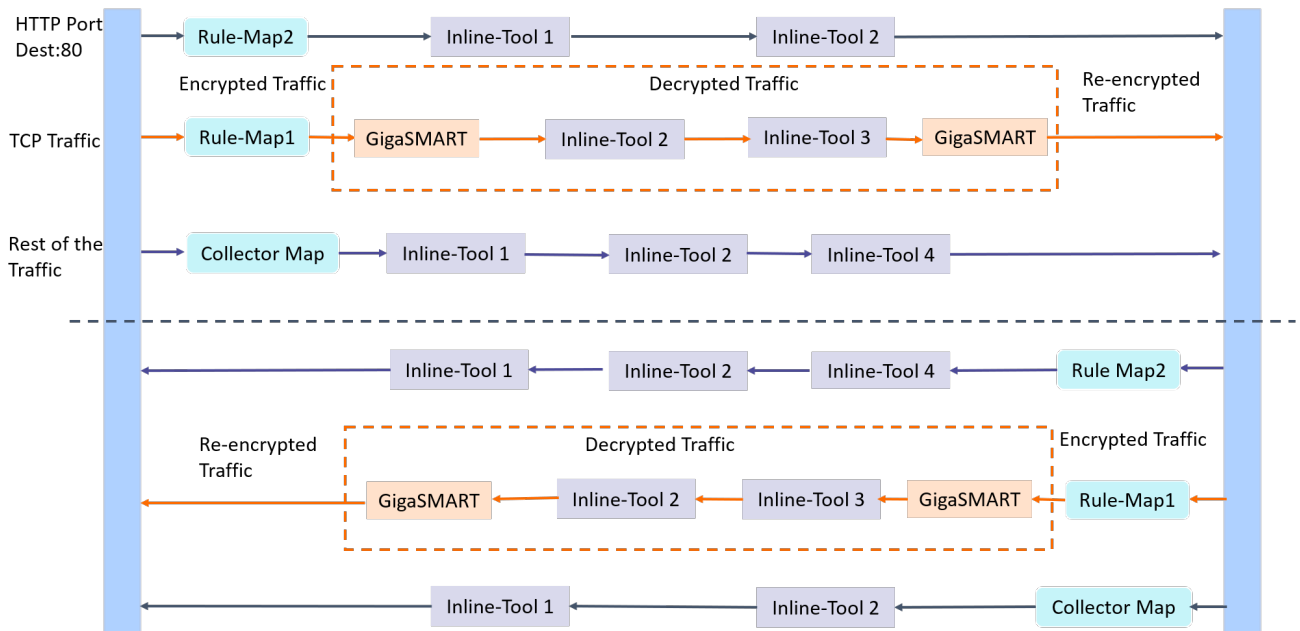


Figure 274: Flexible Inline Decryption Solution

In this example, the HTTP Port Destination:80 traffic is guided through the Flexible inline map, Rule Map2 to the sequence of inline tools, Inline Tool 1 and Inline Tool 2. The TCP traffic is encrypted and guided through Rule Map1 to GigaSMART, where it is decrypted and guided to Inline Tool 2 and Inline Tool 3. The decrypted traffic is guided back to GigaSMART, and then it is re-encrypted and routed to the network. Here, the Rule Map 1 is the outer map, which guides the traffic to GigaSMART for preprocessing. The inner map guides the traffic processed by GigaSMART through a series of inline tools or inline tool groups.

The rest of the traffic is guided through the Collector Map to a series of inline tools, and then to the network.

Figure 275: Flexible Inline Decryption Maps illustrates the different maps that guide the traffic in the flexible inline decryption solution.

The outer maps are similar to the flexible inline maps but include virtual port alias along with inline tools and inline tool groups as the destination port. The same virtual port alias can be used in multiple outer maps.

Depending on the flexible inline decryption solution that you create, there may be two types of inner maps:

- Inner Proxy Maps, which guides the traffic from GigaSMART to the inline tools or inline tool groups.
- Inner Non-proxy Maps or Network-end Maps, which guide the traffic that is bypassed from GigaSMART to the inline tools or inline tool groups.

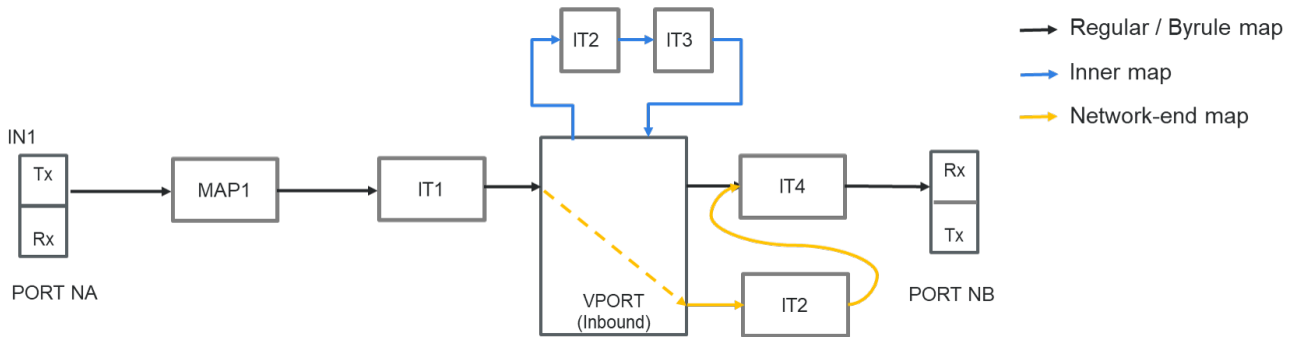


Figure 275: Flexible Inline Decryption Maps

Benefits of Flexible Inline Decryption Solution

The flexible inline decryption solution incorporates the inline decryption with the flexible inline arrangement and offers the following benefits:

- Enables you to perform the inline decryption configuration, required map deployments, and flexible inline flow configurations, all in one canvas.
- Shares the same inline tool or inline tool group across multiple inline network links and across multiple inline maps. Refer to [Figure 276: Flexible Inline SSL APP—Deployed](#).
- Allows you to tap OOB copies of decrypted traffic from GigaSMART, either before or after the inspection of security tools. Refer to [Figure 276: Flexible Inline SSL APP—Deployed](#).
- Allows you to selectively decrypt and guide traffic to the attached inline tools or inline tool groups.

Flexible Inline Decryption Solution—Rules and Notes

Keep in mind the following rules and notes when working with flexible inline decryption solution:

- When you want to migrate from the inline decryption to the flexible inline decryption solution,

- ensure that you delete all the inline decryption virtual ports, GigaSMART, and maps configurations, and then reconfigure them using the flexible inline canvas. However, if there are OOB maps from the inline network ports, before you delete the OOB maps, ensure that the **Traffic Path** for the inline network is not set to 'Bypass'.
- It is recommended to delete the OOB map from vPort before deleting other maps. If the OOB map from the vPort is not deleted while deleting all the inline SSL maps, then GigaVUE-FM throws an error on first time. You need to click **Delete All** again to delete all the maps.
- Modifying the VLAN settings on an out-of-band map is not allowed if another out-of-band map has the same port as destination.
- When there is a multiple tool failover across the inner and outer maps; and if any of the tool comes up, the traffic in the inline network does not flow as expected.
- If you want to switchover from the flexible inline decryption solution to the inline decryption solution, you must delete the flexible inline SSL APP, and then reconfigure the ports, GigaSMART, and maps using the inline decryption workflow.

Configure Flexible Inline Decryption Solution

Following are the prerequisites that you must complete before you configure the flexible inline decryption solution:

- Configure the required inline networks or inline network bundle. Refer to [Configure Inline Network Ports and Inline Network](#) or [Configure Inline Network Bundle](#).
- Configure the required inline tools. Refer to [Configure Inline Tool Ports and Inline Tools](#).
- Configure the required inline tool group. Refer to [Configure Inline Tool Group](#).
- Ensure that there are no inline decryption configurations such as inline decryption policy, inline decryption virtual port, GigaSMART group, GigaSMART operations, or inline decryption map configured on the device.

To configure a flexible inline decryption solution:

1. Go to **Physical > Inline Flows**, and then click **Configuration Canvas** to create a new Flexible Inline Canvas.
2. In the Flexible Inline Canvas that appears, select the required device for which you want to configure the flexible inline decryption solution.
3. Click the '+' icon next to the **Inline SSL APP** option to create a new flexible inline decryption solution.
4. In the **Inline SSL APP** page that appears, enter a name for the Inline SSL APP, and then complete the required fields. Refer [Inline SSL APP—Field References](#) for details.
5. Click **OK** to save the configurations.

6. Drag and drop the required inline network or inline network bundle in to the flexible inline canvas.
7. Drag and drop the flexible inline map into the canvas.
8. In the **Properties** pane, in the **Alias** and **Comment** fields, enter the name and description of the inline map.
9. Enter the **Tool Side VLAN Tag** for the inline network for which you are configuring the map.
10. Add the required rules for the inline map, and then click **OK** to save the configuration.
11. Drag and drop the Inline SSL APP into the canvas.
12. Drag and drop the required inline tools or inline tool group into the canvas.
13. Drag and drop the **OOB Copy** into the canvas, if required.
14. Click **Deploy**.

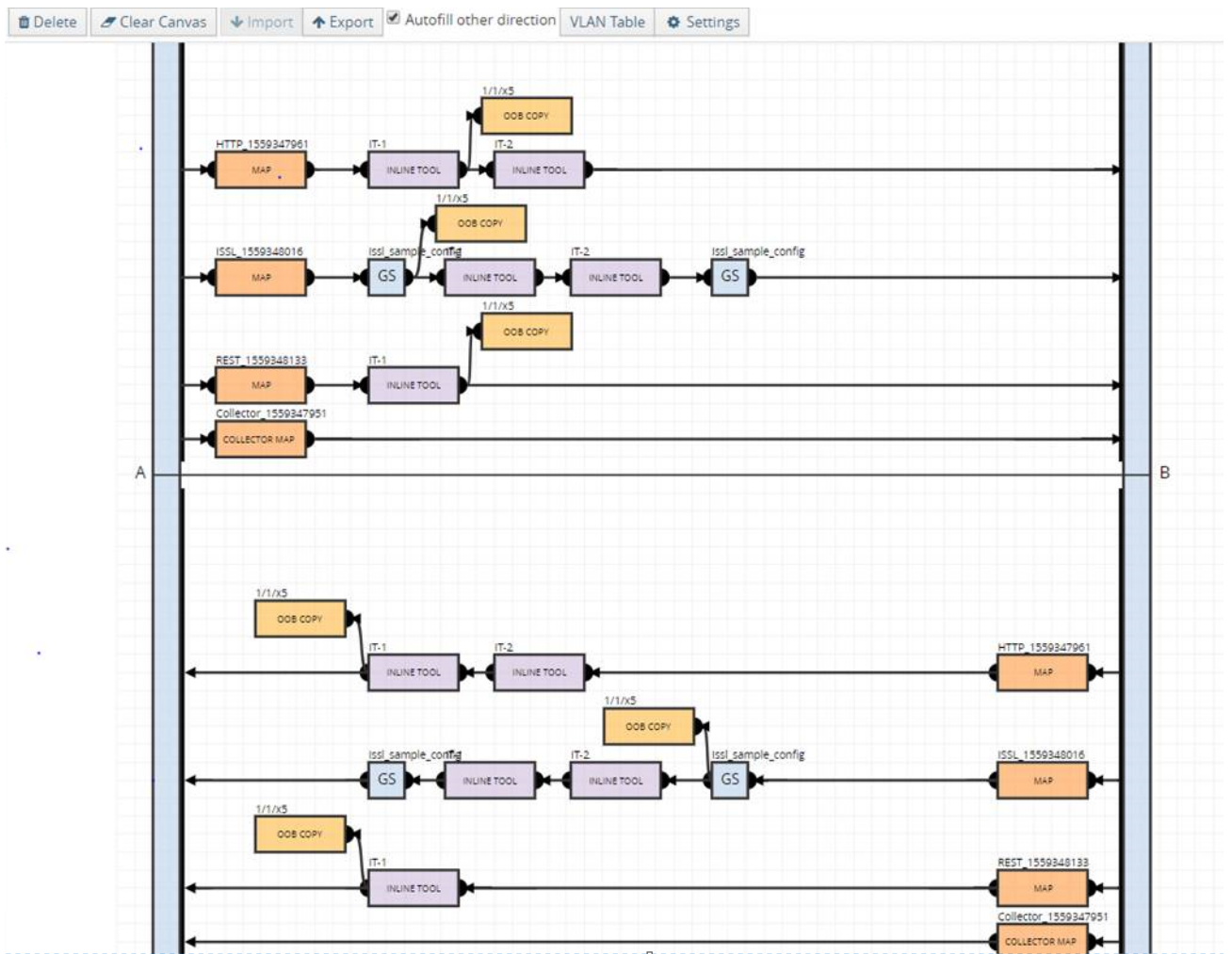


Figure 276: Flexible Inline SSL APP—Deployed

Inline SSL APP—Field References

The following table lists and describes the attributes that define the flexible inline decryption solution.

Field	Description
Alias	Enter a unique name for the flexible inline SSL APP.
GS engines	Select the required GigaSMART engines.
SSL Monitor Mode	<p>Select an SSL Monitor Mode from one of the following options:</p> <ul style="list-style-type: none"> • Enable—When the monitor mode is enabled, the SSL decryption or encryption is off. The monitor application collects information such as the TCP ports that are in use and VLAN information about the incoming traffic, and forwards the packets to the tool port or network port based on the non-SSL TCP bypass action. • Disable—This is the default value. When the monitor mode is disabled, the SSL decryption or encryption is on. Use this mode during the deployment stage. • Inline—Both monitor mode and SSL decryption or encryption is on. Use this mode to debug issues. <p>Refer to Inline SSL Monitor Mode for details.</p>
Keychain Password	<p>The keychain password must be configured before installing certificates and keys. Refer to Configure Keychain Password for details.</p> <p>To add or reset the Keychain Password:</p> <ol style="list-style-type: none"> Click Keychain Password, and then choose either Add or Reset. If you choose to reset the Keychain Password, enter a password that is 8 to 30 characters long and contains at least one numerical character, one uppercase character, one lowercase character, and one special character. Select the Auto Login check box to enable GigaVUE-FM to unlock the keystore when the device reboots. Refer to Supporting unattended restart of SSL decryption in managed nodes for details. Click OK to save the Keychain Password.
Add new keys	<p>To configure a certificate-key pair:</p> <ol style="list-style-type: none"> Click Add new keys to open the Key page. Enter a name and description for the key. Select the required Key Type and File Type. You can choose to include a Passphrase for the key, if required. Add the required Private Key and Certificate. Click OK to save the configuration.
Deployment Type	<p>Select one of the following deployment types:</p> <ul style="list-style-type: none"> • Inbound—For inbound deployments, add a new Server Key Mapping. Enter the domain name or IP address of the server, and then select the required Key Pair Alias. Refer to SSL

Field	Description
	<p>Session, Inbound Deployment for details.</p> <ul style="list-style-type: none"> • Outbound—For outbound deployments, add a primary and a secondary signing Certificate Authorities (CA). Refer to SSL Session, Outbound Deployment for details. • Hybrid—For hybrid deployments, add a new Server Key Mapping, and a primary and a secondary signing CA. <p>Refer to Keys and Certificates and Generate and Add a Certificate to Key Store for details.</p>
Configurations	
Default Action	<p>Select one of the following option:</p> <ul style="list-style-type: none"> • Decrypt—Decrypt all the traffic that is guided into the Inline SSL APP. • No Decrypt—Do not decrypt the traffic that is guided into the Inline SSL APP.
URL Cache Miss Action	<p>Select one of the following options:</p> <ul style="list-style-type: none"> • Decrypt—Decrypt all the traffic that is guided into the Inline SSL APP. • No Decrypt—Do not decrypt the traffic that is guided into the Inline SSL APP. • Defer—Delay the decryption until the Defer Timeout seconds provided.
Tool Fail Action	<p>The failover action taken in response to a failure of an inline tool. Select one of the following options:</p> <ul style="list-style-type: none"> • Bypass Tool—The traffic bypasses the failed inline tool. • Drop Connection—The traffic is dropped.
Tool Bypass	<p>Select the required options:</p> <ul style="list-style-type: none"> • Decrypted SSL Traffic—Bypasses the decrypted SSL traffic. • No Decrypted SSL Traffic—Bypasses the non-decrypted SSL traffic. • Non-SSL TCP Traffic—Bypasses the non-SSL, that is the TCP intercepted traffic.
High Availability	<p>Select the check box to detect the link switchover by upstream device that is in active or standby mode.</p> <div data-bbox="423 1409 1455 1465" style="border: 1px solid #ccc; padding: 5px; margin: 10px 0;"> <p>NOTE: Do not select this check box if the inline network links are in active state.</p> </div> <p>Refer to High Availability Active Standby for details.</p>
Network Group Multiple Entry	<p>Select this check box to allow the traffic from different inline network to reenter GigaSMART.</p> <p>Refer to Inline Network Group Multiple Entry for details.</p>
StartTLS Port	<p>Enter the required SSL/TLS ports.</p> <p>Refer to StartTLS for details.</p>

Traffic Path

Field	Description
Tool Side VLAN Tag	Enter the required tool side VLAN tag for the inline network.
Traffic Path	<p>Select one of the following options:</p> <ul style="list-style-type: none"> • Drop—Traffic is dropped at the virtual port. • Bypass—Traffic bypasses the virtual port. • Monitoring—Traffic is fed to the virtual port and absorbed, while a copy of the traffic is sent to the next inline tool in the sequence. Traffic returned from side B of the network is also absorbed at the virtual port in the monitoring mode. <div style="border: 1px solid #ccc; padding: 5px; margin: 10px 0;"> <p>NOTE: You can select the Monitoring option only if you have set the SSL Monitor Mode to either Enable or Inline.</p> </div> <ul style="list-style-type: none"> • To Inline Tool—Traffic is forwarded to the inline tool. This is the default value.
Inline Failover Action	<p>Select one of the following options:</p> <ul style="list-style-type: none"> • Virtual port bypass—All virtual ports configured as the source of any map that triggered this failover action, will be put in the bypass mode, that is all traffic will bypass the virtual port and will be guided to the inline tool or inline tool group. • Virtual port drop—All virtual ports configured as the source of any map that triggered this failover action, will be put in the drop mode, that is all traffic will be dropped at the virtual port. • Network bypass—All inline networks configured as the source of any map involving the inline tool or inline tool group that triggered this failover action, will be put in the bypass mode, that is, all traffic coming to side A will be directed to side B and vice versa. • Network drop—All inline networks configured as the source of any map involving the inline tool or inline tool group that triggered this failover action, will be put in the drop mode, that is, all traffic coming to side A or side B will be dropped. • Network port forced down—For all inline networks configured as the source of any map involving the inline tool or inline tool group that triggered this failover action, the inline network ports will be brought down.
Security Exceptions	<p>You can choose to either decrypt or drop the traffic for the following certificates:</p> <ul style="list-style-type: none"> • Self-signed certificate • Unknown CA certificate • Invalid certificate • Expired certificate <p>You can also choose to configure the security exceptions for certificate revocation validation based on OCSP or CRL on inline decryption profile. Select one of the following options:</p> <ul style="list-style-type: none"> • Soft Fail—If you select this option, the client browser displays the secondary MitM

Field	Description
	<p>certificate and the inline decryption session stats in GigaVUE-FM displays as Decrypt.</p> <ul style="list-style-type: none"> • Hard Fail—If you select this option, the client browser displays the certificate from DigiCert and the inline decryption session stats in GigaVUE-FM displays as Bypass: Unknown Revocation. <p>Refer to Certificate Revocation List (CRL), Online Certificate Status Protocol (OCSP), CRL and OCSP, and Checking Certificate Revocation Status for details.</p>
Whitelist/Blacklist	<p>Select the following check boxes:</p> <ul style="list-style-type: none"> • Whitelist—Allows traffic from certain classes such as sites, domains, and host-based IP address to bypass decryption. • Blacklist—Allows traffic from certain sites, domains, and host-based IP address to always be decrypted. <p>Refer to Whitelisting Policy and Blacklisting Policy for details.</p>
Policy Rules	<p>Add the required policy rules for the inline decryption profile.</p>
Network Access	<p>Network access configuration is used to get URL categorization updates. Refer to URL Categorization for details.</p> <p>To configure the network access for the GigaSMART engine ports:</p> <ol style="list-style-type: none"> Select either DHCP or IP Address as the network access configuration mode. If you select IP Address as the mode, enter the IP Address, Netmask, Gateway, DNS, MTU, and VLAN. Select either Eth2 or Eth3 as the Interface. <div data-bbox="428 1142 1455 1199" style="border: 1px solid #ccc; padding: 5px; margin-top: 10px;"> <p>NOTE: The Eth3 option is available only for GigaVUE-HC3 devices.</p> </div>
Decryption Port Mapping	<p>The TCP destination port for decrypted traffic sent to inline tools can be configured as part of the inline decryption profile. Configure the required Priority 1 map, which is user configurable and Priority 2 map, which is the default out port.</p> <p>Refer to Inline SSL Decryption Port Map for details.</p>
Trust Store	<p>The trust store contains a trusted certificate authority (CA) for server validation. You can choose to either append or replace the trust store.</p> <p>Refer to Trust Store for details.</p>
TCP Settings	<p>Configure the required TCP settings as follows:</p> <ul style="list-style-type: none"> • TCP Inactive Timeout—TCP Inactive session timeout in minutes • TCP Delayed ACK—GigaSMART Inline SSL decryption ACKs every TCP packet by default. If TCP Delayed ACK is enabled, then GigaSMART decryption will wait for 100ms or ACK every third packet – whichever comes first. • TCP SYN Retries—number of retries made by the MitM to initiate a session with the destination server. If a SYN/ACK response isn't received from the destination server on initial TCP SYN,

Field	Description
	GigaSMART attempts for additional number of TCP SYN Retries as defined by the user.
Miscellaneous (Global Settings)	
SSL/TLS Version	Select the minimum and maximum SSL/TLS version.
Connection Reset Action	<p>Select one of the following options for the minimum SSL/TLS version:</p> <ul style="list-style-type: none"> • Drop—Closes all sessions that are below the minimum SSL/TLS version specified. This ensures that the network is safe from the weak SSL connections. This is the default option. • No Decrypt—Bypasses all sessions that are below the minimum SSL/TLS version specified. <p>Select one of the following options for the maximum SSL/TLS version:</p> <ul style="list-style-type: none"> • No Decrypt—Bypasses all sessions that are above the maximum SSL/TLS version specified. This is the default option. • Drop—Closes all sessions that are above the maximum SSL/TLS version specified.
Caching persistence	Select this check box to allow the information to be saved on the GigaVUE node in the control card's persistent storage so that it can be retrieved in case of reboots. Refer to Cache Persistence for details.

Supporting unattended restart of SSL decryption in managed nodes

The keychain is an encrypted database of certificates and private keys. On individual nodes, the keychain is stored in flash memory until reboot. The user needs to enter keychain password to access keychain. The keychain password is cached in the RAM of the control plane processor to allow decryption of the keychain file, but the keychain password is not cached across reboots. The SSL/TLS processing is not possible without the keychain password.

The keychain password is stored in GigaVUE-FM to automatically unlock the keychain during reboots and processing the SSL decryption without any intervention. The keychain password is stored in an encrypted database for key protection and risk management. Enable the **Auto Login** option in [Inline SSL APP—Field References](#) to automatically unlock the keychain during reboots.

Troubleshoot Flexible Inline Flows

The flexible inline canvas provides you the ability to view the status of the flexible inline flow deployments, port statistics, and the details of the cluster-level maps used in the deployments. You can use these details to troubleshoot any issues or failures in your flexible inline flows.

The flexible inline canvas has the following tabs:

- **Status**—Provides details of the forwarding states of inline network. Click the required component that is part of the selected inline network to view the component’s properties. Refer to [View the Forwarding States of Inline Networks](#).
- **Statistics**—Provides statistical information of the inline network ports, inline tool ports, and the virtual ports used in the selected inline network. It also provides the inline decryption session statistics for the inline network. Refer to [Figure 277: Flexible Inline Network and Inline Tool Statistics](#).

STATUS		STATISTICS				TROUBLESHOOT	
Inline Network		default_inline_net_1_1_3					
Port A		1/1/x21					
Port B		1/1/x22					
Packet Counts		Packet Rate per Second		Drops		Errors	
PORT A	PORT B	PORT A	PORT B	PORT A	PORT B	PORT A	PORT B
Rx: 218992	219796 :Tx	Rx: 1	1 :Tx	Rx: 0	0 :Tx	Rx: 0	0 :Tx
Tx: 296447	334089 :Rx	Tx: 3	5 :Rx	Tx: 0	0 :Rx	Tx: 0	0 :Rx
Inline Tool		SSL-VA1					
Port A		1/4/x5					
Port B		1/4/x6					
Packet Counts		Packet Rate per Second		Drops		Errors	
PORT A	PORT B	PORT A	PORT B	PORT A	PORT B	PORT A	PORT B
Rx: 137804	136651 :Tx	Rx: 0	0 :Tx	Rx: 0	0 :Tx	Rx: 0	0 :Tx
Tx: 6152	5879 :Rx	Tx: 0	0 :Rx	Tx: 0	0 :Rx	Tx: 0	0 :Rx
Inline Tool		Fire-eye-APT					
Port A		1/2/x7					
Port B		1/2/x8					
Packet Counts		Packet Rate per Second		Drops		Errors	
PORT A	PORT B	PORT A	PORT B	PORT A	PORT B	PORT A	PORT B
Rx: 307082	307082 :Tx	Rx: 0	0 :Tx	Rx: 0	0 :Tx	Rx: 0	0 :Tx
Tx: 347138	347138 :Rx	Tx: 2	2 :Rx	Tx: 0	0 :Rx	Tx: 0	0 :Rx

Figure 277: Flexible Inline Network and Inline Tool Statistics

- **Troubleshoot**—Provides details about the device-level maps that are created for the selected inline network. The details include the source of the map, inline tools or inline tool groups used in the A to B and B to A directions, tool side and network side VLAN tags, and OOB copies. Click the required component to view its configuration details. It also provides details about the map statistics. In case of inline tool group, you can view the list of inline tools that are associated with the inline tool group. Click the required inline tool from the list to view its configurations. Refer to [Figure 278: Flexible Inline Network and Inline Tool Troubleshoot](#).

STATUS	STATISTICS	TROUBLESHOOT				
Cluster level Maps						
▼ ING-Bundle (Inline Network Bundle)						
▼ default_inline_net_1_1_3						
▼ FmAuto-Web-Traffic_default_inline_net-20a73719-7412-41e4-8011-96df2b5b1409						
Comment	CREATED BY GIGAVUE-FM. DO NOT MODIFY OR DELETE, processed map: Web-Traffic_default_inline_net_1_1_3					
Priority	1					
Source	● default_inline_net_1_1_3					
AtoB Tools	● SSL-VA1, ● Fire-eye-APT, ● SSL-VA2					
BtoA Tools	Reverse					
Tool Side VLAN Tag	auto 3997					
▼ Rules						
Rule	Type	Bi-directional	Packets	Octets	Conditions	Comments
Rule 1	Pass	No	73583	9839834	portDst: 443	

Figure 278: Flexible Inline Network and Inline Tool Troubleshoot

To troubleshoot any issue or failure in your flexible inline flow:

1. From the flexible inline canvas, go to the **Status** tab to check the forwarding states of the required inline network.
2. Go to the **Statistics** tab to check the port statistics to ensure that there are no drops, errors, or discards.

NOTE: Click the **Statistics** tab again to refresh the data.

3. Go to the **Troubleshoot** tab to check the required map configurations and isolate the issue.

For instructions on how to troubleshoot a specific issue, refer to [Example: Troubleshoot Traffic Issues Between Side A and Side B](#).

Example: Troubleshoot Traffic Issues Between Side A and Side B

This section provides you an example of how to troubleshoot a specific issue using the flexible inline canvas.

Consider that you have an inline network IN1 with one by-rule map and one collector map. The traffic is not flowing from Side A to Side B. To troubleshoot this issue:

1. Go to **Physical > Inline Flows**.
2. Select the required device, and then drill down to the inline network that has the traffic issue.
3. Click **Status** to view the forwarding states of the inline network. Ensure that the forwarding state of the inline network is Normal. For details of the forwarding states, refer to [View the Forwarding States of Inline Networks](#).

- Click **Statistics** to view the total packet count of the inline network. The Rx count of Port A of the inline network must match the Tx count of Port B. If the count does not match, the traffic is blocked between Port A and Port B.

NOTE: To refresh the statistical data, click **Statistics** again.

- Click **Troubleshoot** to view the configurations of the by-rule and collector maps configured for the inline network.
 - Check that the by-rule map has packet count.
 - If the by-rule map has packet count, check the inline tools from A to B and B to A directions of the by-rule map to ensure that the inline tools are in up state and the **Flex Traffic Path** is set to **To inline tool**.
- Click **Statistics** to view the port statistics of the required inline tool. If the Rx count of Port A of the inline tool does not match the Tx count of Port B of the inline tool, the traffic is dropped at the inline tool. Check the inline tool and take the required action.
- If the Rx count of Port A of the inline tool matches the Tx count of Port B of the inline tool, repeat steps 5 and 6 for the collector map configured for the inline network.
- If the Rx count of Port A of the inline tool configured for the collector map matches the Tx count of Port B of the inline tool, contact Gigamon Technical Support. Refer to [Contacting Technical Support](#) on page 1231.

View the Forwarding States of Inline Networks

To view the forwarding states of inline networks in the flexible inline canvas, choose the required inline network, and then click **Status**. Refer to [Figure 279: Inline Network Forwarding States](#).

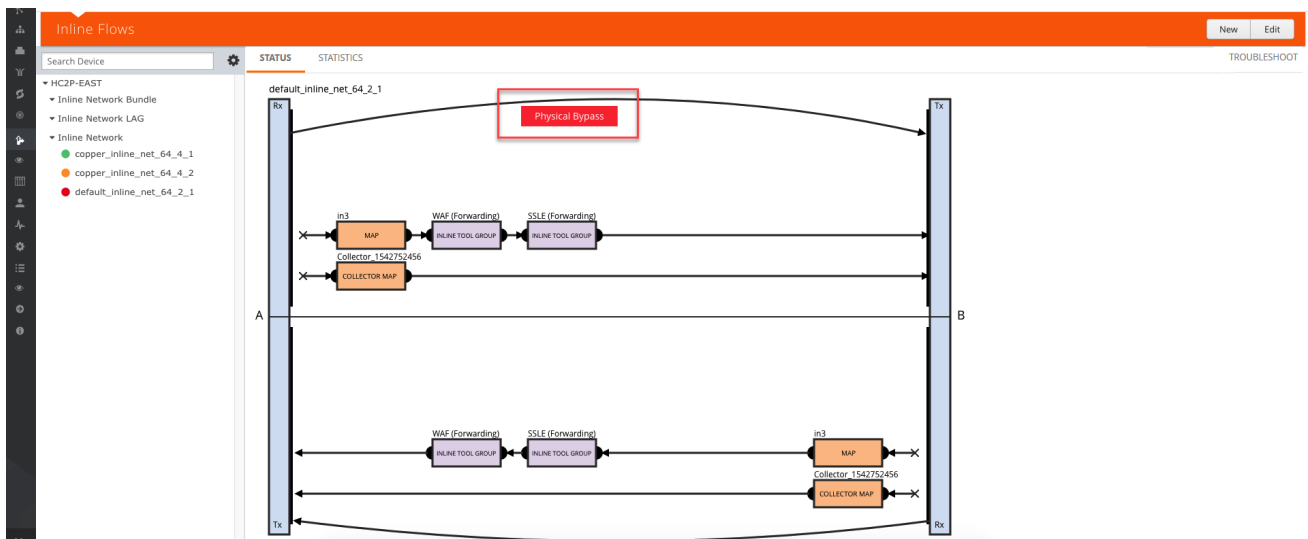


Figure 279: Inline Network Forwarding States

Following inline network states are not explicitly shown in the flexible inline canvas:

- Normal—If the state of all inline tools are up, the inline network is in Normal state.
- Abnormal—If any inline tool involved in flexible inline maps (directly or indirectly as a member of an inline tool group) is operationally down and there is no network-level failover action in effect, the inline network is in an Abnormal state.

Table 54: Forwarding States of Inline Networks provides the list of forwarding states of inline network and their description.

Table 54: Forwarding States of Inline Networks

Inline Network Physical Bypass	Inline Network Traffic Path	Far-End Status of Links Connected to Inline Network Ports	Operational State of <i>Not</i> Forced Inline Tools and Inline Tool Groups Involved in Maps from the Inline Network	Forwarding State	Description
enable	any inline network traffic path configuration	any combination of far-end ports status	any combination of operational state of the inline tools or inline tool groups involved in the maps originating from the inline network	PHYSICAL BYPASS	all traffic exchanged directly between the end nodes without being noticed by the switching fabric (GigaVUE node acting as a wire or fiber)
disable	traffic path set to drop	any combination of far-end ports status	any combination of operational state of the inline tools or inline tool groups involved in the maps originating from the inline network	DISABLED	all traffic arriving at the inline network ports is dropped
disable	traffic path set to bypass, monitoring, or to-inline-tool	at least one far-end port is down	any combination of operational state of the inline tools or inline tool groups involved in the maps originating from the inline network	DISCONNECTED	No traffic is exchanged between the nodes
disable	traffic path set to bypass	both far-end ports are up	any combination of operational state of the inline tools or inline tool groups involved in the maps originating from	FORCED BYPASS	All traffic that matches any of the maps originating from the inline network is redirected through a

Inline Network Physical Bypass	Inline Network Traffic Path	Far-End Status of Links Connected to Inline Network Ports	Operational State of <i>Not</i> Forced Inline Tools and Inline Tool Groups Involved in Maps from the Inline Network	Forwarding State	Description
			the inline network		logical bypass
disable	traffic path set to monitoring	both far-end ports are up	any combination of operational state of the inline tools or inline tool groups involved in the maps originating from the inline network	FORCED BYPASS WITH MONITORING	A copy of the traffic originating from the inline network bypasses the sequence of inline tools and inline tool groups and is re-directed to the opposite-side inline network port. Another copy of the traffic is directed to the sequence of inline tools and inline tool groups, except that no traffic of the second copy is sent to the exit port.
disable	traffic path set to to-inline-tool	both far-end ports are up	all inline tools involved (directly or indirectly as members of inline tool groups) in the maps originating from the inline network are in the <i>up</i> operational state	NORMAL	The traffic is guided between the source inline network port and the destination inline network port according to the status of the inline tools and inline tool groups NOTE: The state of all inline tools must be <i>up</i> , including inline tools configured as spare in an inline tool group, inline tools or inline tool group members in the a-to-b and b-to-a lists configured with any traffic path other than to-inline-tool.
disable	traffic path	both far-end	at least one of the inline	NETWORK	No traffic is exchanged

Inline Network Physical Bypass	Inline Network Traffic Path	Far-End Status of Links Connected to Inline Network Ports	Operational State of <i>Not</i> Forced Inline Tools and Inline Tool Groups Involved in Maps from the Inline Network	Forwarding State	Description
	set to to-inline-tool	ports are up	tools or inline tool groups involved in the maps originating from the inline network configured with the traffic path parameter to-inline-tool and failover action of network-port- forced-down is in the <i>down</i> operational state	PORTS FORCED DOWN	between the inline network ports, and the inline network ports are brought down
disable	traffic path set to to-inline-tool	both far-end ports are up	<p>a. none of the inline tools or inline tool groups involved in the maps originating from the inline network configured with to-inline-tool and failover action network-port-forced-down is in the <i>down</i> operational state</p> <p>b. at least one of the inline tools or inline tool groups involved in the maps originating from the inline network configured with to-inline-tool and failover-action of network-drop is in the <i>down</i> operational state</p>	FAILURE INTRODUCED DROP	All traffic arriving at the inline network ports is dropped
disable	traffic path set to to-inline-tool	both far-end ports are up	a. none of the inline tools or inline tool groups involved in the maps originating from the inline network configured with to-inline-tool and	FAILURE INTRODUCED BYPASS	All traffic that matches any of the maps originating from the inline network is redirected through a logical bypass

Inline Network Physical Bypass	Inline Network Traffic Path	Far-End Status of Links Connected to Inline Network Ports	Operational State of <i>Not</i> Forced Inline Tools and Inline Tool Groups Involved in Maps from the Inline Network	Forwarding State	Description
			<p>failover action of network-port-forced-down or network-drop is in the <i>down</i> operational state</p> <p>b. at least one of the inline tools or inline tool groups involved in the maps originating from the inline network configured with to-inline-tool and failover action of network-bypass is in the <i>down</i> operational state</p>		
disable	traffic path set to to-inline-tool	both far-end ports are up	any combination of conditions not listed for the forwarding state definitions of PHYSICAL BYPASS, DISABLED, DISCONNECTED, FORCED BYPASS, FORCED BYPASS WITH MONITORING, NORMAL, NETWORK PORTS FORCED DOWN, FAILURE-INTRODUCED DROP, or FAILURE-INTRODUCED BYPASS	ABNORMAL	<p>The traffic is guided between the source inline network port according to the status of the inline tools and inline tool groups</p> <div data-bbox="1203 1213 1455 1654" style="border: 1px solid black; padding: 5px;"> <p>NOTE: If any inline tool involved in flexible inline maps (directly or indirectly as a member of an inline tool group) is in the <i>down</i> operational state and there is no network-level failover action in effect, the inline network is in the ABNORMAL state.</p> </div>

Backup and Restore Flexible Inline Flows

You must backup the devices and GigaVUE-FM at the same time. Ensure that the devices are not in operation during backup or restore. For more information, refer to the *"Restore Devices and GigaVUE-FM for Traffic Management Solutions"* section in the *"GigaVUE-OS and GigaVUE-FM Administration Guide"*.

Inline Bypass Solutions

This chapter provides the following information about inline bypass solutions:

- [About Inline Bypass Solutions](#)
- [Configure Inline Bypass Solutions](#)

About Inline Bypass Solutions

Security tools such as firewalls and intrusion protection systems (IPSs) are often connected inline on production networks, with traffic flowing from the network segment through the tool and then back onto the production network.

Inline bypass solutions involve bidirectional traffic between two networks, intercepted by a Gigamon node, and guided through one or more inline tools.

Inline bypass is a pillar of the GigaSECURE Security Delivery Platform. For an overview of GigaSECURE, refer to [About Inline Bypass Solutions](#).

Inline bypass is supported on all GigaVUE HC Series nodes: GigaVUE-HC3, GigaVUE-HC2, and GigaVUE-HC1.

This section describes inline bypass solutions. Refer to the following sections for details:

- [Introduction to Inline Bypass Solutions](#)
- [Logical Bypass and Physical Bypass](#)
- [Types of Inline Networks](#)
- [Simple and Complex Inline Bypass Solutions](#)

NOTE: The configuration of inline bypass solutions can be complex. Follow the order of configuration outlined in [Configuration Steps](#) and demonstrated in [Inline Bypass Solution Examples](#).

Introduction to Inline Bypass Solutions

Inline bypass solutions place the Gigamon node inline between two sides of a network. The Gigamon node sends uninspected traffic from one side of the network to an inline tool (such as an IPS), and then sends the inspected traffic to the other side of the network.

The reasons for deploying Gigamon's inline bypass solutions are as follows:

- to protect against inline tool failures (including loss of link to inline tools and any inline tool problems detected through heartbeat monitoring)
- to bypass the inline tools for traffic that does not need to be examined by the tools or that cannot be processed by the tools
- to distribute the traffic load among multiple tools
- to send specific traffic to specialized inline tools
- to guide traffic serially through the inline tools, with the traffic from one tool flowing to the next, so that all tools see the same traffic
- to share inline tools among multiple inline network links
- to implement tiered network security by combining inline and out-of-band, allowing the traffic to be examined by both types of tools

For improved reliability and ease of maintenance, the inline bypass solutions also provide the following:

- protection against power loss through physical bypass
- protection against power loss through the high availability solution, Gigamon Resiliency for Inline Protection (GRIP™)

Capabilities of Inline Bypass Solutions

The inline bypass solution offers the following capabilities:

- Guides traffic through one or more inline tools according to user-defined bidirectional connectivity arrangements among respective inline network ports and inline tool ports.
- Reacts to failure conditions, such as the failure of inline tools, or the failure of links leading to the end-point devices between which the inline tool is inserted.
- Configures maps to associate inline networks with inline tools and inline tool groups.
- Supports bidirectional heartbeat and negative heartbeat to monitor inline tool health.
- Supports protected and unprotected inline networks.
- Supports physical bypass with specialized hardware on GigaVUE-HC3, GigaVUE-HC2, and GigaVUE-HC1 (bypass combo modules equipped with optical protection switches)

- Supports physical bypass on GigaVUE-HC2 and GigaVUE-HC1 (TAP modules equipped with electrical relays).
- Distributes traffic across multiple inline tools, providing load sharing and traffic redistribution should a tool fail.
- Supports out-of-band maps for selective forwarding of inline traffic to monitoring tools.
- Supports sharing of inline tools by multiple inline networks.
- Supports N+1 and 1+1 inline tool redundancy for inline tool groups.
- Supports guiding inline traffic through inline tools in a serial fashion.
- Supports inline flow mapping through rule-based and shared collector inline maps.
- Provides a high availability solution, Gigamon Resiliency for Inline Protections (GRIP).

Logical Bypass and Physical Bypass

Logical bypass lets traffic bypass the inline tool should it experience a failure. A failure is declared if the GigaVUE node either loses connectivity to the inline tool or fails to receive a heartbeat from the tool.

Logical inline bypass does not require any specialized hardware and can be facilitated on regular ports on GigaVUE-HC3, GigaVUE-HC2, and GigaVUE-HC1 modules. On GigaVUE-HC1, logical inline bypass can be configured on the base module.

On the GigaVUE-HC2, fiber TAP modules and copper TAP modules (except TAP-HC0-G100C0) cannot be used to configure logical inline bypass.

Physical bypass provides protection against failure of the GigaVUE node, such as if power is lost. On GigaVUE HC Series nodes, it is implemented with specialized hardware called bypass combo modules.

The specialized hardware triggers a bypass when power is lost to the node. When the physical bypass is activated, traffic flows from one side of the network to the other, but without monitoring.

The GigaVUE-HC3 bypass combo module is a bypass switch (BPS) module, as follows:

- Bypass Combo Module with two 100Gb/40Gb SR4 MPO inline network port pairs and sixteen regular SFP+ (10Gb) port cages (BPS-HC3-C25F2G)

The GigaVUE-HC2 bypass combo modules are bypass switch (BPS) modules, as follows:

- Bypass Combo Module with four SX/SR (50/125µm multimode) inline network port pairs and sixteen regular SFP+ (1Gb/10Gb) port cages (BPS-HC0-D25A4G)

- Bypass Combo Module with four SX/SR (62.5/125µm multimode) inline network port pairs and sixteen regular SFP+ (1Gb/10Gb) port cages (BPS-HC0-D25B4G)
- Bypass Combo Module with four LX/LR (singlemode) inline network port pairs and sixteen regular SFP+ (1Gb/10Gb) port cages (BPS-HC0-D35C4G)
- Bypass Combo Module with two 40Gb SR4 (multimode) inline network port pairs and eight regular SFP+ (1Gb/10Gb) port cages (BPS-HC0-Q25A28)

NOTE: The 40Gb BPS module, BPS-HC0-Q25A28, is only supported on GigaVUE-HC2 with Control Card version 2 in this release.

The GigaVUE-HC1 bypass combo module is a bypass switch (BPS) module, as follows:

- Bypass Combo Module with two SX/SR (50/125µm multimode) inline network port pairs and four regular SFP+ (1Gb/10Gb) port cages (BPS-HC1-D25A24)

Physical bypass is also supported on the following copper TAP modules on GigaVUE-HC2 and GigaVUE-HC1:

- On the GigaVUE-HC2 copper TAP module, TAP-HC0-G100C0
- On the GigaVUE-HC1 copper TAP module, TAP-HC1-G10040

The GigaVUE-HC3, GigaVUE-HC2, and GigaVUE-HC1 offer physical and logical inline bypass. Physical bypass provides automatic failover protection in the case of a power failure. On the GigaVUE HC Series nodes, the bypass combo modules provide the physical bypass function. Or on GigaVUE-HC2 and GigaVUE-HC1, the copper TAP modules provide the physical bypass function.

The physical bypass function, as it applies to a single pair of inline network ports, is as follows:

- When the module is not powered, (either the entire node is powered down or the module is removed from the node), the inline network port pair is in the physical bypass mode. That means that traffic is exchanged directly between network Port A and network Port B of the inline network pair.
- When the module is powered, the mode (inline or bypass) of the inline network port pair is controlled through software. In the physical bypass mode, the inline network port pair behaves exactly as if the module was not powered. In the inline mode, the inline network port pair behaves as any other inline network port pair configured for working with an inline tool.

For information on the bypass combo module on GigaVUE-HC3, refer to the *GigaVUE-HC3 Hardware Installation Guide*. This document also contains procedures for installing, removing, and replacing modules in the GigaVUE-HC3.

For information on bypass combo modules or the TAP-HC0-G100C0 module on GigaVUE-HC2, refer to the *GigaVUE-HC2 Hardware Installation Guide*. This document also contains procedures for installing, removing, and replacing modules in the GigaVUE-HC2.

For information on the bypass combo module or the TAP-HC1-G10040 module on GigaVUE-HC1, refer to the *GigaVUE-HC1 Hardware Installation Guide*. This document also contains procedures for installing, removing, and replacing modules in the GigaVUE-HC1.

Refer also to [Figure 280: Physical Bypass Protection and Protected Inline Network](#).

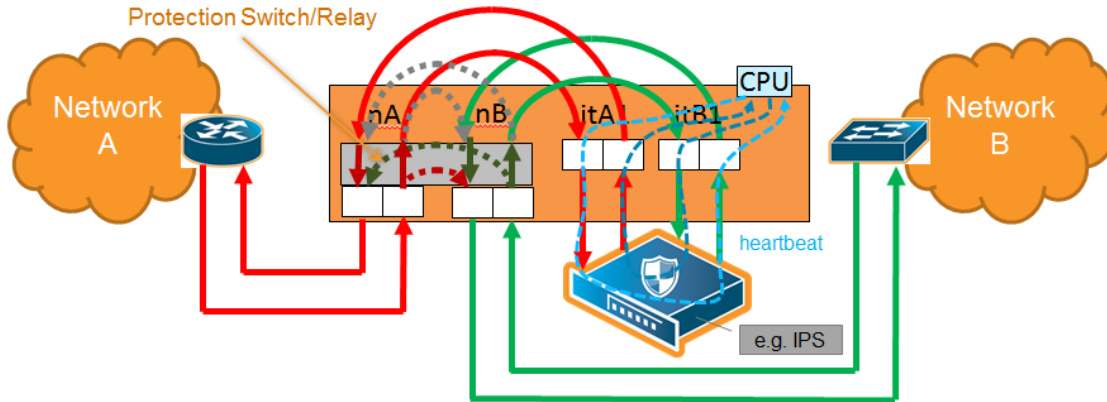


Figure 280: Physical Bypass Protection

Types of Inline Networks

The types of inline networks are described in the following sections:

- [Unprotected Inline Network](#)
- [Protected Inline Network](#)
- [Mix of Protected and Unprotected](#)

Unprotected Inline Network

An unprotected inline network consists of two ports of the inline-network type, which facilitate access to a bidirectional link between two networks (or more precisely, two far-end network devices).

Any available network type ports on a GigaVUE HC Series node can be configured to be inline-network type ports and combined to form an unprotected inline network. An unprotected inline network is shown in [Figure 281: Unprotected Inline Network](#).

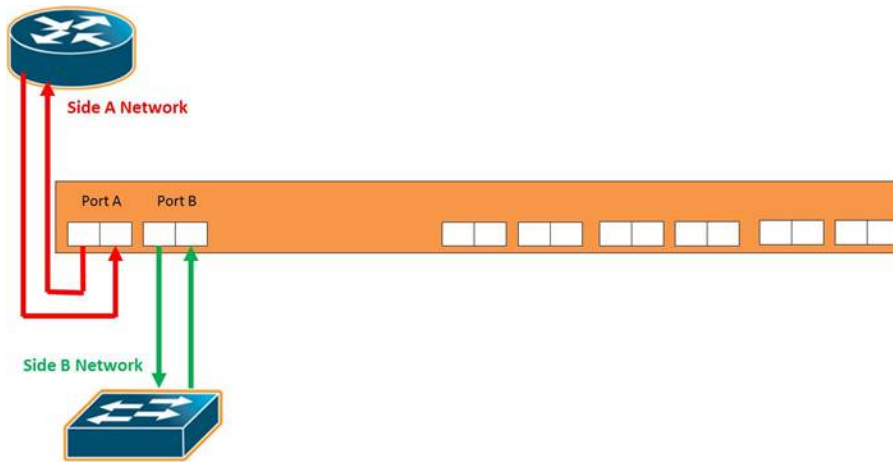


Fig. 1 Unprotected Inline Network

Figure 281: Unprotected Inline Network

Protected Inline Network

A protected inline network uses the port pairs associated with optical protection switches located on bypass combo modules on GigaVUE-HC3, GigaVUE-HC2, and GigaVUE-HC1. The specialized hardware triggers a bypass when power is lost to the node. On GigaVUE-HC2, protected inline networks for copper are supported on the TAP-HC0-G100C0 module. On GigaVUE-HC1, protected inline networks for copper are supported on the TAP-HC1-G10040 module.

Physical bypass provides protection against failure of the Gigamon node due to a loss of power. When physical bypass is activated, traffic flows from one side of the network to the other, but without monitoring.

Because of the specialized hardware, when a bypass combo module initializes, the system creates inline-network type ports for each of the protected port pairs on the module. This does not happen automatically on the TAP-HC0-G100C0 module on the GigaVUE-HC2 or on the TAP-HC1-G10040 module on the GigaVUE-HC1.

A protected inline network is shown in [Figure 282: Protected Inline Network](#).

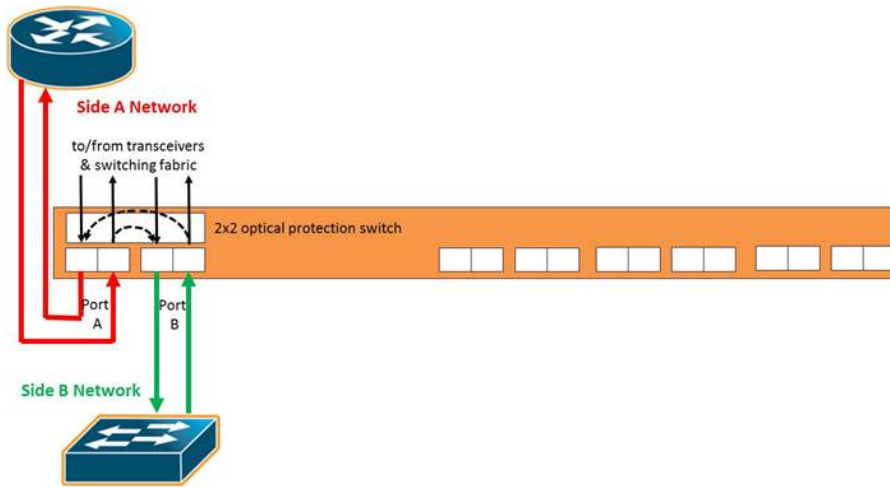


Fig. 2 Protected Inline Network

Figure 282: Protected Inline Network

Mix of Protected and Unprotected

Any combination of protected and unprotected inline networks is supported in inline bypass solutions.

Simple and Complex Inline Bypass Solutions

Simple and complex inline bypass solutions are described in the following sections:

- [Typical Configuration](#)
- [Distribution to Multiple Inline Tools](#)
- [Inline Tools in a Series](#)
- [Multiple Inline Networks](#)
- [Inline Flow Mapping®](#)
- [Send Traffic to Out-of-Band Tools](#)

Typical Configuration

In the typical or most common configuration, a single inline tool is inserted in a Network A to Network B link. All traffic is sent to the inline tool and inspected in both directions.

A typical configuration is shown in [Figure 283: Simple Configuration](#). The physical protection switch is optional and present only when using bypass combo modules or copper TAP modules.

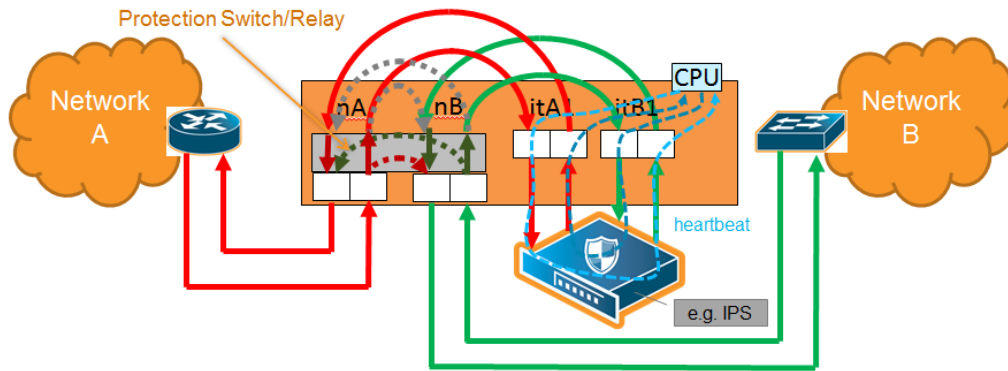


Figure 283: Simple Configuration

Distribution to Multiple Inline Tools

One of the challenges to inline monitoring is scaling the throughput of the inline tools with the speed of the network. One way to do this is to share the load across multiple inline tools.

Because inline inspection of network traffic is processor-intensive, it is common to combine the power of multiple inline tools to monitor traffic. This is especially true for 10Gb, 40Gb, and 100Gb networks and tools that only support 1Gb or 10Gb interfaces.

An inline tool group is an arrangement of multiple inline tools which share the traffic load. Traffic is sent to the tools based on standard hashing parameters. This is referred to as hash-based distribution. If a single tool in the group of tools fails, the packets will be redistributed to other tools. This ensures that all packets are inspected.

A multiple inline tool arrangement is shown in [Figure 284: Multiple Tool Arrangement](#).

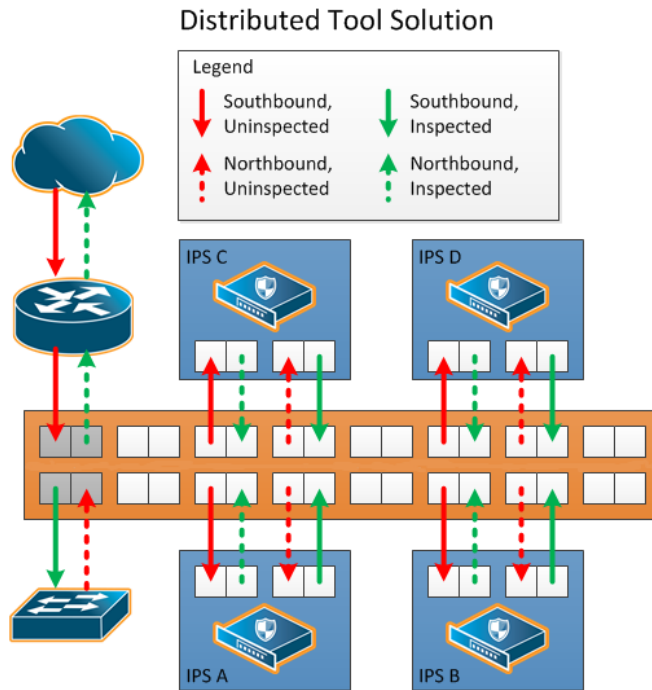


Figure 284: Multiple Tool Arrangement

Multiple tool distributions can be non-redundant or have 1+1 or N+1 redundancy. [About Inline Tool Groups](#)

Inline Tools in a Series

Tools can form an inline series, in which the traffic from one tool flows to the next, so all tools see the same traffic.

Refer to [Figure 285: Inline Tool Series](#) for an inline tool series. In [Figure 285: Inline Tool Series](#), traffic is only shown from A-to-B.

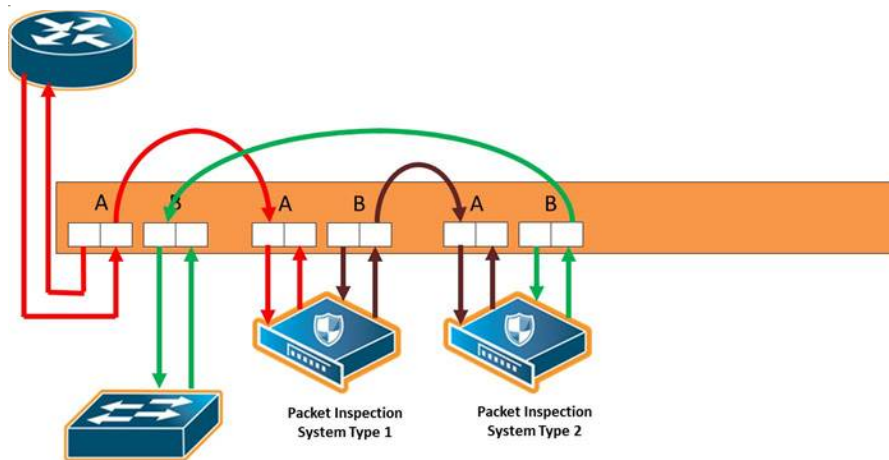


Figure 285: Inline Tool Series

For more information on inline tool series, refer to [Inline Tools in a Series](#).

Multiple Inline Networks

An inline network group is an arrangement of multiple inline networks that share the same inline tool, inline tool group, or inline tool series. The numbers of networks to tools can be many-to-one as shown in [Figure 286: Inline Network Group](#) or many-to-many. Traffic is guided to a particular inline network through internal VLAN ID tagging.

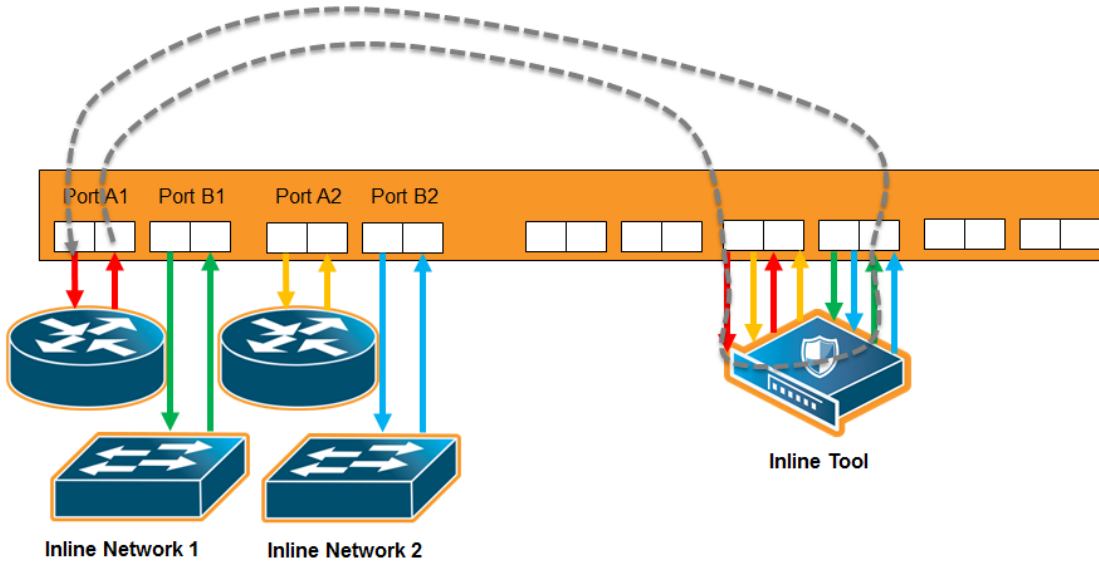


Figure 286: Inline Network Group

For more information on inline network groups, refer to [Configure Inline Bypass Solutions](#).

Inline Flow Mapping®

Some tools are optimized for particular inline traffic. With inline flow mapping, the GigaVUE node forwards packets to different inline tools based on criteria, such as TCP/UDP port number, or any other rule that can be defined in a map. Using these map rules, selected traffic can be sent to specific tools.

When inline flow mapping is combined with distribution to multiple tools, one application, such as Web traffic, can be sent to one tool or group of tools, while another application, such as email traffic, can be sent to another tool or group of tools. If there is traffic, such as encrypted traffic, that does not need to be or cannot be inspected, it can be bypassed.

An inline flow mapping based traffic distribution is shown in [Figure 287: Inline Flow Mapping® Based Traffic Distribution](#). In [Figure 287: Inline Flow Mapping® Based Traffic Distribution](#), traffic is only shown from A-to-B.

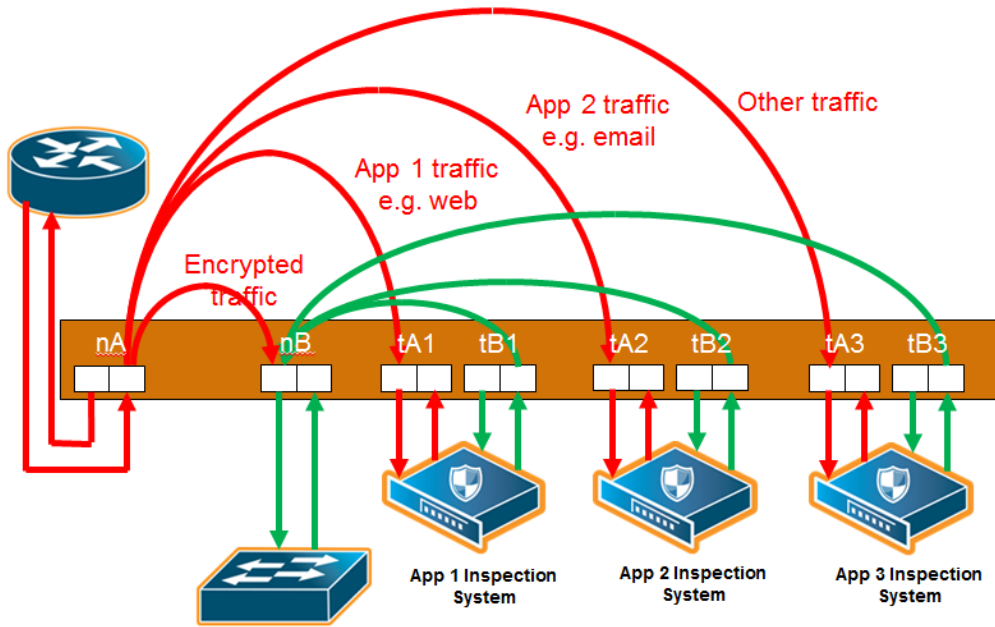


Figure 287: Inline Flow Mapping® Based Traffic Distribution

Send Traffic to Out-of-Band Tools

Traffic can be sent to out-of-band (OOB) tools. Any port used for inline functionality can be used as a source for a map to an out-of-band tool. This includes any inline network port or inline tool port. For example, you can use inline tool ports to inspect packets that have passed through the IPS.

An out-of-band arrangement is shown in [Figure 288: Out-of-Band Arrangement](#).

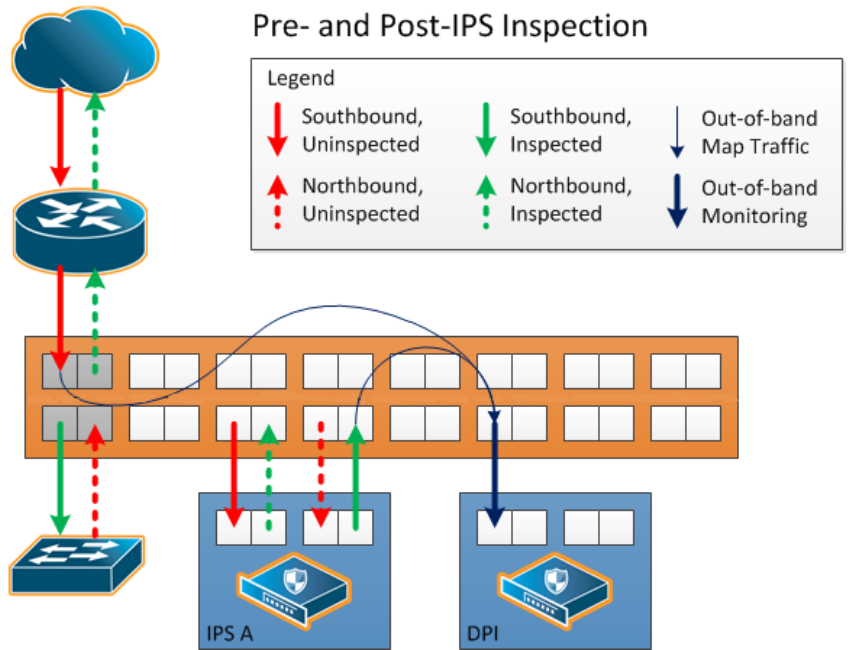


Figure 288: Out-of-Band Arrangement

Configure Inline Bypass Solutions

Inline bypass solutions are arrangements of inline networks that act to guide traffic through one or more inline tools attached to a GigaVUE node.

Configure inline bypass solutions using the following software constructs:

- Inline network

For configuring inline networks, which are pairs of network ports attached to the sides of the network, refer to [About Inline Networks](#).

- Inline network groups

For configuring inline network groups, which are multiple inline networks sharing the same inline tool or tools, refer to [About Inline Network Groups](#).

- Inline tool

For configuring inline tools, which are pairs of inline tool ports plus the inline tools attached to the ports, refer to [About Inline Tools](#).

- Heartbeat profile

For configuring monitoring of inline tools using heartbeat and/or negative heart beat packets or both, refer to [About Heartbeat Profiles](#).

- Inline tool group

For configuring multiple inline tools, which are arrangements of multiple inline tools to which traffic is distributed based on hashing, refer to [About Inline Tool Groups](#).

- Inline serial tools

For configuring inline tools in a series, in which traffic is guided through the inline tools in a serial fashion. Refer to [About Inline Serial Tools](#).

The steps to configure inline constructs are only applied to GigaVUE HC Series nodes. In a cluster environment, these steps are only applied to GigaVUE HC Series nodes through the cluster master.

The inline constructs must all be configured on one GigaVUE-HC3, GigaVUE-HC2, or one GigaVUE-HC1 node, not across nodes, even if the nodes are in a cluster.

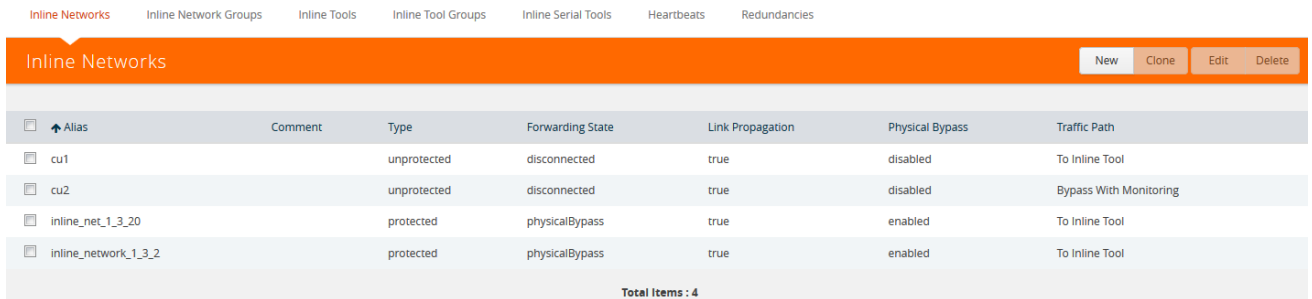
In addition to the steps listed, a map passall, map, or map shared collector is part of the configuration. For more information, refer to [Associate Inline Networks with Inline Tools Using Inline Maps](#).

For out-of-band maps, refer to [Out-of-Band \(OOB\) Map](#).

For the order in which to configure the software constructs associated with inline bypass solutions, refer to [Configuration Steps](#).

About Inline Networks

Currently configured in-line networks are displayed on the Inline Networks page, which is opened by selecting **Inline Bypass > Inline Networks**.



The screenshot shows the 'Inline Networks' page with a navigation bar at the top containing links for 'Inline Networks', 'Inline Network Groups', 'Inline Tools', 'Inline Tool Groups', 'Inline Serial Tools', 'Heartbeats', and 'Redundancies'. Below the navigation bar is a table with the following data:

<input type="checkbox"/>	Alias	Comment	Type	Forwarding State	Link Propagation	Physical Bypass	Traffic Path
<input type="checkbox"/>	cu1		unprotected	disconnected	true	disabled	To Inline Tool
<input type="checkbox"/>	cu2		unprotected	disconnected	true	disabled	Bypass With Monitoring
<input type="checkbox"/>	inline_net_1_3_20		protected	physicalBypass	true	enabled	To Inline Tool
<input type="checkbox"/>	inline_network_1_3_2		protected	physicalBypass	true	enabled	To Inline Tool

At the bottom of the table, it says 'Total Items : 4'. In the top right corner of the table area, there are buttons for 'New', 'Clone', 'Edit', and 'Delete'.

Figure 289: Summary Page of Inline Network Ports

Click **New** to open the **Inline Network** configuration page to configure an inline network, which is a pair of network ports arranged for inline monitoring. The arrangement facilitates access to a bidirectional link between the two networks (two far-end network devices) that need to be linked through an inline tool.

An inline network consists of inline network ports, always in pairs, running at the same speed, on the same medium (either fiber or copper). The inline network ports must be on the same GigaVUE-HC3, GigaVUE-HC2, or GigaVUE-HC1 node.

An inline network can be unprotected or protected. On the GigaVUE HC Series nodes, protected inline networks are implemented using bypass combo modules. Protected inline networks are based on the pairs of ports associated with physical protection switches on the bypass combo modules. The protected inline network ports provided by the bypass combo modules offer link speeds that can be configured at either 1Gb or 10Gb.

Starting in software version 5.0, the GigaVUE-HC2 with Control Card version 2 supports a 40Gb bypass combo module and starting in software 5.1.01, the GigaVUE-HC3 supports a 100Gb bypass combo module and starting in software version 5.2, the GigaVUE-HC3 100Gb bypass combo module supports dual speeds: 100Gb or 40Gb.

NOTE: You do not need to create the inline network ports for the protected port pairs on the bypass combo modules because they are created automatically when the bypass combo module initializes.

Other ports on the bypass combo module or on other line cards or modules can be designated as inline-network type ports. These ports will automatically be unprotected.

You also do not need to create the protected inline networks on the bypass combo modules because they are created automatically when the bypass combo module initializes. In addition, you cannot delete the protected inline networks on the bypass combo modules.

On GigaVUE-HC1, inline networks can also be configured on the copper TAP-HC1-G10040 module. On the GigaVUE-HC2, inline networks can be configured on the copper TAP-HC0-G100C0 module.

Once an inline network is created, it is fully configurable regardless of whether or not it is associated with an inline tool or an inline tool group through a map or map passall.

Use the Inline Networks page to display the configuration of inline networks as well as the current state of the inline bypass solution. The overall state of the inline bypass solution consists of the inline networks involved in the solution as well as the associated inline maps and inline tools. For details, refer to the following:

- [Display Current State of Inline Bypass Solution](#)
- [How to Use SNMP Polling to Obtain Inline Network State](#)
- [SNMP Notification of Forwarding State Change](#)
- [How to Use Syslog to Obtain Inline Network State](#)

For details on the parameters of inline networks, refer to the following:

- [Network Port Link Status Propagation Parameter](#)
- [Traffic Path Parameter](#)
- [Physical Bypass Parameter.](#)

Network Port Link Status Propagation Parameter

One of the parameters of inline networks is link status propagation, which controls the behavior of the link status for the inline network ports involved in a given inline network. The default is enabled.

When enabled, an inline network link failure on one side of the inline network will be propagated to the other side. For example, when the link is lost on one side of the network such that traffic cannot be sent to the inline tools, the link on the opposite side of the network is also brought down.

When the link is restored to the side that originally went down, the link will automatically be restored to the other side of the network. The GigaVUE node will not forward packets to the inline tools until the link is restored on both sides.

Link status propagation is enabled by selecting **Link Failure Propagation** when configuring an inline network port.

Traffic Path Parameter

One of the parameters of inline networks is **Traffic Path**, which specifies the path of the traffic received at an inline network port. The values are as follows:

- **Drop**—no traffic is exchanged through the inline network ports. All traffic to these ports is dropped. No traffic is forwarded to or from the inline tool or tools. No traffic is passed from inline network port A to inline network port B or from inline network port B to inline network port A. Refer to [Figure 290: Traffic Path of Drop](#).
- **ByPass**—there are two cases for bypass as follows, depending on the inline map configuration:
 - If there are no inline maps associated with the inline network or if the set of inline maps associated with the inline network guarantees that no traffic is dropped when the traffic path is set to **To Inline Tool**, then setting the traffic path to **Bypass** leads to the following: all traffic arriving at the side A inline network port is forwarded to the side B inline network port and all traffic arriving at the side B inline network port is forwarded to the side A inline network port through a logical bypass. Refer to [Figure 291: Traffic Path of Bypass](#) for a simple scenario involving a map-passall in which there is no possibility of traffic drops.
 - If the set of inline maps associated with the inline network involves some traffic drop when the traffic path is set to **To Inline Tool**, then setting the traffic path to **Bypass** leads to the following: all traffic arriving at the side A inline network port that would not have been dropped with traffic path set to **To Inline Tool** is forwarded to the side B inline network port and all traffic arriving at the side B inline network port that would not have been dropped with traffic path set to **To Inline Tool** is forwarded to the side A inline network port through a logical bypass. In other words, packets that were dropped when the traffic path was set to **To Inline Tool** will also be dropped when set to **Bypass**.

In either of these two bypass cases, no traffic is forwarded to the inline tool or tools.

- **ByPass with Monitoring**—there are two cases for monitoring as follows, depending on the inline map configuration:
 - If there are no inline maps associated with the inline network or if the set of inline maps associated with the inline network guarantees that no traffic is dropped when the traffic path is set to **To Inline Tool**, then setting the traffic path to **ByPass with Monitoring** leads to the following: all traffic is forwarded as for bypass, but a copy of the traffic is forwarded to the inline tool or tools according to the configured maps between the inline network and the inline tool or tools. Refer to [Figure 292: Traffic Path of Monitoring](#) for a simple scenario involving a map-passall in which there is no possibility of traffic drops.

- If the set of inline maps associated with the inline network involves some traffic drop when the traffic path is set to **To Inline Tool**, then setting the traffic path to **ByPass with Monitoring** leads to the following: all traffic that would not have been dropped with traffic path set to **To Inline Tool** is forwarded as for bypass, but a copy of the traffic is forwarded to the inline tool or tools according to the configured maps between the inline network and the inline tool or tools.

In either of these two monitoring cases, no traffic is taken from the inline tools.

- **To Inline Tool**—traffic received at the inline network ports is forwarded according to the following factors:
 - the configured maps between the inline network and the inline tools
 - the failover actions of the inline tool or tools
 - the health state of the inline tool or tools

Refer to [Figure 293: Traffic Path of To-Inline-Tool](#).

The default is **Bypass**. This avoids any traffic loss when first configuring an unprotected inline network or when disabling physical bypass on a protected inline network.

[Figure 290: Traffic Path of Drop](#) to [Figure 293: Traffic Path of To-Inline-Tool](#) show the traffic path for a simple inline bypass solution with inline network ports (nA and nB), inline tool ports (tA and tB), and a map passall.

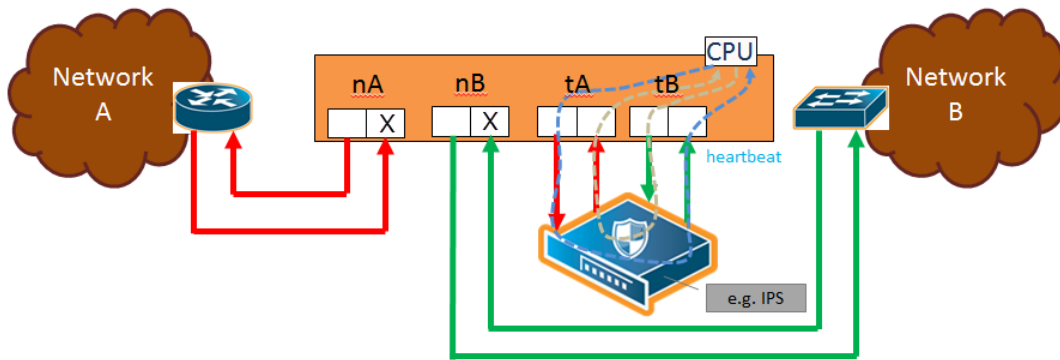


Figure 290: Traffic Path of Drop

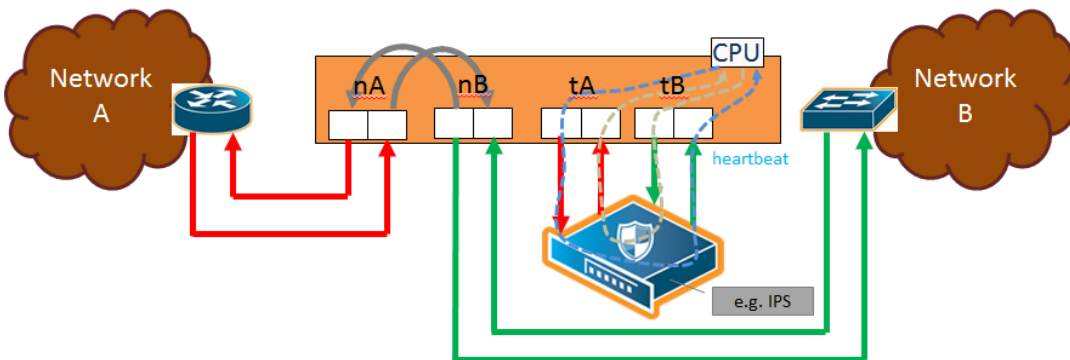


Figure 291: Traffic Path of Bypass

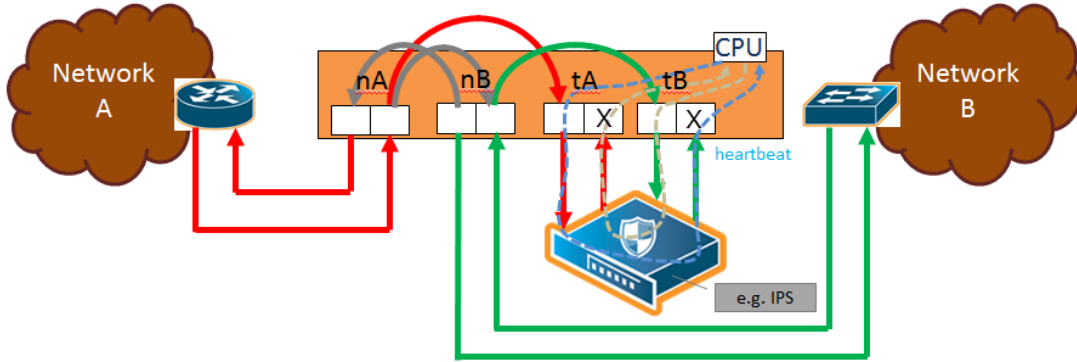


Figure 292: Traffic Path of Monitoring

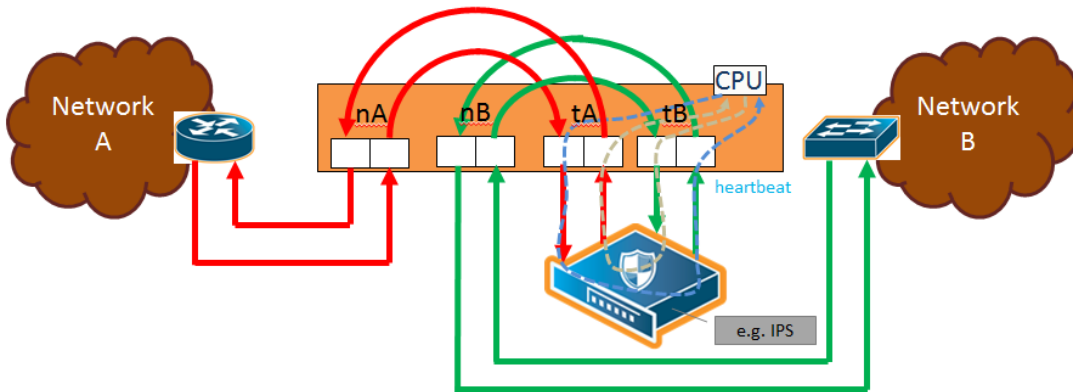


Figure 293: Traffic Path of To-Inline-Tool

Physical Bypass Parameter

One of the parameters of inline networks is physical bypass, which controls the state of the optical protection switch on the bypass combo module or copper TAP module when the module is powered on. The optical protection switch can have one of the following states:

- close—the fiber connected to the side A network port is passively coupled with the fiber connected to the side B port without any transceivers or switching fabric. Therefore, any traffic coming in on these fibers is exchanged between the two inline network ports without being noticed by the system.
- open—the fiber connected to the inline network ports is coupled through transceivers with the switching fabric that is under software control. Therefore, any traffic coming in on these fibers is subject to the traffic forwarding rules imposed by the current configuration as well as the current state of the inline tools.

When the bypass combo module or copper TAP modules is powered off, the optical protection switch is always in the close state.

When the bypass combo module or copper TAP modules is powered on, the state of the optical protection switch is as follows:

- the close state if **Physical Bypass** is set to enable (that is, selected on the configuration page)
- the open state if physical bypass is set to disable (that is, not selected on the configuration page)

Physical Bypass is enabled by default.

NOTE: Physical bypass only applies to protected inline networks.

Redundancy Profile Parameter

One of the parameters of inline networks is redundancy profile. A redundancy profile is used to configure Gigamon Resiliency for Inline Protection (GRIP). For more detailed information about GRIP, refer to the [Configure Gigamon Resiliency for Inline Protection](#).

To create a redundancy profile, do the following:

1. Select **Inline Bypass > Redundancies**.
2. Click New to open the Add Redundancy Profile page.
3. Type a name for the profile in the Alias field to help identify the profile.
4. Select a stack port by clicking the **Signaling Port** field and selecting an available port.
The Signaling Port field specifies the used to signal the state of the two GigaVUE-HC2 nodes to each other. The ports provide the mechanism to detect loss of power in one of the GigaVUE-HC2 nodes.
5. Click in the **Protection Role** field and select a role.
The protection role specifies the role of the GigaVUE-HC2, as primary, secondary, or suspended. The default is suspended. When suspended, the protection role is on hold. Changing a GigaVUE-HC2 from the primary role to the suspended role can be used to manually force one of the GigaVUE-HC2 nodes to become active. The suspended role is also used when performing maintenance.
6. Click **Save**.

To add the redundancy profile to the inline network, select the profile from the Redundancy Profile drop-down list on the Inline Network configuration page.

Display Current State of Inline Bypass Solution

Inline networks, inline tools, and inline maps work together to form an inline bypass solution. The inline bypass solution has an overall state, which can change in response to hardware conditions and user configuration.

Several factors make up the overall state of an inline bypass solution, as follows:

- The physical bypass configuration of the inline network is protected.
- The inline network configuration, in particular, if physical bypass is enabled or disabled, what traffic path is configured, and if link failure propagation is enabled or disabled.
- The inline tool configuration, in particular, if the state of the inline tool is enabled or disabled, if there is a heartbeat profile configured and if the heartbeat is enabled or disabled, and what failover actions are configured.
- The inline tool group configuration, in particular, if the state of the inline tool group is enabled or disabled, what failover mode is configured, what failover action is configured, and what number of minimum healthy tools is configured.
- The status of the links attached to the inline network ports and inline tool ports.

[Forwarding States and Determining Factors](#) describes each forwarding state and the factors determining that state.

Whenever link failure propagation is configured as false (disabled), the inline network port status reflects the status of the respective far-end ports. Only when link failure propagation is configured as true (enabled) does this behavior change. Refer to the note under the Forwarding states for DISABLED and DISCONNECTED in [Forwarding States and Determining Factors](#).

Table 55: Forwarding States and Determining Factors

physical-bypass	traffic-path	Status of far-end ports connected to inline network ports	Status of inline tool side	Description
enable	drop, bypass, monitoring, or to-inline-tool	any status	any status	Forwarding state—PHYSICAL BYPASS If physical bypass is enabled, all traffic is exchanged directly between side A network and side B network without any monitoring by the GigaVUE node. Only applies to protected inline networks.

physical-bypass	traffic-path	Status of far-end ports connected to inline network ports	Status of inline tool side	Description
disable	drop	any status	any status	<p>Forwarding state—DISABLED</p> <p>If the inline network is configured with a traffic path of drop, no traffic is exchanged between side A network and side B network because all packets coming to the inline network ports are dropped.</p> <p>NOTE: If the inline network is configured with link failure propagation set to true (enabled), the status of the inline network ports will be determined by the status of the far-end ports connected to the inline network ports. If both far-end ports are up, then both inline network ports will be up. If any far-end ports are down, then both inline network ports will be down.</p>
disable	bypass, monitoring, or to-inline-tool	at least one far-end port is down	any status	<p>Forwarding state—DISCONNECTED</p> <p>When one of the inline network ports is down due to a link down caused by a far-end device, no traffic is exchanged between side A network and side B network.</p> <p>NOTE: If the inline network is configured with link failure propagation enable as true, the status of both inline network ports will be down. That is, if only one inline network port is down, the other will be brought down.</p>
disable	bypass	both far-end ports are up	any status	<p>Forwarding state—FORCED BYPASS</p> <p>If the inline network is configured with a traffic path of bypass, all traffic that would not have been dropped when the traffic path is set to to-inline-tool is exchanged directly between side A network and side B network through the switching fabric.</p>
disable	monitoring	both far-end ports are up	any status	<p>Forwarding state—FORCED BYPASS WITH MONITORING</p> <p>If the inline network is configured with a traffic path of monitoring, all traffic that would not have been dropped when the traffic path is set to to-inline-tool is exchanged directly between</p>

physical-bypass	traffic-path	Status of far-end ports connected to inline network ports	Status of inline tool side	Description
				side A network and side B network through the switching fabric. If there is any inline map configured for the inline network, a copy of the respective traffic is directed to the respective inline tools according to the configured inline maps.
disable	to-inline-tool	both far-end ports are up	all inline tools involved in the inline bypass solution are operating as expected	Forwarding state—NORMAL If all inline tools involved in the inline bypass solution are enabled, all inline tool ports are up, and the inline tools operating with heartbeat protocol enabled have a heartbeat status of up, traffic flows as desired according to the configuration of the inline maps.
disable	to-inline-tool	both far-end ports are up	at least one inline tool involved in the inline bypass solution is disabled or associated with any inline tool port that is down or associated with the heartbeat protocol in a down state	Forwarding state—FAILURE-INTRODUCED BYPASS All traffic is exchanged directly between side A network and side B network through the switching fabric as a result of an inline tool port failure or heartbeat failure or inline tool being disabled that led to the network-level bypass due to the configured failover actions.
disable	to-inline-tool	both far-end ports are up	at least one inline tool involved in the inline bypass solution is disabled or associated with any inline tool port that is down or associated with the heartbeat protocol in a down state	Forwarding state—FAILURE-INTRODUCED DROP No traffic is exchanged between side A network and side B network. All packets coming to the inline network ports are dropped as a result of an inline tool port failure or heartbeat failure or inline tool being disabled that led to the network-level drop due to the configured failover actions.
disable	to-inline-tool	both far-end ports are up	at least one inline tool involved in	Forwarding state—NETWORK PORTS FORCED DOWN

physical-bypass	traffic-path	Status of far-end ports connected to inline network ports	Status of inline tool side	Description
			the inline bypass solution is disabled or associated with any inline tool port that is down or associated with the heartbeat protocol in a down state	No traffic is exchanged between side A network and side B network. The inline network ports are forced down as a result of an inline tool port failure or heartbeat failure or inline tool being disabled that led to the network ports being forced down due to the configured failover actions.
disable	to-inline-tool	both far-end ports are up	at least one inline tool involved in the inline bypass solution is disabled or associated with any inline tool port that is down or associated with the heartbeat protocol in a down state	Forwarding state—ABNORMAL Any condition of the inline bypass solution that does not meet the criteria of the forwarding states listed in this table. At least one inline tool passes traffic as desired. There are many scenarios that can lead to the abnormal forwarding state, for example, when one inline tool member of an inline tool group has failed, but the number of remaining healthy tools is still above the minimum required number of healthy tools.

How to Use SNMP Polling to Obtain Inline Network State

The overall inline network state can also be obtained through SNMP polling using an SNMP-compliant network management application or a MIB browser. The names of the MIB files that need to be loaded in order to poll the inline network state are: GIGAMON-COMMON-SMI and GIGAMONINLINEBYPASS.

The inline network forwarding states are described in [Forwarding States and Determining Factors](#). Some of the states have slightly different names in SNMP.

SNMP Notification of Forwarding State Change

Use the following steps to configure a notification that will be sent when the inline bypass forwarding state changes:

1. Select **Settings > SNMP Traps**.
2. Click **Trap Settings**. The Edit SNMP Trap Settings page displays.

3. On the Edit SNMP Trap Settings page, select **Enable** for **Inline Bypass Forwarding State Change**.
4. Click **Save**.

How to Use Syslog to Obtain Inline Network State

The overall inline network state can also be obtained through syslog.

When the inline network state change is triggered by a configuration change, a sample syslog message is as follows:

```
IBFE STATE CHANGE inline network default_inline_net_1_1_1 status NORMAL
changed to PHYSICAL BYPASS triggered by config
```

When the inline network state change is triggered by a link status change or heartbeat status change, a sample syslog message is as follows:

```
IBFE STATE CHANGE inline network inNet1 status NORMAL changed to FAILURE
INTRODUCED BYPASS triggered by 1/x10
```

In the syslog messages, IBFE indicates the Inline Bypass Failover Engine.

The inline network forwarding states are described in [Forwarding States and Determining Factors](#).

About Inline Network Groups

Use the **Inline Network Group** configuration page to configure an inline network group. An inline network group is an arrangement of multiple inline networks that share the same inline tool or tools. Use this page to specify the list of inline networks in the inline network group.

The inline network ports that make up the inline networks participating in the inline network group are always in pairs, running at the same speed, on the same medium (fiber or copper). All inline network ports of the inline network group must be on the same GigaVUE-HC3, GigaVUE-HC2, or GigaVUE-HC1 node. The inline networks participating in the inline network group can be different speeds and different mediums.

An inline network group can share an inline tool, or tools in an inline tool group or inline tool series. Many-to-one means from an inline network group to an inline tool and is shown in [Figure 294: Inline Network Group Many-to-One](#). Many-to-many means from an inline network group to an inline tool group or inline tool series.

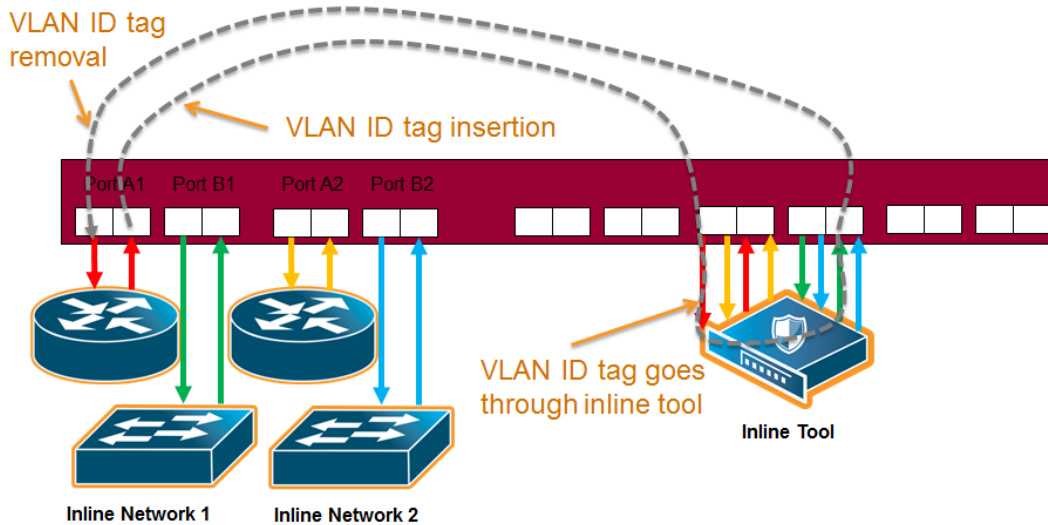


Figure 294: Inline Network Group Many-to-One

When an inline tool or inline tool group is configured between several pairs of networks, each pair operates independently of the others. The traffic coming from the inline tool or tools must be segregated into individual substreams according to the traffic source.

For example, the traffic that came into the GigaVUE node on inline network port net_A_3 must be sent through inline network port net_B_3 (with net_A_3 and net_B_3 belonging to the same inline tool that is the third member of the inline tool group). Refer to [Figure 295: Inline Tool Inserted in Multiple NetA-NetB Links](#).



Figure 295: Inline Tool Inserted in Multiple NetA-NetB Links

To accomplish the segregation, packets are tagged coming from an individual side A inline network port before they are sent to the inline tool or tools. When tagged packets come back from the inline tool or tools, the tag identifies the respective side B inline network port through which the packets should be sent. The tags are removed before the packets are sent through the side B inline network ports.

Traffic is guided to a particular inline network through internal VLAN ID tagging. This VLAN tagging affects packets only on their way from inline tool ports to the attached inline tool and back from the attached inline tool to the inline tool ports. The packets sent out from inline network ports remain untagged. Refer to [Figure 294: Inline Network Group Many-to-One](#).

NOTE: Internal VLAN ID tagging creates hidden VLAN ID tags. Explicit VLAN ID tagging is not needed, however starting in software version 4.6, explicit VLAN tagging is also available. Refer to [Configurable VLAN Tagging](#).

Inline Tool Sharing

Inline network groups require inline tool sharing to be enabled on the inline tool or the members of the inline tool group or inline tool series specified in the inline map.

When shared is enabled (true), the inline tool can receive traffic from multiple sources (the inline networks in the inline network group) and can be used in a map in which the source is an inline network group.

An inline tool group or inline series does not have its own shared setting. The shared setting is derived from the inline tools. Therefore all the members in an inline tool group or inline series must have the same setting. For example, if an inline tool group has three inline tool members, the shared setting of all three inline tools must be the same.

Configurable VLAN Tagging

Explicit VLAN tagging for inline network groups can be configured. For example, you can use VLAN tags for managing policies. A mixture of internal and explicit VLAN tags is supported.

The VLAN tags are configured on the ports of inline networks. They can be configured at any time, but are only applied when the inline networks are part of an inline network group. Across the inline network group, the VLAN tags must be unique; however, both ports of an inline network can have the same VLAN tag. Refer to [Tools in Bridge Mode](#).

An error message is displayed if the same VLAN tag is used for more than one inline network in an inline network group.

Refer also to [Ingress and Egress VLAN](#).

NOTE: For inline SSL decryption, the inline network group does not support ingress VLAN tagging on the member links.

For out-of-band maps from inline network group ports or inline tool ports mapped from an inline network group, the out-of-band tool ports will receive the following:

- tagged packets, if they originally come from an inline network port with an ingress VLAN tag configured
- untagged packets, if they originally come from an inline network port without an ingress VLAN tag configured

Add VLAN Tag

The following are the steps for adding a VLAN Tag.

1. Select **Ports > All Ports**.
2. Select the port to configure as an inline network port and click Edit.
3. Set the following parameters to configure an inline network port with VLAN tagging:
 - Select **Inline Network** or **Network** for Type.
 - Enter a VLAN ID in the **VLAN Tag** field.
4. Click **Save**.

Tools in Bridge Mode

The same VLAN tag can be assigned to both ports in an inline network port pair.

The following example configures the same ingress port VLAN tag on the net-a and net-b ports of an inline network. When the net-a and net-b ports have the same VLAN tag, an inline tool will send packets back to the network from which it came.

1. Select **Ports > All Ports**.
2. Configure the net-a port.
 - a. Select the port (for example, 1/1/x17) and click **Edit**.
 - b. Enter inline-network-port-a in the **Alias** field.
 - c. Select **Inline Network** for **Type**.
 - d. Enter 123 in the VLAN Tag field.
 - e. Click **Save**.
3. Configure the net-b port.
 - a. Select the port (for example, 1/1/x18) and click **Edit**.
 - b. Enter inline-network-port-a in the **Alias** field.
 - c. Select **Inline Network** for **Type**.
 - d. Enter 123 in the VLAN Tag field.
 - e. Click **Save**.

4. Configure the Inline Network.
 - a. Select Inline **Bypass > Inline Networks**.
 - b. Click **New**.
 - c. Enter an alias in the **Alias** field.
 - d. Select port 1/1/x17 for Port A.
 - e. Select port 1/1/x18 for Port B.
 - f. Click Save.

About Inline Tools

There are two meanings to the term inline tool. The inline tool software construct consists of a pair of inline tool ports plus the inline tool attached to the ports. The software construct has attributes that are configured on the GigaVUE HC Series node.

The term inline tool also refers to the pass-through device itself that performs packet inspection and selective forwarding, such as an Intrusion Protection System (IPS). This is a physical device, external to the GigaVUE node.

Use the Inline Tool page to configure the inline tool software construct. An inline tool consists of inline tool ports, always in pairs, running at the same speed, on the same medium (fiber or copper). The inline tool ports must be on the same GigaVUE-HC3, GigaVUE-HC2, or GigaVUE-HC1 node. The inline tool ports must also be on the same GigaVUE-HC3, GigaVUE-HC2, or GigaVUE-HC1 node as the inline network ports.

Inline tool ports are ports to which inline tools are attached. Inline tool ports are always in pairs, and must have the same line rate. Inline tool ports must be on the same GigaVUE-HC2 or GigaVUE-HC1 node as the inline network ports.

An inline tool consists of a pair of inline tool ports plus the inline tool attached to the ports. Refer to [Figure 296: Inline Tool and Inline Tool Ports](#).

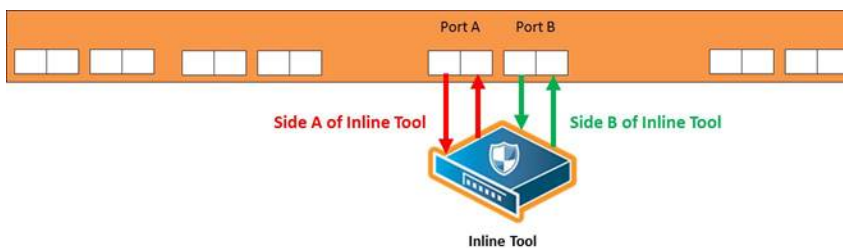


Fig. 3 Inline Tool

Figure 296: Inline Tool and Inline Tool Ports

Use the Inline Tools page to display of configuration of inline tools.

Inline Tool Failover Action

One of the parameters of inline tools is failover action, which controls the action taken when a tool is unhealthy or in response to a failure of an inline tool. You can configure one of the following failover actions:

- **ToolBypass**—when the inline tool fails, the traffic that normally was directed to the inline tool is redirected to the bypass path. Use this failover action for configurations involving multiple inline tools associated with an inline network or inline network group using rule-based maps. For configurations using map passalls, tool-bypass is the same as network-bypass.
- **NetworkBypass**—when the inline tool fails, all traffic that would not have been dropped when the inline network or networks had a NORMAL forwarding state is directed to the bypass path. That is, all such traffic arriving at the side A inline network port or ports is forwarded to the side B inline network port or ports and all traffic arriving at the side B inline network port or ports is forwarded to the side A inline network port or ports.
- **ToolDrop**—when the inline tool fails, the traffic that normally was directed to the inline tool is dropped. Use this failover action for configurations involving multiple inline tools associated with an inline network or inline network group using rule-based maps. For configurations using map passalls, tool-drop is the same as network-drop.
- **NetworkDrop**—when the inline tool fails, all traffic coming to the respective inline network (or inline network group) is dropped.
- **NetworkPortForcedDown**—when the inline tool fails, the inline network ports of the respective inline network (or inline network group) are forced down.

NOTE: However, after the device reload, the inline network ports become operationally up, whereas the inline tool is still down. You need to manually force down the inline network ports.

The default is **ToolBypass**.

The bypass path is between side A and side B of the inline network ports.

Inline Tool Failover Action with Inline Flow Mapping®

When the inline bypass solution uses inline flow mapping, the failover actions of inline tools are as follows:

- **ToolBypass**—when the inline tool fails, the traffic that normally was directed to the inline tool is redirected to the bypass path. The traffic going to the healthy inline tools (through rule-based maps) remains unchanged.

- **ToolDrop**—when the inline tool fails, the traffic that normally was directed to the inline tool is dropped. The traffic going to the healthy inline tools (through rule-based maps) remains unchanged.

Inline Tool Recovery Mode

An inline tool detects failures in the traffic path between port pairs and automatically diverts traffic away to avoid disruption. After an inline tool goes down, the following modes specify how to bring it back up after it has recovered:

- **automatic**—Specifies automatic recovery, which redirects traffic back to the inline tool as soon as it has recovered from all faulty conditions.
- **manual**—Specifies manual recovery, which lets you control when to put an inline tool back into service after the tool has recovered. For example, you may wait for a maintenance window to return the inline tool to service.

The default is automatic.

By selecting the tool and selecting the Recover button, users can set the recovery of the inline tools to manual or automatic.

Refer to [Figure 297: Automatic and Manual Inline Tool Recovery from Failover](#) for automatic and manual inline tool recovery from failover.

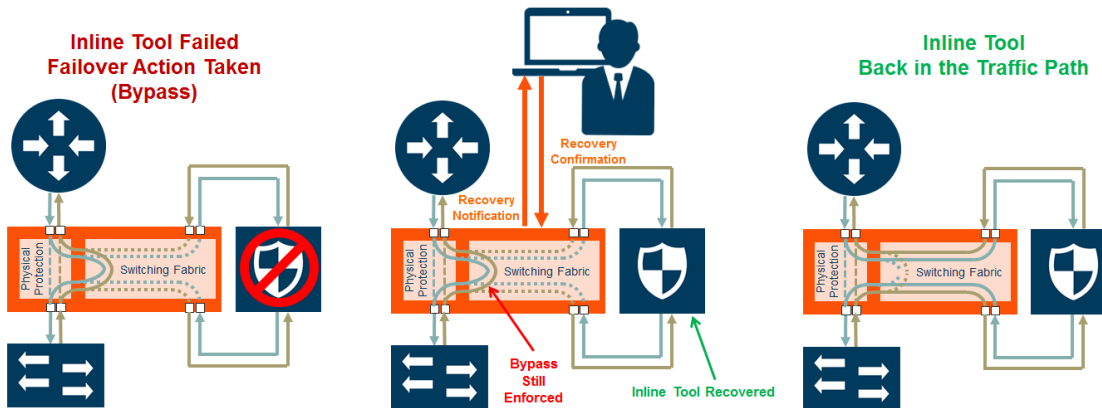


Figure 297: Automatic and Manual Inline Tool Recovery from Failover

The left side of [Figure 297: Automatic and Manual Inline Tool Recovery from Failover](#) shows an inline tool that has failed and the bypass failover action has been executed.

Automatic recovery is shown on the right side of [Figure 297: Automatic and Manual Inline Tool Recovery from Failover](#). When the inline tool recovers, traffic is automatically directed back to it.

Manual recovery is shown in the center of [Figure 297: Automatic and Manual Inline Tool Recovery from Failover](#). When the recovery mode is configured as manual, an SNMP notification, if enabled, will send a notification when the inline tool is ready to be put back into service. The failover action, in this case, bypass, will be enforced until you manually put the inline tool back into service.

When the recovery mode is configured as manual, an SNMP notification, when enabled, will notify you when the inline tool is ready to be put back into service.

Use the following steps to configure notification that will be sent when the inline tool is ready:

1. Select **Settings > SNMP Traps**.
2. Click **Trap Settings**. The Edit SNMP Trap Settings page displays.
3. On the Edit SNMP Trap Settings page, select **Enable** for **Inlinetool Recovery**.
4. Click **Save**.

The default for **Inlinetool Recovery** is disabled.

Use the following steps to put an inline back in service when the recovery mode is manual and the inline tool has an operational state of ready.

1. Select Inline **Bypass > Inline Tools**.
2. On the Inline Tools page, select the inline tool.
3. Click **Recover**.

NOTE: Also use **Recover** after the GigaVUE HC Series node is reloaded or rebooted (even though the inline tool has not failed). Issue the **Recover** on all the inline tools that are configured with manual recovery after a reload or **Actions > Shut Down** from the Chassis page on a selected card in Chassis Table View followed by **Actions > Start Up**. Refer to the "Chassis" section in the *GigaVUE-OS and GigaVUE-FM Administration Guide* for more details.

NOTE: In certain circumstances while using classic inline, if the recovery mode is set to "manual" and the inline-tool is in "ready" state, traffic may still be forwarded to the inline-tool ports. This occurs because the recovery state shifts from "ready" to "up" when "inline-tool disable/enable" is used. When the recovery mode for the inline-tool is "manual" and is in "ready" state, do not disable/enable the inline-tool. Instead, disable/enable the port.

The **Inline Tool** page displays the operational state of each inline tool as up, down, disable, or ready. Refer to [Aggregate Inline Tool States](#) for detailed descriptions of the states.

Inline Tool Sharing Mode

Inline tool sharing mode specifies how an inline tool is going to be shared as follows:

- **Enable**—Specifies that the inline tool is going to be shared by different sources.
- **Not enabled**—Specifies that the inline tool will not be shared by different sources.

The default is **not enabled**.

When sharing is enabled, the inline tool can receive traffic from multiple sources (the inline networks in the inline network group) and can be used in a map in which the source is an inline network group.

An inline tool group or inline series does not have its own shared setting. The shared setting is derived from the inline tools. Therefore all the members in an inline tool group or inline series must have the same setting. For example, if an inline tool group has three inline tool members, the shared setting of all three inline tools must be the same.

When an inline tool has sharing mode enabled, the traffic will be VLAN tagged. The connected inline device is expected to receive VLAN tagged packets. When an inline tool does not have sharing mode enabled, the extra VLAN tag is not added.

Go to **Inline Bypass > Inline Tools** and select an inline tool or click **New**. Under Configuration, Inline tool sharing mode, select Enable.

How to Use SNMP Polling to Obtain Inline Tool State

The inline tool state can also be obtained through SNMP polling using an SNMP-compliant network management application or a MIB browser. The names of the MIB files that need to be loaded in order to poll the inline tool state are: GIGAMON-COMMON-SMI and GIGAMONINLINEBYPASS.

The inline tool states are described in [Table 56: Aggregate Inline Tool States](#). They are an aggregate of the inline tool port statuses and the heartbeat status.

Table 56: Aggregate Inline Tool States

Status	Description
up	The heartbeat is up and all the inline tool ports are up. The inline tool is operational and is forwarding traffic to the tool.
down	Either the heartbeat is down or one or more of the inline tool ports are down or disabled. The inline tool is in a failed state and is not ready to recover. The tool is not receiving any traffic.

Status	Description
disable	The inline tool is disabled.
ready	The inline tool is in a failed state but is ready to recover. The tool is not receiving any traffic.

About Heartbeat Profiles

When heartbeat packets are sent to an inline tool, they are expected to be received back when the inline tool is healthy. Negative heartbeat packets complement heartbeat packets to verify the health of inline tools. When negative heartbeat packets are sent to an inline tool, they are not expected to be received back when the inline tool is healthy.

When some inline tools begin to fail, they allow packets through that should have been dropped. A negative heartbeat detects such a failure by sending a packet that should not pass through an inline tool. If the negative heartbeat packet passes through an inline tool, the tool is deemed to have failed. Therefore, a negative heartbeat packet received back from an inline tool indicates a tool failure.

Heartbeat packets and negative heartbeat packets can be used in any combination: heartbeat only, negative heartbeat only, neither, or both.

Heartbeat Profiles

A heartbeat profile supports health monitoring of inline tools. A heartbeat profile is a group of attributes applied to an inline tool to configure its heartbeat operation. Multiple inline tools can share a heartbeat profile.

To display the configured heartbeat profiles, select Inline Bypass > Heartbeats to open the Heartbeats page. An example is shown in [Figure 298: Heartbeats Page with Heartbeat Profiles](#).

<input type="checkbox"/>	Alias	Type	Packet Format	Custom Packet	Direction	Period (ms)	Timeout (ms)	Recover Time (sec)	Retries
<input type="checkbox"/>	default	regular	arp	N/A	Bi-Directional	1000	500	30	3
<input type="checkbox"/>	hb1	regular	arp	N/A	Bi-Directional	1000	500	30	3
<input type="checkbox"/>	hb_AtoB	regular	arp	N/A	A to B	500	300	15	3
<input type="checkbox"/>	hb_BtoA	regular	arp	N/A	A to B	500	300	15	3
<input type="checkbox"/>	hb_custom_med_freq	regular	arp	N/A	Bi-Directional	500	300	15	3
<input type="checkbox"/>	hb_high_freq	regular	arp	N/A	Bi-Directional	30	20	5	0
<input type="checkbox"/>	hb_high_freq_custom	regular	custom	http://10.115.0.100/ftpbboot/swapna/SICMPv6Packets.pcap	Bi-Directional	30	20	5	0

Figure 298: Heartbeats Page with Heartbeat Profiles

The Heartbeats page includes a default heartbeat profile that has the following settings:

- Alias—default
- Type—Regular
- Packet Format—arp
- Direction—bi-directional
- Period—1000 milliseconds
- Timeout—500 milliseconds
- Recovery Period—30 seconds
- Retries—3

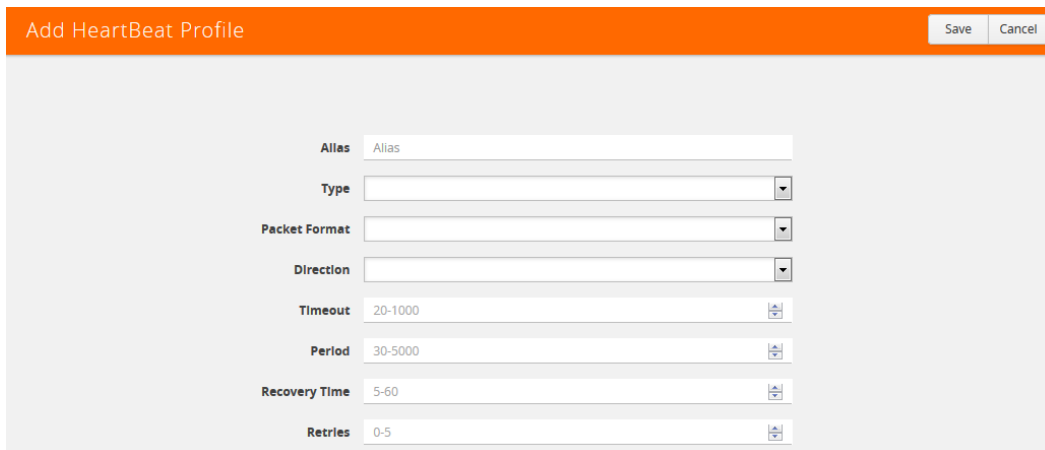
The highest frequency heartbeat that can be configured is as follows:

- period—30 milliseconds
- timeout—20 milliseconds
- retry-count—0

The heartbeat mechanism supports the maximum number of inline tools, at the highest frequency, which is 48 on the GigaVUE-HC3 and GigaVUE-HC2, and 16 on the GigaVUE-HC1.

To display the heartbeat profile associated with an inline tool and the heartbeat status, open the Inline Tools page by selecting Inline **Bypass > Inline Tools**. There is also a combined heartbeat status, which combines heartbeat and negative heartbeat statuses and indicates the tool health used for inline tool failover actions or SNMP traps. The combined heartbeat status is the combination of both heartbeat statuses. If both are configured and one is down, the combined status will be down.

Use the **Add Heartbeats** page shown in [Figure 299: Configured Heartbeat Profile for Inline Tool](#) to configure a heartbeat or negative heartbeat profile by selecting Inline Bypass > Heartbeats > Heartbeats, and then clicking New.



The screenshot shows the 'Add HeartBeat Profile' configuration page. The page has an orange header with the title 'Add HeartBeat Profile' and 'Save' and 'Cancel' buttons. The form contains several fields:

- Alias:** Text input field with the value 'Alias'.
- Type:** Dropdown menu.
- Packet Format:** Dropdown menu.
- Direction:** Dropdown menu.
- Timeout:** Text input field with the value '20-1000' and a range icon.
- Period:** Text input field with the value '30-5000' and a range icon.
- Recovery Time:** Text input field with the value '5-60' and a range icon.
- Retries:** Text input field with the value '0-5' and a range icon.

Figure 299: Configured Heartbeat Profile for Inline Tool

Statistics about heartbeat profiles are displayed on the heartbeats statistics page. To open the Statistics page, select **Inline Bypass > Heartbeats > Statistics**. The page shows the following information:

Column	Description
Heartbeat Profile	The alias of the heartbeat profile
Inline Tool Alias	The alias of the inline tool to which the heartbeat profile is related.
Type	Indicates the type of heartbeat profile: Regular or Negative
A to B Packets	The number of packets sent/received from port A to port B of the inline tool.
B to A Packets	The number of packets sent/received from port B to port A of the inline tool.

You can clear the statistics for a specific heartbeat profile or all heartbeat profile. To clear a single heartbeat profile,

1. select the profile in the Heartbeat profile column.
2. Click **Clear**.

To clear the statistics for all heartbeat profiles, do the following:

1. Select **Clear All**.
2. Choose one of the following from the menu:
 - Select **Clear All Heartbeat Stats** to clear all statistics for all heartbeat profiles.
 - Select **Clear All Negative Heartbeat Stats** to clear only the statistics for negative heart profiles. The statistics for regular heartbeat profiles will remain.

For details on the parameters of heartbeat profiles, refer to the following:

- [Standard Heartbeat](#)
- [Standard or Custom Heartbeat Packet](#)
- [Detect Inline Tool Failure](#).

Standard Heartbeat

The standard heartbeat is a packet sent by the GigaVUE node that passes through the inline tool to verify that it is passing traffic, even if the link is *up*. If the packet is not passed through the tool, the tool is considered to have failed and a bypass action is triggered.

Even when the tool is considered down, heartbeat packets continue to be sent so that the bypass action can be reversed when the tool is healthy again.

Heartbeats are sent bidirectionally to the inline tool.

Standard or Custom Heartbeat Packet

The format of the heartbeat packet can be the standard ARP packet or a custom packet. For a custom packet, you must provide a URL from which a PCAP file can be imported. If the PCAP file contains several packets, the first packet present in the file is taken as the heartbeat packet. The size of a custom heartbeat packet must be less than 128 bytes.

NOTE: The system will overwrite the MAC address portion of the custom heartbeat packet.

If the inline tool through which the heartbeat packets are passed is expecting IPv6 traffic exclusively, you must select a custom heartbeat packet.

Custom heartbeat packets are needed in situations in which inline tools do not reliably pass standard ARP packets. For example, if an inline tool is configured to pass only IPv6 traffic, an ICMPv6 ARP packet might be appropriate.

If a custom heartbeat packet is specified, the **Heartbeats** page displays the name of the PCAP file from which it was imported.

Detect Inline Tool Failure

The health of the inline tool is critical to the proper handling of traffic. An inline tool is determined to have failed if:

- link is lost to the tool
- inline heartbeat fails

When the tool fails in one direction, it is considered to have failed in both directions. For example, if the heartbeat stops flowing in the northbound direction, neither northbound or southbound packets are sent to the tool.

Negative Heartbeat Profiles

A negative heartbeat profile is a group of attributes applied to an inline tool to configure its negative heartbeat operation. Multiple inline tools can share a negative heartbeat profile. The content of a negative heartbeat is configurable using the same PCAP file mechanism as for a custom heartbeat packet.

Use the **Add Heartbeats** page shown in [Figure 299: Configured Heartbeat Profile for Inline Tool](#) to configure a negative heartbeat profile. A negative heartbeat profile can be created by selecting **Negative** in the **Type** field. The profile will have the following settings:

- **Packet Format** set to **Custom**
- **Direction** set to **Bi-directional**
- **Period** set to **1000** (period is specified in milliseconds)
- **Recover Time** set to **30** (recovery is set in seconds)

You must provide a valid PCAP file when Packet Format is set to Custom before the negative heartbeat profile can be applied to an inline tool.

When a negative heartbeat is configured, the system will send packets specified by the **Custom Packet Format**, in the time specified by **Period**, in the direction specified by **Direction**. The inline tool absorbs the negative heartbeat packets until the number of seconds specified by **Recovery Time** has passed. **Recovery Time** specifies the number of seconds of not receiving negative heartbeat packets in order for the inline tool to be declared healthy.

The negative heartbeat mechanism supports the maximum number of inline tools, which is 48 on the GigaVUE-HC3 and GigaVUE-HC2, and 16 on the GigaVUE-HC1.

Use the Heartbeat page to display the configured negative heartbeat profiles. Use the Inline Tool page to display the negative heartbeat profile associated with an inline tool, the negative heartbeat status, and the counters of received packets in each direction. There is also a combined heartbeat status, which combines heartbeat and negative heartbeat statuses and indicates the tool health used for inline tool failover actions or SNMP polling. The combined heartbeat status is the combination of both heartbeat statuses. For example, if both are enabled and both are up, the combined status is up. If both are enabled and one is down, the combined status is down.

Heartbeat Status after System Reload

Following a reload, there is a 5-minute delay for the system to stabilize before heartbeat packets are sent or received. During this delay, the heartbeat status is down.

About Inline Tool Groups

Use the **Inline Tool Groups** configuration page to configure an inline tool group, which is an arrangement of multiple inline tools to which traffic is distributed based on hashing. In an inline tool group, traffic is shared. Each inline tool in the group receives a portion of the traffic. The distribution mechanism includes a way of dealing with failures of individual tools through traffic redistribution to the remaining healthy tools.

The inline tool ports that make up the inline tools participating in the inline tool group are always in pairs, running at the same speed, on the same medium (fiber or copper). All inline tool ports of the inline tool group must be on the same GigaVUE-HC3, GigaVUE-HC2, or GigaVUE-HC1 node, but can be on different modules on the node. The inline tool ports must also be on the same GigaVUE-HC3, GigaVUE-HC2, or GigaVUE-HC1 node as the inline network ports.

Inline tool groups can be configured as follows:

- non-redundant—multiple inline tools with no spare inline tool. Refer to [Figure 300: Inline Tool Group With No Spare, Non-Redundant](#).
- 1+1 redundancy—single inline tool with a spare inline tool. Refer to [Figure 301: Inline Tool Group With Spare, Redundant 1+1 Scenario](#).
- N+1 redundancy—multiple inline tools that are considered active, with a standby inline tool that is only used if one of the active inline tools fails. Refer to [Figure 302: Inline Tool Group With Spare, Redundant N+1 Scenario](#).

With 1+1 redundancy, an inline tool is paired with a standby tool. When there is a loss of link or a heartbeat failure on an active tool, the traffic will be sent to the standby tool with no loss. In addition, if the standby tool fails, you can configure what happens to the traffic in that case, such as drop it or forward it.

With N+1 redundancy, one tool is added to a group of N distributed inline tools. When any one of the N tools fails, the traffic from that tool is sent to the standby (or spare) tool with no loss. In addition, if the standby tool fails, you can configure what happens to the traffic in that case, such as redistribute it, send it to another tool, or declare a failure on the tool group.

Refer to [Figure 300: Inline Tool Group With No Spare, Non-Redundant](#) for a non-redundant inline tool group.

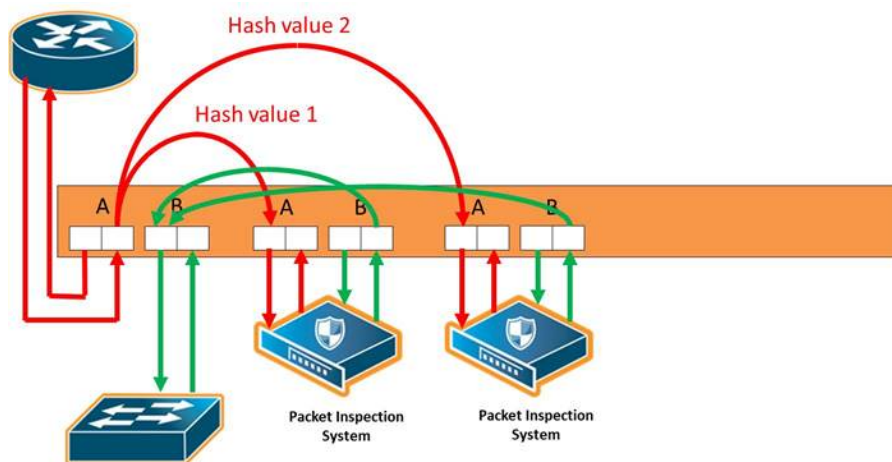


Fig.4 Inline-Tool-Group no-spare-tool scenario
(Only A-to-B traffic shown for diagram clarity)

Figure 300: Inline Tool Group With No Spare, Non-Redundant

Refer to Figure 301: Inline Tool Group With Spare, Redundant 1+1 Scenario for an inline tool group with a single inline tool and a spare inline tool configured. This is also referred to as 1+1 redundancy or N+1 redundancy where N equals 1. In Figure 301: Inline Tool Group With Spare, Redundant 1+1 Scenario, traffic is only shown from A-to-B.

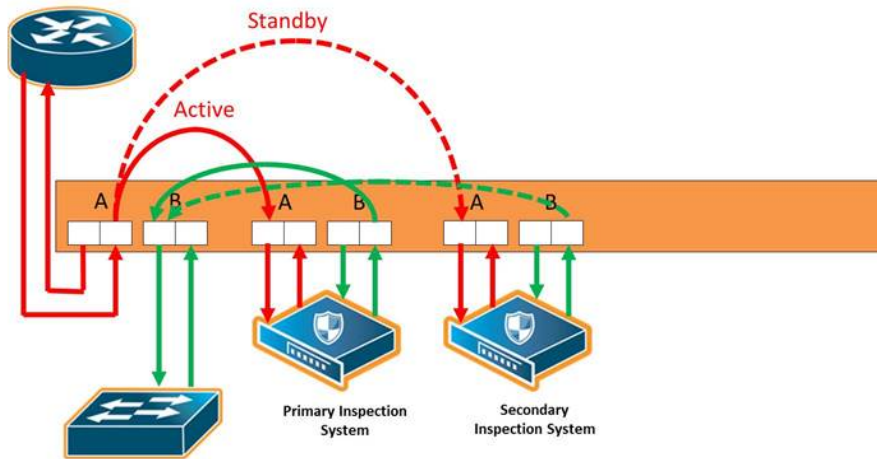


Figure 301: Inline Tool Group With Spare, Redundant 1+1 Scenario

Refer to Figure 302: Inline Tool Group With Spare, Redundant N+1 Scenario for an inline tool group in an N+1 redundant scenario, in which N is greater than 1. In Figure 302: Inline Tool Group With Spare, Redundant N+1 Scenario, traffic is only shown from A-to-B.

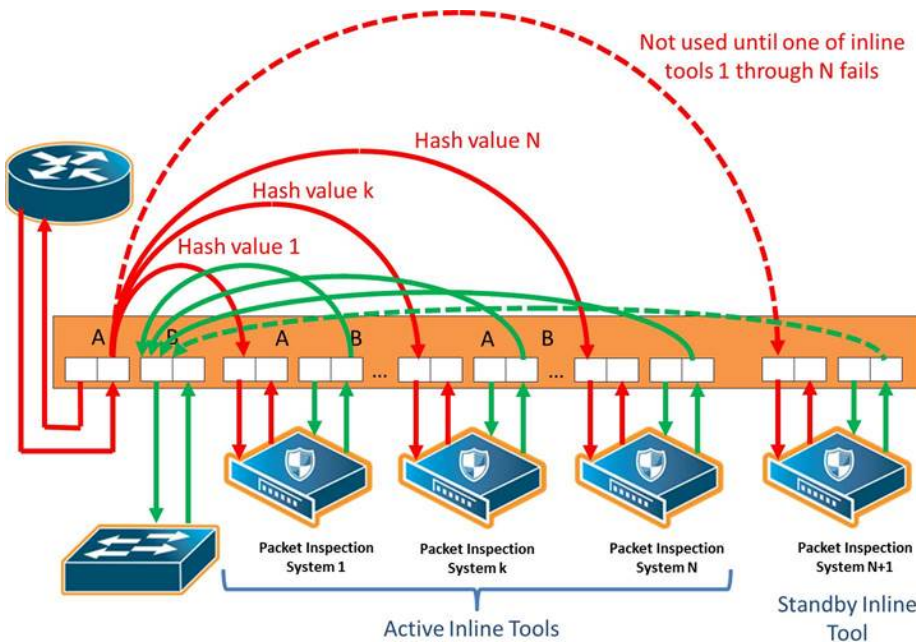


Figure 302: Inline Tool Group With Spare, Redundant N+1 Scenario

For details on the parameters of inline tool groups, refer to the following:

- [Inline Tool Group Failover Action](#)
- [Inline Tool Group Spare Inline Tool](#)
- [Symmetrical and Asymmetrical Hashing](#).
- [Resilient Weighted Hashing](#)

Inline Tool Group Failover Action

One of the parameters of inline tool groups is the failover action, taken in response to a failure of an inline tool group, when the number of healthy inline tools in the inline tool group (including the spare inline tool, if configured) falls below the configured minimum. You can configure one of the following failover actions:

- **ToolBypass**—when the inline tool group fails, the traffic that normally was directed to the inline tool group is redirected to the bypass path. Use this failover action for configurations involving multiple inline tools or inline tool groups associated with an inline network or inline network group using rule-based maps. For configurations using map passalls, tool-bypass is the same as network-bypass.
- **NetworkBypass**—when the inline tool group fails, all traffic that would not have been dropped when the inline network or networks had a NORMAL forwarding state is directed to the bypass path. That is, all such traffic arriving at the side A inline network port or ports is forwarded to the side B inline network port or ports and all traffic arriving at the side B inline network port or ports is forwarded to the side A inline network port or ports.
- **NetworkPortForcedDown**—when the inline tool group fails, the inline network ports of the respective inline network (or inline network group) are forced down.
- **ToolDrop**—when the inline tool group fails, the traffic that normally was directed to the inline tool group is dropped. Use this failover action for configurations involving multiple inline tools or inline tool groups associated with an inline network or inline network group using rule-based maps. For configurations using map passalls, tool-drop is the same as network-drop.
- **NetworkDrop**—when the inline tool group fails, all traffic coming to the respective inline network (or inline network group) is dropped.

The default is tool-bypass.

The bypass path is between side A and side B of the inline network ports.

The failover action of all the inline tools specified by the inline tool list is overwritten by the failover mechanism of the inline tool group. This means that when a given inline tool specified by the inline tool list fails, the traffic originally directed to this inline tool is redirected to the spare inline tool (if

one is configured and available) or handled according to the failover mode of the active tools, so long as the total number of healthy inline tools in the inline tool group is not smaller than the minimum required number of healthy inline tools.

When the total number of healthy inline tools in the inline tool group drops below the minimum required number of healthy inline tools, the failover action of the inline tool group determines the action to be taken.

Inline Tool Group Spare Inline Tool

One of the parameters of inline tool groups is a spare inline tool. If a spare is configured, the inline tool group becomes a redundant arrangement of inline tools. When the first failure occurs in a set of active inline tools, traffic will be forwarded to the spare with no loss, thus the spare will replace the failed tool in the active set.

The inline tools in the inline tool list are considered to be active inline tools. The traffic is hash-distributed over the active inline tools as long as all the inline tools are healthy. When one of the active inline tools fails, the spare inline tool takes the place of the failed inline tool and the new set operates as a new active set. If another inline tool fails, the traffic is redistributed according to the failover mode, as if there was no spare.

When the number of failed inline tools is such that the number of healthy inline tools is less than the `minimum-group-healthy-size`, the group heals itself by re-spreading the traffic over the healthy tools. When the number of healthy tools falls below the `minimum-group-healthy-size`, the failover action of the inline tool group takes place, while the failover action of the member inline tools is ignored.

The spare inline tool works with another parameter called `release-spare-if-possible`. When the inline tool that had been replaced with the spare inline tool recovers, the `release-spare-if-possible` parameter determines if the recovering inline tool is included in the active set of inline tools or if it becomes the new spare inline tool.

The default of the `release-spare-if-possible` parameter is disabled. Disabled means that even if the original inline tool recovers, the spare that replaced it will remain in the active set of inline tools. Enabled means that after the original inline tool recovers, the spare that replaced it will be released, if possible, from the active set of tools to become the spare again.

Configure the `minimum-group-healthy-size` and `release-spare-if-possible` parameters at the same time you configure the spare inline tool.

Symmetrical and Asymmetrical Hashing

One of the parameters of inline tool groups is hashing, which is used for distributing packets across a group of inline tools belonging to the inline tool group. The values for the hash parameter are as follows:

- **advanced**—Specifies symmetrical hashing, which is derived from the combination of packet fields based on the criteria selected for the advanced-hash algorithm configured under the **Ports > Port Groups > GigaStreams > Advanced Hash Settings** page.

For inline bypass applications, the most common choice of criteria for the advanced-hash algorithm is the combination of source IP and destination IP addresses. This produces a hash value that sends all traffic associated with the same session to the same inline tool in the inline tool group.

- **a-srcip-b-dstip**—Specifies asymmetrical hashing, which is derived from the source IP address for side A of the network and the destination IP address for side B of the network. This produces a hash value that sends all traffic associated with the same source address residing on side A to the same inline tool in the inline tool group, regardless of destination or session.
- **b-srcip-a-dstip**—Specifies asymmetrical hashing, which is derived from the destination IP address for side A of the network and the source IP address for side B of the network. This produces a hash value that sends all traffic associated with the same source address residing on side B to the same inline tool in the inline tool group, regardless of destination or session.

The default is **advanced**.

Use asymmetrical hashing if all traffic exchanged between a particular node on one side of the network and any nodes on the other side of the network that communicate with that node need to go to the same inline tool. The asymmetrical hashing options involve only source IP address (srcip) in one direction and only destination IP address (dstip) in the opposite direction. Bi-directional traffic, such as between a given user and all the Internet sites visited by the user, will be sent to the same inline tool in the group.

NOTE: When asymmetric hashing is configured, the portsrc and portdst packet fields are not included in the advanced-hash calculation for any GigaStream and inline tool groups across the GigaVUE node.

With symmetrical hashing, the inline network traffic path parameter can be configured to different values on the inline networks. With asymmetrical hashing, there is a restriction. Refer to [Asymmetrical Hashing Restrictions](#).

Refer to [Figure 303: Asymmetrical Hashing](#) for asymmetrical hashing.

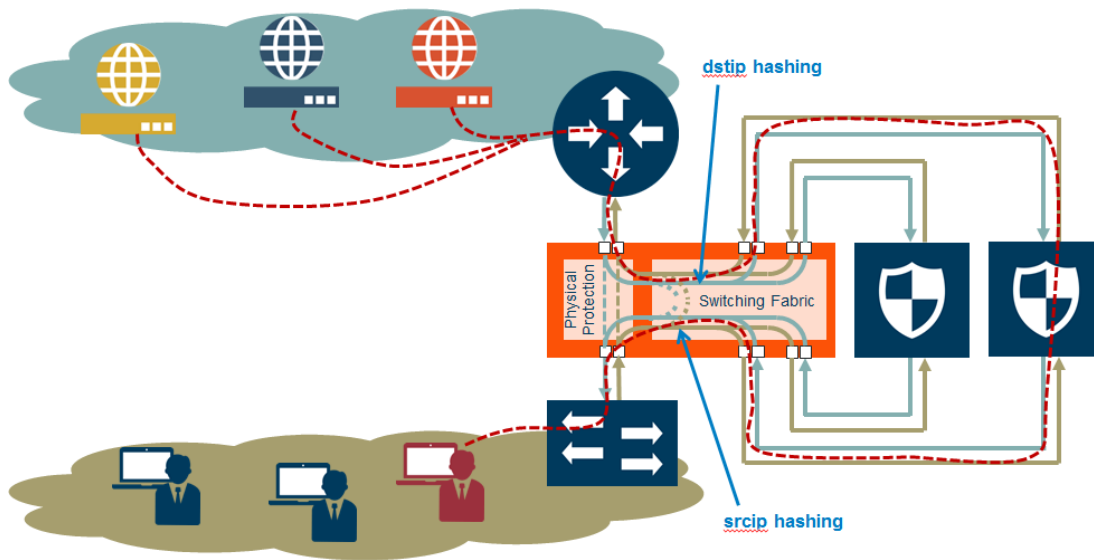


Figure 303: Asymmetrical Hashing

Use the hashing option **a-srcip-b-dstip** if the node is on side A of the network and the Internet is on side B. For example, Node A has IP address A. Traffic from Node A (from side A) will have IP address A. Traffic from side B (the Internet) destined for Node A, will have a destination of IP address A. This traffic will go to the same inline tool in the group.

If the network has the Internet on side A and the node on side B, use the hashing option **b-srcip-a-dstip**.

Asymmetrical Hashing Restrictions

The following are restrictions for asymmetrical hashing:

- If asymmetrical hashing is configured for the inline tool group, only rule-based maps or shared collector maps can be used to send traffic to the inline tool group. Inline map passalls cannot be used to send traffic to the inline tool group.
- For inline networks belonging to an inline network group, mapped to an inline tool group using asymmetrical hashing, the **Traffic Path** must be configured to the same value on all the inline networks, one of **Drop**, **Bypass**, **To Inline Tool**, or **ByPass with Monitoring**.

NOTE: For the inline networks belonging to an inline network group, mapped to an inline tool group using symmetrical hashing, the traffic path parameter can be configured to different values on the inline networks.

- If an inline network is involved in an inline map to an inline tool group configured with asymmetrical hashing, the inline network ports of the inline network cannot be used as the

Source in any out-of-band maps. Also, if the traffic path parameter for the inline network is configured to **ByPass with Monitoring**, there will not be any bypass traffic. All traffic will be forwarded to the inline tool group.

- When an inline tool group is included as a member of an inline series, asymmetrical hashing is not supported.

Resilient Weighted Hashing

One of the parameters of inline tool groups is weighting that provides you the ability to distribute traffic to the inline tools by assigning either an equal weighting or a custom weighting to the inline tools. You can assign custom weight in percentage or ratio. If an inline tool in a group goes down and the group maintains the **Minimum Healthy Group Size** that is defined for the group, the traffic is redistributed to the remaining tools based on the equal weighting or the custom weighting assigned to the tools. If the inline tool group does not meet the **Minimum Healthy Group Size** defined for the group, the traffic is redistributed based on the **Failover Action** defined for the group.

NOTE: Resilient hashing is not supported for classic inline maps.

The values for the weighting parameter are as follows:

- **Equal**—Traffic is distributed equally to all the inline tools in the inline tool group.
- **Relative**—Traffic is distributed to the inline tools in the inline tool group based on the relative weight or ratio assigned to the respective inline tools. The valid range is 1–256.
- **Percentage**—Traffic is distributed to the inline tools in the inline tool group based on the percentage assigned to the respective inline tools. The valid range is 1–100.

If you select **Relative** or **Percentage** as the weighting option, enter the hash weights for the inline tools that appear in the table below the **Weighting** drop-down list. Ensure that you assign a hash weight for each inline tool in the inline tool group.

About Inline Serial Tools

Use the **Inline Serial Tools Groups** configuration page to configure inline tools in a series, in which the traffic from one side of the inline network is guided through the members of the inline tool series before it is sent out the other side of the inline network. With inline tools and inline tools groups arranged in a series, the traffic from one inline tool or inline tool group flows to the next, so all tools see the same traffic.

The inline tool ports that make up the inline tools and inline tool groups participating in the inline tool series are always in pairs, running at the same speed, on the same medium (fiber or copper). All inline tool ports of the inline tool series must be on the same GigaVUE-HC3, GigaVUE-HC2, or GigaVUE-HC1 node. The inline tool ports and inline tool groups must also be on the same GigaVUE-HC3, GigaVUE-HC2, or GigaVUE-HC1 node as the inline network ports.

To view the currently configured inline tool series, select **Inline Bypass > Inline Serial Tools** to open the Inline Serial Tool Groups page shown in the following figure.

Refer to [Figure 304: Inline Serial Tools](#) for an illustration of an inline tool series. In [Figure 304: Inline Serial Tools](#), traffic is only shown from A-to-B.

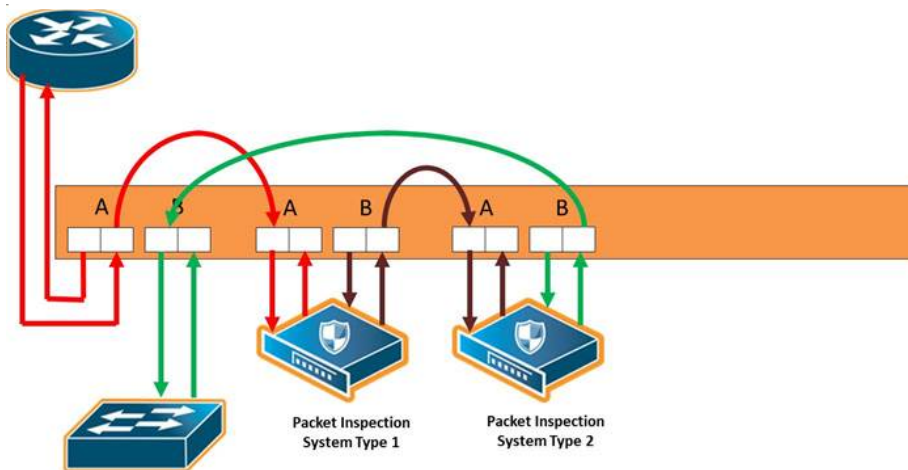


Figure 304: Inline Serial Tools

Refer to [Figure 305: Inline Tool Series, Including Inline Tool Group](#) for an inline tool series that includes an inline tool group in addition to individual inline tools. The per-direction-order is set to forwarding. In [Figure 305: Inline Tool Series, Including Inline Tool Group](#), the inline tool group is placed as the middle member of the series, but it could be placed as the first member of the series or the last member of the series as well. In the inline tool group, traffic is shared.

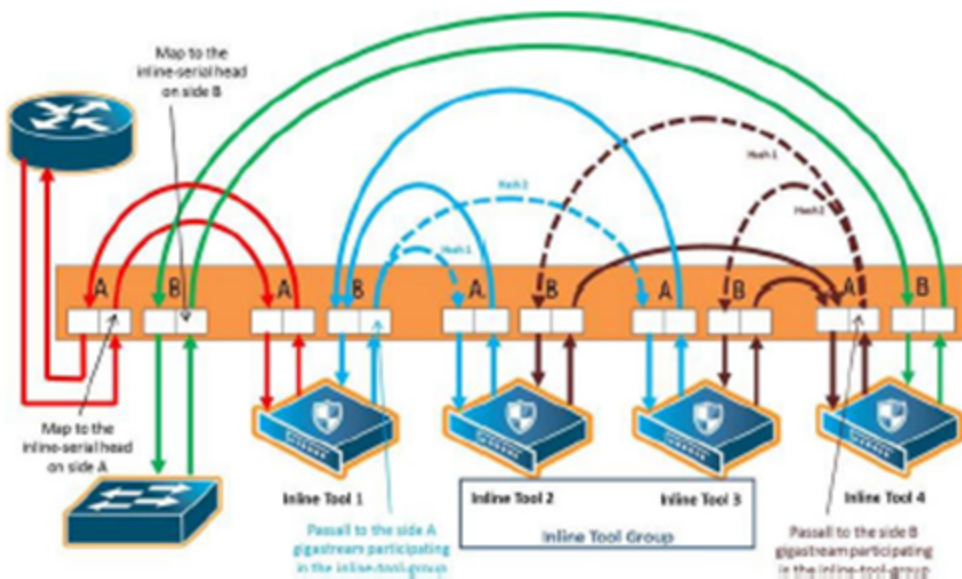


Figure 305: Inline Tool Series, Including Inline Tool Group

NOTE: For inline SSL decryption, the inline tool series does not support an inline tool group in the series.

The number of inline tools and inline tool groups in the inline series is limited only by the number of ports available for creating the inline networks and inline tools participating in the inline bypass solution.

When an inline tool group is included as a member of a inline series:

- a spare inline tool can be configured on the inline tool group
- inline maps to individual members of an inline tool group are not supported
- asymmetrical hashing is not supported, which means that the hash options, `ascrip-b-dstip` and `b-scrip-a-dstip`, are not allowed on the inline tool group.

To configure an inline serial tool group, do the following:

1. Open the **Inline Serial Tool Group** configuration page by selecting **Inline Bypass > Inline Serial Tools** from the main navigation pane, and then clicking **New**.
2. Enter a name for the inline serial tool group in the **Alias** field to identify the group and an optional description in the **Comment** field.
3. Select and order the inline tools for the inline tool group.
 - a. Click in the **Inline Tools** fields. The drop-down list shows the available inline tools
 - b. Select the inline tools or in or inline tool group to add to the inline serial tool group.

The inline tools are displayed in the order that they are selected. To change the order, click the up and down arrows.

4. Click **Save**.

NOTE: An inline serial tool group cannot be edited after it is saved.

Inline Serial Tools Global Failover Action

One of the parameters of inline tool series is the failover action taken in response to a failure of the inline tool series as a whole. This is referred to as the global failover action.

Each inline tool or inline tool group in the series can also have its own failover action. This is referred to as the local failover action. Refer to [Inline Tool Series Local Failover Action](#) for details.

For global failover actions, an inline tool series is declared to be in a failure condition as soon as any of its member inline tools goes into a failure condition. An inline tool series recovers from a failure condition after all the member inline tools recover from their failure conditions. The failover action attributes of the individual inline tools participating in an inline tool series are ignored. Instead, the **Failover action** configured on the Inline Serial Tool Group page for the inline tool series is executed. The values for global failover actions are as follows:

- **ToolBypass**—when the inline serial tools fails, the traffic that normally was directed to the inline tool is redirected to the bypass path. Use this failover action for configurations involving an inline serial tools that is associated with an inline network using rule-based maps. For configurations using map passalls, tool-bypass is the same as network-bypass. Refer to [Figure 306: Inline Tool Series Global Bypass Failover Action](#).
- **NetworkBypass**—when the inline serial tools fails, all traffic that would not have been dropped when the inline network or networks had a NORMAL forwarding state is directed to the bypass path. That is, all such traffic arriving at the side A inline network port or ports is forwarded to the side B inline network port or ports and all traffic arriving at the side B inline network port or ports is forwarded to the side A inline network port or ports. Refer to [Figure 306: Inline Tool Series Global Bypass Failover Action](#).
- **NetworkPortForcedDown**—when the inline serial tools fails, the inline network ports of the respective inline network are forced down. Refer to [Figure 307: Inline Tool Series Global Network Ports Forced Down Failover Action](#).
- **ToolDrop**—when the inline serial tools fails, the traffic that normally was directed to the inline tool is dropped. Use this failover action for configurations involving an inline serial tools that is associated with an inline network using rule-based maps. For configurations using map passalls, tool-drop is the same as network-drop. Refer to [Figure 308: Inline Tool Series Global Drop Failover Action](#).

- **NetworkDrop**—when the inline serial tools fails, all traffic coming to the respective inline network (or inline network group) is dropped. Refer to [Figure 308: Inline Tool Series Global Drop Failover Action](#).

The bypass path is between side A and side B of the inline network ports.

The default is **ToolBypass**.

Any failure of any member leads to the failure of the inline serial tools, hence the failover action for an inline serial tools will overwrite the failover action of the inline tool members of the series.

[Figure 306: Inline Tool Series Global Bypass Failover Action](#) to [Figure 308: Inline Tool Series Global Drop Failover Action](#) show the global failover actions for the inline series when any individual inline tool in the series fails.

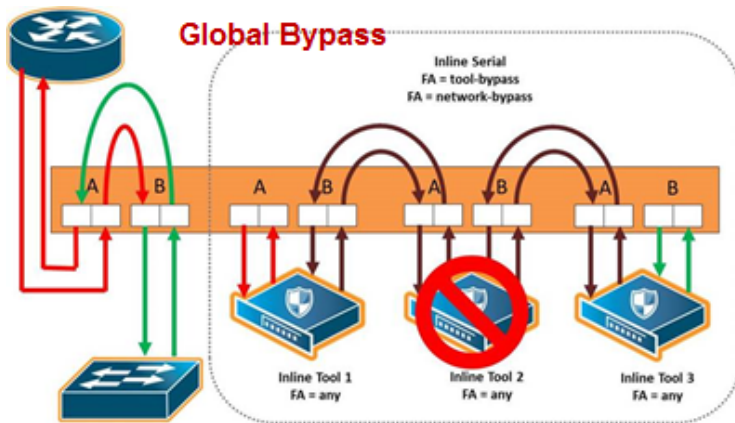


Figure 306: Inline Tool Series Global Bypass Failover Action

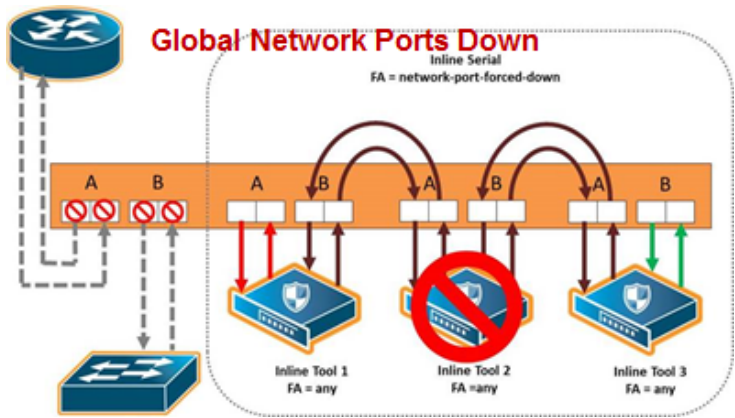


Figure 307: Inline Tool Series Global Network Ports Forced Down Failover Action

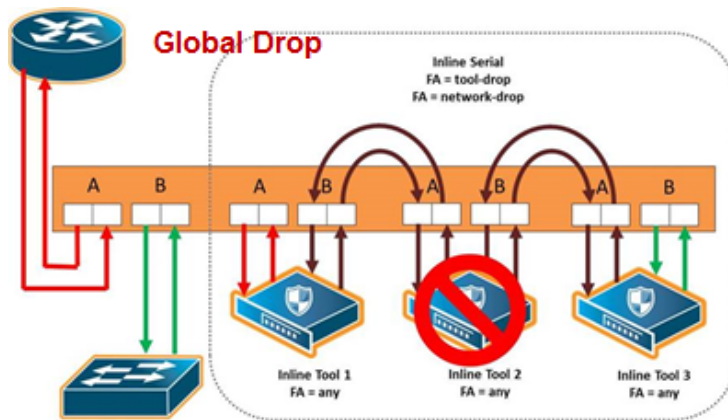


Figure 308: Inline Tool Series Global Drop Failover Action

Inline Tool Series Local Failover Action

Each inline tool in the series can have its own local failover action. When an individual inline tool or inline tool group in the series fails, the action taken depends on the failover action of the individual inline tool.

To configure local failover actions, configure a failover action of **Per Tool** for the series as a whole. Then the individual failover action for each inline tool in the series, as configured with the **inline Tool failover action**, takes effect. For details on the values, refer to [Inline Tool Failover Action](#).

For example, if the failover action of the inline series is configured as **Per Tool** and the failover action of an individual inline tool in the series is configured as **ToolBypass**, when that tool in the series fails, the traffic will skip over the failed tool.

NOTE: For inline SSL decryption, the **Per Tool** failover action is not supported.

The values for local failover actions are as follows:

- **ToolBypass**—when the inline tool fails, the traffic bypasses the failed tool. That is, the traffic originally coming to the inline tool is diverted to the next inline tool in the series or to the appropriate inline network port if the inline tool is the last in the series. Refer to [Figure 309: Inline Tool Series Local Tool Bypass Failover Action](#).

NOTE: When all the inline tools in a series are configured as **ToolBypass** and they all fail, this is the same as the failover action of **ToolBypass** for the series.

- **ToolDrop**—when the inline tool fails, traffic to this inline tool stops being forwarded. Effectively, this has the same result as the failover action of **ToolDrop** for the series as a whole, although the healthy members of the series will still receive traffic in one of the directions. Refer to [Figure 310: Inline Tool Series Local Tool Drop Failover Action](#).

- **NetworkBypass**—when the inline tool fails, a bypass is established between the inline network ports. Refer to [Figure 311: Inline Tool Series Local Network Bypass Failover Action](#).
- **NetworkDrop**—when the inline tool fails, traffic is dropped at the inline network ports. Refer to [Figure 312: Inline Tool Series Local Network Drop Failover Action](#).
- **NetworkPortForcedDown**—when the inline tool fails, the links for the inline network ports are brought down. Refer to [Figure 313: Inline Tool Series Local Network Ports Forced Down Failover Action](#).

Figure 309: Inline Tool Series Local Tool Bypass Failover Action to Figure 313: Inline Tool Series Local Network Ports Forced Down Failover Action show the local failover actions when an individual inline tool in a series fails

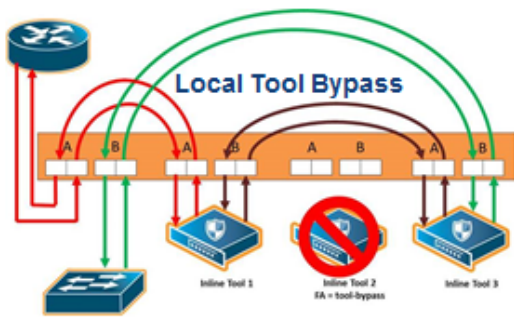


Figure 309: Inline Tool Series Local Tool Bypass Failover Action

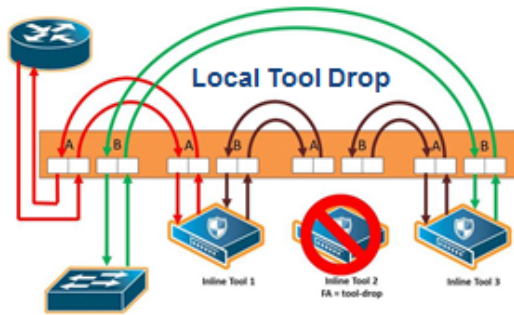


Figure 310: Inline Tool Series Local Tool Drop Failover Action

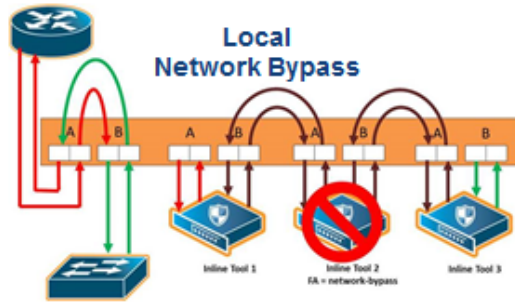


Figure 311: Inline Tool Series Local Network Bypass Failover Action

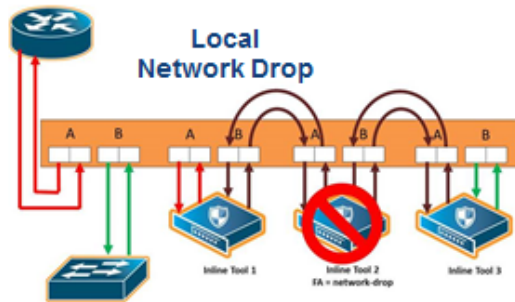


Figure 312: Inline Tool Series Local Network Drop Failover Action

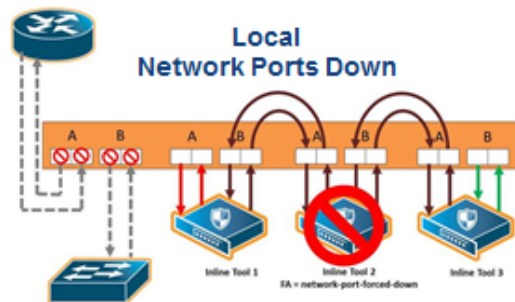


Figure 313: Inline Tool Series Local Network Ports Forced Down Failover Action

Figure 314: Inline Tool Series Local Failover of Two Tools shows the failure of two individual inline tools in a series with different configured failover actions.

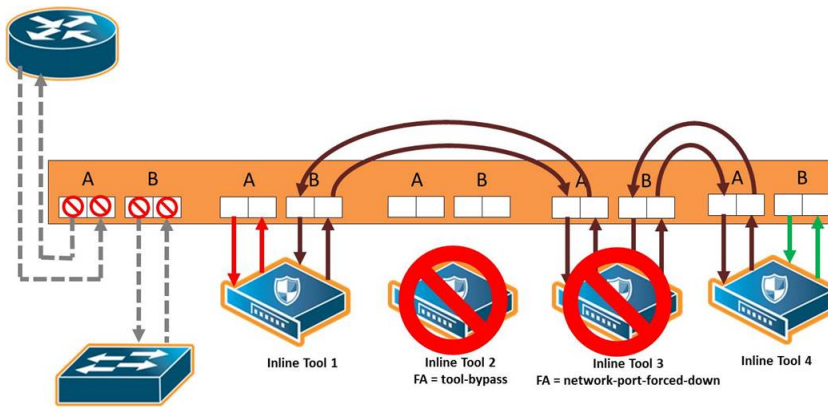


Figure 314: Inline Tool Series Local Failover of Two Tools

Inline Tool Series Per-Direction Order

One of the parameters of inline tool series is the per-direction order of the inline tool series. This parameter configures the traffic direction order of side B traffic with respect to the inline tool list, that is, the direction of the return traffic.

The **Return Direction** options on the Inline Serial Tool Group page specify the per-direction order of the side B traffic of the inline tool series as follows:

- **Reverse** specifies that the traffic from network B will flow through the inline tool list in reverse order, for example, from the third tool, to the second tool, to the first tool. This specifies the reverse order of inline tools for both directions.
- **Forward** specifies that the traffic from network B will flow through the inline tool list in the order it which it is defined, for example, from the first tool, to the second tool, to the third tool. This specifies the same order of inline tools for both directions of traffic.

The default is **Reverse**.

Figure 315: Inline Tool Series Per-Direction Order: Simplified Reverse and Forward shows a simplified view of the flow through the tools:

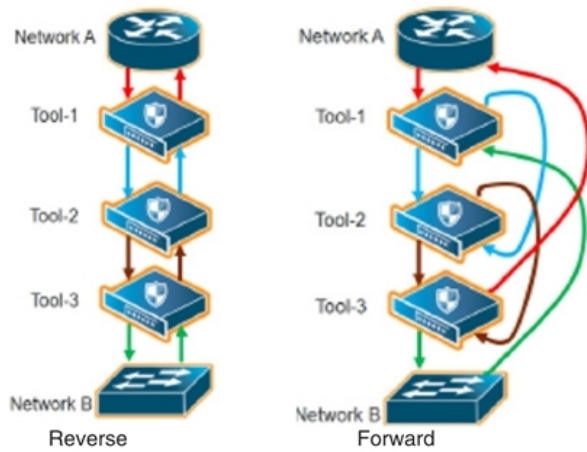


Figure 315: Inline Tool Series Per-Direction Order: Simplified Reverse and Forward

In Figure 315: Inline Tool Series Per-Direction Order: Simplified Reverse and Forward, **Reverse** is on the left and **Forward** is on the right. Traffic from network side A to network side B for both reverse and forward flows from the first tool, to the second tool, to the third tool. But traffic from network side B to network side A with reverse, flows from the third tool, to the second tool, to the first tool, whereas traffic from network side B to network side A with forward, flows from the first tool, to the second tool, to the third tool.

Figure 316: Inline Tool Series Per-Direction: Reversed shows the reverse direction with the tools connected to the GigaVUE node.

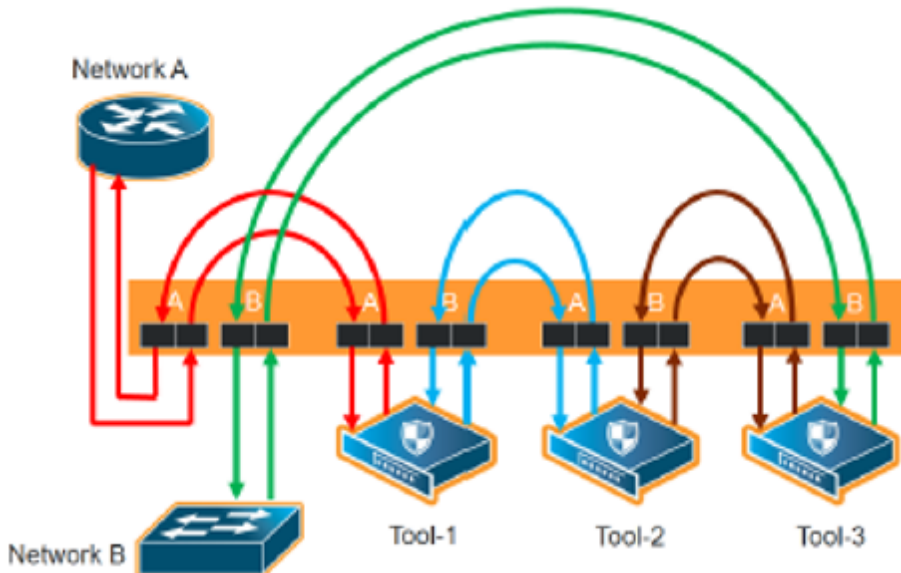


Figure 316: Inline Tool Series Per-Direction: Reversed

Figure 316: Inline Tool Series Per-Direction: Reversed shows the forward direction with the tools connected to the GigaVUE node.

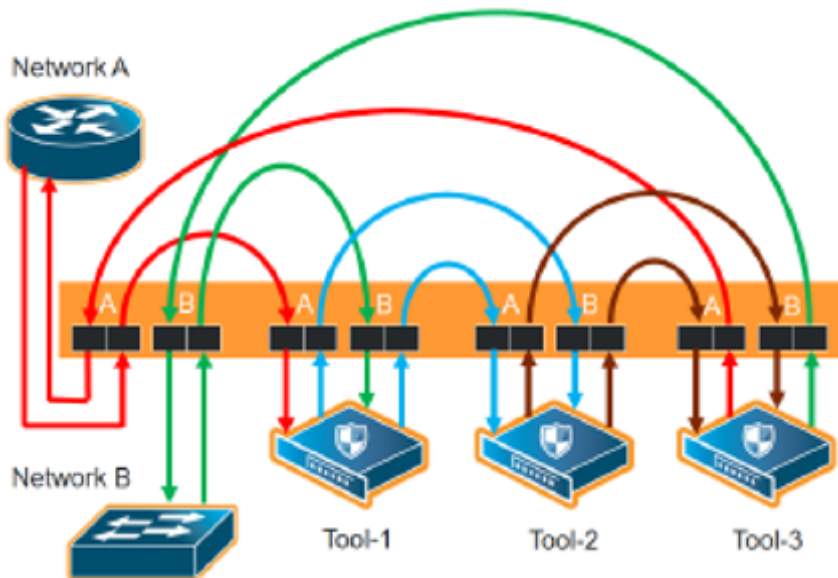


Figure 317: Inline Tool Series Per-Direction: Forward

Since the per-direction default value in software version 4.7 is different than the default value in older software versions, refer to [Recommendation When Upgrading from Older Software Versions](#).

Recommendation When Upgrading from Older Software Versions

In software versions prior to 4.4, the only direction was **Forward**, so it was the default. Starting in software version 4.7, there are options for both **Forward** and **Reverse**, with **Reverse** as the default.

When upgrading from an older software version such as 4.3, the recommendation is to remove the existing inline serial configuration before the upgrade, then reconfigure the inline series after the upgrade to 4.7.

Associate Inline Networks with Inline Tools Using Inline Maps

Inline networks and inline network groups are associated with inline tools, inline tool groups, and inline serial tools through inline maps. An inline map is a regular map, but the **Source** and **Destination** fields specify inline software constructs instead of port lists.

On the **Edit Map** or **New Map** page, the **Source** field specifies the inline network alias or inline network group alias. The **Destination** field specifies an inline tool alias, an inline tool group alias, an inline tool series alias, or an inline bypass. An inline bypass is a special construct that is used as a pseudo-inline tool to allow a portion of traffic to bypass any inline tools.

Maps can associate a network with multiple inline tools or they can associate multiple inline networks with the same inline tool or with multiple inline tools.

With inline maps, only the traffic that meets the map rules is sent to the tools, to bypass, or to shared collectors. For example, you can send traffic to tools for which they are specialized and send the rest to bypass. Or, if there is a type of traffic in which the tools are not interested or do not understand, that traffic can be sent to a shared collector.

NOTES:

- When an inline network is mapped to an inline tool or inline tool group, a second inline network cannot be mapped to the same inline tool. (In other words, an inline tool can be used in only one map.) However, when there are multiple inline networks, use an inline network group to map to the same inline tool.
- If an inline tool is already specified in a map, that tool cannot be included in an inline tool group (unless the map is first deleted).
- Inline network ports, inline tool ports, and out-of-band tool ports that are used in map configuration must all be configured on the same GigaVUE-HC3, GigaVUE-HC2, or GigaVUE-HC1 node. Even if nodes are in a cluster, the inline ports cannot be on different nodes.

Refer to the following sections:

- [Inline Map Passall](#)
- [Inline Map](#)
- [Inline Map Shared Collector](#)
- [Inline Maps to Individual Members of an Inline Tool Group](#)
- [Out-of-Band \(OOB\) Map](#)
- [Symmetric and Asymmetric Maps](#)

Inline Map Passall

Use the **Pass All** subtype to configure a type of inline map that passes all traffic. Map-passalls facilitate the sending of traffic between inline network ports (through inline tools or bypass). All of the inline network ports and inline tool ports involved in an inline map must be located on the same Gigamon node.

Use the **Source** of the **Pass All** to specify a single inline network.

Use the **Destination** of the **Pass All** to specify an inline tool alias, an inline tool group alias, an inline tool series alias, or an inline bypass. An inline bypass is a special construct that is used as a pseudo inline tool to allow a portion of traffic to bypass any inline tools.

An inline bypass, using the physical bypass option, is only valid if the **Source** is an inline network port. This applies only to the **Pass All** subtype for asymmetrical scenarios.

Inline Map

Use the **New Map** page to configure a type of inline map that uses rules to direct traffic. These inline maps are referred to as rule-based maps. All of the inline network ports and inline tool ports involved in an inline map must be located on the same GigaVUE node.

Use the **Source** field to specify an inline network alias or an inline network group alias.

Support for rule-based maps is limited to symmetric scenarios, which means that the **Destination** of rule-based inline maps can only be aliases of inline networks or inline network groups (not individual ports).

Use the **Destination** to specify an inline tool alias, an inline tool group alias, an inline tool series alias, or an inline bypass. An inline bypass is a special construct that is used as a pseudo inline tool to allow a portion of traffic to bypass any inline tools.

For rule-based maps, the **Destination** can be configured to inline bypass with no restrictions, so long as the **Source** specifies either an inline network or an inline tool.

Use the **Priority** to order inline maps by priority. For example, you can specify the highest priority map to be for encrypted traffic and lowest priority map to be for a shared collector. You can also place inline maps before or after one another using the **Priority**.

Use the **Type** to specify any map rule.

Inline Map Shared Collector

Use the **Collector** subtype to configure a shared collector to which to send any packets that do not match the map rules in the inline maps. Use a shared collector with one or more rule-based inline maps. All of the inline network ports and inline tool ports involved in an inline shared collector map must be located on the same GigaVUE node.

Use the **Source** argument to specify an inline network alias or an inline network group alias.

Use the **Destination** argument to specify an inline tool alias, an inline tool group alias, an inline tool series alias, or an inline bypass. An inline bypass is a special construct that is used as a pseudo inline tool to allow a portion of traffic to bypass any inline tools.

For shared collector maps, the **Source** field can be configured to inline bypass with no restrictions, so long as the **Destination** field specifies either an inline network or an inline tool.

Support for shared collector inline maps is limited to symmetric scenarios, which means that the **Destination** field of rule-based inline maps can only be aliases of inline networks or inline network groups (not individual ports).

Inline Maps to Individual Members of an Inline Tool Group

Prior to software version 4.4, the **Map** page was used to configure an inline map that directed traffic to the inline tool group as a whole. The map could be rule-based or passall. There was only one type of hashing available, which distributed the traffic across the tools in the inline tool group.

Starting in software version 4.4, the **Map** page can also be used to configure inline maps to the individual members of an inline tool group. The maps must be rule-based. There are also more hashing options that can be specified for traffic that does not match any of the map rules. The hashing options are described in [Symmetrical and Asymmetrical Hashing](#).

The rule-based maps are defined with the inline tool group sharing the same source, either an inline network or an inline network group in the **Source** field of the map. The map destinations (the **Destination** field of the map) are the individual inline tools in the group. Traffic not matching any of the map rules is sent to a shared collector to be distributed according to the specified hashing value.

The shared collector must also have the same source as the maps to the individual members of the inline tool group. The destination for the shared collector is the inline tool group. The shared collector map is a mandatory part of the configuration.

Both configurations are available: either a single map to the inline tool group as a whole, or multiple rule-based maps to the individual members of the inline tool group plus a shared collector; however, they cannot both be configured at the same time.

Refer to [Figure 318: Rule-Based Maps to Individual Tools in an Inline Tool Group](#) for the rule-based maps to the individual members of the inline tool group. In [Figure 318: Rule-Based Maps to Individual Tools in an Inline Tool Group](#), traffic is only shown from A-to-B.

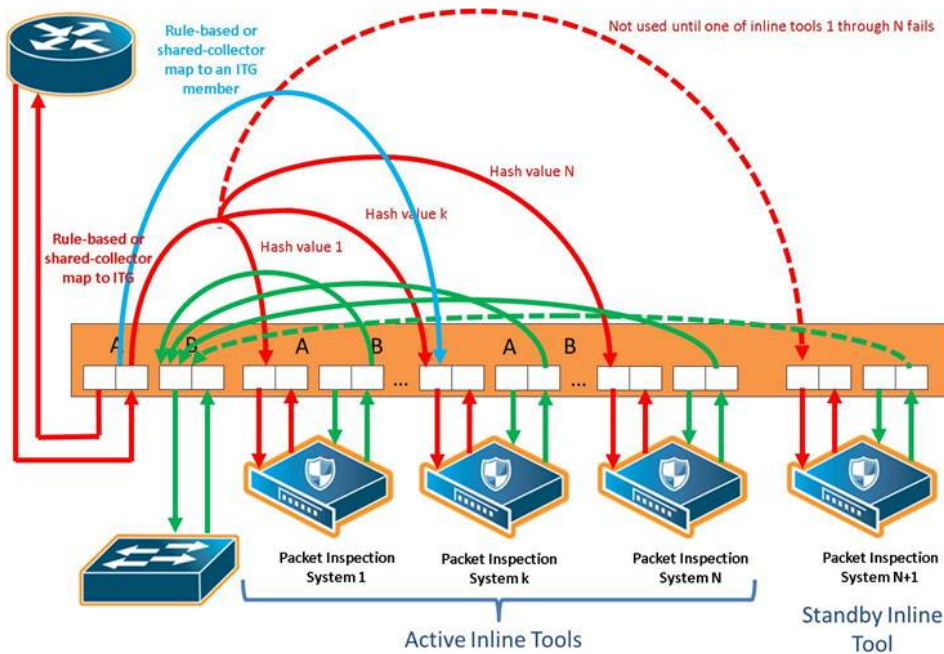


Figure 318: Rule-Based Maps to Individual Tools in an Inline Tool Group

Map, Inline Tool, and Inline Tool Group Configuration Restrictions

The following are map, inline tool, and inline tool group configuration restrictions for the rule-based maps to the individual members of the inline tool group:

- If there is a map to the inline tool group as a whole, there cannot also be rule-based maps to the individual inline tools in the group.
- Maps to the individual inline tools in a group must be rule-based. Map passalls to the individual tools cannot be configured.
- The source of rule-based maps to the individual inline tools in a group must be the same (either the same inline network or the same inline network group). The shared collector must have the same source as well.
- If there is a map configured to the individual inline tools in a group, the inline networks must have their traffic path set to **to-inline-tool**. This applies to individual inline networks as well as to inline networks involved in an inline network group.
- For the individual inline tools in a group, the recovery mode of the individual inline tools must be configured as **automatic**. A recovery mode of **manual** cannot be configured.
- For the inline tool group, the failover action must be either **NetworkBpass** or **NetworkDrop**. A failover action of either **ToolBypass** or **ToolDrop** for the inline tool group cannot be configured.
- Only one inline shared collector map can be configured (among the set of inline maps).

- Maps must be created in a specific order. The shared collector map must be configured last. For example, if there are three inline tools in the group, configure the three maps to the individual members of the group first, then configure the shared collector map.
- Maps must be deleted in a specific order. The shared collector map must be deleted first. Then the maps to the individual members of the group can be deleted.
- Once the shared collector map is configured, any changes to the maps to the individual members of the group are restricted. Only the map rules can be edited.

NOTE: All the rules in a map cannot be deleted. All maps must have attributes for **Source, Destination**, and at least one **rule** configured.

- When an inline tool group is included as a member of an inline series, inline maps to individual members of an inline tool group are not supported.
- If one of the inline tools is disabled in an inline-network-group to inline-tool-group map that has the same ingress VLAN tag on the ports of an inline-network pair then the traffic will be looped back to the same network. This behavior is seen only with passall maps. In above scenarios use rule-based maps instead of passall maps.

Inline Tool Failures and Failover Actions

An inline tool group has a failover action for the group as a whole. The failover action is taken in response to a failure when the number of healthy inline tools in the inline tool group (including the spare inline tool, if configured) falls below the configured minimum. In addition, the individual inline tools in the group have failover actions.

When there are maps to individual inline tool members of the group, an inline tool has both a group failover action and an individual failover action.

Refer to [Failover Actions When an Individual Tool in an Inline Tool Group Fails](#) for the failover actions when an individual inline tool in an inline tool group fails.

Table 57: Failover Actions When an Individual Tool in an Inline Tool Group Fails

Inline Tool Group Spare	Number of Healthy Tools	When Individual Inline Tool Fails:	
		Traffic to Inline Tool Group	Traffic to Failed Tool
no spare	equal to or greater than the configured minimum healthy size	is redistributed among the remaining healthy tools in the group	no action—the failover action of the individual inline tool is ignored. If there is an inline map to the failed inline tool, the connectivity arrangements supporting

Inline Tool Group Spare	Number of Healthy Tools	When Individual Inline Tool Fails:	
		Traffic to Inline Tool Group	Traffic to Failed Tool
			the individual map are maintained as if nothing happened.
	less than the configured minimum healthy size	fails over according to the failover action for the inline tool group	no action—the failover action of the individual inline tool is ignored. If there is an inline map to the failed inline tool, the connectivity arrangements supporting the individual map are maintained as if nothing happened.
spare	equal to or greater than the configured minimum healthy size	is redistributed among the remaining healthy tools	no action—the failover action of the individual inline tool is ignored. If there is an inline map to the failed inline tool, the connectivity arrangements supporting the individual map are maintained as if nothing happened.
	less than the configured minimum healthy size	fails over according to the failover action for the inline tool group	no action—the failover action of the individual inline tool is ignored. If there is an inline map to the failed inline tool, the connectivity arrangements supporting the individual map are maintained as if nothing happened.
failed spare	N/A	no action, if there is no inline map configured to the spare	no action—the failover action of the individual inline tool (in this case, the spare) is ignored. If there is an inline map to the failed inline tool, the connectivity arrangements supporting the individual map are maintained as if nothing happened.

Maps That May Lead to Selective Traffic Drops

With inline bypass solutions based on inline flow mapping, the use of rule-based maps can lead to selective traffic drops. Traffic drops can occur as follows:

- if a shared collector from the inline network or inline network group has not been configured. Packets not matching the criteria specified by the rules in the configured rule-based maps will be dropped.
- if drop rules have been included in the rule-based maps configured from the inline network or inline network group

In most inline flow mapping solutions, all traffic exchanged between the two end nodes of a given inline network are expected to be processed by the inline tool or tools associated with this inline network through the configured maps. Therefore, it is recommended to always configure a shared collector and to not include drop rules in the rule-based maps.

Out-of-Band (OOB) Map

All inline network ports and inline tool ports can be subject to monitoring by listen-only tools. This means that an inline network port or inline tool port can be listed in the **Source** field in which the **Destination** field is an arbitrary tool type of port located anywhere in the system and not limited to the same node.

Inline network ports and inline tool ports involved in rule-based inline maps can be used as network ports for monitoring (or out-of-band) maps.

Out-of-band (OOB) maps are supported as follows:

- If the inline bypass solution use passalls, the OOB arrangements can use any rule-based maps or map shared collectors, or passalls. Refer to [Figure 319: Out-of-Band Rule-Based Maps](#).
- If the inline bypass solution use rule-based maps or map shared collectors, the OOB arrangements can use only map passalls. Refer to [Figure 320: Out-of-Band Map Passalls](#).
- When the source port of an OOB map is associated with an inline network, a list of inline ports is supported in the port list (the **Source** field of the Map page).

The following restrictions apply to OOB maps:

- When the source port of an OOB map is associated with an inline network group, only a single inline port (network or tool) is supported in the port list. In this case, multiple OOB maps are needed because each OOB map only accepts one inline port (network or tool) in the **Source** field on the Map page.
- OOB maps from inline network ports of inline networks involved in maps to inline tool groups configured with asymmetrical hashing are not allowed. If an inline network is involved in an inline map to an inline tool group configured with asymmetrical hashing, the inline network ports of the inline network cannot be used as the **Source** attribute in any out-of-band maps.

Prior to software version 4.4, if an inline network was part of an inline network group, sending traffic to an out-of-band tool was not allowed.

Starting in software version 4.4, out-of-band maps from inline ports involved in inline network groups are supported. You can configure OOB maps originating from inline network ports or inline tool ports when these ports are involved in an inline network group, except for the following:

- GigaSMART operations
- tool ports located on a different node

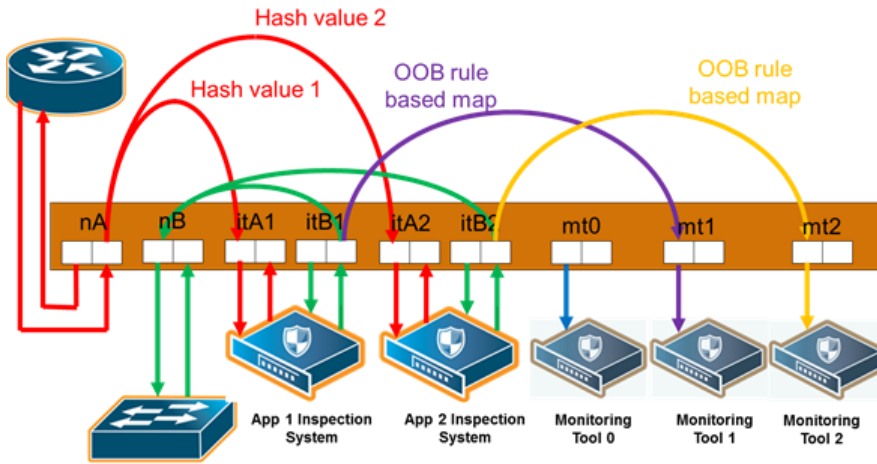


Figure 319: Out-of-Band Rule-Based Maps

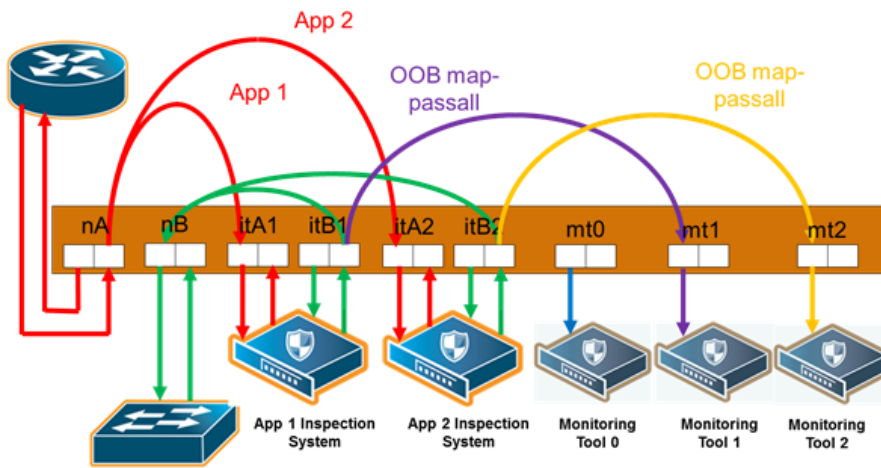


Figure 320: Out-of-Band Map Passalls

Symmetric and Asymmetric Maps

In a symmetric map configuration, the southbound and northbound forwarding to the tools is the same. For example, traffic from A to B goes through an inline tool, as does traffic from B to A. Rule-based maps are limited to symmetric configurations.

In an asymmetric map configuration, the southbound traffic is distributed to the inline tools, but northbound traffic can be sent through uninspected. For example, traffic from A to B goes through an inline tool, but traffic from B to A bypasses it.

Asymmetric configurations are only supported with map passalls. Traffic can come from individual inline networks, be sent to individual inline tools or inline tool groups, or to bypass.

Symmetrical combinations of two asymmetrical arrangements (that is, with both side A and side B pointing to the inline tool or to bypass) are not allowed.

Some IPSs do not need to inspect northbound traffic. For example, those focused on preventing Denial of Service (DoS) attacks, may not need to keep track of session flows and may only be concerned about southbound traffic.

Conversely, data loss prevention systems, those that are more concerned about what sensitive data is leaving the protected network than what is coming in, may focus solely on northbound traffic.

Configuration Steps

The configuration steps in summary for an inline bypass solution are as follows:

1. Configure inline network ports. (Optional for protected inline network.)
2. Configure inline network. (Optional for protected inline network.)
3. (Optional) Configure inline network group.
4. (Optional) Configure heartbeat or negative heartbeat profile.
5. Configure inline tool ports.
6. Configure inline tool.
7. (Optional) Configure inline tool group.
8. (Optional) Configure inline tool series.
9. Configure inline maps, either passall, map (rule-based), map shared collector, or bypass.
10. Configure non-default values for parameters of the inline networks or inline tools.

The summary steps are shown in [Figure 321: Configuration Steps for Inline Bypass Solutions](#).

Figure 321: Configuration Steps for Inline Bypass Solutions

The configuration details for an inline bypass solution are as follows:

1. Configure inline network ports. (Optional for protected inline network.)

The configuration begins with defining the inline network ports that will participate in the inline network. Use Quick Port Editor to configure a port type of inline-network.

For an unprotected inline network, you configure the inline network ports.

For a protected inline network, the ports are created automatically when the bypass combo modules are recognized by the GigaVUE HC Series node.

For detailed steps, refer to [Configure Inline Network Ports](#).

2. Configure inline network. (Optional for protected inline network.)

Next configure the inline network or inline networks using the **inline Network** configuration page and the port pairs defined in step 1.

For an unprotected inline network, you configure the inline network.

For a protected inline network, the inline network is created automatically when the bypass combo modules are recognized by the GigaVUE HC Series node.

In either case, the inline network will have parameters set to default values, such as, the **Traffic Path** will be set to **Bypass** and the **Physical Bypass** will enable.

The initial forwarding state of the unprotected inline network will be DISABLED. The initial forwarding state of the protected inline network will be PHYSICAL BYPASS.

For detailed steps, refer to [Configure Inline Network \(Unprotected\)](#).

3. (Optional) Configure inline network group.

If the inline bypass solution involves an inline network group, first configure the participating inline networks before configuring the inline network group. Use the **Inline Network Group** configuration page to configure the inline network group and see the list of inline networks defined in step 2 by selecting **Inline Bypass > Inline Network Groups**.

For detailed steps, refer to [Configure Inline Network Group](#)

4. (Optional) Configure heartbeat or negative heartbeat profile.

If any of the inline tools will be using a heartbeat profile, a default heartbeat profile is provided, so no configuration is needed except a name. However, if any of the inline tools will be using a heartbeat profile with non-default settings, first configure the heartbeat profile using the **Heartbeats** configuration page, before configuring the inline tools that will use that profile.

If any of the inline tools will be using a negative heartbeat profile, configure the negative heartbeat profile by providing an alias and a PCAP file using the **Heartbeats** configuration page, before configuring the inline tools that will use that profile

For detailed steps, refer to [Create Heartbeat Profile](#) and [Create Negative Heartbeat Profile](#).

5. Configure inline tool ports.

Next configure inline tool ports. Use Quick Port Editor to configure the ports a port type of **Inline Tool**

For detailed steps, refer to [Configure Inline Tool Ports](#).

6. Configure inline tool.

Next configure the inline tool or inline tools using the **inline Tool** configuration page and the port pairs defined in step 5.

For detailed steps, refer to [Configure Inline Tool](#).

7. (Optional) Configure inline tool group.

If the inline bypass solution involves an inline tool group, first configure the participating inline tools, before configuring the inline tool group. Use the **inline Tool Group** configuration page to configure the inline tool groups and see the list the inline tools defined in step 6 by selecting **Inline Bypass > Inline Tool Groups**.

For detailed steps, refer to [Create Inline Tool Group](#).

8. (Optional) Configure inline tool series.

If the inline bypass solution involves an inline tool series, first configure the participating inline tools, before configuring the inline tool series. Use the **inline Serial Tools Group** configuration page and list the inline tools defined in step 6 by selecting **Inline Bypass > Inline Serial Tools**.

9. Configure inline maps, either map passall, map (rule-based), or map shared collector.

The next configuration step is to configure inline maps that specify how to direct the traffic from the configured inline networks and inline network groups to the configured inline tools, inline tool groups, and inline tool series. You can configure either a map passall, a map (rule-based), or a map shared collector. Create a map with type **Inline** and a subtype of **ByRule**, **Pass All**, or **Collector**.

For details about configuring maps, refer to [Manage Maps](#).

10. Configure non-default values for parameters of the inline networks or inline tools.

Now configure non-default values for inline network parameters. For example, for an unprotected inline network, when you change the **Traffic Path** to **To Inline Tool**, traffic will start flowing through the inline tools from the unprotected inline network. For a protected inline network, when you uncheck **Physical Bypass**, traffic will start flowing through the inline tools from the protected inline network.

For protected inline networks, to start the traffic flowing, perform the following steps under Configuration on the Inline Network configuration page:

1. Change the **Traffic Path** to **To Inline Tool**.
2. Uncheck the **Physical Bypass**.

Configuration Step Details

This section provides detailed steps for configuring inline bypass through the GigaVUE-OS H-VUE UI.

Configure Inline Network Ports

Use the following procedure to create inline network ports:

1. Select **Ports > All Ports**.
2. Open Quick Port Editor by clicking the **Port Editor** button.

3. Use the Quick search field to Find the ports to configure.
4. In the Alias field enter a name to help identify the inline port.
5. For Type, select **Inline Network**.

An Inline Network (unprotected) is a software arrangement of two network-type ports allocated to facilitate access to a bidirectional link between two networks (far end network devices) that are linked to inline tool ports.

6. Click **OK**.

NOTE: Any available network-type ports on a Gigamon node can be used to form an unprotected inline network.

Configure Inline Network (Unprotected)

An Inline Network Group is an arrangement of multiple inline network ports to which traffic is distributed based on calculated hash values used by a Gigamon node.

Perform the steps to configure an inline network:

1. After configuring the Inline Network ports, select **Inline Bypass > Inline Networks**.
2. Click **New**.
3. In the **Alias** field, enter an alias for the inline network to help identify the inline network.
4. From the **Port A** drop-down list select an inline network port.
5. An inline network port is automatically selected for **Port B**. To select a different port, select one from the **Port B** drop-down list if there is more than one inline network port.
6. Select a traffic path from the **Traffic Path** drop-down list. The types of traffic paths are:
 - **Bypass** — All traffic arriving at the Port A inline network port is directly forwarded to the Port B inline network port and all traffic arriving at the Port B inline network port is directly forwarded to the Port A inline network port.
 - **Drop** — No traffic is exchanged through the inline network ports (all traffic coming to these ports is dropped).
 - **ByPass with Monitoring** — All traffic is forwarded as a forced bypass value and a copy of the traffic is also forwarded to the inline tools. A traffic map must first be configured between the inline network and the inline tool to have the traffic forwarded with no traffic taken from the inline tools.
 - **To Inline Tool** — The traffic received at the inline network ports is forwarded based on:

1. The traffic map between the inline network and the respective inline tools.

2. The failover action attributes of the inline tools

3. The health state of the inline tools.
7. Select the **Link Propagation** check box to enable whether the inline network link on one side of the inline network gets propagated to the other side.
8. Click **Save**.

Configure Inline Network Group

An Inline Network Group is an arrangement of multiple inline network ports to which traffic is distributed based on calculated hash values used by Gigamon node.

Perform the following steps to configure an Inline Network Group:

1. After configuring the Inline Network Ports, select **Inline Bypass > Inline Network Groups**.
2. Click **New**.
3. In the **Alias** field, enter a name for the network group.
4. From the **Inline Network** drop-down list, select the Inline Network ports.
5. Click **Save**.

Create Heartbeat Profile

The Heartbeat Profile is a data structure that contains the heartbeat attributes that are applied to an Inline Tool for configuring its heartbeat. The Create Heartbeat Profile wizard allows you to apply attribute values for the heartbeat profile. Use the following procedure:

1. Select **Inline Bypass > Heartbeats**.
2. Click **New**.
3. In the **Alias** field, enter a name for your heartbeat profile.
4. In the **Type** field, select **Regular**.

For details about regular heartbeats, refer to [Standard Heartbeat](#).

5. Use **Packet Format** drop-down list to select a packet type. The formats are:
 - **ARP**—This protocol (Address Resolution Protocol) is used for resolution of network layer address into link layer addresses, which is critical for multiple-access network operation. ARP is the default.
 - **Custom**—This format is a binary packet content associated with a packet capture (pcap) file. For details about custom packet format, refer to [Standard or Custom Heartbeat Packet](#).

When you select **Custom**, a **Custom Format** field displays with a **Browse** button. Use the **Browse** button to upload the pcap file.

6. Use the **Direction** drop-down menu to select the direction for sending heartbeat. The directions are:
 - **A to B**—From Port A to Port B of the inline tool.
 - **B to A**—From Port B to Port A of the inline tool.
 - **Bi-directional**—Both directions.
7. In the **Timeout** field, enter a number in milliseconds to indicate a timeout period for heartbeat packets between sending and receiving. The acceptable range is 20 to 1000 milliseconds. The default is 500 milliseconds.
8. In the **Period** field, enter a number in milliseconds for sending subsequent heartbeat packets. The acceptable range is 30 to 5000 milliseconds. The default is 1000 milliseconds.
9. In the **Recovery Time** field, enter a number in seconds to indicate that the inline tool is declared up with successfully receiving packets. The acceptable range is 5 to 60 seconds. The default is 30 seconds.
10. In the **Retries** field, enter the number for consecutive timed-out heartbeat packets at which the system will trigger (retry) a fail over condition.
11. Click **Save**.

The heartbeat profile appears in the Heartbeat Profile table.

NOTE: Highlight the heartbeat profile and click **Edit** to modify the parameters, if needed.

Create Negative Heartbeat Profile

The Negative Heartbeat Profile is a data structure that contains the negative heartbeat attributes that are applied to an Inline Tool for configuring its negative heartbeat. The Create Heartbeat Profile wizard allows you to apply attribute values for the negative heartbeat profile. Use the following procedure:

1. Select **Inline Bypass > Heartbeats**.
2. Click **New**.
3. In the **Alias** field, enter a name for your heartbeat profile.
4. In the **Type** field, select **Negative**

This is a negative heartbeat profile. For details about negative heartbeats, refer to [Negative Heartbeat Profiles](#).

5. Use **Browse** button in the **Custom Format** field to upload binary packet content associated with a packet capture (pcap) file. For details about the custom format, refer to [Standard or Custom Heartbeat Packet](#).

6. Use the **Direction** drop-down menu to select the direction for sending heartbeat. The directions are:
 - **A to B**—From Port A to Port B of the inline tool.
 - **B to A**—From Port B to Port A of the inline tool.
 - **Bi-directional**—Both directions.
7. In the **Period** field, enter a number in milliseconds for sending subsequent negative heartbeat packets. The acceptable range is 30 to 5000 milliseconds. The default is 1000 milliseconds.
8. In the **Recovery Time** field, enter the minimum number of seconds since the last negative heartbeat packet is received to declare that the inline tool is up.

The inline tool is up from the standpoint of the negative heartbeat if the negative heartbeats sent are *not* received. When a tool is declared down, sent heartbeats should not be received for a number of seconds in order to declare the tool as being up.

The acceptable range for the Recovery Time field is 5 to 60 seconds. The default is 30 seconds.

9. Click **Save**.

The heartbeat profile appears in the Heartbeat Profile table.

NOTE: Highlight the heartbeat profile and click **Edit** to modify the parameters, if needed.

Configure Inline Tool Ports

Use the following procedure to create inline tool ports:

1. Select **Ports > All Ports**.
2. Open Quick Port Editor by clicking the **Port Editor** button.
3. Use the Quick search field to Find the ports to configure.
4. In th an Alias field enter a name to help identify the inline port.
5. For **Type**, select **Inline Tool**.

An Inline Tool represents a pair of inline tool ports.
6. Click **OK**.

Configure Inline Tool

An Inline Tool represents a pair of inline tool ports. To configure an Inline Tool, do the following:

1. Select **Inline Bypass > Inline Tools**.
2. Click **New**.
3. If needed, click **Port Editor** to open the Quick Port Editor to configure the inline tool ports.

4. Select the inline tool ports for the inline tool.
 - For **Port A**, select an inline tool port configured in the previous procedure, [Configure Inline Tool Ports](#).
 - For **Port B**, select another inline tool port configured in the previous procedure, [Configure Inline Tool Ports](#).
5. Select **Enabled** to set the inline tool ports as enabled for inline bypass traffic.
6. For **Failover action**, select one of the following:
 - **Tool Bypass** — When the inline tool fails all traffic coming to the respective inline tool is directed via the bypass path.
 - **Network Bypass** — When the inline tool fails the traffic is directed to multiple inline tools associated with an inline network or inline network group using rule-based inline maps.
 - **Tool Drop** — When the inline tool fails all traffic coming to the respective inline tool is dropped.
 - **Network Drop**—When the inline tool fails all traffic coming to the respective inline tool is dropped.
 - **Network Port Forced Down**—When the inline tool fails the inline network ports of the respective inline network are forced as "down".
7. Select the **Recovery Mode**. The recovery mode can be one of the following:
 - **automatic**—Specifies automatic recovery, which redirects traffic back to the inline tool as soon as it has recovered from all faulty conditions.
 - **manual**—Specifies manual recovery, which lets you control when to put an inline tool back into service after the tool has recovered. For example, you may want to wait for a maintenance window to return the inline tool to service.
8. Select **Enable Heartbeat** to set the heartbeat.

If the heartbeat is enabled, do the following:

 - a. From **Profile**, select the desired heartbeat profile. The available heartbeat profiles are existing profiles from other inline tools. Once a heartbeat profile is selected, its attributes are displayed.
 - b. In the **HB IP Address A** field, enter the server's IP address to send the heartbeat packets.
 - c. In the **HB IP Address B** field, enter the server's IP address to send a second heartbeat packet.
9. Click **Save**.

Create Inline Tool Group

An Inline Tool Group is an arrangement of multiple Inline Tools to which traffic is distributed based on calculated hash values used by Gigamon node.

To configure an Inline Tool Group, do the following:

1. Use the **Quick Port Editor** to configure the inline tool ports.
2. Select **Inline Bypass > Inline Tool Groups**.
3. Click **New**.
4. In the **Alias** field, enter a name to help identify the inline tool group.
5. For **Inline Tools**, select the inline tool ports for the inline tool group.
6. (Optional) For the **Inline Spare Tool**, select another inline tool port.

If a spare is selected, the inline tool group becomes a redundant arrangement of inline tools. When the first failure occurs in a set of active inline tools, traffic will be forwarded to the spare with no loss, thus the spare will replace the failed tool in the active set.

7. Select **Enable** to enable the inline tool group.
8. Select the **Failover Action**. The failover actions are:
 - **Tool Bypass**—When the inline tool group fails all traffic coming to the respective inline network is directed via the bypass path.
 - **Tool Drop**—When the inline tool group fails all traffic coming to the respective inline network is dropped.
 - **Network Bypass**—When the inline tool group fails all traffic coming to the respective inline network is directed to the inline tool group via the bypass path.
 - **Network Drop**—When the inline tool group fails all traffic coming to the respective inline network group is dropped.
 - **Network Port Forced Down**—When the inline tool group fails the inline network ports of the respective inline network are forced as "down".
9. For **Minimum Healthy Group Size**, select a number that represents the minimal amount of inline tools that are required to have a state of Normal.
10. Select the **Hash** for the inline tool group.

Hashing, which is used for distributing traffic across the inline tools in an inline tool group. The values for the hash parameter are as follows:

- **advanced**—Specifies symmetrical hashing, which is derived from the combination of packet fields based on the criteria selected for the advanced-hash algorithm. For inline bypass applications, the most common choice of criteria for the advanced-hash algorithm

is the combination of source IP and destination IP addresses. This produces a hash value that sends all traffic associated with the same session to the same inline tool in the inline tool group.

- **a-srcip-b-dstip**—Specifies asymmetrical hashing, which is derived from the source IP address for side A of the network and the destination IP address for side B of the network. This produces a hash value that sends all traffic associated with the same source address residing on side A to the same inline tool in the inline tool group, regardless of destination or session.
- **b-srcip-a-dstip**—Specifies asymmetrical hashing, which is derived from the destination IP address for side A of the network and the source IP address for side B of the network. This produces a hash value that sends all traffic associated with the same source address residing on side B to the same inline tool in the inline tool group, regardless of destination or session.

11. Click **Save**.

Configure Inline Tool Series

To configure an Inline Tool Series, do the following:

1. Select **Inline Bypass > Inline Serial Tools**.
2. Click **New**.
3. In the **Alias** field, enter a name to help identify the inline tool series.
4. For **Inline Tools**, select the inline tool ports for the inline tool series.
5. Select **Enabled** to enable this configuration.
6. Select the **Failover action**.

For details about the failover actions, refer to [Inline Tool Series Local Failover Action](#)

7. Select the **Per Direction Order**.

For details about per-direction order, refer to [Inline Tool Series Per-Direction Order](#).

Configure When GigaVUE HC Series Modules are Operationally Up

Ensure that the GigaVUE HC Series modules are in the operationally *up* state before configuring them. Configuration changes done when a module is operationally *down* are not supported.

Also, when an inline tool or inline tool group is in the operationally *down* state, do not modify the current failover action of that inline tool or inline tool group until the tool has recovered from the failover state.

Avoid Oversubscription

In general, traffic received at inline network ports is delivered to the destination ports according to the inline maps and the out-of-band maps regardless of whether the destination ports have the capacity to absorb all the traffic or not.

NOTE: When an inline network is involved in an inline map or an out-of-band map to a destination port (tool port or inline tool port), when there is temporary oversubscription, some packets arriving at the inline network port will be dropped. This can happen when the traffic path is set to bypass or monitoring.

Ensure that destination ports of maps originating from inline network ports have enough capacity to absorb the amount of traffic coming to the inline network ports.

Configure Gigamon Resiliency for Inline Protection

Gigamon Resiliency for Inline Protection (GRIP)[™] is an inline bypass solution that connects two GigaVUE nodes together so that one node provides high availability to the other node when there is a loss of power. This redundant arrangement of two GigaVUE nodes maintains traffic monitoring by inline tools when one of the nodes is down.

GRIP makes use of the bypass protection switch relays for protected inline networks on GigaVUE-HC3, GigaVUE-HC2, and GigaVUE-HC1 nodes. The following modules are required to provide physical protection:

- bypass combo modules (BPS), for a protected pair of optical inline network ports on GigaVUE-HC3, GigaVUE-HC2, or GigaVUE-HC1
- TAP-HC0-G100C0 module, for a protected pair of copper inline network ports on GigaVUE-HC2
- TAP-HC1-G10040 module, for a protected pair of copper inline network ports on GigaVUE-HC1

NOTE: GRIP is supported on GigaVUE-HC3 only when there are other modules installed in the node that can provide the stack link. The GRIP solution synchronizes the nodes through a signaling link using a stack link between two stack ports. The BPS-HC3-C25F2G module does not support stack ports, so another module such as PRT-HC3-C08Q08 or SMT-HC3-C05 must be available to be used for that purpose.

In the GRIP solution, two GigaVUE nodes are cabled so that traffic is guided through one GigaVUE node, acting in the primary role, while the other GigaVUE node is on standby, acting in a secondary role. If the primary node fails, the bypass protection switch relays on the modules switch the traffic over from the primary node to the secondary node.

Using the physical protection for either copper or fiber, traffic is guided through inline tools by one of the GigaVUE nodes. The GigaVUE node with the open bypass protection switch relays is the one through which traffic flows. The traffic only flows through one GigaVUE node or the other.

To configure the GRIP solution for copper, use two TAP-HC0-G100C0 modules on GigaVUE-HC2 or two TAP-HC1-G10040 modules on GigaVUE-HC1. The capacity will be 1Gb.

To configure the GRIP solution for fiber, use the following:

- two BPS-HC0-D25A4G, BPS-HC0-D25B4G, or BPS-HC0-D35C4G modules on GigaVUE-HC2. The capacity will be 10Gb.
- two BPS-HC1-D25A24 modules on GigaVUE-HC1. The capacity will be 10Gb.
- two BPS-HC0-Q25A28 modules on GigaVUE-HC2. The capacity will be 40Gb.
- two BPS-HC3-C25F2G modules on GigaVUE-HC3. The capacity will be either 100Gb or 40Gb, depending on the configured port speed of the inline network port pairs.

Between the two GigaVUE nodes, a 10Gb fiber signaling link is cabled using stack ports. Also, two inline tools are needed for the GRIP solution.

Refer to [Figure 322: Traffic Flows Through Node with Primary Role](#), [Figure 323: Traffic Flows Through Node with Secondary Role after Primary is Lost](#), and [Figure 324: Both Nodes Fail; No Traffic Monitoring](#).

[Figure 322: Traffic Flows Through Node with Primary Role](#) shows traffic coming from a network (for example, the Internet) through an edge router at the top of the figure. Two GigaVUE nodes with an inline monitoring tool attached to each node are shown in the middle of the figure. Traffic to end devices on a private network are shown at the bottom of the figure.

The GigaVUE node on the left of the figure is acting in the primary role, while the GigaVUE node on the right is acting in the secondary role. The nodes are synchronized through a signaling link using a stack link between two stack ports.

As shown in [Figure 322: Traffic Flows Through Node with Primary Role](#), traffic only flows through the node with the primary role. On the primary node, the bypass protection switch relays are open. Traffic is directed to the inline tool attached to the primary node. The node with the secondary role watches the state of the signaling link. If the primary node is up, the link is up, and the secondary

node takes no action. The bypass protection switch relays on the secondary node are in a closed state. In [Figure 322: Traffic Flows Through Node with Primary Role](#), the dotted lines depict the inactive traffic path.

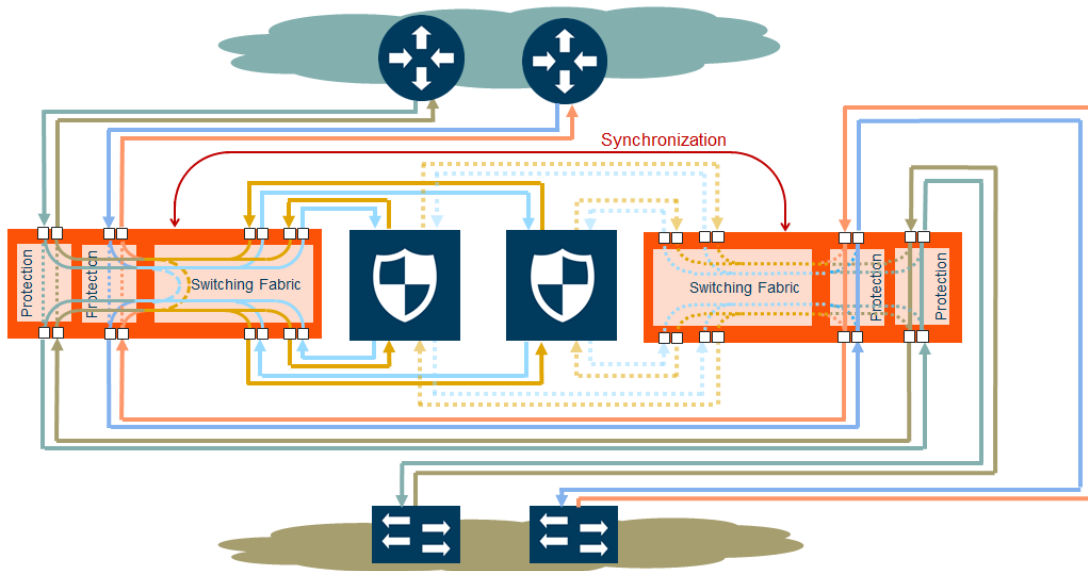


Figure 322: Traffic Flows Through Node with Primary Role

In [Figure 323: Traffic Flows Through Node with Secondary Role after Primary is Lost](#), power is lost to the GigaVUE node in the primary role. The bypass protection switch relays on the primary node close automatically when the node is down. The secondary node receives a signal through the signaling link that the primary node is down. The secondary node opens its bypass protection switch relays. Now traffic flows through the secondary node and traffic is directed to the inline tool attached to the secondary node.

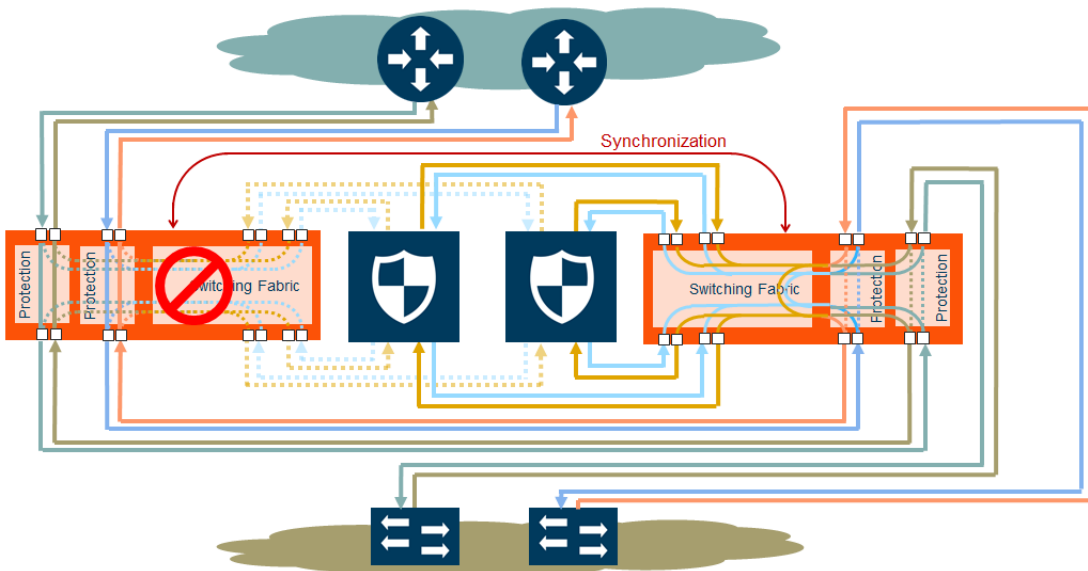


Figure 323: Traffic Flows Through Node with Secondary Role after Primary is Lost

In [Figure 324: Both Nodes Fail; No Traffic Monitoring](#), both nodes have lost power. The bypass protection switch relays are closed on both GigaVUE nodes. Traffic flows between the networks, but without going through the inline tools, which are both bypassed.

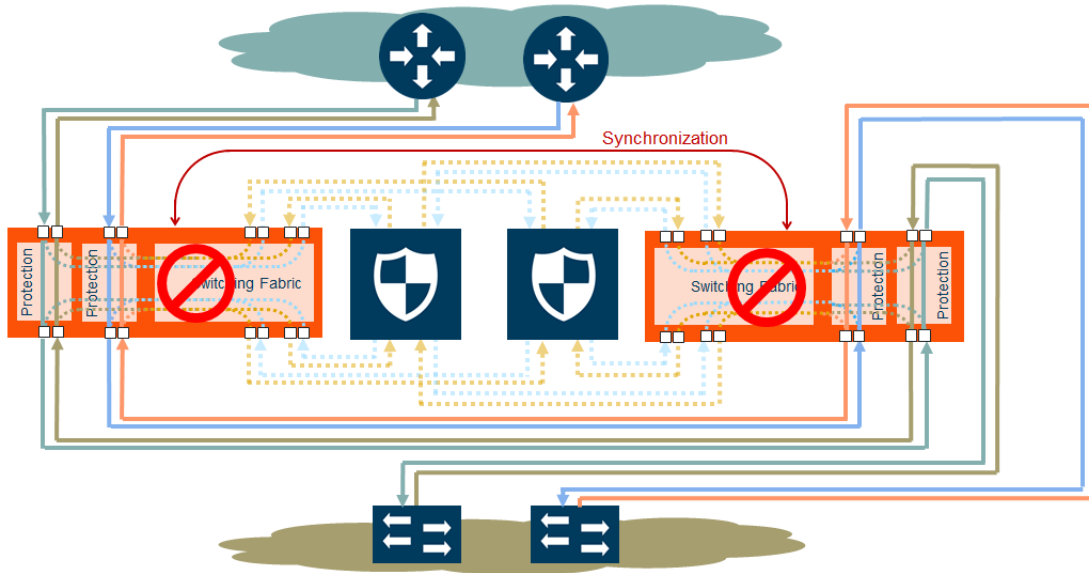


Figure 324: Both Nodes Fail; No Traffic Monitoring

How to Handle Recovery

In the scenario in [Figure 323: Traffic Flows Through Node with Secondary Role after Primary is Lost](#), after traffic is flowing through the secondary node, at some point the primary node will come back up. The primary node will establish the configured inline traffic paths, bring the signaling link up, and open its relays. Traffic will then flow through the primary node again.

Both Nodes Go Down and Only Secondary Comes Up

In the GRIP solution, if both primary and secondary nodes are powered down or if there is a power outage causing both primary and secondary nodes to go down, powering up the secondary alone without the primary ever coming up will cause network traffic to be bypassed instead of being sent to inline tools.

It is not recommended to power up/recover only the secondary node without the primary. The recommendation is to eventually bring the primary up also.

If the primary node is prone to failures or frequent power outages, another recommendation is to change the role of the secondary node to the primary.

How to Cable GigaVUE Nodes

To cable two GigaVUE nodes, as shown in [Figure 322: Traffic Flows Through Node with Primary Role](#) with the primary on the left and the secondary on the right:

- Connect the network shown at the top of [Figure 322: Traffic Flows Through Node with Primary Role](#) to inline network port A on the primary node.
- Connect inline network port B on the primary node to inline network port A on the secondary node.
- Connect inline network port B on the secondary node to the network shown at the bottom of the [Figure 322: Traffic Flows Through Node with Primary Role](#).
- Connect the signaling port on the primary node to the signaling port on the secondary node.

Configure Software

To configure the GRIP solution in software, first specify a name for a redundancy profile by selecting **Inline Bypass > Redundancies**, and then clicking **New**.

The redundancy profile specifies the following:

- **Signaling Port**—specifies the ports used to signal the state of the two GigaVUE nodes to each other. The ports provide the mechanism to detect loss of power in one of the GigaVUE nodes.
- **Protection Role**—specifies the role of the GigaVUE node, as primary, secondary, or suspended. The default is suspended. When suspended, the protection role is on hold. Changing a GigaVUE node from the primary role to the suspended role can be used to manually force the primary node down so the secondary node can become active. The suspended role is also used when performing maintenance. Refer to [Limitation for Suspended Role](#) and [How to Use Suspended Role for Maintenance](#).

The link between the signaling ports on the two GigaVUE-HC nodes is for synchronization. When the node acting in the primary role is up, the signaling link is up, and the node acting in the secondary role sees the link as up. When the primary node loses power, the signaling link is brought down, and the secondary node sees the link as down and takes over.

The redundancy profile combines the protection role with the signaling port. The same redundancy profile is applied to the inline networks, so they have the same properties. If multiple inline networks on each GigaVUE node share the signaling link, they must be configured with the same protection role.

The primary and secondary roles on the two GigaVUE nodes do not change. That is, the role of the primary node stays the same and the role of the secondary node stays the same. The secondary always watches the state of the signaling port for whether the link is up or down.

For example, in [Figure 323: Traffic Flows Through Node with Secondary Role after Primary is Lost](#), after the primary node recovers, it will open its bypass protection switch relays. Through the signaling port, the primary node will indicate that it is ready to receive traffic by setting the link state to up. The secondary node will notice that the link is up and will close its bypass protection switch relays. After recovery, the primary node automatically goes back into service.

Limitation for Suspended Role

Though GRIP is supported in a cluster, there is a limitation when the suspended protection role is used on the standby node in the cluster. The recommendation is to either switch the standby to the master or apply the suspended role in the redundancy profile to the master node.

Configure Synchronization

You must synchronize the configuration of the two GigaVUE nodes involved in the GRIP solution. The configuration items that must be synchronized are as follows:

- the signaling ports, as dictated by the signaling link cabling
- the inline networks, as dictated by the network path cabling between the two GigaVUE nodes
- the redundancy profiles. The redundancy profile of each GigaVUE nodes needs to have the same signaling port as well as a redundancy role that is compatible with the redundancy role on the other GigaVUE node. For example, one is configured with the primary role and one is configured with the secondary role.
- the inline tools
- the inline maps

For a configuration example of two GigaVUE-HC2 nodes, refer to [Example 4: Gigamon Resiliency for Inline Protection](#). In the example, the configuration is the same on both nodes, except for the protection role (primary or secondary).

Display Redundancy Control State

To display the Redundancy Control State, go to the Inline Networks page and click on the alias of the Inline Network for which you want to display the redundancy control state. The state is displayed on the Quick View under Configuration. [Figure 325: Redundancy Control State for Inline Network](#) shows an example where the inline network cu2 has a neutral redundancy control state.

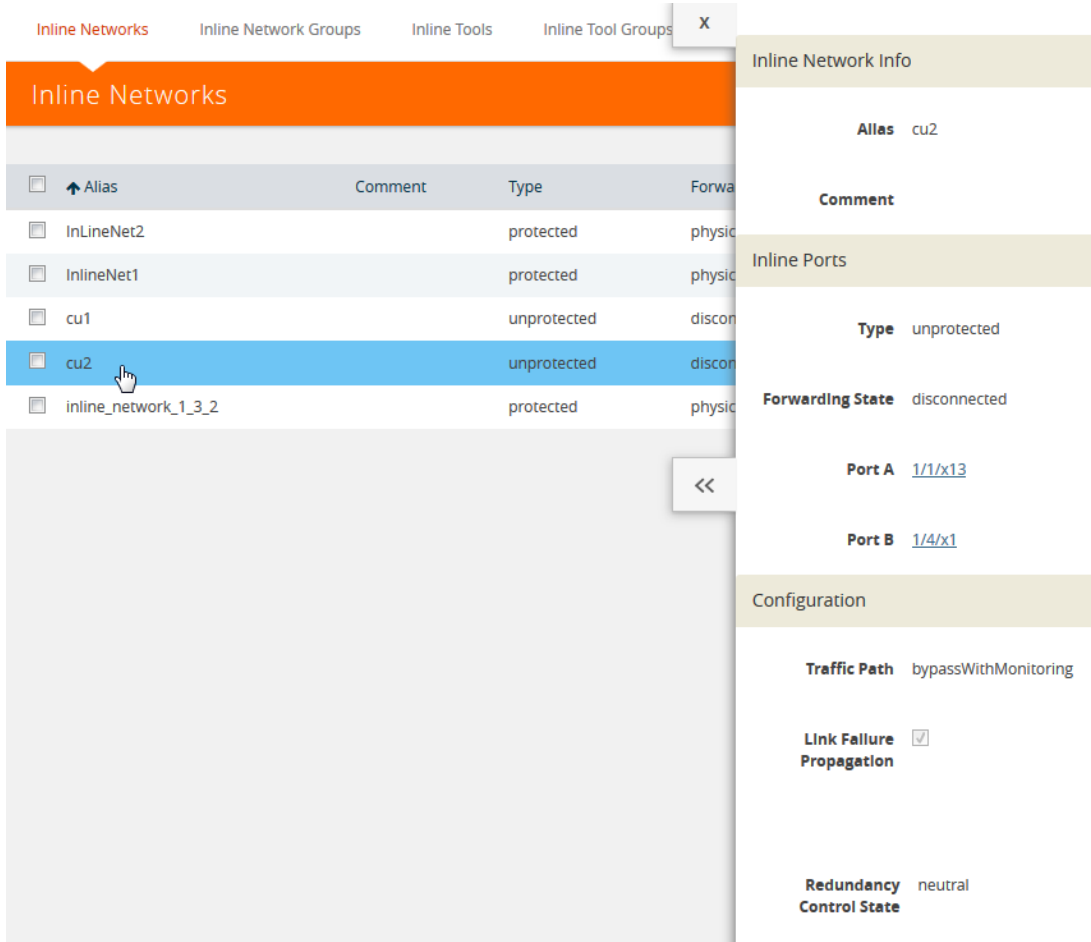


Figure 325: Redundancy Control State for Inline Network

Table 58: Redundancy Control States describes each

Table 58: Redundancy Control States

State	Description
Neutral	No redundancy profile is configured.
Suspended	The protection role is configured as suspended.
Primary Forwarding	The protection role is configured as primary. The node is acting in the primary role. Traffic flows through this node.
Secondary Bypass	The protection role is configured as secondary. The node is acting in the secondary role. Traffic bypasses this node.
Secondary Forwarding	The protection role is configured as secondary. The node is acting in the primary role due to a loss of power on the primary node. Traffic flows through this node.

redundancy control state.

How to Use Suspended Role for Maintenance

Use the suspended protection role to perform maintenance activities on the primary and secondary nodes. Maintenance activities include: bringing up a module, shutting down a module, or swapping a module.

For example, to remove a module on one of the GigaVUE-HC2 nodes, use the following steps on that module:

1. Select **Inline Bypass > Redundancies**.
2. On the Redundancies page, select the redundancy profile, and then click **Edit**.
3. For **Protection Role**, select **suspended**, and then click **Save**.

GRIP for Mixed Topologies

GRIP supports mixed topologies. The two nodes in the GRIP configuration do not both have to be the same GigaVUE HC Series nodes. For example, one node can be a GigaVUE-HC1 and the other node can be a GigaVUE-HC2. However the port speed on both nodes (10Gb) must match. In the current software version, GigaVUE-HC3 is not supported in a mixed topology with either GigaVUE-HC1 or GigaVUE-HC2.

Inline Bypass Solution Examples

The following sections provide examples of inline bypass solutions. The solutions are presented in an order from simple to complex. Refer to the following:

- [Example 1: Unprotected Inline Bypass with an Inline Tool Group](#)
- [Example 2: Unprotected Inline Bypass with Default Heartbeat](#)
- [Example 3: Protected Inline Bypass Using Combo Modules](#)
- [Example 4: Gigamon Resiliency for Inline Protection](#)

Example 1: Unprotected Inline Bypass with an Inline Tool Group

Example 1 is a simple, unprotected inline bypass solution. In the example, aliases are used for inline network ports (iN1 and iN2), inline tool ports (iT1 and iT2), inline network (inNet), inline tool (inTool), and inline map (inMap).

On GigaVUE-HC3, an unprotected inline bypass solution can be configured on the bypass combo module with the inline networks and inline tools on ports 1/1/x1..x16 or on ports c1..c4, or on any other module on the GigaVUE-HC3 node.

On GigaVUE-HC2, an unprotected inline bypass solution can be configured with the inline networks and inline tools on ports 1/1/x1..x16 or on ports x17..x24, or on any other module on the GigaVUE-HC2 node. Refer to [Figure 326: Logical Bypass Without Bypass Combo Module](#) which shows a GigaVUE-HC2.

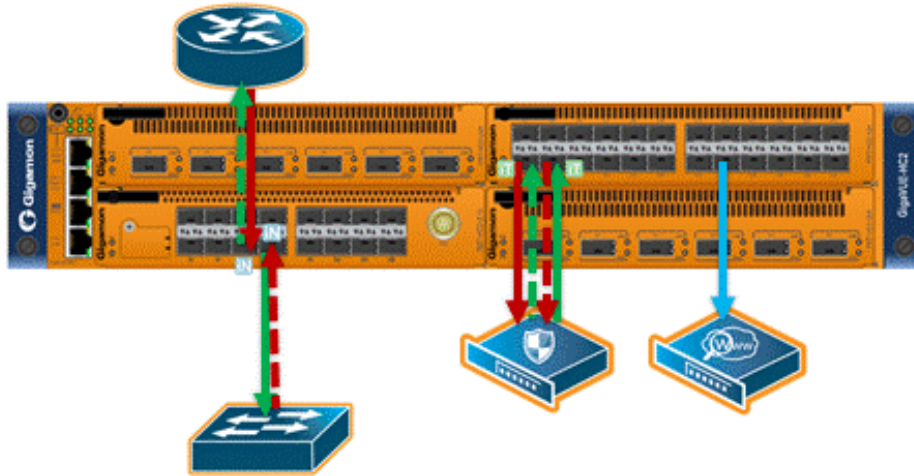


Figure 326: Logical Bypass Without Bypass Combo Module

On GigaVUE-HC1, an unprotected inline bypass solution can be configured on the base module, with the inline networks and inline tools on ports 1/1/x1..x12 and 1/1/g1..g4, or on the bypass combo module on ports x1..x4.

Task	Description	UI Steps
1.	Configure inline network aliases, port type (inline-network), and administratively enable inline network ports.	<ol style="list-style-type: none"> 1. Select Ports > All Ports. 2. Click Quick Port Editor. 3. Use Quick search to find the ports to configure. In this example, the ports are 3/1/x1 and 3/1/x2 4. Set port 3/1/x1 to Type Inline-Network and select Enable. Enter iN1 for the port alias. 5. Set port 3/1/x2 to Type Inline-Network and select Enable. Enter iN2 for the port alias. 6. Make sure Enable is selected for Admin on the ports. 7. Click OK.
2.	Configure inline network.	<ol style="list-style-type: none"> 1. Select Inline Bypass > Inline Networks. 2. Click New. 3. In the Alias field, type InNet. 4. For Port A, select iN1. 5. For Port B, select iN2. 6. Click Save.

Task	Description	UI Steps
3.	Configure inline tool ports, port type (inline-tool), and administratively enable inline tool ports.	<ol style="list-style-type: none"> 1. Select Ports > All Ports. 2. Click Quick Port Editor. 3. Use Quick search to find the ports to configure. In this example, the ports are 3/1/x3 and 3/1/x4 4. Set port 3/1/x4 to Type Inline-Tool and select Enable. Enter iT1 for the port alias. 5. Set port 3/1/x4 to Type Inline-Tool and select Enable. Enter iT2 for the port alias. 6. Make sure Enable is selected for Admin on the ports. 7. Click OK.
4.	Configure inline tool, and enable it. Also enable the default heartbeat profile.	<ol style="list-style-type: none"> 1. Select Inline Bypass > Inline Tools. 2. Click New. 3. In the Alias field, type InTool. 4. For Port A, select iT1. 5. For Port B, select li2. 6. Under Configuration: <ol style="list-style-type: none"> a. Select Enabled b. Select Enabled Heartbeat and set Profile to default. 7. Click Save.
5.	Configure map passall, from inline network to inline tool.	<ol style="list-style-type: none"> 1. Select Maps > Maps. 2. Click New. 3. In the Alias field, type InMap. 4. Select Inline for Type and Pass All for Subtype. 5. For Source, select InNet 6. For Destination, select InTool. 7. Click Save.
6.	Configure the path of the traffic to inline tool.	<ol style="list-style-type: none"> 1. Select Inline ByPass > Inline Networks. 2. Select the Inline Network InNet and click Edit 3. Under Configuration, set the Traffic Path field to To Inline Tool. 4. Click Save.

Example 2: Unprotected Inline Bypass with Default Heartbeat

Example 2 adds the default heartbeat profile to the unprotected inline bypass solution in Example 1.

Task	Description	UI Steps
1.	Configure inline network aliases, port type (inline-network), and	<ol style="list-style-type: none"> 1. Select Ports > All Ports. 1. Click Quick Port Editor.

Task	Description	UI Steps
	administratively enable inline network ports.	<ol style="list-style-type: none"> 2. Use Quick search to find the ports to configure. In this example, the ports are 3/1/x1 and 3/1/x2 3. Set port 3/1/x1 to Type Inline-Network and select Enable. Enter iN1 for the port alias. 4. Set port 3/1/x2 to Type Inline-Network and select Enable. Enter iN2 for the port alias. 5. Make sure Enable is selected for Admin on the ports. 6. Click OK.
2.	Configure inline network.	<ol style="list-style-type: none"> 1. Select Inline Bypass > Inline Networks. 7. Click New. 8. In the Alias field, type InNet. 9. For Port A, select iN1. 10. For Port B, select iN2. 11. Click Save.
3.	Configure inline tool ports, port type (inline-tool), and administratively enable inline tool ports.	<ol style="list-style-type: none"> 1. Select Ports > All Ports. 12. Click Quick Port Editor. 13. Use Quick search to find the ports to configure. In this example, the ports are 3/1/x3 and 3/1/x4 14. Set port 3/1/x4 to Type Inline-Tool and select Enable. Enter iT1 for the port alias. 15. Set port 3/1/x4 to Type Inline-Tool and select Enable. Enter iT2 for the port alias. 16. Make sure Enable is selected for Admin on the ports. 17. Click OK.
4.	Configure default heartbeat profile.	In GigaVUE-HVUE, the default heartbeat profile is already configured. To view the profile, select Inline Bypass > Heartbeats.
5.	Configure inline tools, and enable it. Also enable the default heartbeat profile.	<ol style="list-style-type: none"> 1. Select Inline Bypass > Inline Tools. 18. Click New. 19. In the Alias field, type InTool1. 20. For Port A, select iT1. 21. For Port B, select iT2. 22. Under Configuration: <ol style="list-style-type: none"> a. Select Enabled b. Select Enabled Heartbeat and set Profile to default. 23. Click Save.
6.	Configure map passall, from inline network to inline tool.	<ol style="list-style-type: none"> 1. Select Maps > Maps. 24. Click New. 25. In the Alias field, type InMap. 26. Select Inline for Type and Pass All for Subtype.

Task	Description	UI Steps
		<p>27. For Source, select InNet</p> <p>28. For Destination, select InTool.</p> <p>29. Click Save.</p>
7.	Configure the path of the traffic to inline tool.	<p>1. Select Inline ByPass > Inline Networks.</p> <p>30. Select the Inline Network InNet and click Edit</p> <p>31. Under Configuration, set the Traffic Path field to To Inline Tool.</p> <p>32. Click Save.</p>

Example 3: Protected Inline Bypass Using Combo Modules

Example 3 is a protected inline bypass solution using bypass combo modules on GigaVUE-HC2. It also configures heartbeat and negative heartbeat profiles.

Protected inline networks are based on the pairs of ports associated with the physical protection switches located on the bypass combo modules. Unlike the unprotected examples, you do not need to configure inline network ports because they are created automatically. On GigaVUE-HC2, the port pairs are numbered for example: 2/2/x17 and 2/2/x18, 2/2/x19 and 2/2/x20, 2/2/x21 and 2/2/x22, 2/2/x23 and 2/2/x24.

You do not need to configure inline networks because they are also created automatically on bypass combo modules. The aliases of the default inline networks are: default_inline_net_2_2_1, default_inline_net_2_2_2, default_inline_net_2_2_3, default_inline_net_2_2_4.

On GigaVUE-HC3, protected inline bypass can be configured on the bypass combo module on ports c1..c4.

On GigaVUE-HC1, protected inline bypass can be configured on the bypass combo module. It can also be configured on the TAP-HC1-G10040 module placed in either bay 2 or bay 3, so the ports will be 1/2/g1..g8 or 1/3/g1..g8.

NOTE: The default value of the physical-bypass attribute of protected inline networks is set to enable, which means that the fibers attached to ports net-a and net-b of the inline network are optically coupled and the traffic is exchanged between end nodes without coming to the switching fabric. of the GigaVUE node. As shown in Example 4, after configuring the inline tool and the map passall, the physical-bypass attribute is set to disable in order to activate the inline-bypass solution.

Task	Description	UI Steps
1.	Configure inline tool aliases, port type (inline-tool), and administratively enable inline network ports.	<ol style="list-style-type: none"> 1. Select Ports > All Ports. 1. Click Quick Port Editor. 2. Use Quick search to find the ports to configure. In this example, the ports are 2/2/x11 and 2/2/x12 3. Set port 2/2/x11 to Type Inline Tool and select Enable. Enter iT1 for the port alias. 4. Set port 2/2/x12 to Type Inline Tool and select Enable. Enter iT2 for the port alias. 5. Click OK.
2.	Configure a heartbeat profile.	<ol style="list-style-type: none"> 1. Select Inline Bypass > Heartbeats. 6. Click New. 7. In the Alias field, type hb2. 8. For Type, select Regular. 9. Click Save.
3.	Configure negative heartbeat profile alias and PCAP file	<ol style="list-style-type: none"> 1. Select Inline Bypass > Heartbeats. 10. Click New. 11. In the Alias field, type nhb1. 12. For Type, select Negative. 13. Click the Browse button for Custom Format and upload the pcap file; for example, hnb.pcap. 14. Click Save.
4.	Configure inline tools, and enable them. Also specify the heartbeat profile.	<ol style="list-style-type: none"> 1. Select Inline Bypass > Inline Tools. 15. Click New. 16. In the Alias field, type InTool1. 17. For Port A, select iT1. 18. For Port B, select iT2. 19. Under Configuration: <ol style="list-style-type: none"> a. Select Enabled b. Select Enabled Regular Heartbeat and set Profile to hb2. c. Select Enabled Negative Heartbeat and set Negative Heartbeat Profile to nhb1. 20. Click Save. <p>Configure the second inline tool.</p> <ol style="list-style-type: none"> 1. Select Inline Bypass > Inline Tools. 21. Click New. 22. In the Alias field, type InTool2. 23. For Port A, select iT3. 24. For Port B, select iT4.

Task	Description	UI Steps
		<p>25. Under Configuration:</p> <ul style="list-style-type: none"> a. Select Enabled b. Select Enabled Heartbeat and set Profile to hb_custom. <p>26. Click Save.</p>
5.	Configure the inline tool group and enable it.	<p>1. Select Inline Bypass > Inline Tool Group</p> <p>27. Click New.</p> <p>28. In the Alias field, type inToolGroup.</p> <p>29. For Inline Tools, select InTool1 and InTool2.</p> <p>30. Under Configuration, select Enabled.</p> <p>31. Click Save.</p>
6.	Configure map passall, from inline network to inline tool.	<p>1. Select Maps > Maps.</p> <p>32. Click New.</p> <p>33. In the Alias field, type InMap.</p> <p>34. Select Inline for Type and Pass All for Subtype.</p> <p>35. For Source, select default_inline_net_2_2_1</p> <p>36. For Destination, select InTool1</p> <p>37. Click Save.</p>
7.	Configure the path of the traffic to inline tool and disable the physical bypass	<p>1. Select Inline ByPass > Inline Networks.</p> <p>38. Select the Inline Network default_inline_net_2_2_1 and click Edit</p> <p>39. Under Configuration, set the Traffic Path field to To Inline Tool.</p> <p>40. Make sure Physical Bypass is not selected.</p> <p>41. Click Save.</p>

Example 4: Gigamon Resiliency for Inline Protection

Example 5 is an inline bypass solution for GRIP using TAP-HC0-G100C0 modules on the GigaVUE-HC2, with copper ports.

First, configure the GigaVUE-HC2 with the primary role, then configure the GigaVUE-HC2 with the secondary role. The configuration is the same (is synchronized) on both nodes, except for step 3, in which the protection role (primary or secondary) is specified.

Note that in this example, link fail propagation (LFP) is disabled to reduce inline network recovery time after failover. When a primary to secondary failover occurs and LFP is enabled for copper inline bypass links, network service recovery may take several seconds because of Ethernet link

renegotiation. Optical links failover faster and typically recover service much faster. For inline networks where only one path is available, this is a consideration. When GRIP is deployed with high availability networks where a second path is present, it is a best practice to leave LFP enabled.

You can use the Chassis page to view the chassis and modules.

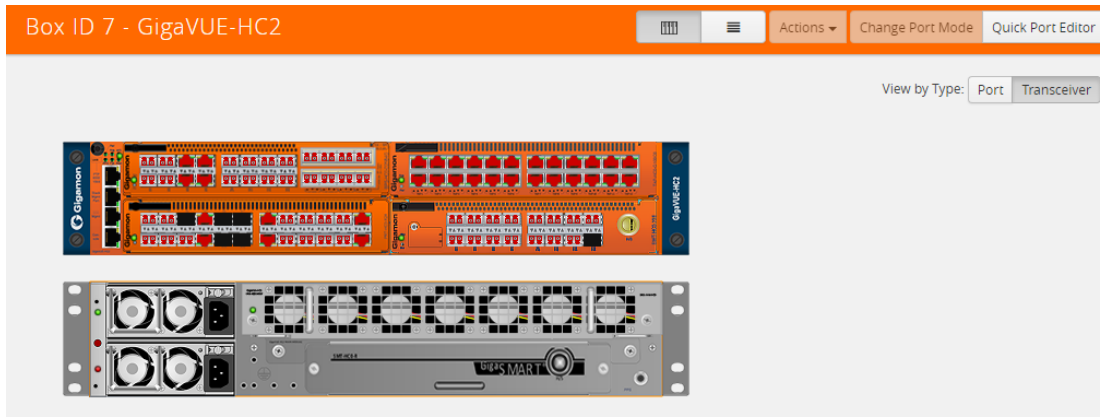


Figure 327: Chassis view of GigaVUE-HC2 with TAP-HC0-G100C0 Module

Configure Primary Role GigaVUE-HC2

Task	Description	UI Steps
1.	Configure ports on the TAP-HC0-G100C0 module as passive (in passive mode, relays are closed). Also configure ports, port type (inline-network).	<ol style="list-style-type: none"> Select Ports > Ports> All Ports. Select a port of the TAP-HC0-G100C0 module. Click to open the Ports page. Select Passive for TapTX Click Save. Repeat steps 2 through 6 for each port on the TAP-HC0-G100C0 module Configure Inline Network ports <ol style="list-style-type: none"> Select the port. Click Quick Port Editor. Select Inline Network for Type. <div style="border: 1px solid gray; padding: 5px; margin-top: 10px;"> <p>NOTE: You can use the Chassis page to locate the position of the module in the chassis and identify port IDs.</p> </div>
2.	Configure stack port (for signaling port/link) and enable it.	<ol style="list-style-type: none"> Select the port and click Edit. Select Enable for Admin. Select Stack for Type. Click OK.
3.	Create the redundancy profile by giving it a name and configuring parameters for the redundancy profile such as the	<ol style="list-style-type: none"> Select Inline Bypass > Redundancies Click New. Enter a name for the profile in the Alias field. For example,

Task	Description	UI Steps
	signaling port and protection role (primary).	<p>RP_001.</p> <ol style="list-style-type: none"> 13. Click in the Signaling Port field and select the stack port configured in Task 2. 14. Select Primary for Protection Role. 15. Click Save.
4.	<p>Configure inline network.</p> <p>This step associates the redundancy profile to the inline network and also disables link fail propagation on the inline network.</p>	<ol style="list-style-type: none"> 1. Select Inline Bypass > Inline Tools. 16. Click New. 17. Enter a name for the inline network in the Alias field. For example, IN_001. 18. Click in the Port A field and select inline network port for network A. 19. Click in the Port B field and select an inline network port f. 20. Select Bypass for Traffic Path. (This is the default setting.) 21. Make sure Link Failure Propagation option is NOT checked. (It is enabled by default.) 22. Click in the Redundancy Profile field and select the profile created in step 3. For example RP_001.
5.	Configure inline tool ports, port type (inline-tool), and administratively enable them.	<ol style="list-style-type: none"> 1. Select Ports > Ports > All Ports. 23. Select the first port (for example, 1/4/x1) to configure as an inline-tool port. 24. Click Quick Port Editor. 25. Select Inline Network for Type and select Enable for Admin. 26. Click OK. 27. Select the second port (for example, 1/4/x2) and repeat steps 3 through 5.
6.	Configure inline tool and failover action. then enable inline tool.	<ol style="list-style-type: none"> 1. Select Inline Bypass > Inline Tools 28. Enter a name for the inline tool in the Alias field. For example, IT_001 29. Click in the Port A field and select the first inline tool port configured in Task 5. 30. Click in the Port B field and select the second inline tool port configured in Task 5. 31. Make sure Enable is selected. (It is enabled by default) 32. Select NetworkBypass for Failtover action. 33. Click Save.
7.	<p>Configure map passall, from inline network to inline tool.</p> <div style="border: 1px solid gray; padding: 5px; margin-top: 10px;"> <p>NOTE: When you delete a map on the primary node, irrespective of the</p> </div>	<ol style="list-style-type: none"> 1. Select Maps > Maps > Maps. 2. Click New. 3. Enter a name for the map in the Alias field. For example, INtoIT. 4. Select Regular for Type.

Task	Description	UI Steps
	inline-network traffic-path, the traffic is switched to the secondary node. The port utilization must be 0% on the primary node and active on the secondary node.	<ol style="list-style-type: none"> 5. Select Pass All for Subtype. 6. Select the inline network created in Task 4 for Source. For example, IN_001. 7. Select the inline tool created in Task 6. For example, IT_001.

Configure Secondary Role GigaVUE-HC2

Task	Description	UI Steps
1.	Configure ports on the TAP-HC0-G100C0 module as passive (in passive mode, relays are closed). Also configure ports, port type (inline-network).	<ol style="list-style-type: none"> 1. Select Ports > Ports> All Ports. 8. Select a port of the TAP-HC0-G100C0 module. 9. Click to open the Ports page. 10. Select Passive for TapTX 11. Click Save. 12. Repeat steps 2 through 6 for each port on the TAP-HC0-G100C0 module 13. Configure Inline Network ports <ol style="list-style-type: none"> a. Select the port. b. Click Quick Port Editor. n. Select Inline Network for Type. <p>NOTE: You can use the Chassis page to locate the position of the module of the module in the chassis and identify port IDs</p>
2.	Configure stack port (for signaling port/link) and enable it.	<ol style="list-style-type: none"> 1. Select the port and click Edit. 15. Select Enable for Admin. 16. Select Stack for Type. 17. Click OK.
3.	Create the redundancy profile by giving it a name and configuring parameters for the redundancy profile such as the signaling port and protection role (secondary).	<ol style="list-style-type: none"> 1. Select Inline Bypass > Redundancies 18. Click New. 19. Enter a name for the profile in the Alias field. For example, RP_001. 20. Click in the Signaling Port field and select the stack port configured in Task 2. 21. Select Secondary for Protection Role. 22. Click Save.
4.	Configure inline network. This step associates the redundancy profile to the inline network and also disables link fail propagation on the inline network.	<ol style="list-style-type: none"> 1. Select Inline Bypass > Inline Tools. 23. Click New. 24. Enter a name for the inline network in the Alias field. For example, IN_001.

Task	Description	UI Steps
		<ol style="list-style-type: none"> 25. Click in the Port A field and select inline network port for network A. 26. Click in the Port B field and select an inline network port f. 27. Select Bypass for Traffic Path. (This is the default setting.) 28. Make sure Link Failure Propagation option is not checked. (It is enabled by default.) 29. Click in the Redundancy Profile field and select the profile created in step 3. For example RP_001.
5.	Configure inline tool ports, port type (inline-tool), and administratively enable them.	<ol style="list-style-type: none"> 1. Select Ports > Ports > All Ports. 30. Select the first port (for example, 1/4/x1) to configure as an inline-tool port. 31. Click Quick Port Editor. 32. Select Inline Network for Type and select Enable for Admin. 33. Click OK. 34. Select the second port (for example, 1/4/x2) and repeat steps 3 through 5.
6.	Configure inline tool and failover action, then enable inline tool.	<ol style="list-style-type: none"> 1. Select Inline Bypass > Inline Tools 35. Enter a name for the inline tool in the Alias field. For example, IT_001 36. Click in the Port A field and select the first inline tool port configured in Task 5. 37. Click in the Port B field and select the second inline tool port configured in Task 5. 38. Make sure Enable is selected. (It is enabled by default) 39. Select NetworkBypass for Failtover action. 40. Click Save.
7.	Configure map passall, from inline network to inline tool.	<ol style="list-style-type: none"> 1. Select Maps > Maps > Maps. 41. Click New. 42. Enter a name for the map in the Alias field. For example, INtoIT. 43. Select Regular for Type. 44. Select Pass All for Subtype. 45. Select the inline network created in Task 4 for Source. For example, IN_001. 46. Select the inline tool created in Task 6. For example, IT_001.
8.	Configure the path of the traffic to the inline tool, disabling physical bypass on the inline network to open the relay on the node with the primary role.	<ol style="list-style-type: none"> 1. Select Inline Bypass > Inline Networks. 47. Select the Inline Network configured in Task 4 and click Edit. 48. Select To Inline Tool for Traffic Path 49. Make sure Physical Bypass is NOT checked. 50. Click Save.

Timestamps

This chapter describes how to use the timestamp feature. The timestamp feature provides accurate time information to measure application and network performance.

Required License: Advanced Feature License

Refer to the following sections for details:

- [About Timestamps](#)
- [Using Timestamps](#)
- [Why PTP?](#)
- [Using PTP to Timestamp Packets](#)
- [Enabling Timestamp on a Port](#)
- [Viewing PTP Details](#)
- [PTP and Timestamp—Rules and Notes](#)

About Timestamps

Timestamps provide high-definition timing information for installations where packet timing is critical, particularly in high frequency trading, financial, and service provider environments. Timestamps are easily correlated across worldwide installations, improving your ability to monitor latency, Quality of Service (QoS), jitter, and end-to-end network performance across multiple instrumentation points.

This feature provides you the ability to append timestamps to ingress or egress packets. Timestamps are used in conjunction with Precision Time Protocol (PTP) for synchronization with a UTC reference clock.

You can choose to append timestamps to ingress packets, or to egress packets, or to both ingress and egress packets. [Figure 328: Timestamping](#) illustrates how timestamps are added to ingress and egress packets.

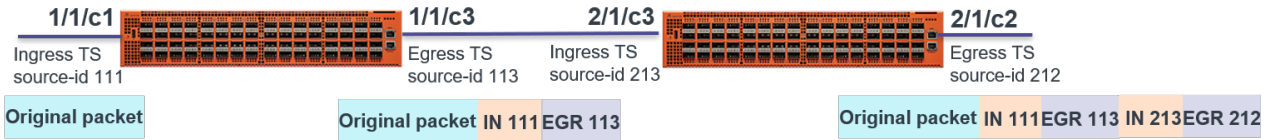


Figure 328: Timestamping

In this figure, the original packet is ingress timestamped on the 1/1/c1 port in a GigaVUE-TA200 device and egress timestamped on the 1/1/c3 port. The packet is then forwarded to the next device, where ingress and egress timestamps are again added at the 2/1/c3 and 2/1/c2 ports respectively. Thus, the packet has both ingress and egress timestamps with unique source IDs for each port, appended to its header. The source IDs provide port identification where timestamp is applied. You can add a maximum of two timestamps for a packet in a device.

Timestamp Format

When you enable the timestamp feature in a port, it appends a 14-byte trailer to each packet with a Source ID, Timestamp, Rx/Tx, and Recalculated CRC. If you have two timestamps added to the packet, the Recalculated CRC will be common for both the timestamps. The timestamp header will be 24-byte. [Figure 329: Timestamp Format](#) illustrates how an ingress packet is appended with a timestamp header.

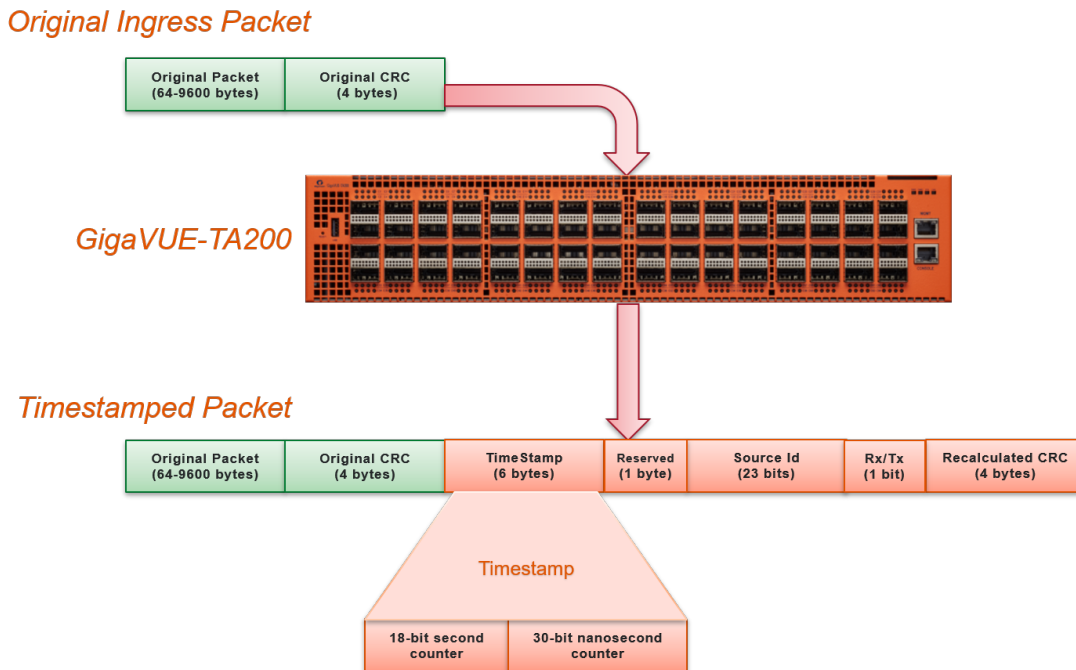


Figure 329: Timestamp Format

Using Timestamps

You must perform the following tasks to use the timestamp feature:

S. No	Task	Using GigaVUE-FM, Refer to:	Using GigaVUE-OS CLI, Refer to:
1.	Select PTP as the time synchronization source for your device. Using PTP, you can synchronize distributed clocks with nanoseconds accuracy.	Configuring PTP Globally	<i>"ptp" command section in the "GigaVUE-OS-CLI Reference Guide"</i>
2.	After you enable PTP on the required network port, check the port's PTP clock state, PTP configuration, and the synchronization status.	Viewing the PTP Configuration on a Port	<i>"Related Commands" section under the "ptp" command section in the "GigaVUE-OS-CLI Reference Guide"</i>
3.	Enable timestamp on the required ports. You can add timestamps to ingress or egress packets, or to both the packets.	Enabling Timestamp on a Port	<i>"port" command section in the "GigaVUE-OS-CLI Reference Guide"</i>
4.	View the PTP statistics for troubleshooting purposes.	Viewing PTP Details	<i>"Related Commands" section under the "ptp" command section in the "GigaVUE-OS-CLI Reference Guide"</i>

Why PTP?

PTP is a time synchronization protocol defined in IEEE 1588 version 2 (ITU-T G.8275.1) for devices across a network. Using PTP, you can synchronize distributed clocks with nanoseconds accuracy. The clocks in the PTP-enabled devices follow a master-slave hierarchy. The slaves are synchronized to their masters. The top-level master is called the grandmaster. The grandmaster clock is synchronized with a Global Positioning System (GPS).

The master will send a synchronization message to the slave. In turn, the slave sends a delay request to the master and the master reverts with a delay response. Thus, the delay is measured and the clock of the slave is synchronized with the master. This is also called as the one-step synchronization.

PTP-enabled devices can have the following clock modes:

- Ordinary clock— A clock that has only one PTP-enabled port and maintains the timescale used in the domain. It can serve either as a master or a slave.
- Boundary clock—A clock that has multiple PTP-enabled ports and maintains the timescale used in the domain. The ports can serve either as a master or a slave.

The Best Master Clock (BMC) algorithm that is run on every clock is used to determine the best clock in a distributed network. The algorithm compares the attributes from two different clocks to determine the data that describes the better clock. The algorithm is used to determine which of the clocks described in the announce messages received by a local clock port is the best clock. It is also used to determine whether a newly discovered clock, which is a foreign master, is better than a local clock. For more information on the BMC algorithm, refer to the ITU-T G.8275.1 standard.

Figure 330: PTP Deployment shows an example of a distributed network, in which the PTP-enabled devices work in a master-slave hierarchy.

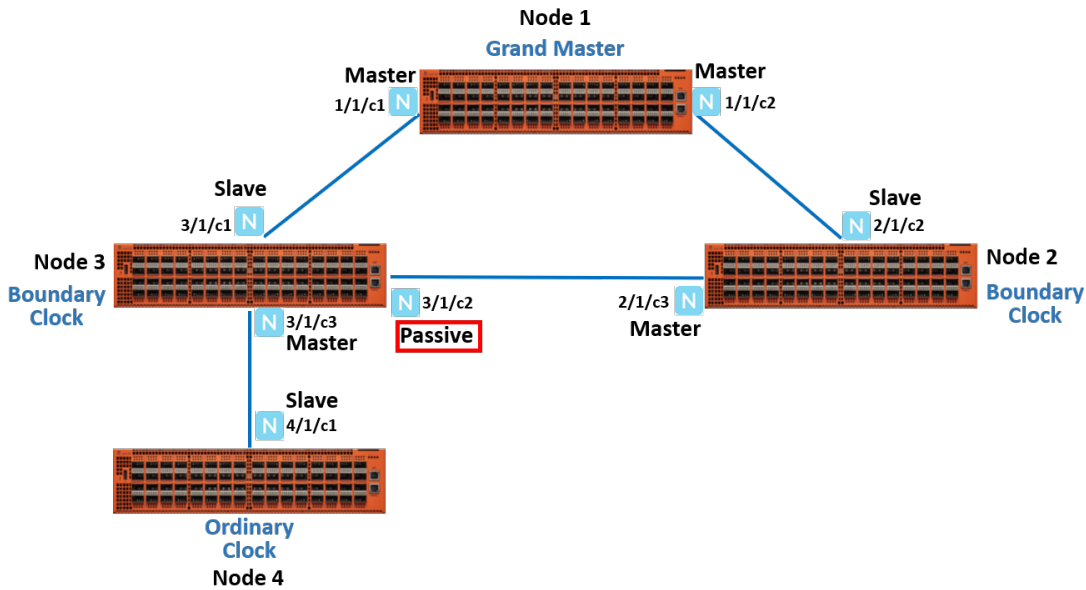


Figure 330: PTP Deployment

In this example, you have node 1, which is a top-level device that acts as a grandmaster. This device is linked to node 2 and node 3, which are boundary clocks. Node 3, in turn is linked to node 4, which is an ordinary clock. All these devices are synchronized in a master-slave hierarchy. Node 3 is synchronized with the grandmaster through the network port, 3/1/c1, which acts as a slave. The other port 3/1/c2 on node 3 is in passive state. When the link between the grandmaster and node 3 goes down, the network port, 3/1/c2, which was in the passive state transitions to slave state. This will ensure that node 3 as well as node 4 remain synchronized with the grandmaster through node 2 (refer to Figure 331: PTP State Transition).

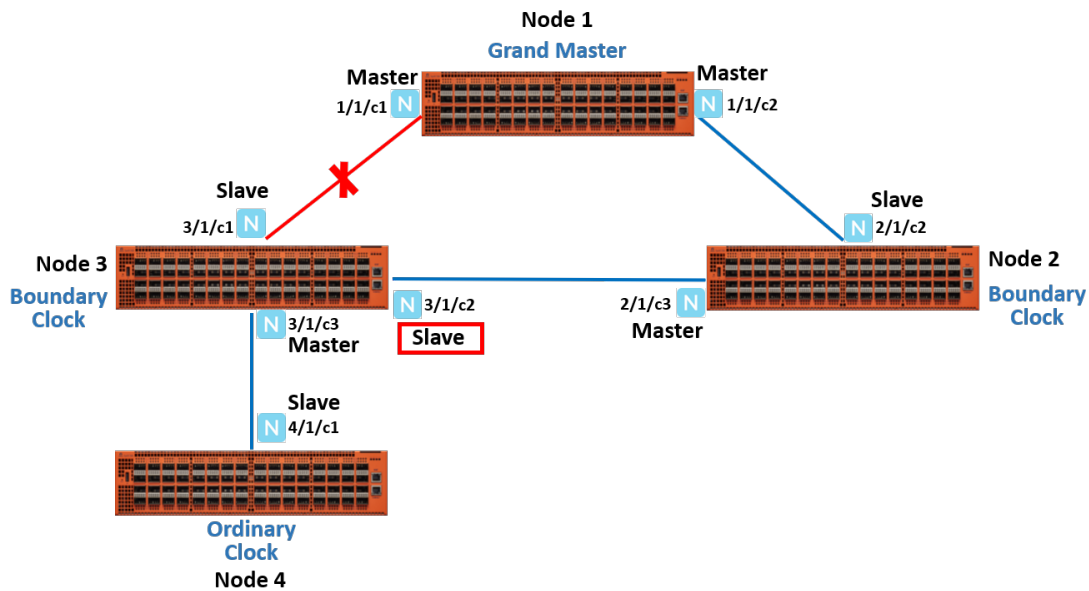


Figure 331: PTP State Transition

Using PTP to Timestamp Packets

Refer to the following sections about how to configure and enable PTP on the network ports to timestamp packets:

- [Configuring PTP Globally](#)
- [Enabling PTP on a Network Port](#)

Configuring PTP Globally

You must configure PTP globally on a device. You can configure the PTP domain, clock mode, and priority at the device level. Based on these PTP parameters, the grandmaster will be selected from the clocks in a network.

To configure PTP globally:

1. On the top-navigation link, go to **Physical > Physical Nodes**.
2. In the Physical Nodes page, click the required cluster ID for which you want to configure PTP.
3. On the left-navigation pane, go to **System > Settings > Date and Time > PTP**.
4. Click **New** to open the PTP page.

5. In the **Alias** field, enter a unique name for the PTP template that you are configuring globally on the device. Ensure that you provide a unique name for each device in the cluster. You can also choose to leave the field blank and a default alias will be added automatically. For example, `ptp_default_<box_id>`.
6. From the **Box ID** drop-down list, select the box ID of the device for which you want to configure PTP.
7. In the **Domain** field, enter a PTP domain number that will be used for this clock. The valid range is between 24 and 43. The default is 24.
8. From the **Mode** drop-down list, select **Boundary** or **Ordinary** as the clock mode. The default is **Boundary**.
9. In the **Priority 2** field, enter a priority value that will be used to determine the grandmaster in a network. For example, if there are two clocks in a network that match the default criteria, the clock that has the lower priority value will be selected as the grandmaster. The valid range is between 0 and 255. The default is 128.
10. In the **Local Priority** field, enter a priority value that will be used to determine the PTP master when the BMC algorithm chooses more than one clock as the master. This value overrides the default criteria for the BMC selection. The clock with the lower priority value will be selected.
For example, on a particular device, the local priority of a port is compared with the local priority of the clock. Based on the following criteria, the master is determined:
 - If the local priority of the port is greater than the local priority of the clock, the clock becomes the master.
 - If the local priority of the port is lesser than the local priority of the clock, the port becomes the master.
 - If the local priority of the port is equal to the local priority of the clock, the clock identity of the port and the clock is compared and the one that has the lower value becomes the master.

The valid range is between 1 and 255. The default is 128.

11. Click **OK**.

Enabling PTP on a Network Port

After you configure PTP globally on a device, you must enable PTP on the required network ports. You can also use the fanout ports to configure PTP. Once you have enabled PTP on a port, you cannot use the port for any other services such as maps. To configure PTP on a network port:

1. On the top-navigation link, go to **Physical > Physical Nodes**.

2. In the Physical Nodes page, click the required cluster ID for which you want to configure timestamp.
3. On the left-navigation pane, go to **Ports > Ports > All Ports**.
4. Select a network port on which you want to enable PTP, and then click **Edit**.
5. Scroll down to the PTP section, and then select the **Enable** check box.
6. In the **Local Priority** field, enter a priority value that will be used to determine the PTP master when the BMC algorithm chooses more than one clock as the master. This value overrides the default criteria for the BMC selection. The clock with the lower priority value will be selected.

For example, on a particular device, the local priority of a port is compared with the local priority of the clock. Based on the following criteria, the master is determined:

- If the local priority of the port is greater than the local priority of the clock, the clock becomes the master.
- If the local priority of the port is lesser than the local priority of the clock, the port becomes the master.
- If the local priority of the port is equal to the local priority of the clock, the clock identity of the port and the clock is compared and the one that has the lower value becomes the master.

The valid range is between 1 and 255. The default is 128.

7. From the **Role** drop-down list, select one of the following options:
 - **Master**—The port will act as the master with which all the connected ports with slave role will be synchronized.
 - **Slave**—The port will act as the slave and will be synchronized with the master port to which it is connected.
 - **Standard**—The BMC algorithm will determine the port's role as master or slave.

NOTE: The default is **Standard**.

8. In the **Announce Interval** field, enter the time interval, in seconds on a logarithmic scale, between PTP announce messages in the port. The valid range is between -3 and 4 log seconds. The default is -3.
9. In the **Delay Request Interval** field, enter the minimum interval allowed between PTP delay request messages. The valid range is between -7 and -1 log seconds. The default is -4.
10. In the **Sync Interval** field, enter the time interval between PTP synchronization messages on the port. The valid range is between -7 and -1 log seconds. The default is -4.
11. In the **VLAN** field, enter the PTP VLAN value for the port. The valid range is between 4080 and 4089. The default is 4080.

- Click **OK** to save the configuration.

Enabling Timestamp on a Port

You can configure ingress timestamp, egress timestamp, or both ingress and egress timestamps on a port. Refer to [Configuring PTP Globally](#) for the ports that are supported for timestamps.

To configure timestamp on a port:

- On the top-navigation link, go to **Physical > Physical Nodes**.
- In the Physical Nodes page, click the required cluster ID for which you want to configure timestamp.
- On the left-navigation pane, go to **Ports > Ports > All Ports**.
- Select a port on which you want to configure timestamp, and then click **Edit**.
- Scroll down to the Timestamp section.
- Select the **Enable** check box corresponding to the **Ingress** or **Egress** fields.
- In the **Source ID** field, enter a unique ID for the ingress or egress timestamp. The packets that ingress or egress the port will be timestamped with this unique source ID. The source ID enables you to identify the port on which the timestamp is applied.
- Click **OK** to save the configuration.

▼ Timestamp

Ingress	<input checked="" type="checkbox"/> Enable	Source ID	0	?
Egress	<input checked="" type="checkbox"/> Enable	Source ID	0	?

Figure 332: Timestamp Configuration

After you enable timestamp on the various ports, you can view the timestamp details for a list of ports in the Timestamp page. To view this page, go to **Settings > Date and Time > Timestamp**.

Viewing PTP Details

Following table provides information about the different PTP details that you can view:

To view:	Refer to:
The PTP configuration on a port	Viewing the PTP Configuration on a Port
The PTP clock details such as the	Viewing the PTP Clock Details

To view:	Refer to:
local PTP clock, parent clock state, and the time property for a device	
The PTP details of the master that is learned by a port	Viewing the PTP Foreign Master Details
The PTP statistics	Viewing PTP Statistics

Viewing the PTP Configuration on a Port

After you enable PTP on a network port, you can view the port's clock state and other details of PTP configuration in the PTP Port State page. To view the page, go to **Settings > Date and Time > PTP Port State**. [Figure 333: PTP Port State](#) shows the PTP configuration details.

Total Ports: 4 | Filtered By: None

<input type="checkbox"/>	Port ID/Port Alias	Box ID	Clock Identity	Delay Request Interval	Clock Port State	Local Pr...	Peer Delay Request Interval	Sync Interval	Announ...	Announ...	VLAN ID	Clock P...	PTP Ver...	Delay Mecha...	Peer Me
<input type="checkbox"/>	1/1/e13	1	00:1d:ac:00:00:66:0a:30	-4	MASTER	128	-4	-4	-3	3	4082	1	v2	endToEnd	0
<input type="checkbox"/>	1/1/e29	1	00:1d:ac:00:00:66:0a:30	-4	MASTER	128	-4	-3	-3	3	4081	2	v2	endToEnd	0
<input type="checkbox"/>	2/1/e29	2	00:1d:ac:00:00:66:1a:70	-4	SLAVE	128	-4	-3	-3	3	4081	1	v2	endToEnd	0
<input type="checkbox"/>	3/1/e13	3	00:1d:ac:00:00:66:4a:30	-4	SLAVE	128	-4	-4	-2	3	4082	1	v2	endToEnd	0

Figure 333: PTP Port State

Following table lists the PTP port states and their descriptions:

PTP Port State	Description
Port ID/Port Alias	The identifier of the port on which PTP is enabled.
Box ID	The box identifier of the device.
Clock Identity	The clock identity of the device. It is a 64-bit global identifier (EUI-64) as defined by the IEEE standard.
Delay Request Interval	The minimum interval allowed between PTP delay request messages when the port is in the master state.
Clock Port State	Based on the role defined for the port, the clock state will be Master or Slave. Following are the clock port states: <ul style="list-style-type: none"> • Initializing—The port is initializing its datasets, hardware, and communication facilities. The port does not place any PTP messages on its communication path during this state. If one port on the boundary clock is in the Initializing state,

PTP Port State	Description
	<p>all the other ports on the boundary clock will also be in the same state.</p> <ul style="list-style-type: none"> • Listening—Only signaling messages or management messages that are responses to another management message are placed on the port's communication path. • Faulty—The fault state of the protocol. Only signaling messages or management messages that are responses to another management message are placed on the port's communication path. In a boundary clock, any activity on the port with the Faulty clock port state does not affect the other ports in the device. If any activity on the faulty port is not restricted to the port, all other ports in the device changes to the Faulty state. • Disabled—The port does not place any messages on it's communication path. In a boundary clock, the port's activity does not affect the activity in other ports that are part of the boundary clock. A port in this state discards all PTP received messages except the management messages. • Pre-master—The port acts like a master but does not place any messages on it's communication path, except for signaling or management messages. • Master—The port becomes the master. • Passive—The port does not place any messages on it's communication path. • Uncalibrated—One or more master ports are detected in the domain. The appropriate master port has been selected, and the local port is preparing to synchronize to the selected master port. This is a transient state to initiate the servo

PTP Port State	Description
	<p>synchronization, datasets updates, and other implementation-specific activities.</p> <ul style="list-style-type: none"> • Slave—The port is synchronizing to the selected master port.
Local Priority	<p>The priority value used to determine the PTP master when the BMC algorithm chooses more than one clock as the master. This value overrides the default criteria for the BMC selection. The clock with the lower priority value will be selected. The valid range is between 1 and 255.</p> <p>For example, on a particular device, the local priority of a port is compared with the local priority of the clock. Based on the following criteria, the master is determined:</p> <ul style="list-style-type: none"> • If the local priority of the port is greater than the local priority of the clock, the clock becomes the master. • If the local priority of the port is lesser than the local priority of the clock, the port becomes the master. • If the local priority of the port is equal to the local priority of the clock, the clock identity of the port and the clock is compared and the one that has the lower value becomes the master.
Peer Delay Request Interval	The minimum interval allowed between PTP delay request messages between peer ports.
Sync Interval	The time interval between PTP synchronization messages on the port.
Announce Interval	The time interval, in log seconds, between PTP announce messages in the port.
Announce Receipt Timeout	The maximum number of consecutive announce messages that the port fails to receive. When the number of consecutive announce messages that the port failed to receive is greater than the value specified in this field, the port's clock state changes to master.
VLAN ID	The identifier of the VLAN interface.
Clock Port ID	The port identifier assigned by the PTP clock.
PTP Version	The PTP version that is enabled in the port.

PTP Port State	Description
Delay Mechanism	<p>The mechanism used to determine the delay between a master and a slave. Following is the delay mechanism that Gigamon supports:</p> <ul style="list-style-type: none"> • End-to-End—The master and the slave send delay requests and delay responses back and forth between themselves to measure the delay. Once the delay is measured, the slave synchronizes the time with the master.
Peer Mean Path Delay	Reserved for future use.

Viewing the PTP Clock Details

Use the PTP Clock page to view the local PTP clock, parent clock state, and the time property for the devices for which you have configured PTP. To view this page, go to **Settings > Date and Time > PTP Port State**. [Figure 334: PTP Clock Details](#) shows the PTP clock details.

Local PTP Clock																
Alias	Box ID	Clock Ident...	Ptp Time(s...	Mean Path...	Steps Re...	Domain	Offset Fro...	Priority2	Mode	Port Ptp C...	Clock Qua...	Step Type	Local Cloc...	Local Prio...	Clock Qua...	Clock Qua...
ptp1	1	00:1d:ac0...	19412.248...	0.0000000...	0	40	0(ns)	128	boundary	10	25us	oneStep	2019-02-2...	128	248	1
ptp2	2	00:1d:ac0...	19412.303...	0.0000001...	1	40	-270787(ns)	128	ordinary	1	25us	oneStep	2019-02-2...	128	248	1
ptp3	3	00:1d:ac0...	19412.359...	0.0000001...	1	40	-176321(ns)	128	ordinary	1	25us	oneStep	2019-02-2...	128	248	1

Page: 1 1 - 3 of 3

Parent Clock State												
*GM- Grandmaster												
Alias	Box ID	Clock Identity	GM Clock Identity	GM Priority1	GM Priority2	Observed Offset	Clock PortID	Stats	Observed Phas...	GM Clock Qualit...	GM Clock Qualit...	GM Clock Qualit...
ptp1	1	00:1d:ac:00:00:...	00:1d:ac:00:00:...	128	128	0	0	false	0	25us	248	1
ptp2	2	00:1d:ac:00:00:...	00:1d:ac:00:00:...	128	128	0	2	false	0	25us	248	1
ptp3	3	00:1d:ac:00:00:...	00:1d:ac:00:00:...	128	128	0	1	false	0	25us	248	1

Page: 1 1 - 3 of 3

Time Property								
Alias	Box...	Current Utc Offset	Leap59	Leap61	Time Traceable	Frequency Traceable	Time Source	PtpTime Scale
ptp1	1	36	0	0	0	0	Internal Oscillator	1
ptp2	2	36	0	0	0	0	Internal Oscillator	1
ptp3	3	36	0	0	0	0	Internal Oscillator	1

Figure 334: PTP Clock Details

Following table lists the PTP clock attributes and their descriptions:

PTP Clock Attribute	Description
Local PTP Clock	
Alias	The unique name for the PTP template that you configured globally for the device.
Box ID	The box identifier of the device.
Clock Identity	The clock identity of the device. It is a 64-bit global identifier (EUI-64) as defined by the IEEE 1588 standard.
Ptp Time (sec)	The actual PTP time with nanosecond resolution.
Mean Path Delay	The forward and reverse path delay in steady state is used to calculate the mean path delay.
Steps Removed	The number of boundary clocks between the local clock and the foreign master clock.
Domain	The network within which PTP operates, that is all the clocks within a domain are in synchronization.
Offset From Master	The time difference between the master and the slave, measured in nanoseconds. Once this is computed, the slave will readjust its clock to align with the master.
Priority2	The priority value used to determine the grandmaster in a network. For example, if there are two clocks in a network that match the default criteria, the clock that has the lower priority value will be selected as the grandmaster.
Mode	The clock modes. The values are: <ul style="list-style-type: none"> • Ordinary clock—A clock that has only one PTP-enabled port and maintains the timescale used in the domain. It can serve either as a master or a slave. • Boundary clock—A clock that has multiple PTP-enabled ports and maintains the timescale used in the domain. The ports can serve either as a master or a slave.
Port Ptp Count	Number of ports on which the PTP template is enabled. Gigamon supports a maximum of 10 boundary clock ports in a device.
Clock Quality Accuracy	The clock quality announced by the master. This value is used to select the best clock source between two PTP master clocks and switches dynamically to the clock that has greater accuracy.
Step Type	The timestamp mode that is used by PTP. The values is:

PTP Clock Attribute	Description
	<ul style="list-style-type: none"> One-step mode—PTP master does not send any follow up message because the synchronization message itself contains the transmit timestamp as well as the correction filed to obtain the precise transmit timestamp.
Local Clock Time	The actual local clock time on the device.
Local Priority	The priority value used to determine the PTP master when the BMC algorithm chooses more than one clock as the master. This value overrides the default criteria for the BMC selection. The clock with the lower priority value will be selected.
Clock Quality Class	Attribute of an ordinary or boundary clock that denotes the traceability of the time or frequency distributed by the grandmaster clock.
Clock Quality Offset	The time difference in clock quality between the master and the slave, measured in nanoseconds.
Parent Clock State	
GM Clock Identity	The clock identity of the grandmaster. It is a 64-bit global identifier (EUI-64) as defined by the IEEE 1588 standard.
GM Priority1	The priority value of the grandmaster clock. Lower value takes precedence.
GM Priority2	The priority value of the grandmaster that is used when GM Priority1 value is the same for different masters in a network.
Observed Offset	The time difference that is observed between the master and the slave.
Clock Port ID	The port identifier assigned by the PTP clock.
Stats	Indicates whether the values of <code>parentDS.observedParentOffsetScaledLogVariance</code> and <code>parentDS.observedParentClockPhaseChangeRate</code> have been measured and are valid.
Observed Phase Change Rate	An estimate of the parent clock's phase change rate as measured by the slave clock.
GM Clock Quality Accuracy	The expected accuracy of the grandmaster clock.
GM Clock Quality Class	The grandmaster clock's traceability of the distributed time or frequency.
GM Clock Quality Offset	The time difference in clock quality between the grandmaster and

PTP Clock Attribute	Description
	the slave, measured in nanoseconds.
Time Property	
Current UTC Offset	The time difference between International Atomic Time (TAI) and Universal Coordinated Time (UTC).
Leap59	The last minute of the current UTC day has only 59 seconds (instead of the 60 SI seconds).
Leap61	The last minute of the current UTC day has only 61 seconds (instead of the 60 SI seconds).
Time Traceable	The timescale and the UTC offset are traceable to a primary reference.
Frequency Traceable	The frequency that determines the timescale is traceable to a primary reference.
Time Source	The time source that is external to PTP. The time source is traceable to the international standards laboratories maintaining clocks that form the basis for the TAI and UTC timescales. Examples of these are GPS, NTP, and National Institute of Standards and Technology (NIST) timeservers.
Ptp Time Scale	The time scale to use when advertising time for PTP.

Viewing the PTP Foreign Master Details

Use the PTP Foreign Master page to view the PTP details of the master that is learned by a port. The foreign master record will be available only when a port is in the slave state. To view this page, go to **Settings > Date and Time > PTP Foreign Master**.

In [Figure 334: PTP Clock Details](#), you can see that there is no foreign master record for the port 1/1/c13 because the port is in the master state. Whereas, the foreign master record appears for the port 1/1/c29, which is in the slave state.

Total Ports: 4 Filtered By: None														
Expand All Collapse All														
Port Id	Port Alias	Box Id	Best Mas...	Port Identity	Grandmaster Priority2	Announce Msg Co...	Steps Removed	Grandmaster Clock Ide...	Port Module Nu...	Port Num...	PTP Prot...	Clo...	Gra...	Last Sync
1/1/c13		1	0											
▼ 1/1/c29		1	0											
				00:1d:ac:00:...	100	4	0	00:1d:ac:00:00:66:1a:70	0	92	IPv4 Ethe...	10.1...	128	29
2/1/c29		2	0											
▼ 3/1/c13		3	0											
				00:1d:ac:00:...	100	4	1	00:1d:ac:00:00:66:1a:70	0	25	IPv4 Ethe...	10.1...	128	1411457

Figure 335: PTP Foreign Master Details

Following table lists the PTP foreign master attributes and their descriptions:

PTP Foreign Master Attribute	Description
Port ID / Port Alias	The port identifier.
Box ID	The box identifier of the device.
Best Master	The best master clock for the device.
Port Identity	The clock identity of the foreign master that the port has learned.
Grandmaster Priority2	The priority value of the grandmaster that is used when Grandmaster Priority1 value is the same for different masters in a network.
Announce Msg Count	The total number of announce messages that were sent and received by the port.
Steps Removed	The number of boundary clocks between the local clock and the foreign master clock.
Grandmaster Clock Identity	The clock identity of the grandmaster. It is a 64-bit global identifier (EUI-64) as defined by the IEEE standard.
Port Module Number	The module number of the physical port.
Port Number	The physical port identifier.
PTP Protocol	The protocol used by the PTP is IPv4 Ethernet.
Clock Address	The IP address that is derived based on the clock ID.
Grandmaster Priority1	The priority value of the grandmaster clock. Lower value takes precedence.
Last Sync	The time when the last synchronization message was sent by the foreign master to the slave.
Last Follow Up	The time when the last follow-up message was sent by the slave to the foreign master.
Last Delay Response	The time when the last delay response was sent by the foreign master to the slave.
Mtsd Scaled Avar	MTSD-scaled Allan variance (nsec-sq).
Quality Class	The traceability of the time or frequency distributed by the foreign master clock.
Quality Offset	The log variance field of the announce message.
Quality Accuracy	The clock accuracy indicates the expected accuracy of the foreign master clock.

Viewing PTP Statistics

Use the PTP Statistics page to view the PTP statistical data such as the received, transmitted, and discarded packets, queue overflow, and so on for a port on a device. You can also verify if there are any errors in the PTP configuration. You can choose to filter the data by box ID and PTP alias.

To view this page, go to **Settings > Date and Time > PTP Statistics**. [Figure 336: PTP Statistics](#) shows the PTP statistics details.

<input type="checkbox"/>	Alias	Box Id	Discarded Packets	Rx Packets	Tx Packets	Queue Overflow Rx...	Rcpu Encap Rx Pac...	Ipv4 Ptp Rx Packets	Ipv6 Ptp Rx Packets	L2 Ptp Rx Packets	Udp Ptp Rx Packets
<input type="checkbox"/>	▼ ptp1	1	0	39412	123218	0	39412	39412	0	0	39412
<input type="checkbox"/>	1/1/c13	1	0	39426	40465						
<input type="checkbox"/>	> ptp2	2	0	27573	95729	0	27573	27573	0	0	27573
<input type="checkbox"/>	▼ ptp3	3	0	83862	75587	0	83862	83862	0	0	83862
<input type="checkbox"/>	3/1/c13	3	0	42424	41059						

Figure 336: PTP Statistics

Following table lists the PTP statistical attributes and their descriptions:

PTP Statistical Attribute	Description
Alias	The unique name for the PTP template that you configured globally for the device.
Box ID	The box identifier for the device.
Discarded Packets	The number of packets that were discarded by the port because of mismatch in the domain or VLAN.
Rx Packets	The number of packets that were received by the port.
Tx Packets	The number of packets that were transmitted by the port.
Queue Overflow Rx Packets	The queue overflow of the received packets.
Rcpu Encap Rx Packets	The RCPU-encapsulated packets received.
Ipv4 Ptp Rx Packets	The IPv4 PTP packets received.
Ipv6 Ptp Rx Packets	The IPv6 PTP packets received.
L2 Ptp Rx Packets	The L2 PTP packets received.
Udp Ptp Rx Packets	The UDP PTP packets received.

PTP and Timestamp—Rules and Notes

Keep in mind the following rules and notes when working with PTP and timestamp:

- PTP and timestamp is supported only on GigaVUE-TA200 device.
- Timestamp is not supported on circuit, stack, and hybrid ports.
- PTP supports only one-step synchronization.
- PTP requires a dedicated front-end port and can be enabled only on network ports. You cannot use the PTP-enabled port for any other GigaVUE-OS features.
- Ensure that the VLAN ID and the domain for the PTP are the same for both the nodes between which the session needs to be established. However, the VLAN IDs of the ports within a node must be unique.
- All port-related PTP intervals such as, announce, sync, and delay request must be the same between nodes.
- Transparent clocks and peer-to-peer delay request mechanism are not supported.
- Priority 1 configurations are not supported based on the ITU-T G.8275.1 standard.
- Once you have configured PTP and timestamps are being captured, it is recommended that you do not change the PTP configurations so that the timestamps are accurate.

Fabric Maps

Fabric maps simplify how you create flow mapping across multiple clusters. Using GigaVUE-FM, you can create and manage flow maps. You can provide cross-cluster flow mapping parameters by creating a fabric map. GigaVUE-FM then allocates the required circuit ID resources, along with generating and deploying cluster specific maps and fabric paths (refer [About Circuit-ID Tunnels](#)). Fabric paths can be defined as the link between the devices through which the traffic flows. With a successfully deployed fabric map, you can save time and effort because you no longer need to replicate rules at each hop on the network to manage cross-cluster traffic.

Supported Topologies

Fabric map support is available for the following topologies:

- [Multiple Access or Aggregation Clusters](#)
- [Multi-Cluster Mesh](#)
- [Multihop Fabric Map](#)
- [Affinity-Based Leaf-Spine Support](#)

Multiple Access or Aggregation Clusters

In this topology, a set of access switches is connected to network ports. This is the access cluster. The access cluster is then connected to a tool-hosting cluster using Ethernet interfaces. The tool-hosting cluster is connected to the tool ports or to GigaSMART operations (GSOP).

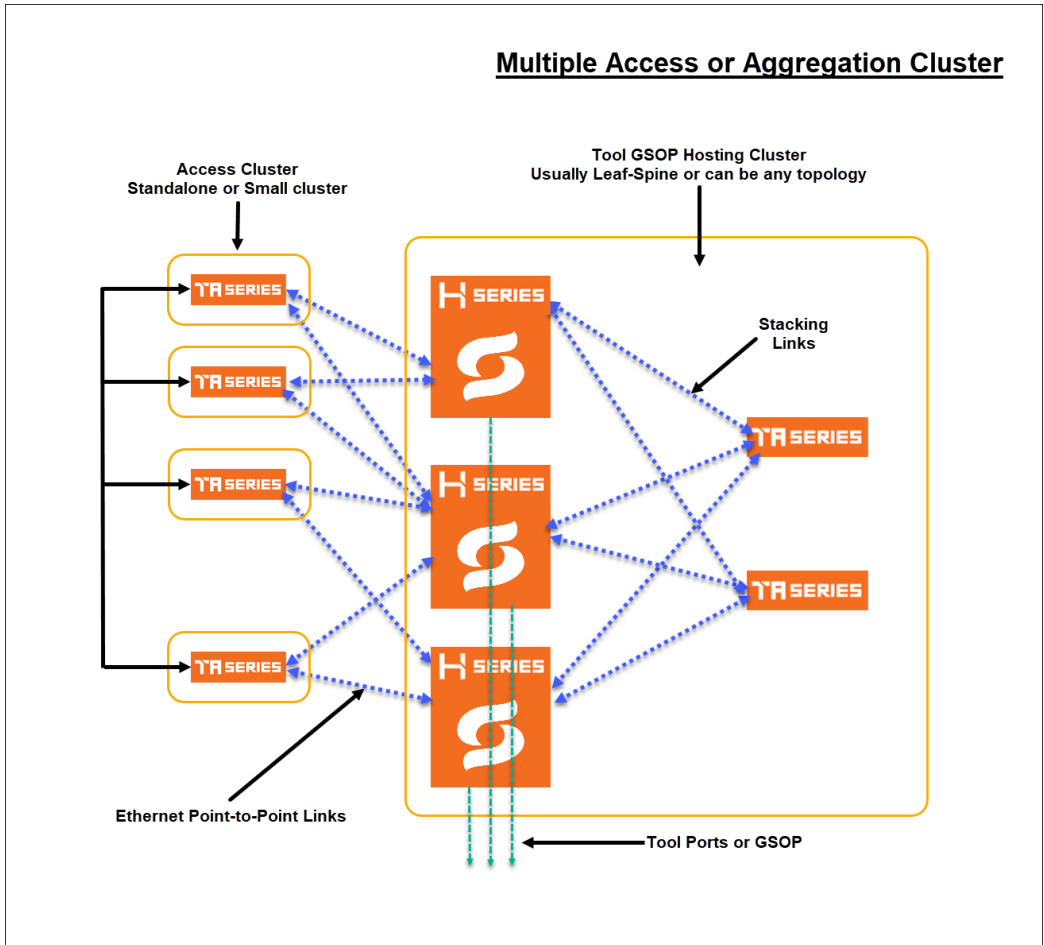


Figure 337: Multiple Access Clusters

The access nodes are connected to the tools cluster using point-to-point Ethernet links, which offer redundant connections to multiple nodes within the tool cluster.

This topology illustrates how ports can be created from any network port to any tool port as a single fabric-wide map.

Multi-Cluster Mesh

The following is an illustration of multi-cluster mesh topology. In this topology there are three clusters, (A, B and C) with each cluster containing network ports, tool ports and applications (GSOP).

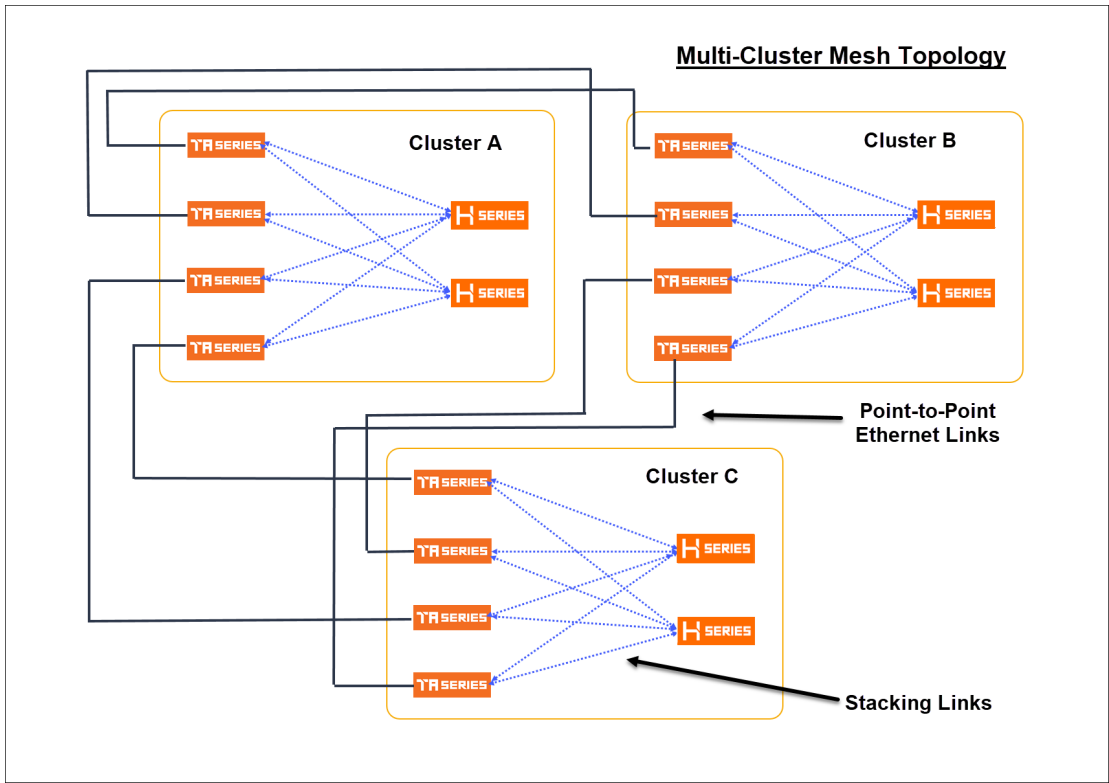


Figure 338: Multi-Cluster Mesh

Multihop Fabric Map

Fabric maps support multihop topology in which the maps can be created across clusters and nodes that are not connected directly. Traffic passes through the intermediate nodes to the destination.

In the following topology, fabric map is created between GigaVUE-TA A node and GigaVUE-HC-B node. But, traffic passes through the intermediate GigaVUE-TA node to reach the GigaVUE-HC-B node.

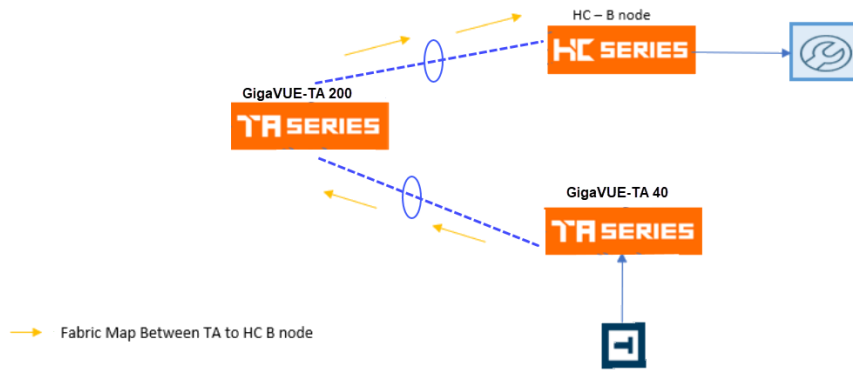


Figure 339: Multihop Topology

Fabric Maps Prerequisites

To deploy flow maps, you must complete the following prerequisites:

- Designate inter-cluster connection ports as circuit ports. Refer to [Configure Ports](#).
- Configure a regular circuit GigaStream with the required circuit ports. Refer to [Configure Regular GigaStream](#).
- Create links between clusters. Refer to [Create Links between Clusters](#).

Using GigaVUE-FM, you can create connections between devices using manual topology links, or you can have the devices discovered through the Gigamon Discovery (GDP). After you create physical links between devices, the device configuration needs to be added into GigaVUE-FM, so that flow maps can use it. Once the circuit and GigaStream ports are created and connected to the devices, you can start creating flow maps. See [Enable Gigamon Discovery on Chassis](#) for more information on GDP.

Notes on Circuit Ports and Circuit GigaStream in Fabric Maps

As mentioned in the pre-requisites section, Circuit ports and Circuit GigaStreams are required for creating flow maps. Refer to the following notes:

- You cannot specify the Circuit Ports and Circuit GigaStreams that are to be used in a fabric map. You can only define the Circuit Ports and Circuit GigaStreams.
- Circuit Ports and the Circuit GigaStream for the fabric path are selected as follows:
 - Circuit GigaStreams at the first clusters are selected randomly for efficient load balancing.

- For hop beyond second hops, previously used circuit Gigastreams may be selected if 'Resource Sharing' is set to enabled mode. This allows to reuse the circuit tunnels previously created. Refer to [Share Circuit ID Resource](#).

Consider the following leaf-spine topology. Fabric map is created between the two leaf nodes and the spine node. The second circuit GigaStream in the leaf node may be used when the circuit ports are of different speeds.

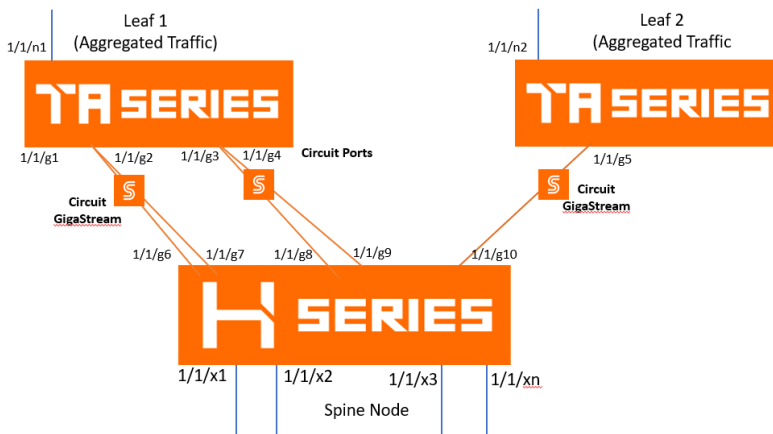


Figure 340: Circuit GigaStreams in Fabric Maps

Create Links between Clusters

You can either connect the devices manually or you can have them automatically discovered by Gigamon Discovery Protocol (GDP). If a user's ports are already physically connected, then the link between those ports will be displayed if GDP is enabled at both ends and the physical links are up. GDP must be enabled in both the source and destination ports to have the devices displayed in the topology map.

- [Create Manual Links](#)
- [Create Gigamon Discovery Protocol \(GDP\) Based Links](#)

Create Manual Links

To create links manually, do the following.

1. Go to **Physical > Topology**.
2. Select **Add Link(s)** option from the **Add** tab drop-down menu on the Topology menu bar.
3. Select the **Source** device and the circuit port which you already created.
4. Select the **Destination** device and the circuit port which you already created.
5. Click **Submit** to connect the devices.

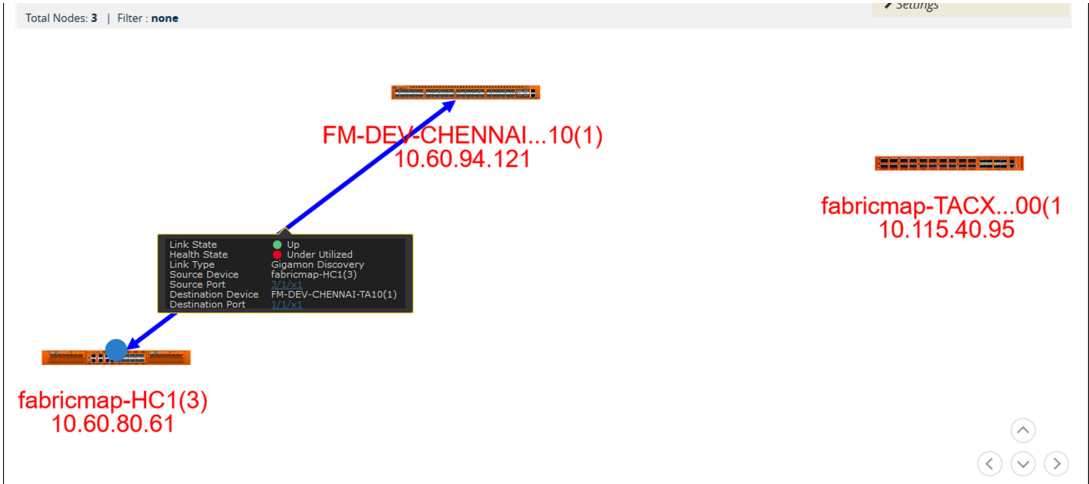


Figure 341: Connecting Devices

6. Click the Topology link from left-navigation menu to view the connection.

After you have successfully connected your devices, the topology map is displayed with the connections. If you click on the connected devices link, you can view the connection details of the ports you created.

Create Gigamon Discovery Protocol (GDP) Based Links

To create Gigamon Discovery Protocol (GDP) based links:

1. Go to **Physical > Physical Nodes**.
2. Select the node (Source or Destination).
3. Select **Ports**. On the Ports screen, place a check mark next to the circuit port.
4. Click **Edit** from the top menu bar. The Port screen is displayed for the device you selected.

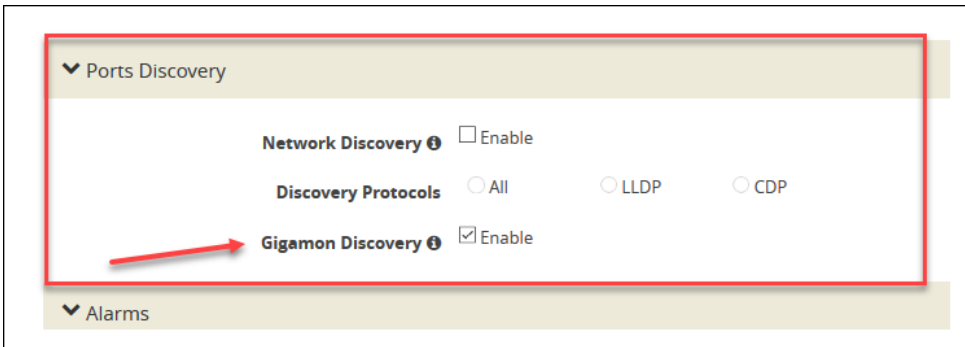


Figure 342: Gigamon Discovery Protocol

5. Click **OK** to submit configuration. You must then enable GDP on the device chassis as follows:

- a. Select > **Chassis**. The chassis screen is displayed showing the Gigamon hardware.

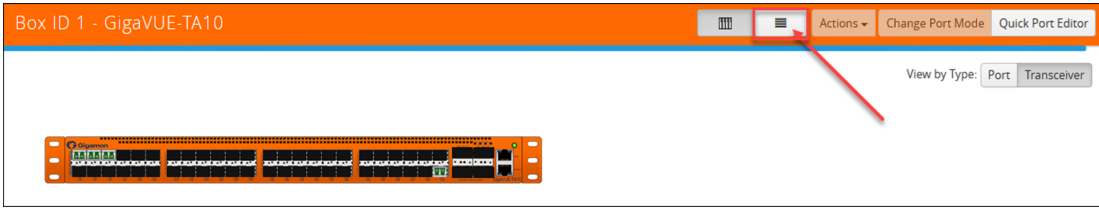


Figure 343: Chassis Screen

- b. Click the **List View** icon located at the top of the page. Details about the chassis is displayed in a list view format.
- c. Select **Enable Gigamon Discovery** from the **Actions** menu at the top of the screen.

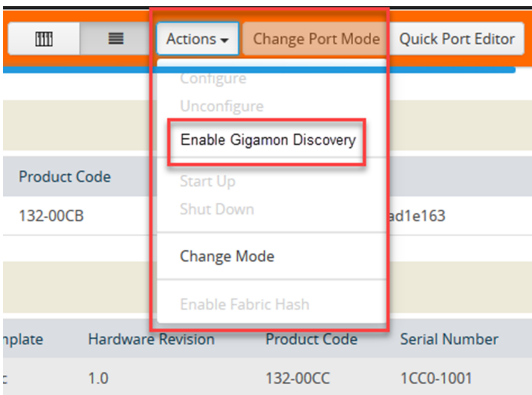


Figure 344: Enabling Gigamon Discovery

NOTE: This action must be done for both the source and the destination devices.

This completes the prerequisites steps for creation of flow maps. Refer to section [Create Fabric Maps](#) for details on creating flow maps.

Create Fabric Maps

To create Fabric Maps:

1. Click **Physical > Fabric Maps**.

The following table describes the parameters displayed in the fabric map list view.

Field	Description
Alias	Alias name of the fabric map

Field	Description
Source	Number of source ports associated with fabric map
Destination	Number of destination ports associated with fabric map
Rules	Rules for fabric map
GigaSMART Alias	Alias name of the GigaSMART operation
Type	Port type
Enabled	Indicates if fabric map is enabled – Yes/No
Status	Health status of the fabric map

2. Click **Create**.The create map screen is displayed.

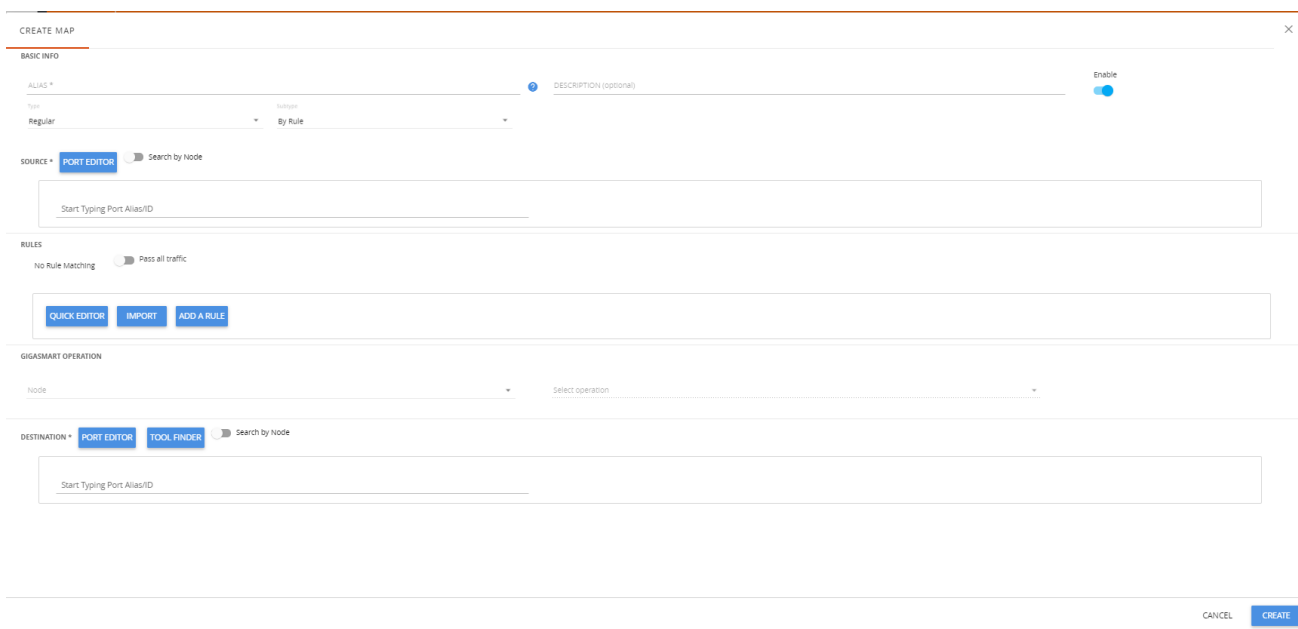


Figure 345: Create Fabric Maps

3. Enter map parameters as described in the following table:

Field	Description
Basic Info	
Alias	Alias name of the fabric map
Description	Fabric map description
Enable	Toggle option that lets you toggle between:

Field	Description
	<ul style="list-style-type: none"> • Enable: Traffic passes through the fabric map that is created. • Disable: Traffic is temporarily prevented from passing through flow maps if 'Disable' is selected.
Type	Map type. Options are: <ul style="list-style-type: none"> • Regular • First level • Second level
Subtype	Map subtype. Options are: <ul style="list-style-type: none"> • By Rule • Pass All • Collector
Source	Source port. Use the toggle bar to toggle between the following two options <ul style="list-style-type: none"> • Enter the port alias/port id, or • Specify the source node and source ports. Use the +/- icon to add new nodes or remove source ports.
Rules	Enable Non-Matching Rules for map type 'Regular'. Use the toggle bar to either Pass all traffic or not. The following options are available: <ul style="list-style-type: none"> • Quick Editor: To select the port number or numbers to add for a pass or drop rule or both. • Import: To import a map template • Add a Rule: To add a description and select one or more conditions. <div data-bbox="472 1524 1261 1612" style="border: 1px solid #ccc; padding: 5px; margin-top: 10px;"> <p>NOTE: Using this option, you can only add rules one at a time. Click the +/- icon to add or delete rules and conditions.</p> </div>
GigaSMART Operation	Select a GigaSMART OPERATION node and operation.
Destination	Destination port. You can either: <ul style="list-style-type: none"> • Enter the port alias/port id, or

Field	Description
	<ul style="list-style-type: none"> Specify the destination node and destination ports. Use the +/- icon to add new nodes or remove destination ports. <p>Use the toggle bar to toggle between these two options. Click the Tool Finder option to search for the available destination ports.</p> <div style="border: 1px solid #ccc; padding: 5px;"> <p>NOTE: Starting in software version 5.7, you can also select the Null Port option for the second level maps if you do not want to send the traffic to any physical port. Refer to the "Create Application Filtering Intelligence by Selecting Applications from Dashboard" section for the use of null port in application intelligence solution.</p> </div>

- After you enter all the fabric map parameters, click **Create**. The new fabric map is added to the list view.

Edit and Delete Fabric Maps

You can edit and delete the flow maps . Refer to the following section for details:

- [Edit Fabric Maps](#)
- [Delete Fabric Maps](#)

Edit Fabric Maps

To edit fabric Maps:

- Select **Physical > Fabric Maps**.
- Select a fabric map. Each fabric map has a summary page.
 - The top half of the summary page displays the fabric map component interactions and traffic flow.
 - The bottom half of the screen displays the following tabs:
 - Summary: Summary of ports and maps
 - Rules: List of rules associated with the fabric map
 - Statistics: Fabric map statistics.
- Click on any component in the fabric map to display more details about the component.

Edit Fabric Map Component

- Click the **Fabric Map component** icon. The fabric map component summary screen appears.
- Click the option menu and select **edit**.

3. Edit fabric map parameters.
4. Click **Save** to update the fabric map components.

Delete Fabric Maps

1. Select the fabric map you want to delete from the flow maps summary page.
2. Click the **Trash Can** icon. Confirm delete notification and click **OK**.

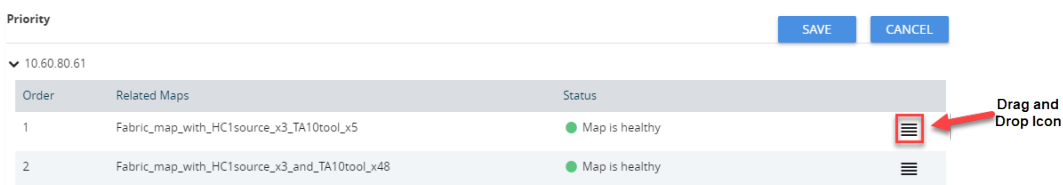
After the fabric map is deleted you will see an acknowledgment on the screen. Refresh the fabric map summary page to confirm the fabric map is deleted.

Prioritize Fabric Maps

You can prioritize the traffic flowing through the flow maps. The priority of the fabric map is implemented through cluster level map priorities and can be adjusted at the cluster level.

To prioritize the traffic flow through flow maps:

1. Select **Physical > Fabric Maps**.
2. Select a fabric map and click **View Details** either from the **Task** drop-down menu or from the fabric map selected.
3. Scroll down to view the current priority setting of the flow maps.
4. Click **Change FabricMap Priority**.
5. Use the drag and drop icon to change the order of priority.



Order	Related Maps	Status
1	Fabric_map_with_HC1source_x3_TA10tool_x5	● Map is healthy
2	Fabric_map_with_HC1source_x3_and_TA10tool_x48	● Map is healthy

6. Click **Save** to save the changed priority.

NOTE: The priority list includes both flow maps and cluster maps, which are grouped and prioritized based on the cluster ID.

Share Circuit ID Resource

You can share the circuit id resources for the flow maps created for the same destination. To do this:

1. Select the **Settings** icon on the top navigation bar to open the Share Resources dialog.
2. Enter the **Circuit Id Range** (Min and Max values). Use the +/- icon to increment/decrement the circuit id range.
3. Click **Save** to save the settings.

The Share Resources option is **enabled** by default. Use the toggle bar to disable this option.

Fabric Maps Statistics

GigaVUE-FM provides the ability to view detailed information about flow maps configured between the devices including packets received and transmitted by the following ports:

- Network ports
- Tool ports
- Hybrid ports
- Circuit ports
- Inline-network ports
- Inline-tool ports
- GigaSMART engine ports

Display Fabric Map Statistics

Using the fabric map statistics page, you can view the statistics associated with the port types. If there are packet drops in the ports, you can use the statistics page to investigate the cause of the packet drops. Fabric map statistical data is generated from the rules you specify when you create a fabric map.

Display Fabric Map Details

To display the fabric map details:

1. Select **Physical > Fabric Maps**.
2. Click on a **Fabric Map** from the main page. The fabric map list view is displayed.
3. Click the **View Statistics** from the options menu. The statistics screen is displayed. Using this screen, you can view fabric map traffic data rates intervals.

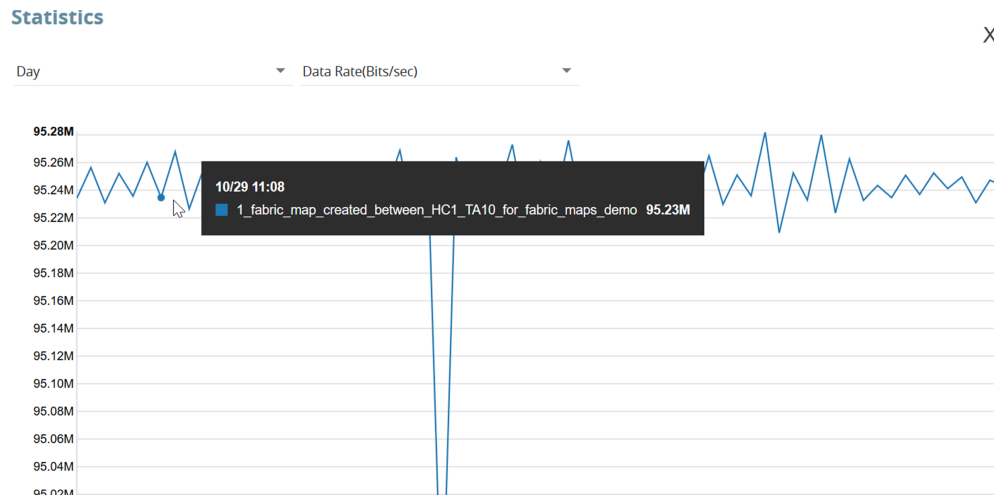


Figure 346: Fabric Maps Statistics

NOTE: Statistics and data rates can be displayed per hour, day, week, or month.

4. Click the current statistics label, (Hour, Day, Week or Month), to display the options menu where you can select a different statistics view.

Filter Fabric Maps List View

Using the filter function, you can search and narrow down the flow maps you want to be displayed on the fabric map list view page.

1. To use the filtering functionality, click the **Filter** icon.

The Filter quick view dialog is displayed.

2. Enter the parameters to specify the data you want to display:

Fabric map filter parameter options:

Criteria	Description
Alias	Alias name of the Fabric Map
Source	Source port(s) of the Fabric Map
Destination	Destination port(s) of the Fabric Map
Status	Displays health of the fabric map. Options are: Healthy, Unhealthy, and Warning

Criteria	Description
Show Auto Generated Fabric Maps	Toggle bar that allows you to show/hide the auto-generated flow maps when flow maps page is loaded.

Troubleshooting

There may be situations when fabric fails because of a configuration error or you need to investigate an unhealthy GigaStream or port associated with fabric map. Fabric map maintains the configuration status and health state.

The configuration statuses are SUCCESS, FAILED, and PARTIAL_SUCCESS. You can investigate issues related to flow maps and once issues are corrected, you can run resubmit to push changes. Health state is consolidated from generated components healthStates.

Fabric Maps health states consist of the cluster level maps, (ports), and circuit tunnels (ports and links). After configuration and health state issues are corrected you can sync the Fabric configStatus and healthStates.

To use the troubleshooting feature:

1. Select **Physical > Fabric Maps**.
2. Select a **Fabric Map** to troubleshoot.
3. Select **View Details** from the **Task** drop-down menu.

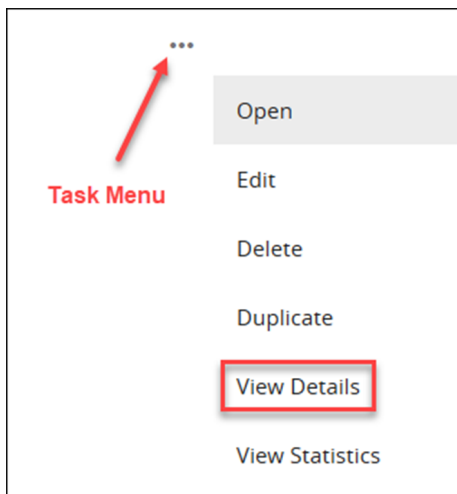


Figure 347: View Details.

The Details screen displays fabric map component details.

4. Click the **More Info** link to display the fabric map details.
5. Click the **Troubleshoot** link to display troubleshooting options.

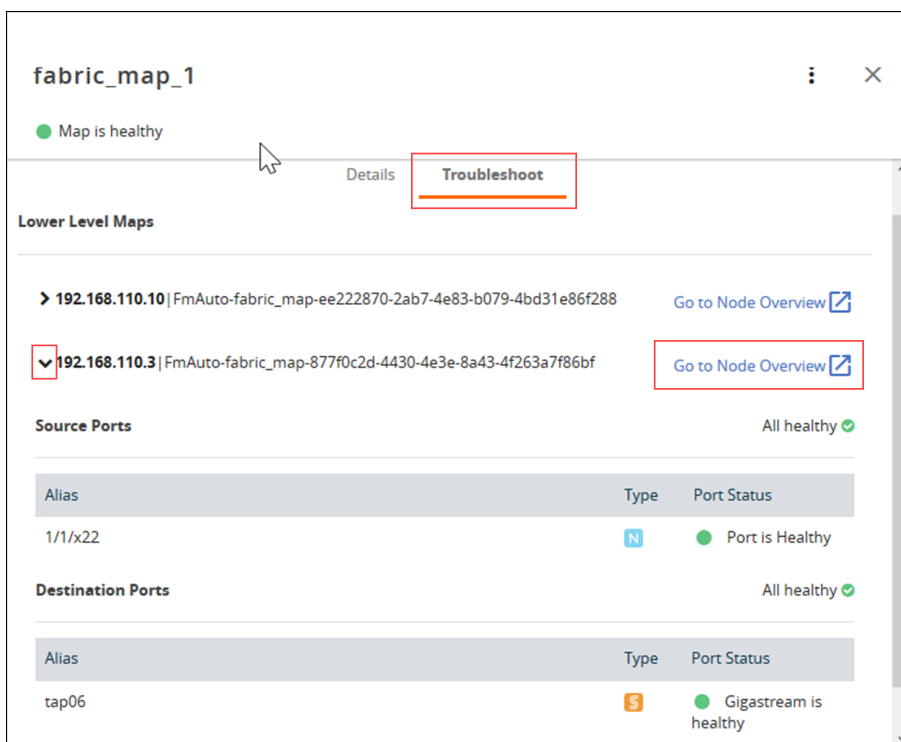


Figure 348: Troubleshooting

6. Click the > **arrow** next to the fabric map to display the map details. Use this screen to investigate configuration issues related to your fabric map.

Fabric Map Configuration Status

The following table helps to troubleshoot a failed or partially successful fabric map configuration.

Configuration Status	Definition	Suggested Action
SUCCESS	Fabric map was accepted at GigaVUE-FM level and traffic flow deployed correctly.	<ul style="list-style-type: none"> • No action required
FAILED	Fabric map was not configured correctly and not accepted or deployed at GigaVUE-FM level.	<ul style="list-style-type: none"> • Go to the topology page and ensure there is a link between the cluster. • Make sure the circuit GigaStreams

Configuration Status	Definition	Suggested Action
		<p>are successfully created.</p> <ul style="list-style-type: none"> If the clusters are no longer connected, connect the clusters and reapply the configuration. If the circuit GigaStreams are configured correctly, make the necessary changes and reapply the configuration.
PENDING	<ul style="list-style-type: none"> This means no fabric path exists between 2 nodes. <p>or</p> <ul style="list-style-type: none"> There is a failed operation on the device and further deployment of cluster level maps are not allowed in that device. 	<ul style="list-style-type: none"> Create a fabric path and reapply fabric map.
PARTIAL_SUCCESS	This means a portion of the fabric map was accepted at GigaVUE-FM level, but devices cannot provision the generated components.	<ul style="list-style-type: none"> See How to Troubleshoot Partial Success Errors for more details.

Fabric Map Health State

The following table helps to troubleshoot the health state of your fabric map.

Health State	Definition	Suggested Action
Healthy	All fabric map components (nodes, ports, GigaStreams) are all healthy.	<ul style="list-style-type: none"> • No action required.
Unhealthy	An unhealthy state means there could be a port that is down or packets dropped.	<ul style="list-style-type: none"> • Make sure no ports are down and no packets dropped. • Correct any configuration connection issues, and re-sync the fabric map.

How to Troubleshoot Partial Success Errors

If your fabric map displays a red status light on the list view page, this means a portion of the fabric map was accepted at GigaVUE-FM level, but devices cannot provision the generated components.

The error message associated with fabric map appears when you hover over the fabric map status column. You can use the error message to help you troubleshoot and identify the components that are in conflict or mis-configured.

Example 1:

In the following example, the status error message indicates that the ports are mis-configured. You can use the following workflow as a best practice for investigating and correcting map configuration problems.

1. Hover over the fabric map status column displaying a red status light to view the error message. The error message provides information on the possible issues present with fabric map components.

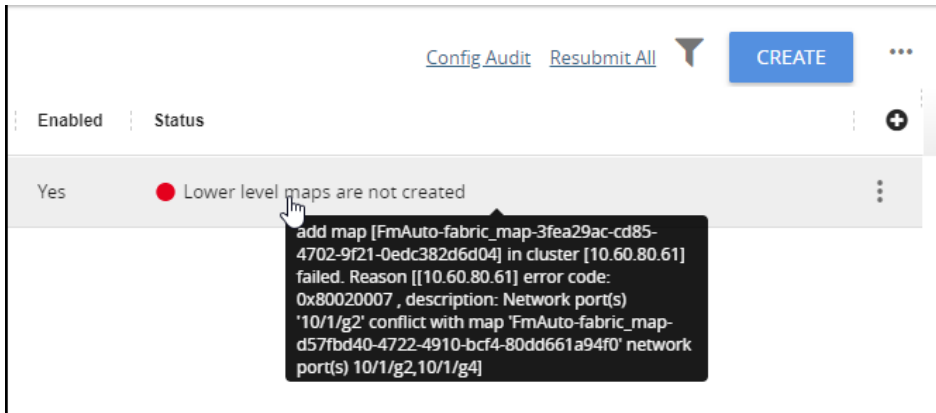


Figure 349: Troubleshooting

This error indicates that the input network ports overlapped with the existing map, and therefore it is required to correct this issue and remove the overlapping ports. Use this screen to investigate the exact ports causing the problem.

2. Click **View Details** from the options menu. The fabric map detail screen is displayed.

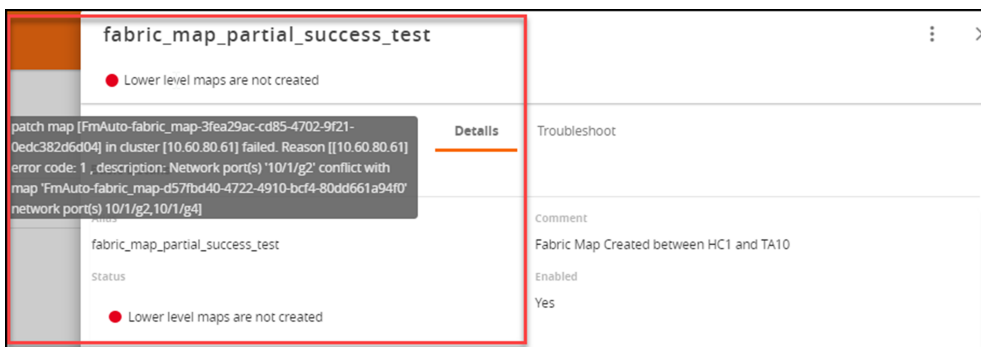


Figure 350: Fabric Maps Details

3. Click the **Troubleshooting** link. Scroll down the screen to investigate the Source and Destination ports configurations.

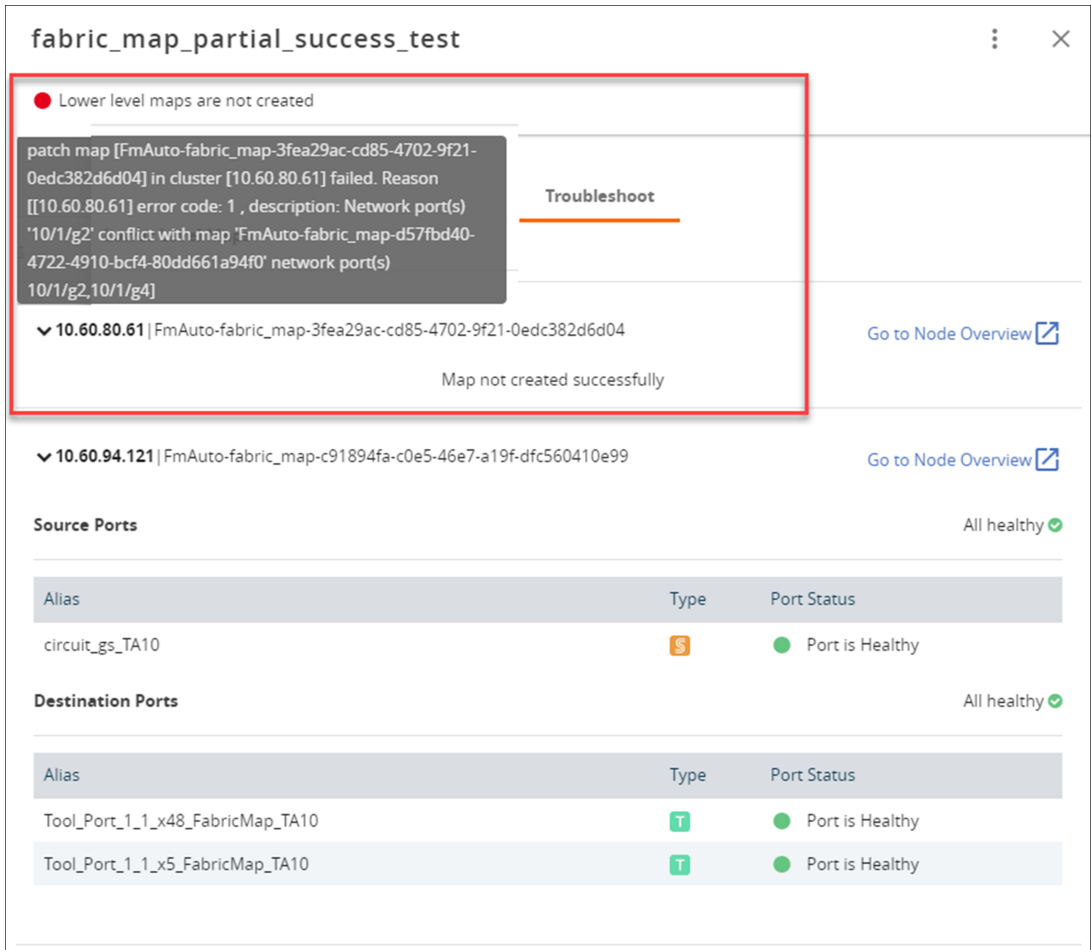


Figure 351:

The network ports that you tried to add to your fabric map were not available and contributed to the error in the fabric map configuration. Next, you need to edit the network ports.

4. Click **Edit** from the options menu to edit the fabric map.

Figure 352: Editing Fabric Maps

5. Select the **Source Ports** component.

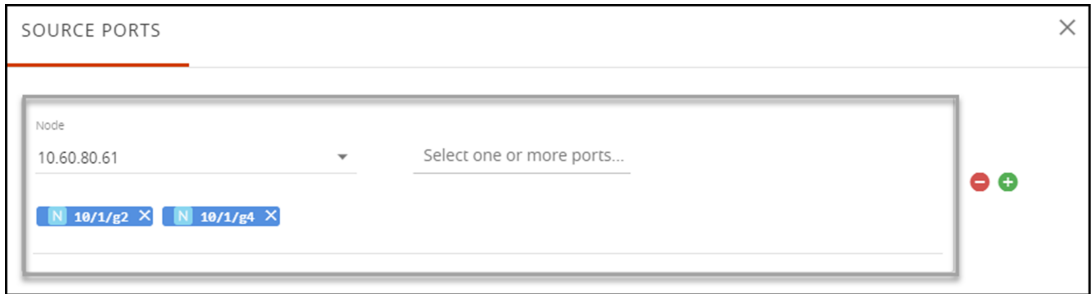


Figure 353: Source Port Component

6. The Source Ports screen appear.
7. Edit the source ports with correct information and save your configuration.

8. Click **Submit** on the **Edit Fabric Map** page.

After you have successfully updated the fabric map component causing the problem, the fabric map list view displays a healthy status symbol.

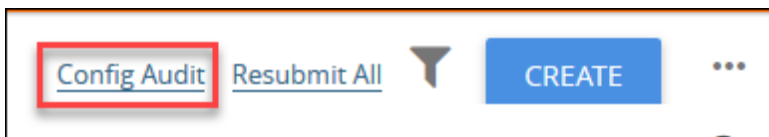
If a problem with the fabric map still exists, repeat the steps above to identify and track down the problem.

Config Audit

Use the Config Audit option to conduct an audit of your fabric map configuration. This process audits the configuration including the components of your fabric map. Config audit verifies that the fabric map configuration is active, the devices are connected, and traffic is flowing through the fabric map with no issues.

To start the configuration audit process:

1. Select **Physical > Fabric Maps**.
2. Click the **Config Audit** link at the top of the screen.



After the config audit is complete, a notification appears with the audit results.

If the config audit is not successful, check the fabric map configuration error message(s) for help in resolving issues.

Limitations of Fabric Maps

The following are the limitations of Fabric Maps:

- Circuit ports, circuit GigaStreams and manual topology links (or GDP must be enabled on circuit ports to discover the connected clusters) must be configured before creating fabric map.
- In first-level type fabric map, one vport is required for the destination. However, Fabric Maps can have multiple tool/hybrid ports from multiple cluster in the destinations in addition to the vport, but the map type remains as the first-level map type.

- In multi-hop scenarios, it is not recommended to create a single level fabric map with GSOP. You must create a vport associated with GSOP, and then create the first and second level maps with the vport to perform the GSOP operations.
- Fabric map configurations are saved in GigaVUE-FM and not in the individual devices. Therefore, if you change the GigaVUE-FM instance that manages the devices, then fabric map configurations cannot be rediscovered from the devices. In this scenario, the GigaVUE-FM configuration that has been saved and backed-up from the original GigaVUE-FM instance must be restored to the new GigaVUE-FM instance to continue.
- To avoid FAILED or PENDING state, or no traffic stats found during deployment of flow maps, you must ensure that the associated devices are connected to GigaVUE-FM and also inter-connected for traffic paths.

Starting in software version 5.5, flow maps support directly connected clusters. Refer [Supported Topologies](#).

GigaSMART® Operations

Use the **GigaSMART Operations** page to create GigaSMART® operations. GigaSMART operations consist of a name and a supported combination of the available GigaSMART applications that you have licensed.

- Refer to [How to Combine GigaSMART Operations](#) for details on supported combinations of GigaSMART operations.
- Refer to [Order of GigaSMART Operations](#) for information on the order in which GigaSMART components are applied in a single operation.

The details of each GigaSMART operation are described in the following sections, organized by solution type:

<p>Application Intelligence</p>	<p>These GigaSMART operations provide network and application visibility to increase the efficiency of security and analytic tools:</p> <ul style="list-style-type: none"> • Application Intelligence • Application Session Filtering 	
<p>Subscriber Intelligence</p>	<p>These GigaSMART operations provide network and subscriber visibility to increase the efficiency of network monitoring, security, and customer experience tools:</p> <ul style="list-style-type: none"> • GTP Correlation • Diameter S6a Correlation • SIP/RTP Correlation • FlowVUE 	
<p>Traffic Intelligence</p>	<p>These GigaSMART operations provide network visibility to increase the efficiency of network performance tools:</p> <ul style="list-style-type: none"> • Adaptive Packet Filtering • Advanced Load Balancing • De-Duplication • Flow Masking • Header Stripping 	<ul style="list-style-type: none"> • Masking • NetFlow Generation • Slicing • SSL/TLS Decryption • Tunneling

For additional information about working with GigaSMART operations, refer to:

- [About GigaSMART Applications](#) for devices that support GigaSMART.
- [Work with GigaSMART Operations](#) for rules, tips, and general guidance about working with GigaSMART Operations.
- [Create GigaSMART Operations – A Summary](#) to get started with GigaSMART.
- [GigaSMART Logs](#) to learn about GigaSMART application logs.

For information about the types of licenses available, how to add and activate GigaSMART licenses, refer to the *GigaVUE-OS and GigaVUE-FM Administration Guide*.

Application Intelligence

Designed to meet the needs of security operations teams, these GigaSMART operations provide complete network and application visibility to increase the efficiency of security and analytic tools.

Application Intelligence	
Application Intelligence	<ul style="list-style-type: none"> • Application Intelligence • Application Filtering Intelligence • Application Metadata Intelligence
Application Session Filtering	<ul style="list-style-type: none"> • GigaSMART Application Session Filtering (ASF) and Buffer ASF

Application Intelligence

This chapter describes about the Application Intelligence solution and its operations. Refer to the following sections for details:

- [About Application Intelligence](#)
- [How Application Intelligence Works](#)
- [Create an Application Intelligence Session](#)
- [View the Details of an Application Intelligence Session](#)
- [Create Application Filtering Intelligence](#)
- [View the Application Intelligence Dashboard](#)
- [About De-duplication](#)
- [Create Application Metadata Intelligence](#)
- [View the Health Status of a Solution](#)
-

Required License: Application Filtering Intelligence, and Application Metadata Intelligence. The Application Monitoring capability is included as part of any one of this license.

Licensing

- Application Filtering Intelligence — Application Filtering Intelligence with Application Monitoring capability.
- Application Metadata Intelligence — Application Metadata Intelligence with Application Monitoring capability.
- Netflow basic — License for collecting metadata of packet attributes, for example IPv4, IPv6 and Interfaces.

NOTE: These licenses are valid for a year. After the expiration date, the system does not allow you to add new configuration or make any configuration updates but allows traffic flow for two weeks.

The following table provides details about the features available with the license:

License	Monitoring	Application Filtering Intelligence	Application Metadata Intelligence
Application Filtering Intelligence	✓	✓	✗
Application Metadata Intelligence	✓	Default Filtering Features available. ¹	✓
Adaptive Packet Filtering + Application Metadata Intelligence	✓	Default Filtering Features available. ²	✓
Application Filtering Intelligence + Application Metadata Intelligence	✓	✓	✓

¹By default, pass-all map is created in Application Filtering Intelligence session with null port. You can also define the physical port, if required.

²By default, pass-all map is created in Application Filtering Intelligence session with null port. You can also define the GigaSMART rules, if required.

About Application Intelligence

GigaVUE-FM Application Intelligence provides a comprehensive solution that:

- identifies the applications contributing to the network traffic.
- isolates preferred application-specific traffic and directs it to the appropriate tools.
- exports relevant application metadata for further analytics and analysis.

Application Intelligence provides the following capabilities:

- **Application Monitoring** - Identifies and monitors all applications contributing to the network traffic, and reports on the total applications and the total bandwidth they consume over a select period. Able to identify more than 3,200 applications. It displays the traffic statistics in bytes, packet and flows.
- **Application Filtering Intelligence** - Enables traffic filtering by layer 7 applications, which means you can filter out high-volume, low-risk traffic from reaching the tools and distribute high-risk network traffic of interest to the right tool at the right time.
- **Application Metadata Intelligence** - Supports exporting over 5000 attributes of metadata that provide relevant usage context on over 3,200 applications, thus enabling you to rapidly identify indicators of compromise (IoC) for security analytics and forensics tools.

How Application Intelligence Works

Figure 354: Application Intelligence Solution illustrates how the Application Intelligence solution works.

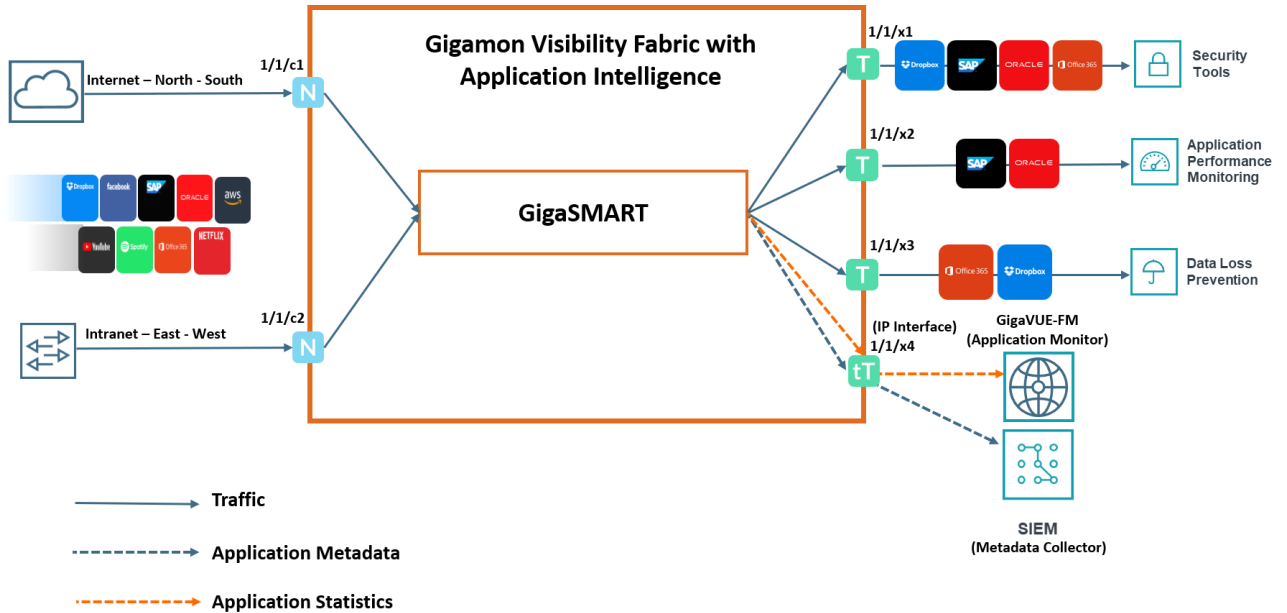


Figure 354: Application Intelligence Solution

The Gigamon device that is configured with the Application Intelligence capability receives the traffic through the network ports. Application Monitoring forwards the network traffic to the GigaSMART engine that exports applications related information to GigaVUE-FM, which renders the information on the Application Intelligence Dashboard. Based on the pass or drop rules configured in the maps, Application Filtering Intelligence lets relevant applications be guided to the tools. In this example, you can see that except some of the audio or video streaming applications such as Spotify®, YouTube, and Netflix, other applications are filtered out and dropped, and sent to the security tool. This is because the audio or video streaming applications are high-volume, low-risk traffic. The threat detection tool need not inspect such traffic. Hence, these applications are dropped based on the configured drop rules.

Application Metadata Intelligence allows you to export metadata from applications that are detected in the network traffic. The records can be exported to a collector either in IPFIX or CEF format through the IP interface or the management interface. You can also use the application metadata attributes for purposes other than security, such as to determine the network or application health, to track the long-lived sessions seen in the network, and so on.

Application Intelligence—Rules and Notes

Keep in mind the following rules and notes when working with the Application Intelligence solution:

- The Application Intelligence solution is supported on all the GigaSMART Modules of GigaVUE HC Series devices.
- Whenever you perform a backup and restore operation, you must create a backup of both the device and GigaVUE-FM and then restore the backed-up data on both as well.
- The best results for Application Metadata Intelligence can be obtained only if the traffic is bi-directional.

Create an Application Intelligence Session

Application Monitoring gathers the application statistics, and sends this information to GigaVUE-FM, which acts as an application monitor. The monitoring reports are sent to GigaVUE-FM through the destination port 2056. The application statistics appear as an array of monitoring reports that provide application-usage data in an easy-to-read graphical interface. This provides you with greater insight and control over how your network is being used and what applications are utilizing the most resources. To perform Application Monitoring, you must create the required application intelligence sessions for a device.

To create an Application Intelligence Session:

1. Go to **Physical > Physical Nodes**.

2. Click the Cluster ID of the node for which you want to create the Application Intelligence Session.
3. From the navigation pane, click **App Intelligence**.
4. Click **Create New**. The **Create Application Intelligence Session** page appears.

NOTE: If the Create button is disabled, check whether a valid license for Application Metadata Intelligence or Application Filtering Intelligence is available.

5. In the Basic Info section, enter the name and description for the session.
6. In the **Configurations** section, complete the following:
 - a. Select an export interval during which you want the Application Intelligence session to generate the reports for application monitoring. The valid range is 60–900 seconds.
 - b. Select a GigaSMART Group. You can also choose to create a new GigaSMART Group.
 - Provide a name in the **Alias** field.
 - Select a port or multiple ports from the **Port List**.
 - Click **Save**.

For more information about creating a new GigaSMART group, refer to the *Using GigaSMART Operations - Example*.

- c. Select an IP interface that is used to create a dedicated channel to communicate all application statistics to GigaVUE-FM. You can also choose to create a new IP interface.
7. If you are unable to view the required port in the **Port** field, perform these steps:
 - Click **Port Editor**. Select the **Type** as **Tool** from the drop-down list for the required **Port Id**. Select **OK**.

The selected Port appears in the list.

- Select the **Type** as:
 - IPv4 - to allow the traffic in IPv4 interface.
 - IPv6 - to allow the traffic in IPv6 interface.
- Provide the **IP Address**, **IP Mask**, **Gateway**, and **MTU**. Provide the IP address corresponding to the IP interface selected.
- Click **Save**.

For more information, refer to the *Create an IP Interface* section.


NOTE: By default, Management Interface is enabled. To export the data through IP interface, uncheck the Management Interface check box. You can view the **IP Interface** field only after you select a GigaSMART Group.

8. In the **Destination Settings**, enter the destination IP address. The version of IP address in the Destination field should be same as the version of IP address defined in the IP-interface. By default, the IP address of the GigaVUE-FM interface is displayed.
9. In the **Source Traffic** section, select a source port that require application monitoring in the **Source ports** field. Source port can be a single port, multiple ports, and port groups.
10. Configure the rules for filtering the required traffic in the **L2-L4 Rules** fields. To configure a rule:
 - a. Click **Select Conditions**. Select the required parameters from the drop-down list.
 - b. Select the value for the parameters from the drop-down.
 - c. Select the required options:
 - Pass or Drop - Based on the parameter selected in the Conditions fields, the traffic that matches the conditions will either be passed or dropped.
 - Bidirectional - Allows the traffic in both directions of the flow.

NOTE: Click "+" to create multiple rules for filtering the required traffic, and click "+ **New Source Traffic**" to create multiple sources with filtering options.

11. Click **Save**. The session created is added in the list view.

The total applications participating in the network traffic are displayed in the Application Intelligence Dashboard. For more information about the dashboard, refer to the [View the Application Intelligence Dashboard](#).

If the session configuration is unsuccessful, troubleshoot the error notified (refer to [View the Health Status of a Solution](#)). Click the **Reapply all pending solutions** button  in the dashboard to redeploy the configuration.

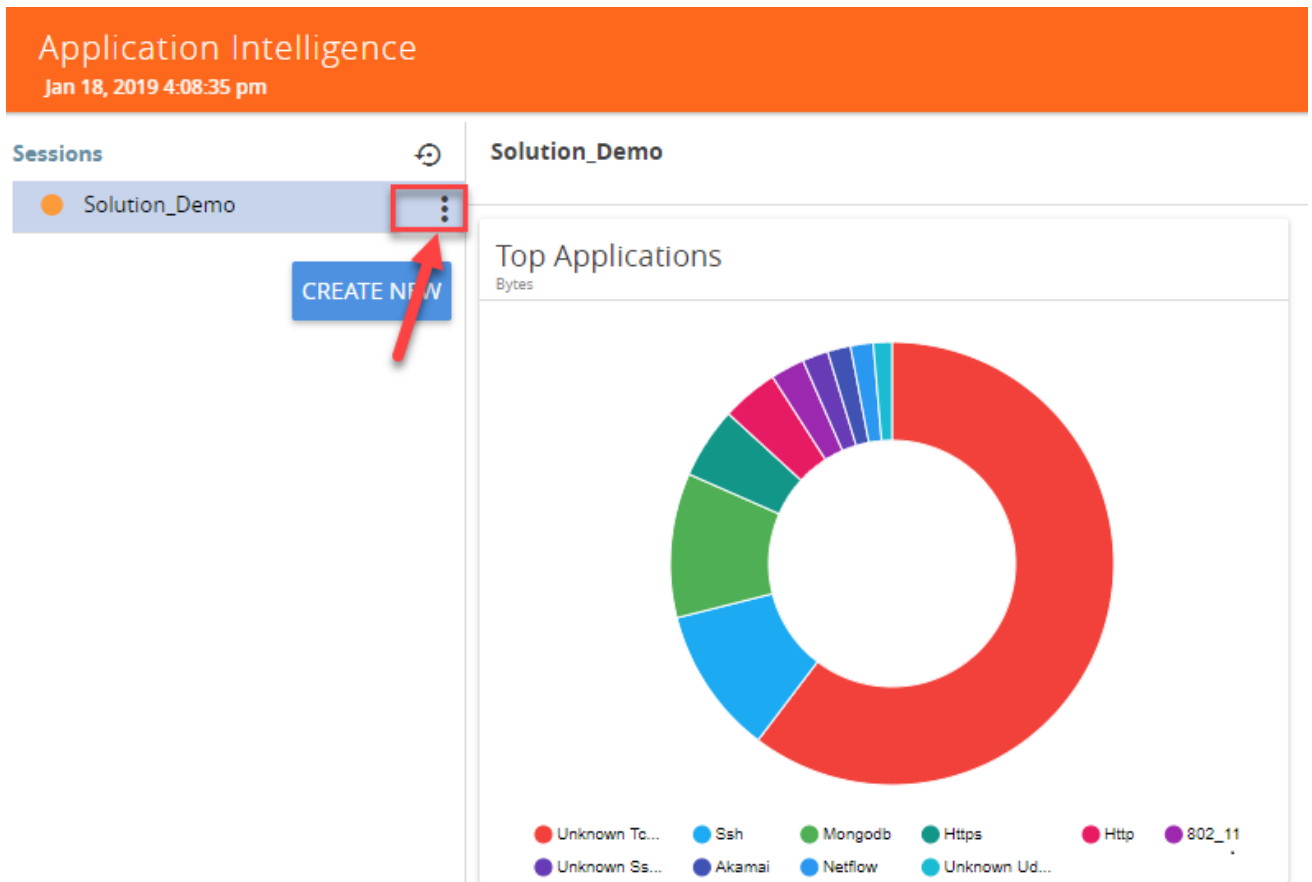
NOTE: GigaVUE-FM takes few seconds to display the application statistics.

You can also filter the traffic based on the applications. For more information, see [Create Application Filtering Intelligence](#).

View the Details of an Application Intelligence Session

To view the details and the statistics of a session, do the following steps:

1. Select the session from the **Application Intelligence Sessions** pane for which you need to view the sessions details, health status and statistics, and click the ellipsis as shown:

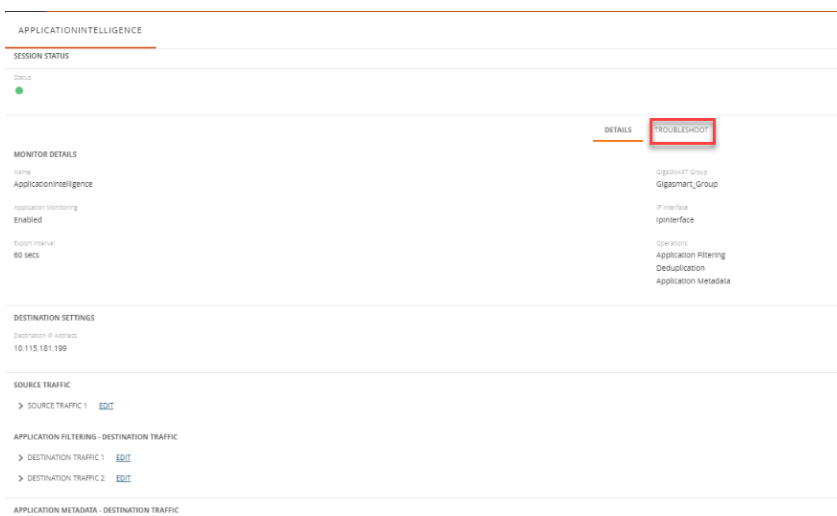


2. Select **View Details** from the drop-down list.

You can view the Monitoring Details, Destination Settings, Source Traffic, and Application Filtering-Destination Traffic, and Application Metadata-Destination Traffic in the Details page.

NOTE: You can edit the Source Traffic, Application Filtering-Destination traffic, and Application Metadata-Destination Traffic from the view details window.

3. Click **Troubleshoot** to view the current statistics and health status of components associated with the solution.



The details of the components that can be viewed for a solution are shown in the following table:

Components	Details of Components
Source Traffic	<ul style="list-style-type: none"> • Network Ports • First Level Maps • L2-L4 Rules
GigaSMART	<ul style="list-style-type: none"> • GigaSMART Port • GigaSMART Group • Virtual Port
Application Monitoring	<ul style="list-style-type: none"> • IP interface • Exporter
Application Filtering - Destination Traffic	<ul style="list-style-type: none"> • Second Level Map • Applications and Advanced Rules • Tool Ports • GigaSMART Operation (GSOP)
Application Filtering	<ul style="list-style-type: none"> • Application Session Filtering
Application Metadata	<ul style="list-style-type: none"> • IP Interface • Cache • Metadata Tools

The troubleshooting page has a flow diagram representing the components associated to the solution. You can also click on the blocks in the flow diagrams to view the details of the corresponding components.

To learn more about the color indication and the health status of a solution refer to [View the Health Status of a Solution](#).

Create Application Filtering Intelligence

Application Filtering Intelligence functionality on GigaSMART allows filtering of traffic based on the application (such as YouTube, Netflix, Sophos, or Facebook) or application family (such as antivirus, web, erp, or instant-messaging).

Application Filtering Intelligence supports filtering over 3200 applications.

You can create Application Filtering Intelligence in GigaVUE-FM by following either of the two ways:

- [Create Application Filtering Intelligence by Selecting Applications from Dashboard](#)
- [Create Application Filtering Intelligence by Editing Monitoring Session from Dashboard](#)

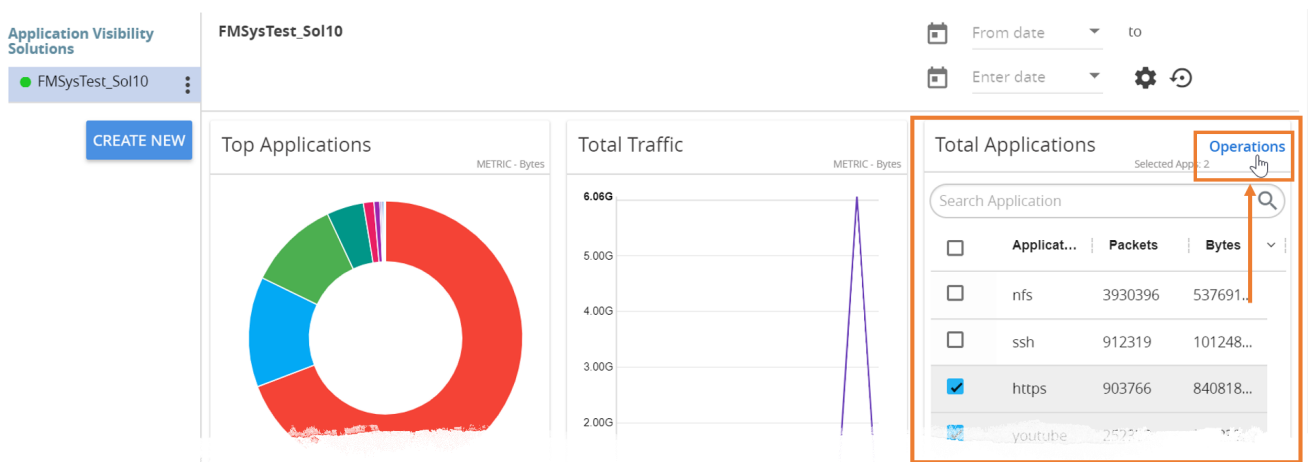
Create Application Filtering Intelligence by Selecting Applications from Dashboard

GigaVUE-FM allows you to create Application Filtering Intelligence by selecting the applications available from the **Total Applications** displayed on the Application Intelligence dashboard. To create Application Filtering Intelligence, follow these steps:

1. Go to **Physical > Physical Nodes**.
2. Click the Cluster ID to open a device.
3. Click **App Intelligence**.

NOTE: If you are creating Application Filtering Intelligence immediately after creating Application Monitoring, then you can proceed from Step 4.

4. Select the required application from the **Total Applications** in the right pane of the Application Intelligence dashboard. You can also select multiple applications for creating the Application Filtering Intelligence.
5. Click **Operations**, and select **App Filtering** from the drop-down list.




You can view the list of applications selected in the **Selected Applications** section.

6. Select either the **Pass** or **Drop** check box for an application to allow it to either pass through or get dropped off in the tool port present in the **Destination Traffic Priority**. You can also perform a search operation to filter the required application from the list of applications.
7. Use the **Destination Traffic Priority** section, to either choose the available tool port or add a new port for creating a traffic priority. In the **Select ports...** field, select the tool ports for sending the filtered applications traffic to the external tool. If you are unable to view the required port in the **Port** field, perform these steps:
 - Click **Port Editor**. Select the **Type** as **Tool** from the drop-down list for the required **Port Id**. Select **OK**.
The selected Port appears in the list.
 - Click **Save**.

NOTE: You can select the Null Port option, when you need to collect only the application metadata without sending the filtered traffic to any physical port.

8. In the **Priority** section, you can perform the following actions:
 - Enable the **Pass All** check box to pass all the applications when there are no matching rules.
 - Click **Advanced Rules > Add a rule** to add new rules to perform advanced filtering on the application.
9. In the **Destination Traffic Priority** section, click **+ Add New** to create additional **Destination Traffic Priority** (second level maps). In Application Filtering Intelligence, you can create a maximum of five Destination Traffic Priorities.

NOTE: You can click and drag the icon  to reorder the map priority when there are multiple priorities.

10. Click **Filter to** button for the corresponding **Priority** in a **Destination Traffic Priority** section for passing and dropping the applications to the required tool ports.

In the **Application Filtering Intelligence Settings**, you can edit the following options while creating the application filtering intelligence:

- Bidirectional (Default option).
- Buffer/Buffer count - The option is enabled default.
- Protocol- The default value is TCP-UDP.
- Packet Count
- Timeout in seconds - The default value is 15 seconds.
- Sessions Field

11. Click **Save**.

You can view the **Application Filtering Intelligence** Statistics from the Application Intelligence Dashboard page.

Create Application Filtering Intelligence by Editing Monitoring Session from Dashboard

You can select the required Applications from the list of applications in the Application Editor by following these steps:

1. Go to **Physical > Physical Nodes**.
2. Click the Cluster ID to open a device.
3. From the navigation pane, click **App Intelligence**.
4. In the left pane of **Application Intelligence** dashboard, hover over the monitor sessions for which you need to apply the **Application Filtering**, and click the vertical ellipsis from the **Application Intelligence Solutions**.
5. Click **Edit** from the Actions drop-down list.
6. Click the **App Editor** to select the applications to be passed or dropped.

The Application Editor screen appears as shown:

- Click the **Application Family** field and select an Application Family such as antivirus, webmail that needs to be filtered from the traffic. You can also select multiple application families. When you select an Application Family, you can search and select the applications related to the corresponding family.

If you choose to add or delete all the applications in a family, click **Add All Application in Families** or **Delete All Application in Families**.

- Click the **Application** field and select an application or multiple applications that needs to be filtered from the traffic.

NOTE: GigaVUE-FM allows you to select the required application even without selecting the Application family. You must select the non-TLS version for the below TLS version protocol:

- SMTPS
- POP3S
- IMAPS
- FTPS
- LDAPS

The selected protocols and their families appear in the **Selected Applications** field.

- Click **Add**. The selected applications appear in the **Application Filtering** tab.
- Perform the steps 7 and 8 in the [Create Application Filtering Intelligence by Selecting Applications from Dashboard](#).

After creating the Application Filtering Intelligence Session, you can view the **Application Filtering Traffic** statistics in the Application Intelligence Dashboard.

View the Application Intelligence Dashboard

After creating the Application Intelligence Session, you can monitor the applications in the network by the reports displayed in the Dashboard as shown in [Figure 355: Application Intelligence Dashboard](#):

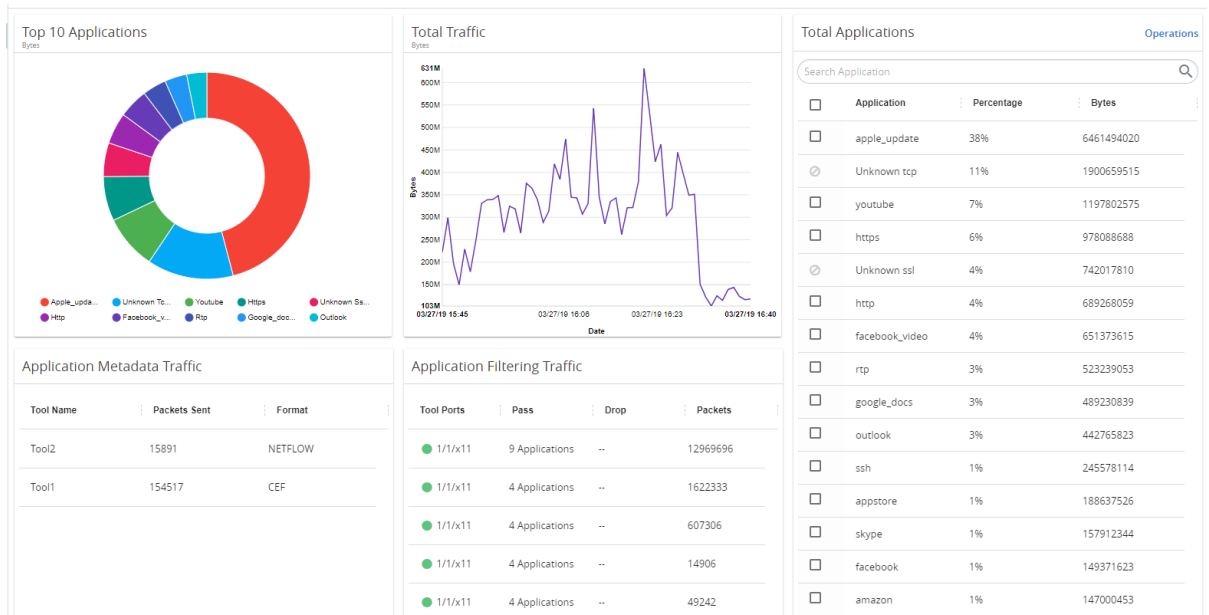



Figure 355: Application Intelligence Dashboard

Application Intelligence Dashboard displays the following metrics:

- **Top 10 Applications:** You can view a graphical representation of top 10 applications running in the network based on the metrics. When you hover over the Pie-chart, GigaVUE-FM shows the application name in the network. The legend for the Pie-chart appears at the bottom. When you select a pie, you can view the corresponding data highlighted in the Total Applications table.
- **Total Traffic:** You can view the total traffic of the network represented in the linear form of a graph.
- **Total Applications:** You can view the applications and their bandwidth in the network. You can also select the required application for filtering and exporting metadata by using the Operations field.
- **Application Filtering Traffic:** You can view the statistics of the applications that are filtered in the tool ports in the dashboard after creating an application filtering intelligence session for a device. You can view the number of applications that are dropped and passed through for the Application Filtering Traffic.
- **Application Metadata Traffic:** You can view the details of the Tool Name and the Format in which the metadata of the application is exported.

GigaVUE-FM enables you to view the above metrics for a particular period by selecting the date and time from the dashboard. You can also choose to view the graphs in the dashboard for the metrics in bytes, packets or flows. To view the metrics in bytes, packets or flows, click the gear  button in the right corner of the Application Intelligence dashboard.

NOTE: By default, you can view the metrics in the dashboard for the last one hour, if the period is not selected.

About De-duplication

Required License: De-duplication

Duplicate packets are common in network analysis environments where both the ingress and egress data paths are sent to a single output (for example, as a result of a SPAN operation on a switch). They can also appear when packets are gathered from multiple collection points along a path. GigaSMART de-duplication lets you eliminate these packets, only forwarding a packet once and thus reducing the processing load on your tools. For more information, refer to the [GigaSMART De-Duplication](#).

To enable De-duplication in the Application Filtering Intelligence or Application Metadata Intelligence, click **De-duplication**.

NOTE: You must install licenses for De-duplication and Application Metadata Intelligence on your GigaSMART Modules for enabling the features in GigaVUE-FM. Application Filtering Intelligence and De-duplication can be combined on the same GigaSMART engine.

Create Application Metadata Intelligence

Application Metadata Intelligence generates more than 5000 attributes for more than 3200 applications without impacting the users, devices, applications, or the network appliances. The feature identifies applications even when the traffic is encrypted.

The generated metadata is exported in IPFIX (IP Flow Information Export) format and CEF (Common Even Format) to security analytics and forensics tools thereby providing greater visibility to enforce corporate compliance.

Application Metadata Intelligence generates metadata only if the application is allowed to be passed in Application Filtering Intelligence. For example, Application Metadata Intelligence has the capability to generate metadata for HTTP traffic only if Application Filtering Intelligence filters in the HTTP traffic.

You can create an Application Metadata Intelligence session by following either of the two ways:

- [Create Metadata Intelligence by Selecting Applications from Dashboard](#)
- [Create Metadata Intelligence by Editing Monitoring Session from Dashboard](#)

Create Metadata Intelligence by Selecting Applications from Dashboard

You can create an Application Metadata Intelligence session in GigaVUE-FM by selecting the applications available from the Total Applications displayed on the Application Intelligence dashboard.

To create an Application Metadata Intelligence session, follow these steps:

1. Go to **Physical > Physical Nodes**.

2. Click the Cluster ID of the device.

You must configure Application Intelligence session to monitor the application on the network and to display them on the **Total Applications**. To create Application Intelligence session refer to [Create an Application Intelligence Session](#).

3. From the navigation pane, click **App Intelligence**. Select the applications from the **Total Applications** in the right pane of the Application Intelligence dashboard.

4. Click **Operations** and select **App Metadata** from the drop-down list.

You can view the list of applications selected in the **Selected Applications** section.

Application Metadata Intelligence generates more than 5000 attributes for more than 3200 applications without impacting the users, devices, applications, or the network appliances. The feature identifies applications even when the traffic is encrypted.

5. Expand the application and select the attributes to be extracted.

NOTE: You can select the attributes only if the application has attributes. If Application Filtering Intelligence License is available, you must create Application Filtering to create Application Metadata Intelligence. For more information, refer to [Create Application Filtering Intelligence by Selecting Applications from Dashboard](#).

6. In the **Destination Traffic** section, you can attach five exporters to a GigaSMART group. To add an exporter, click **+ Add New** and enter the following information:

- a. **Tool Name** - Enter the name of the tool to which you want to export the application-specific metadata.
- b. **Tool IP Address** - Enter the IP address of the tool to which you want to export the application-specific metadata. You can provide either IPv4 or IPv6 address.

- c. **IP Interface** - Select the IP interface through which the GigaVUE-FM needs to export the application-specific metadata to the tools. You can select either IPv4 or IPv6 interface. Provide IPv4 address as the destination address for IPv4 interface and provide IPv6 address as the destination address for IPv6 interface. You can also choose to create a new IP Interface.
- d. **Tool Template** - Select the tool template containing the list of applications and attributes that needs to be exported.

NOTE: When you create a session with flow-behaviour as bi-directional, GigaVUE-FM allows you to select Netflow v5 and v9 templates. When you edit the same session, you cannot select the Netflow v5, and v9 templates.


- e. Enter the L4 Source Port, and the L4 Destination Port details.

NOTE: If the export format is CEF, the default value for L4 destination port is 514. If the export format is NetFlow, the default value for L4 destination port is 2055.

- f. Select the Format as CEF or NetFlow from the **Format** drop-down list.
- g. Select the Record/Template type as either of the following:
 - Segregated - The application-specific attributes and the generic attributes will be exported as an individual record to the tool.
 - Cohesive- The application-specific attributes and the generic attributes will be combined as a single record and exported to the tool.
- h. Enter the Active Timeout, InActive Timeout and Template Refresh time interval.

NOTE: The format and the record/template type get selected automatically, after selecting the Tool Template.

7. In the **Advanced Settings > Collects** section, you can select the following packet attributes:
 - Counter - Select the Bytes, and Packets.
 - IPv4 - Select the required attributes. By default, Source Address, Destination Address, and Protocol are enabled.
 - IPv6 - Select the required attributes. By default, Source Address, Destination Address, and Next Header are enabled.
 - Transport -Select the required attributes. By default, Source Port, Destination Port are enabled.

By default, the above collect types are displayed. Click  to add the following collect types:

- Data Link - Select any one of the parameters such as Source Mac, Destination Mac and VLAN.
- Timestamp - Select the required timestamp such as System Uptime First, Flow Start, System Uptime Last, and Flow End.
- Flow - Select the parameter as End Reason if required.
- Interface - Select any one of the parameter such as Input Physical, Output Physical and Input Name.

8. In the **Application Metadata Settings** section:

- a. Select the Flow Behavior as any one of the following:
 - Uni-Directional
 - Bi-Directional. The default value is Bi-Directional.
- b. Enter the Timeout and Cache Size. The cache size range allowed for different platform is given in the following table:

Platform	Range in million
GigaVUE-HC1	1
GigaVUE-HC2	1
GigaVUE-HC3	1-2

- c. If you want to include the VLAN ID along with the 5-tuple to identify the traffic flow, select the **Data Link** and enable the **VLAN** option.
- d. In the **Observation Domain ID** field, enter a value to identify the source from where the metadata is collected. The range is from 0 to 255.

For example: If you enter 5 in this field, then the observation domain ID is calculated as follows:

Observation Domain ID (4-Bytes)	
Byte 1	0
Byte 2	1

Observation Domain ID (4-Bytes)	
Byte 3	GS engine slot (for e.g. 2 if 1/2/e1)
Byte 4	User defined (for e.g. 5). Default : 0.

The calculated value of Observation Domain Id in Hexadecimal is **00 01 02 05**, and in Decimal is **66053**.

- In the **Selected Applications** section, select **Export** and click **Export To** for the applications that needs to be exported to the destination tool.
- Click **Save**.

Create Metadata Intelligence by Editing Monitoring Session from Dashboard

You can create an Application Metadata Intelligence session in GigaVUE-FM by editing the monitoring session.

To create an Application Metadata Intelligence session, follow these steps:

- Go to **Physical > Physical nodes**.
- Click the Cluster ID of the device.
- From the navigation pane, click **App Intelligence**.
- In the **Edit Application Intelligence Session** window, click **Application Metadata**.

NOTE: If Application Filtering Intelligence License is available, you must create Application Filtering to create Application Metadata Intelligence. For more information, refer to [Create Application Filtering Intelligence by Editing Monitoring Session from Dashboard](#)

- In the **Destination Traffic** section, click **+Add New** to create an exporter to receive application-specific traffic. You can also create multiple exporters.
 - Enter the Tool Name, Tool IP address, L4 Source Port, L4 Destination Port, and select the IP Interface, and Template.
 - Click **App Editor**, to select the applications and its attributes. You can select a maximum of 64 attributes for each of the application. The Application Editor screen appears as shown:

The screenshot shows a web interface for selecting application families and applications. At the top, there are two main sections: 'APPLICATION FAMILY' and 'APPLICATIONS'. Under 'APPLICATION FAMILY', there are two buttons: 'antivirus X' and 'audio-video X', followed by the text 'Select Application Families'. Below these are two more buttons: 'ADD ALL APPLICATION IN FAMILIES' and 'DELETE ALL APPLICATION IN FAMILIES'. The 'APPLICATIONS' section has a 'Select Applications' button. Below these sections is a table titled 'SELECTED APPLICATIONS'. The table has two columns: 'Application (1)' and 'Family'. One row is visible with the application '6play (6play)' and the family 'audio-video'. At the bottom right of the interface are 'CANCEL' and 'ADD' buttons.

- Select an **Application Family** and the **Applications** that needs to be filtered from the traffic. You can also select **Add All Applications in Family** or **Delete All Applications in Family**.


NOTE: You can select the required applications without selecting the application family.

You must select the non-TLS version for the below TLS version protocol:

- SMTPS
- POP3S
- IMAPS
- FTPS
- LDAPS

The selected applications and their families appear in the **Selected Applications** section.

- Click **Add**. The selected applications appear in the **Application List** section.
- In the **Advanced Settings > Collects** section, you can select the following packet attributes:
 - Counter - Select the Bytes, and Packets.
 - IPv4 - Select the required attributes. By default, Source Address, Destination Address, and Protocol are enabled.
 - IPv6 - Select the required attributes. By default, Source Address, Destination Address, and Next Header are enabled.
 - Transport -Select the required attributes. By default, Source Port, Destination Port are enabled.

By default, the above collect types are displayed. Click  to add the following collect types:

- Data Link - Select any one of the parameters such as Source Mac, Destination Mac and VLAN.

- Timestamp - Select the required timestamp such as System Uptime First, Flow Start, System Uptime Last, and Flow End.
 - Flow - Select the parameter as End Reason if required.
 - Interface - Select any one of the parameter such as Input Physical, Output Physical and Input Name.
6. Perform the step 8 in [Create Metadata Intelligence by Selecting Applications from Dashboard](#).
 7. Click **Save**.

The metrics of the Application Metadata traffic appear on the dashboard.

Tool Templates

Tool template in Application Metadata Intelligence predefines a list of application, its attributes, and the format in which it needs to be exported to the tools. A template once created can be used by multiple exporters to export the attributes in a specified format to the destination tools.

You can use the tool templates while creating an Application Metadata Intelligence session. By default, you can find the following tool templates:

- BroMetadata Template
- Netflow V5 Template
- SplunkMetadata Template.

You cannot edit the above templates.

You can create tool templates according to your requirements. You can also edit and clone the templates. Refer to [Create Custom Tool Template](#) for more information.

Create Custom Tool Template

To create a customized Tool Template, do the following:

1. Go to **Physical > Physical nodes**.
2. Click the Cluster ID of the device.
3. From the left navigation pane, click **App Intelligence > Tool Templates**.
You can view two system defined templates by default.
4. Click **Create**. The **New Template** page appears.
5. Enter the **Template Name**.
6. Click the **App Editor** button. The **App Editor** page appears.

- a. Click the **Application Family** field and select an Application Family such as antivirus, webmail that needs to be filtered from the traffic. You can also select multiple application families.


If you choose to add or delete all the applications in a family, click Add All Application in Families or Delete All Application in Families.

NOTE: You can select the required applications without selecting the application family.

- b. Click the **Application** field and select an application or multiple applications that needs to be exported from the traffic.
 - c. Click **Add** to add the Application details.
7. Select the format (CEF/Netflow) in which the application details need to be exported to the tool.
 8. Select the record or template type:
 - Segregated - The application-specific attributes and the generic attributes will be exported as individual records to the tool.
 - Cohesive- The application-specific attributes and the generic attributes will be combined as a single record and exported to the tool.
 9. Enter the **Active timeout** and **Inactive timeout** in seconds.

NOTE: Select the Version and the Template Refresh Interval for the Netflow format.

10. In the **Advanced Settings > Collects** section, you can view and configure the following collect types:
 - Counter - Select the Bytes and Packets.
 - IPv4 - Select and enter the required information in the fields such as Source Address, Destination Address, Fragmentation, and Header Size and Payload Size.
 - IPv6 - Select and enter the required information in the fields such as Source Address, Destination Address, Fragmentation, and Header Size and Payload Size.
 - Transport -Select and enter the required information in the fields such as Source Address, Destination Address, and Header Size and Payload Size.

By default, the above collect types are displayed. Click  to add the following collect types:

- Data Link - Select any one of the parameters such as Source Mac, Destination Mac and VLAN.
- Timestamp - Select the required timestamp such as System Uptime First, Flow Start, System Uptime Last, and Flow End.

- Flow - Select the parameter as End Reason if required.
- Interface - Select any one of the parameter such as Input Physical, Output Physical and Input Name.

11. Click **Save**. The new tool template is added to the list view.

12. Select a tool template and click the ellipsis to perform the following:

- View Details - To view the details in the template.
- Edit - To edit the parameters and fields in the template.
- Delete - To delete the template from the list.
- Duplicate - To duplicate the template in the list.

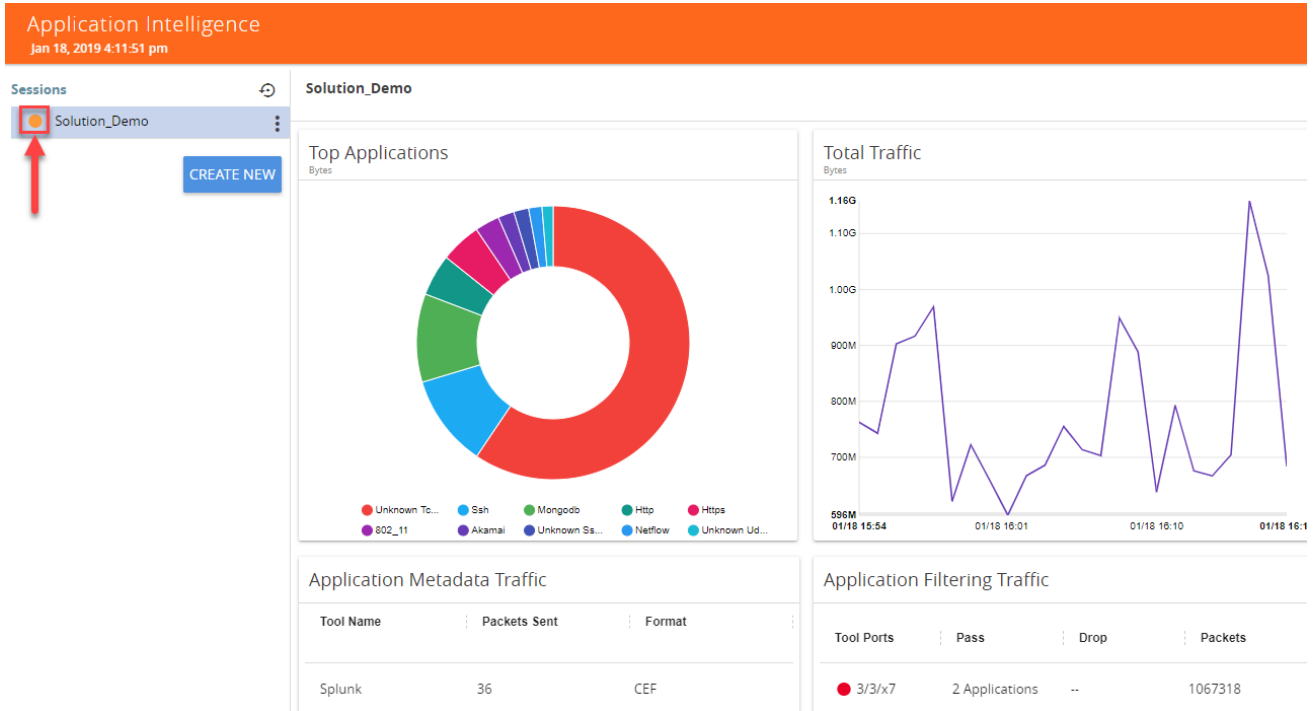
NOTE: You can edit an existing template and the attributes associated with it as required, and save the updates as a new template while creating an Application Metadata Intelligence session.

View the Health Status of a Solution

The health of an Application Intelligence solution is determined by the health status of the following components, and the configuration status during deployment of the solution in a device:

- IP interface
- Source Port
- Destination Port
- GigaSMART Engine


You can view the health status of the solution by a color indication next to the name of the solution as shown in the following figure:



The health status of a solution is indicated by the following colors:

Color	Health Status of a Solution
Green	Healthy - All the components in a solution are functioning properly.
Red	Unhealthy - Any of the components in a solution is not functioning properly.
Amber	Partially Healthy

You can also view the reason for a failover when you hover your mouse over the color indicator next to the name of the solution. To avoid this scenario:

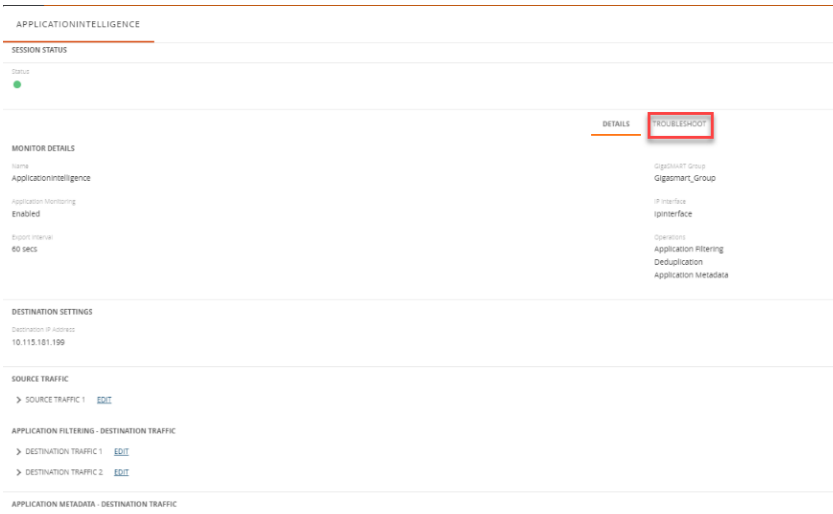
1. On the right side of the top navigation bar, click .
2. On the left navigation pane, select **System** > **Thresholds**.
3. Set the threshold value of GigaSMART engine port packet drops to zero.

The following table provides the health state of the Application Intelligence solution corresponding to the health state of its associated components:

Table 59: Health status of Solution Vs Health status of Associated Components

Health Status of a Solution	GSGroup	IP Interface	Network Port and Tool Port	Metadata Exporter	Configuration Deployment Status
Red	Unhealthy	Healthy	Healthy	Healthy	Success
Amber	Partially Healthy	Healthy	Healthy	Healthy	Success
Red	Healthy	Unhealthy	Healthy	Healthy	Success
Amber	Healthy	Partially Healthy	Healthy	Healthy	Success
Amber	Healthy	Healthy	Some Maps are Unhealthy/Partially Healthy	Healthy	Success
Red	Healthy	Healthy	All Maps are Unhealthy	Healthy	Success
Red	Healthy	Healthy	Healthy	All Metadata Exporters are Unhealthy	Success
Amber	Healthy	Healthy	Partially Unhealthy	Healthy	Success
Amber	Healthy	Healthy	Healthy	Some metadata exporters are Unhealthy	Success
Red	Healthy	Healthy	Healthy	Healthy	Failed
Amber	Healthy	Healthy	Healthy	Healthy	Partial Success
Red	Healthy	Healthy	Healthy	Healthy	Failed
Green	Healthy	Healthy	Healthy	Healthy	Success

To view the details of a solution, click **View details** > **Troubleshoot**. For more details, refer to [View the Details of an Application Intelligence Session](#).



The solution page provides you the details of the health status of its associated components.

GigaSMART Application Session Filtering (ASF) and Buffer ASF

Required Licenses: Adaptive Packet Filtering (APF) and Application Session Filtering (ASF)

NOTE: The ASF license requires the APF license to be installed as a prerequisite.

DEPRECATION ANNOUNCEMENT: GigaSMART Application Session Filtering is end-of-sale in 5.6.00. Refer to the [Application Intelligence](#) to learn about the feature set and licensing for the improved application filtering and application metadata functionality.

Application Session Filtering (ASF) provides additional filtering on top of Adaptive Packet Filtering (APF). With APF, you can filter on any data patterns within a packet. With ASF, you apply the pattern matching and then send all the packet flows associated with the matched packet to monitoring or security tools.

ASF allows you to filter all traffic corresponding to a session. Use ASF to create a flow session and send the packets associated with the flow session to one or more tools. A flow session consists of one or more fields that you select to define the session. Either the packets for the whole session can be captured or only the packets following a pattern match.

For example, use APF to filter TCP packets to capture the SYN packet. Then use ASF with GigaSMART Load Balancing to send all subsequent packets associated with the session to multiple tool ports. This example is illustrated in [Example 1: ASF, Forward TCP Traffic](#). For information on capturing a whole session by buffering packets, refer to [Application Session Filtering with Buffering](#).

Or use APF to create pattern-matching filters in which the pattern is a sequence of data bytes at a variable or fixed offset within a packet. Then use ASF with a specified session definition to capture subsequent packets belonging to the session. When an incoming packet matches an APF rule, a flow session is created. The subsequent incoming packets that match the value of the fields in the flow session will be forwarded to the same tool port as the matching packet.

For example, use APF to pattern match the string *www.gigamon.com*. Use the 5tuple field to identify the flow session. This creates the signature of the session. All the packets associated with the session will be forwarded to a tool port, hence APF becomes flow-aware or session-aware.

ASF provides the following session capabilities:

- filter on one, two, or both MPLS labels and/or VLAN IDs
- filter on both inner and outer IP addresses, Layer 4 ports, and protocols

Pattern matching examples are illustrated in [Pattern Match with Type String](#) to [Example 4: ASF, Forward GTP Traffic](#)

For information on load balancing, refer to stateful load balancing in the section [GigaSMART Load Balancing](#).

ASF operations can be assigned to GigaSMART groups consisting of multiple engine ports. Refer to [Groups of GigaSMART Engine Ports](#) for details.

In ASF and buffer ASF second level maps, a maximum of five (5) maps can be attached to a virtual port (vport). Each map can contain up to 25 gsrules.

Application Session Filtering (with or without buffering) is a pillar of the GigaSECURE Security Delivery Platform. Refer to [GigaSECURE Security Delivery Platform](#).

Session-Aware APF (SAPF) Renaming and Licensing Change to ASF

The GigaSMART feature named Session-Aware Adaptive Packet Filtering (SAPF) in GigaVUE-OS 4.3 was renamed to Application Session Filtering (ASF) in GigaVUE-OS 4.4. It is now encompassed within ASF as the non-buffering equivalent to Application Session Filtering with buffering.

In addition, the license has moved from the APF license to the ASF license.

Application Session Filtering with Buffering

ASF captures packets of a session after an APF rule match. When the APF match occurs in the middle of a session, packets in the session prior to the match are not captured. With some tools needing all the packets of a flow session in order to perform data analysis, GigaSMART uses buffering to ensure

that all packets belonging to a flow session are captured and forwarded to the tools. This is referred to as Application Session Filtering with buffering, or buffer ASF.

Buffer ASF uses the pattern-matching and regular expression engine in APF to select packet flows based on matching criteria with one or more packets in the flow session. Buffering ensures that the entire session, from start to finish, is either dropped or forwarded to the security tools or the performance monitoring tools.

To capture all packets belonging to a flow session prior to the APF rule match, ASF needs to know the first packet of a flow session. For this, GigaSMART supports both TCP and UDP connections.

For TCP connections, the TCP SYN packet is used to indicate the start of a session. GigaSMART captures and stores (or buffers) all packets of a flow session until an APF match occurs. After that, GigaSMART will either forward or drop all stored packets belonging to that session based on the APF pass or drop rule that is configured. Subsequent packets after the APF match will be forwarded or dropped as they arrive.

For UDP connections, there is no special packet that indicates the start of a UDP flow session from a Layer 4 perspective. GigaSMART will take the first UDP packet of a session it encounters as the start of a session flow. This may result in incomplete capture at the beginning of configuration or at system boot up, but as new UDP sessions arrive, GigaSMART will capture the first packet of the flows.

ASF and Buffer ASF Session Definitions

Use the **Session Field** of the **ASF** page to define ASF and buffer ASF sessions by specifying session field attributes to add or delete. A session field is a group of one or more fields that define a flow session. (From the device view, select **GigaSMART > ASF** and click **New** to open the ASF page.)

A flow session consists of field names and attributes. Some field names include multiple attributes, which provide a quick way to define sessions.

The field names and attributes are as follows:

- gtpu-teid
- ipv4 (ipv4-src, ipv4-dst)
- ipv4-5tuple (ipv4-src, ipv4-dst, l4port-src, l4port-dst, ipv4-protocol)
- ipv4-dst
- ipv4-l4port-dst (ipv4-src, ipv4-dst, l4port-dst)
- ipv4-protocol
- ipv4-src
- ipv4-src-l4port-dst (ipv4-src, l4port-dst)

- ipv6 (ipv6-src, ipv6-dst)
- ipv6-5tuple (ipv6-src, ipv6-dst, l4port-src, l4port-dst, ipv6-protocol)
- ipv6-dst
- ipv6-l4port-dst (ipv6-src, ipv6-dst, l4port-dst)
- ipv6-protocol
- ipv6-src
- ipv6-src-l4port-dst (ipv6-src, l4port-dst)
- l4port (l4port-src, l4port-dst)
- l4port-dst
- l4port-src
- mpls-label
- vlan-id

An ASF session definition consists of combinations of the fields and attributes in the list above. In addition, for all IP and L4 port fields in the packet, each ASF session field must specify **outer** or **inner** for location. Outer specifies the first IP or L4 port in the packet. Inner specifies the second IP or L4 port in the packet (usually inside tunneling). For VLAN ID and MPLS label fields, a position (1 or 2) must be specified. Position 1 is the first occurrence of the protocol header or field in the packet. Position 2 is the second occurrence of the protocol header or field in the packet.

A buffer ASF session definition consists of combinations of the fields and attributes in the list above. **One restriction is that ipv4-src or ipv6-src needs to be defined, as a minimum.** In addition, the following restrictions apply to buffer ASF session definitions:

- the gtpu-teid field name is not supported
- the IP and L4 port fields only support location **outer**
- the VLAN ID field only supports position 1

All packets belonging to the same source and destination IP will be considered as the same flow session. This is useful if you want to capture all packets belonging to separate TCP/UDP connections that have the same IPs, such as control or data flows.

Define ASF Session

When defining an ASF session, enter the fields, attributes, and options, then save. The changes only take effect when after you save. For example, in [Figure 356: An ASF Configuration](#), the settings are:

- Alias is asf2, which is name of the ASF Profile for the GigaSMART Operation
- buffer enabled

- Buffer Count before Match is 5
- ipv4-5tuple outer
- vlan-id position 1

ASF

Alias

Configuration

BI-directional Enable

Buffer Enable

Buffer Count before Match

Protocol TCP Only ▾

Packet Count Enable

Timeout secs

Session field	Position
Ipv4-5tuple ✕	<input type="radio"/> Outer
vlan-Id ✕	<input checked="" type="radio"/> 1

Figure 356: An ASF Configuration

Quick Session Delete for Buffer ASF

For a buffer ASF session defined with ipv4-5tuple or ipv6-5tuple, there is a quick session delete for TCP connections. The session is deleted 4 seconds after RST or both FIN packets are detected, signaling the end of the flow.

Specify Resources for Buffer ASF

On GigaVUE-HC3, GigaVUE-HC2, and GigaVUE-HC1 nodes buffer ASF supports from 2 to 5 million sessions. On GigaVUE-HB1, buffer ASF supports 2 million sessions.

The large number of sessions can use a lot of memory resources on the GigaSMART line card or module. Occasionally, the GigaSMART line card or module will need to be reloaded for changes to take effect and to allocate resources accordingly.

The GigaSMART line card or module does not need to be reloaded the first time buffer ASF resources are allocated. But subsequent changes, such as increasing from 3 million to 4 million sessions, or decreasing from 3 million to 2 million sessions will require a reload for the changes to take effect.

You can reload the card from the UI, by doing the following:

1. Select **Chassis** in the Navigation pane.
2. Clicking the Table View button to open the Table View of the Chassis.
3. Under Cards, select the card to reload.
4. From the **Actions** menu, select **Shut Down**.
5. Now select **Start Up** from **Actions** menu.

Alternatively, you can use the following GigaVUE-FM API to reload the card:

PATCH /inventory/chassis/cards/{slotId}

For more information about the GigaVUE-FM APIs, refer to the *GigaVUE-FM REST API Reference in GigaVUE-FM User's Guide*.

You can also reload the card with the following two CLI commands:

(config) # card slot <slot ID> down
(config) # no card slot <slot ID> down

For more information about the CLI commands, refer the *GigaVUE-OS-CLI Reference Guide*.

ASF and Buffer ASF Session Notes

The following table summarizes notes relating to ASF and buffer ASF:

Notes
A session field can only be modified or deleted if it is <i>not</i> configured in any GigaSMART operation.
A session field can only contain the same session attribute and position pair once.
A session field cannot contain overlapped session attribute and position. For example, the following is not valid: ipv4-5tuple outer and ipv4-src outer.
Up to a maximum of 25 flow session aliases are supported for ASF.
A total of 4 session tables per GigaSMART engine are supported for ASF. Each table has its own session definition.
Up to 2 million session entries are supported for ASF. The entries are shared by all session aliases.

Notes

Each session table (session alias) can only be used once within a gsgroup.

The number of buffer ASF sessions supported is configurable from 2 to 5 million.

The number of packet buffers supported for buffer ASF is from 2 to 5 million.

Buffer ASF Packet Processing Special Cases

The following are special cases of packet processing for buffer ASF:

- Non-TCP SYN packet received and no session matched—When a non-TCP SYN packet is received and there is no session matched, the packet will be considered as *no match* and will be passed to other maps. If there is no match after all maps have been processed, the packet will be forwarded to a shared collector, if one is configured.
- Out of session—When a TCP SYN packet is received and no free session is available, the packet will be considered as *no match*. Other packets belonging to this session will also be considered as *no match*, as for the special case described above.
- Out of packet storage buffer—When the buffer is full for the first packet of a session, the session will not be created and the packet will be considered as *no match*. When the buffer is full for an existing session, and the APF match has not yet occurred, a flag will be set and the current packet and all buffered packets will be considered as *no match*. Subsequent packets will also be considered as *no match*.
- Exceeded configured buffering limit—When there is no APF match after the configured number of packets have been buffered, all buffered packets and all subsequent packets belonging to this session will be considered as *no match*.

Map Statistics

Go to **Map > Statistics** to display counts of the rules that actually matched in a map. A single packet can match one or more rules. For example, if a single packet matches multiple rules in an ASF or buffer ASF map, all matching rules will have that packet counted against them and the overall map status pass counter will show 1.

ASF and Buffer ASF Examples

Refer to the following ASF examples (non-buffered):

- [Example 1: ASF, Forward TCP Traffic](#)
- [Pattern Match with Type String](#)
- [Example 3: ASF, Forward Traffic Matching a Pattern](#)

- [Example 4: ASF, Forward GTP Traffic](#)

Refer to the following buffer ASF examples:

- [Example 1: Buffer ASF, Drop Netflix Traffic](#)
- [Example 2: Buffer ASF, Drop YouTube Traffic](#)
- [Example 3: Buffer ASF, Drop Windows Update Traffic](#)
- [Example 4: Buffer ASF, Forward VNC Traffic](#)
- [Example 5: Buffer ASF, Forward HTTPS Traffic on Non-Standard Port](#)

Example 1: ASF, Forward TCP Traffic

In Example 1, ASF is used with GigaSMART Load Balancing and Adaptive Packet Filtering to load balance TCP traffic among multiple tool ports. TCP SYN indicates the start of a connection. Once the TCP SYN packet is detected, subsequent packets belonging to the same TCP connection will be forwarded to a configured tool port. Packets belonging to the same connection will be sent to the same tool port, regardless of the number of connections.

NOTE: This example uses APF to filter TCP packets to capture the SYN packet. Alternatively, use buffer ASF to capture a whole session by buffering packets.

Task	Description	UI Steps
1	Create a flow session.	<ol style="list-style-type: none"> 1. From the device view, select GigaSMART > ASF. 2. Click New. 3. Type asf4 in the Alias field. 4. Select ipv4-tuple from the Session field list. 5. Select outer. 6. Click Save.
2	Create a port group and specify the tool ports for load balancing.	<ol style="list-style-type: none"> 1. Select Ports > Port Groups > All Port Groups. 2. Click New. 3. Type portgrp1 in the Alias field. 4. Select Tool. 5. Select SMART Load Balancing. 6. Click in the Ports field and select the tool ports. For example, 1/1/x6, 1/1/x7, 1/2/x3, and 1/2/x4.
3	Configure a GigaSMART group and associate it with GigaSMART engine ports.	<ol style="list-style-type: none"> 1. From the device view, select GigaSMART > GigaSMART Groups > GigaSMART Groups. 2. Click New. 3. Type gsgrp1 in the Alias field. 4. Select two engine ports from the Port List field. For example,

Task	Description	UI Steps
		<p>1/3/e1 and 1/3/e2</p> <p>5. Click Save.</p>
4	Configure the combined GigaSMART operation.	<ol style="list-style-type: none"> 1. From the device view, select GigaSMART > GigaSMART Operations (GSOP) > GigaSMART Operation and create two GigaSMART Operations. 2. Click New. 3. Type gsop1 in the Alias field. 4. Select gsgrp1 from the GigaSMART Groups list. 5. Select the operations. <ul style="list-style-type: none"> • APF • ASF with asf4 for the ASF profile • Load Balancing with Stateful Type ASF, and Round Robin 6. Click Save.
5	Create a virtual port and associate it with the GigaSMART group.	<ol style="list-style-type: none"> 1. From the device view, select GigaSMART > Virtual ports. 2. Click New. 3. Enter vp1 in the Alias field. 4. Select gsg1 from the GigaSMART Groups list. 5. Click Save.
6	Create a first level map.	<ol style="list-style-type: none"> 1. Select Maps > Maps > Maps. 2. Click New. 3. Configure the map. <ol style="list-style-type: none"> a. Type map11 in the Alias field. b. Select First Level for Type. c. Select By Rule for Subtype. d. Select the network port 1/1/x1 for the Source. e. Select the virtual port vp1 for the Destination. 6. Add a rule. <ol style="list-style-type: none"> a. Click Add a Rule. b. Select Pass. c. Select IPv4 Version and set version to 4 4. Click Save.
7	Create a second level map. The gsrule captures the first packet of a session.	<ol style="list-style-type: none"> 1. Click New. 2. Configure the map. <ol style="list-style-type: none"> a. Type map22 in the Alias field. b. Select Second Level for Type. c. Select By Rule for Subtype. d. Select the virtual port vp1 for the Source. e. Select the port group portgrp1 for the Destination.

Task	Description	UI Steps
		<ol style="list-style-type: none"> f. Select gsop1 from the GSOP list. <ol style="list-style-type: none"> 7. Add a rule. <ol style="list-style-type: none"> a. Click Add a Rule. b. Select Pass. c. Select TCP Control. d. Enter 2 for Value. e. Enter 0 for Mask. f. Set Position to 1. 7. Click Save.

Example 2: ASF, Forward VNC Traffic

In Example 2, traffic from a Virtual Network Computing (VNC) application is forwarded from network port 1/1/x1 to tool port 1/1/x6. Packets will be matched with a VNC signature. Once a packet is matched, subsequent packets with the same IPv4 5tuple will be forwarded to the same destination as the matching packet. By default, both the forward and the reverse traffic of the same session will be captured and forwarded.

Step	Description	Command
1	Create a flow session.	<ol style="list-style-type: none"> 1. From the device view, select GigaSMART > ASF. 2. Click New. 3. Type asf1 in the Alias field. 4. Select ipv4-tuple from the Session field list. 5. Select outer. 6. Click Save.
2	Configure a GigaSMART group and associate it with GigaSMART engine ports.	<ol style="list-style-type: none"> 1. From the device view, select GigaSMART > GigaSMART Groups > GigaSMART Groups. 2. Click New. 3. Type gsgrp1 in the Alias field. 4. Select two engine ports from the Port List field. For example, 1/3/e1 and 1/3/e2 5. Click Save.
3	Configure the combined GigaSMART operation.	<ol style="list-style-type: none"> 1. From the device view, select GigaSMART > GigaSMART Operations (GSOP) > GigaSMART Operations and create two GigaSMART Operations. 2. Click New. 3. Type gsop1 in the Alias field. 4. Select gsgrp1 from the GigaSMART Groups list. 5. Select the operations.

Step	Description	Command
		<ul style="list-style-type: none"> • APF • ASF with asf1 for the ASF profile <p>6. Click Save.</p>
4	Create a virtual port and associate it with the GigaSMART group.	<ol style="list-style-type: none"> 1. From the device view, select GigaSMART > Virtual ports. 2. Click New. 3. Enter vp1 in the Alias field. 4. Select gsgrp1 from the GigaSMART Groups list. 5. Click Save.
5	Create a first level map.	<ol style="list-style-type: none"> 1. Select Maps > Maps > Maps. 2. Click New. 3. Configure the map. <ol style="list-style-type: none"> a. Type map11 in the Alias field. b. Select First Level for Type. c. Select By Rule for Subtype. d. Select the network port 1/1/x1 for the Source. e. Select the virtual port vp1 for the Destination. 6. Add a rule. <ol style="list-style-type: none"> a. Click Add a Rule. b. Select Pass. c. Select IPv4 Version and set Version to 4 4. Click Save.
6	Create a second level egress map. The gsrule contains the VNC signature.	<ol style="list-style-type: none"> 1. Click New. 2. Configure the map. <ol style="list-style-type: none"> a. Type map22 in the Alias field. b. Select Second Level for Type. c. Select By Rule for Subtype. d. Select the virtual port vp1 for the Source. e. Select the port group portgrp1 for the Destination. f. Select gsop1 form the GSOP list. 7. Add a rule. <ol style="list-style-type: none"> a. Click Add a Rule. b. Select Pass. c. Select Pattern Match. d. Select regex for Type and enter <code>^rfb 00[1-9]\.00[0-9]\x0a\$</code> e. Set Offset from 16 to 1000 6. Click Save.

Example 3: ASF, Forward Traffic Matching a Pattern

In Example 3, the traffic that matches a particular pattern (ymsg|ypns|yhoo) is forwarded from network port 1/1/x1 to tool port 1/1/x6 after adding a VLAN tag. Packets will be matched with the special signature. Once a packet is matched, subsequent packets with the same source IP, source port, and VLAN ID will be forwarded to the same destination as the matching packet (after the VLAN header is inserted). By default, both the forward and the reverse traffic of the same session will be captured and forwarded.

Task	Description	UI Steps
1	Create a flow session and other parameters.	<ol style="list-style-type: none"> From the device view, select GigaSMART > ASF. Click New. Type asf2 in the Alias field. Enable Packet Count. Set Number of packets to 50. Set the session field. <ul style="list-style-type: none"> Select ipv4-src outer Select vlan-id position 1 Select outer. Click Save.
2	Configure a GigaSMART group and associate it with GigaSMART engine ports.	<ol style="list-style-type: none"> From the device view, select GigaSMART > GigaSMART Groups > GigaSMART Groups. Click New. Type gsrp1 in the Alias field. Select two engine ports from the Port List field. For example, 1/3/e1 and 1/3/e2 Click Save.
3	Configure the GigaSMART operation.	<ol style="list-style-type: none"> From the device view, select GigaSMART > GigaSMART Operations (GSOP) > GigaSMART Operation and create two GigaSMART Operations. Click New. Type gsop1 in the Alias field. Select gsrp1 from the GS Groups list. Select the operations. <ul style="list-style-type: none"> Adaptive Packet Filtering Add Header and set VLAN to 1000 ASF with asf2 for the ASF profile Click Save.
4	Create a virtual port and associate it with the GigaSMART group.	<ol style="list-style-type: none"> From the device view, select GigaSMART > Virtual ports. Click New. Enter vp1 in the Alias field.

Task	Description	UI Steps
		<ol style="list-style-type: none"> 4. Select gsgp1 from the GigaSMART Groups list. 5. Click Save.
5	Create a first level map.	<ol style="list-style-type: none"> 1. Select Maps > Maps > Maps. 2. Click New. 3. Configure the map. <ol style="list-style-type: none"> a. Type map11 in the Alias field. b. Select First Level for Type. c. Select By Rule for Subtype. d. Select the network port 1/1/x1 for the Source. e. Select the virtual port vp1 for the Destination. 6. Add a rule. <ol style="list-style-type: none"> a. Click Add a Rule. b. Select Pass. c. Select IPv4 Version and set Version to 4 4. Click Save.
6	Create a second level map. The gsrule contains the special signature.	<ol style="list-style-type: none"> 1. Click New. 2. Configure the map. <ol style="list-style-type: none"> a. Type map22 in the Alias field. b. Select Second Level for Type. c. Select By Rule for Subtype. d. Select the virtual port vp1 for the Source. e. Select the too port 1/1/x6 for the Destination. f. Select gso1 from the GSOP list. 7. Add a rule. <ol style="list-style-type: none"> a. Click Add a Rule. b. Select Pass. c. Select Pattern Match. d. Select regex for Type and enter (ymsg ypns yhoo) e. Set Offsett from 16 to 1000 6. Click Save.

Example 4: ASF, Forward GTP Traffic

In Example 4, GTP traffic from network port 1/1/x1 is load balanced based on inner IP and tunnel ID to four tool ports: 1/1/x6, 1/1/x7, 1/2/x3, and 1/2/x4. APF filters GTP-u packets. Once a packet is matched, subsequent packets in the same direction with the same gtpu-teid and inner IP will be forwarded to the same destination as the matching packet. In Example 4, both the outer and inner IP are IPv4.

Task	Description	UI Step
1	Create a flow session and other parameters.	<ol style="list-style-type: none"> 1. From the device view, select GigaSMART > ASF. 2. Click New. 3. Type asf3 in the Alias field. 4. Set timeout to 90. 5. Set the session field. <ul style="list-style-type: none"> • Select gtpu-teid • Select Ipv4 inner 6. Select outer. 7. Click Save.
2	Create a port group and specify the tool ports for load balancing.	<ol style="list-style-type: none"> 1. Select Ports > Port Groups > All Port Groups. 2. Click New. 3. Type portgrp1 in the Alias field. 4. Select Tool. 5. Select SMART Load Balancing. 6. Click in the Ports field and select the tool ports. For example, 1/1/x6, 1/1/x7, 1/2/x3, and 1/2/x4.
3	Configure a GigaSMART group and associate it with GigaSMART engine ports.	<ol style="list-style-type: none"> 1. From the device view, select GigaSMART > GigaSMART Groups > GigaSMART Groups. 2. Click New. 3. Type gsgrp1 in the Alias field. 4. Select two engine ports from the Port List field. For example, 1/3/e1 and 1/3/e2 5. Click Save.
4	Configure the combined GigaSMART operation.	<ol style="list-style-type: none"> 1. From the device view, select GigaSMART > GigaSMART Operations (GSOPS) > GigaSMART Operation and create two GigaSMART Operations. 2. Click New. 3. Type gsop1 in the Alias field. 4. Select gsgrp1 from the GigaSMART Groups list. 5. Select the operations. <ul style="list-style-type: none"> • Adaptive Packet Filtering • ASF with asf3 for the ASF profile • Load Balancing with Stateful, Type ASF, and Least Conn 6. Click Save.
5	Create a virtual port and associate it with the GigaSMART group.	<ol style="list-style-type: none"> 1. From the device view, select GigaSMART > Virtual ports. 2. Click New. 3. Enter vp1 in the Alias field. 4. Select gsgrp1 from the GigaSMART Groups list. 5. Click Save.

Task	Description	UI Step
6	Create a first level map.	<ol style="list-style-type: none"> 1. Select Maps > Maps > Maps. 2. Click New. 3. Configure the map. <ol style="list-style-type: none"> a. Type map11 in the Alias field. b. Select First Level for Type. c. Select By Rule for Subtype. d. Select the network port 1/1/x1 for the Source. e. Select the virtual port vp1 for the Destination. 6. Add a rule. <ol style="list-style-type: none"> a. Click Add a Rule. b. Select Pass. c. Select IPv4 Protocol and set Value to UDP. d. Select Port Destination and set the port value to 2152 5. Click Save.
7	Create a second level map.	<ol style="list-style-type: none"> 1. Click New. 2. Configure the map. <ol style="list-style-type: none"> a. Type map22 in the Alias field. b. Select Second Level for Type. c. Select By Rule for Subtype. d. Select the virtual port vp1 for the Source. e. Select the port group portgrp1 for the Destination. f. Select gsop1 form the GSOP list. 7. Add a rule. <ol style="list-style-type: none"> a. Click Add a Rule. b. Select Pass. c. Select Pattern Match. d. Select IPv4 Protocol and enter the IPv4 address. Set Position to 1. e. Select Ipv4 Destination and set the port value to 2152. Set Position to 1. 6. Click Save.

Example 1: Buffer ASF, Drop Netflix Traffic

In Example 1, the goal is to drop all Netflix traffic. The flow session is defined by the 5tuple field and the first occurrence of VLAN ID. The Netflix traffic is expected to be identified in the first 6 packets of a session. (Configure the maximum number of packets buffered before the match to 5.) A maximum of 3 million sessions is specified.

Task	Description	UI Steps
1	Configure a GigaSMART group and associate it with GigaSMART engine ports and Define the maximum number of sessions, in millions.	<ol style="list-style-type: none"> 1. From the device view, select GigaSMART > GigaSMART Groups > GigaSMART Groups. 2. Click New. 3. Type gsgrp1 in the Alias field. 4. Select two engine ports from the Port List field. For example, 1/3/e1 and 1/3/e2 5. Under Params Resource Buffer select ASF and set the Buffer size to 3. 6. Click Save.
2	If needed, reload the GigaSMART line card or module to allocate the resources for buffer ASF.	<p>If you reset the buffer size of an ASF profile in Task 1, go to the Chassis page and select Table View. Under Cards, select the card to reload. From the Actions menu, select Shut Down and then Start Up.</p> <p>You can also issue the following CLI commands to reboot the card (the card is in slot 3 in this example):</p> <pre>(config) # card slot 3 down (config) # no card slot 3 down</pre>
3	<p>Create a flow session, specify the buffer count before the match, and enable buffering.</p> <div style="border: 1px solid black; padding: 5px; margin-top: 10px;"> <p>NOTE: The default protocol is TCP, so it does not need to be specified.</p> </div>	<ol style="list-style-type: none"> 1. From the device view, select GigaSMART > ASF. 2. Click New or select an existing ASF profile then click Edit. 3. Type asf2 in the Alias field if this is a new ASF profile. 4. Enable Buffer. 5. Set Buffer Count before Match to 5. 6. Set the session field. <ul style="list-style-type: none"> • Select ipv4-5tuple outer • Select vlan-id position 1 7. Click Save.
4	Configure the combined GigaSMART operation.	<ol style="list-style-type: none"> 1. From the device view, select GigaSMART > GigaSMART Operations (GSOP) > GigaSMART Operation and create two GigaSMART Operations. 2. Click New. 3. Select gsgrp1 from the GigaSMART Groups list. 4. Type gsop1 in the Alias field. 5. Select the operations. <ul style="list-style-type: none"> • APF • ASF with asf2 for the ASF profile
5	Create a virtual port and associate it with the GigaSMART group.	<ol style="list-style-type: none"> 1. From the device view, select GigaSMART > Virtual Ports. 2. Click New. 3. Enter vp1 in the Alias field. 4. Select gsgrp1 from the GigaSMART Groups list. 5. Click Save.

Task	Description	UI Steps
6	Create a first level map.	<ol style="list-style-type: none"> 1. Select Maps > Maps > Maps. 2. Click New. 3. Configure the map. <ol style="list-style-type: none"> a. Type map11 in the Alias field. b. Select First Level for Type. c. Select By Rule for Subtype. d. Select the network port 1/1/x1 for the Source. e. Select the virtual port vp1 for the Destination. 6. Add a rule. <ol style="list-style-type: none"> a. Click Add a Rule. b. Select Pass. c. Select IPv4 Protocol and set Value to UDP. d. Select Port Destination and set the port value to 2152 5. Click Save.
7	Create a second level map. The gsrule specifies the traffic to drop, using keywords. Buffered packets and all subsequent packets will be dropped.	<ol style="list-style-type: none"> 1. Click New. 2. Configure the map. <ol style="list-style-type: none"> a. Type map22 in the Alias field. b. Select Second Level for Type. c. Select By Rule for Subtype. d. Select the virtual port vp1 for the Source. e. Select the tool port 1/1/x6 for the Destination. f. Select gsop1 form the GSOP list. 7. Add a rule. <ol style="list-style-type: none"> a. Click Add a Rule. b. Select Drop. c. Select Pattern Match. d. Select regex and enter netflix nflxvideo nflximg Netflix nflxext. e. Set the offset from 0 to 1460 f. Set Protocol to tcp and set Position to 1. 7. Click Save.

Example 2: Buffer ASF, Drop YouTube Traffic

In Example 2, the goal is to drop all YouTube traffic. The YouTube traffic is expected to be identified in the first 7 packets of a session. (Configure the maximum number of packets buffered before the match to 6.) A maximum of 4 million sessions is specified.

Step	Description	Command
1	Configure a GigaSMART group and associate it with GigaSMART engine ports and define the maximum number of sessions, in millions	<ol style="list-style-type: none"> From the device view, select GigaSMART > GigaSMART Groups > GigaSMART Groups. Click New. Type gsgrp1 in the Alias field. Select two engine ports from the Port List field. For example, 1/3/e1 and 1/3/e2 Under Params Resource Buffer, select ASF and set the Buffer Size to 4. Click Save.
2	If needed, reload the GigaSMART line card or module to allocate the resources for buffer ASF.	<p>If you reset the buffer size of an ASF profile in Task 1, go to the Chassis page and select Table View. Under Cards, select the card to reload. From the Actions menu select Shut Down and then Start Up.</p> <p>You can also issue the following CLI commands to reboot the card (the card is in slot 3 in this example):</p> <pre>(config) # card slot 3 down (config) # no card slot 3 down</pre>
3	<p>Create a flow session, specify the buffer count before the match, and enable buffering.</p> <div style="border: 1px solid gray; padding: 5px; margin-top: 10px;"> <p>NOTE: The default protocol is TCP, so it does not need to be specified.</p> </div>	<ol style="list-style-type: none"> From the device view, select GigaSMART > ASF. Click New or select an existing ASF profile then click Edit. Type asf2 in the Alias field if this is a new ASF profile. Enable Buffer. Set Buffer Count before Match to 6. Set the session field to ipv4-5tuple outer Click Save.
4	Configure the combined GigaSMART operation.	<ol style="list-style-type: none"> From the device view, select GigaSMART > GigaSMART Operations (GSOP) > GigaSMART Operations and create two GigaSMART Operations. Click New. Type gsop1 in the Alias field. Select gsgrp1 from the GigaSMART Groups list. Select the operations. <ul style="list-style-type: none"> Adaptive Packet Filtering ASF with asf2 for the ASF profile Click Save.
5	Create a virtual port and associate it with the GigaSMART group.	<ol style="list-style-type: none"> From the device view, select GigaSMART > Virtual Ports. Click New. Enter vp1 in the Alias field. Select gsgrp1 from the GigaSMART Groups list. Click Save.
6	Create a first level map.	<ol style="list-style-type: none"> Select Maps > Maps > Maps.

Step	Description	Command
		<ol style="list-style-type: none"> 2. Click New. 3. Configure the map. <ol style="list-style-type: none"> a. Type map11 in the Alias field. b. Select First Level for Type. c. Select By Rule for Subtype. d. Select the network port 1/1/x1 for the Source. e. Select the virtual port vp1 for the Destination. 6. Add a rule. <ol style="list-style-type: none"> a. Click Add a Rule. b. Select Pass. c. Select IPv4 Version and set Version to v4. 4. Click Save.
7	Create a second level map. The gsrule specifies the traffic to drop, using keywords. Buffered packets and all subsequent packets will be dropped.	<ol style="list-style-type: none"> 1. Click New. 2. Configure the map. <ol style="list-style-type: none"> a. Type map22 in the Alias field. b. Select Second Level for Type. c. Select By Rule for Subtype. d. Select the virtual port vp1 for the Source. e. Select the tool port 1/1/x6 for the Destination. f. Select gsop1 form the GSOP list. 7. Add a rule. <ol style="list-style-type: none"> a. Click Add a Rule. b. Select Drop. c. Select Pattern Match. d. Select regex and enter <code>youtubelytimg yt3.ggpht tubeMogull tmogul.</code> e. Set the offset from 0 to 1460 f. Set Protocol to tcp and set Position to 1. 7. Click Save.

Example 3: Buffer ASF, Drop Windows Update Traffic

In Example 3, the goal is to drop all Windows update traffic. The Windows update traffic is expected to be identified on the HTTP request packet of a session. A maximum of 2 million sessions is specified.

Task	Description	UI Steps
1	Configure a GigaSMART group and associate it with GigaSMART engine	<ol style="list-style-type: none"> 1. From the device view, select GigaSMART > GigaSMART Groups > GigaSMART Groups.

Task	Description	UI Steps
	ports and define the maximum number of sessions, in millions.	<ol style="list-style-type: none"> Click New. Type gsgrp1 in the Alias field. Select two engine ports from the Port List field. For example, 1/3/e1 and 1/3/e2 Under Params Resource Buffer, select ASF and set the Buffer Size to 2. Click Save.
2	If needed, reload the GigaSMART line card or module to allocate the resources for buffer ASF.	<p>If you reset the buffer size of an ASF profile in Task 1, go to the Chassis page and select Table View. Under Cards, select the card to reload. From the Actions menu select Shut Down and then Start Up. You can also issue the following CLI commands to reboot the card (the card is in slot 3 in this example):</p> <p>(config) # card slot 3 down (config) # no card slot 3 down</p>
3	<p>Create a flow session, specify the buffer count before the match, and enable buffering.</p> <div style="border: 1px solid gray; padding: 5px; margin-top: 10px;"> <p>NOTE: The default protocol is TCP, so it does not need to be specified.</p> </div>	<ol style="list-style-type: none"> From the device view, select GigaSMART > ASF. Click New or select an existing ASF profile then click Edit. Type asf2 in the Alias field if this is a new ASF profile. Enable Buffer. Set Buffer Count before Match to 3. Set the session field to ipv4-5tuple outer Click Save.
4	Configure the combined GigaSMART operation.	<ol style="list-style-type: none"> From the device view, select GigaSMART > GigaSMART Operations (GSOP) > GigaSMART Operations and create two GigaSMART Operations. Click New. Type gsop1 in the Alias field. Select gsgrp1 from the GigaSMART Groups list. Select the operations. <ul style="list-style-type: none"> Adaptive Packet Filtering ASF with asf2 for the ASF profile Click Save.
5	Create a virtual port and associate it with the GigaSMART group.	<ol style="list-style-type: none"> From the device view, select GigaSMART > Virtual Ports. Click New. Enter vp1 in the Alias field. Select gsgrp1 from the GigaSMART Groups list. Click Save.
6	Create a first level map.	<ol style="list-style-type: none"> Select Maps > Maps > Maps. Click New. Configure the map.

Task	Description	UI Steps
		<ol style="list-style-type: none"> a. Type map11 in the Alias field. b. Select First Level for Type. c. Select By Rule for Subtype. d. Select the network port 1/1/x1 for the Source. e. Select the virtual port vp1 for the Destination. <ol style="list-style-type: none"> 6. Add a rule. <ol style="list-style-type: none"> a. Click Add a Rule. b. Select Pass. c. Select IPv4 Version and set Version to v4. <ol style="list-style-type: none"> 4. Click Save.
7	Create a second level map. The gsrule specifies the traffic to drop. Buffered packets and all subsequent packets will be dropped.	<ol style="list-style-type: none"> 1. Click New. 2. Configure the map. <ol style="list-style-type: none"> a. Type map22 in the Alias field. b. Select Second Level for Type. c. Select By Rule for Subtype. d. Select the virtual port vp1 for the Source. e. Select the tool port 1/1/x6 for the Destination. f. Select gso1 from the GSOP list. 7. Add a rule. <ol style="list-style-type: none"> a. Click Add a Rule. b. Select Drop. c. Select Pattern Match. d. Select regex and enter msdownload/update/software. e. Set the offset from 0 to 1460 f. Set Protocol to tcp and set Position to 1. 7. Click Save.

Example 4: Buffer ASF, Forward VNC Traffic

In Example 4, the goal is to forward VNC traffic from network port 1/1/x1 to tool port 1/1/x6. All packets belonging to the TCP connection need to be sent to the tool port. The first data packet after the TCP handshake is expected to contain the VNC pattern match. A maximum of 2 million sessions is specified.

Task	Description	UI Steps
1	Configure a GigaSMART group and associate it with GigaSMART engine ports and define the maximum number of sessions, in millions.	<ol style="list-style-type: none"> 1. From the device view, select GigaSMART > GigaSMART Groups > GigaSMART Groups. 2. Click New. 3. Type gsg1 in the Alias field.

Task	Description	UI Steps
		<ol style="list-style-type: none"> 4. Select two engine ports from the Port List field. For example, 1/3/e1 and 1/3/e2 5. Under Params Resource Buffer, select ASF and set the Buffer Size to 2. 6. Click Save.
2	If needed, reload the GigaSMART line card or module to allocate the resources for buffer ASF.	<p>If you reset the buffer size of an ASF profile in Task 1, go to the Chassis page and select Table View. Under Cards, select the card to reload. From the Actions menu select Shut Down and then Start Up. You can also issue the following CLI commands to reboot the card (the card is in slot 3 in this example):</p> <p>(config) # card slot 3 down (config) # no card slot 3 down</p>
3	<p>Create a flow session, specify the buffer count before the match, and enable buffering.</p> <div style="border: 1px solid black; padding: 5px; margin-top: 10px;"> <p>NOTE: The default protocol is TCP, so it does not need to be specified.</p> </div>	<ol style="list-style-type: none"> 1. From the device view, select GigaSMART > Application Session Filtering. 2. Click New or select an existing ASF profile then click Edit. 3. Type asf1 in the Alias field if this is a new ASF profile. 4. Enable Buffer. 5. Set Buffer Count before Match to 3. 6. Set the session field to ipv4-5tuple outer 7. Click Save.
4	Configure the combined GigaSMART operation.	<ol style="list-style-type: none"> 1. From the device view, select GigaSMART > GigaSMART Operations (GSOP) > GigaSMART Operation and create two GigaSMART Operations. 2. Click New. 3. Type gsop1 in the Alias field. 4. Select gsgrp1 from the GigaSMART Groups list. 5. Select the operations. <ul style="list-style-type: none"> • Adaptive Packet Filtering • ASF with asf1 for the ASF profile 6. Click Save.
5	Create a virtual port and associate it with the GigaSMART group.	<ol style="list-style-type: none"> 1. From the device view, select GigaSMART > Virtual Ports. 2. Click New. 3. Enter vp1 in the Alias field. 4. Select gsgrp1 from the GigaSMART Groups list. 5. Click Save.
6	Create a first level map.	<ol style="list-style-type: none"> 1. Select Maps > Maps > Maps. 2. Click New. 3. Configure the map. <ol style="list-style-type: none"> a. Type map11 in the Alias field.

Task	Description	UI Steps
		<ul style="list-style-type: none"> b. Select First Level for Type. c. Select By Rule for Subtype. d. Select the network port 1/1/x1 for the Source. e. Select the virtual port vp1 for the Destination. <p>6. Add a rule.</p> <ul style="list-style-type: none"> a. Click Add a Rule. b. Select Pass. c. Select IPv4 Version and set Version to v4. <p>4. Click Save.</p>
7	Create a second level map. The gsrule specifies the traffic to pass. Buffered packets and all subsequent packets will be passed.	<p>1. Click New.</p> <p>2. Configure the map.</p> <ul style="list-style-type: none"> a. Type map22 in the Alias field. b. Select Second Level for Type. c. Select By Rule for Subtype. d. Select the virtual port vp1 for the Source. e. Select the tool port 1/1/x6 for the Destination. f. Select gsop1 from the GigaSMART Operations (GSOP) list. <p>7. Add a rule.</p> <ul style="list-style-type: none"> a. Click Add a Rule. b. Select Pass. c. Select Pattern Match. d. Select regex and enter <code>^rfb 00[1-9]\.00[0-9]\x0a\$</code>. e. Set Protocol to tcp and set Position to 1. <p>6. Click Save.</p>

Example 5: Buffer ASF, Forward HTTPS Traffic on Non-Standard Port

In Example 5, the goal is to forward HTTPS traffic that uses a non-standard Layer 4 port. All packets belonging to the TCP connection need to be sent to the tool port. A maximum of 5 million sessions is specified.

Task	Description	UI Steps
1	Configure a GigaSMART group and associate it with GigaSMART engine ports and define the maximum number of sessions, in millions.	<ul style="list-style-type: none"> 1. GigaSMART > GigaSMART Groups > GigaSMART Groups. 2. Click New. 3. Type gsgrp1 in the Alias field. 4. Select two engine ports from the Port List field. For example, 1/3/e1 and 1/3/e2 5. Under Params Resource Buffer, select ASF and set the Buffer Size to 2.

Task	Description	UI Steps
		<ol style="list-style-type: none"> Click Save.
2	If needed, reload the GigaSMART line card or module to allocate the resources for buffer ASF.	<p>If you reset the buffer size of an ASF profile in Task 1, go to the Chassis page and select Table View. Select the card in the table. From the Actions menu select Shut Down and then Start Up.</p> <p>You can also issue the following commands to reboot the card (the card is in slot 3 in this example):</p> <p>(config) # card slot 3 down</p> <p>(config) # no card slot 3 down</p>
3	<p>Create a flow session, specify the buffer count before the match, and enable buffering.</p> <div style="border: 1px solid gray; padding: 5px; margin-top: 10px;"> <p>NOTE: The default protocol is TCP, so it does not need to be specified.</p> </div>	<ol style="list-style-type: none"> From the device view, select GigaSMART > ASF. Click New or select an existing ASF profile then click Edit. Type asf2 in the Alias field if this is a new ASF profile. Enable Buffer. Set Buffer Count before Match to 3. Set the session field to ipv4-5tuple outer Click Save.
4	Configure the combined GigaSMART operation.	<ol style="list-style-type: none"> From the device view, select GigaSMART > GigaSMART Operations (GSOP) > GigaSMART Operations and create two GigaSMART Operations. Click New. Type gsop1 in the Alias field. Select gsgrp1 from the GigaSMART Groups list. Select the operations. <ul style="list-style-type: none"> APF ASF with asf2 for the ASF profile Click Save.
5	Create a virtual port and associate it with the GigaSMART group.	<ol style="list-style-type: none"> From the device view, select GigaSMART > Virtual Ports. Click New. Enter vp1 in the Alias field. Select gsgrp1 from the GigaSMART Groups list. Click Save.
6	Create a first level map.	<ol style="list-style-type: none"> Select Maps > Maps > Maps. Click New. Configure the map. <ol style="list-style-type: none"> Type map11 in the Alias field. Select First Level for Type. Select By Rule for Subtype. Select the network port 1/1/x1 for the Source. Select the virtual port vp1 for the Destination.

Task	Description	UI Steps
		<ol style="list-style-type: none"> 6. Add a rule. <ol style="list-style-type: none"> a. Click Add a Rule. b. Select Pass. c. Select IPv4 Version and set Version to v4. 4. Click Save.
7	Create a second level map. The gsrule specifies the traffic to pass. The RegEx expression identifies the traffic as SSL. Buffered packets and all subsequent packets will be passed.	<ol style="list-style-type: none"> 1. Click New. 2. Configure the map. <ol style="list-style-type: none"> a. Type map22 in the Alias field. b. Select Second Level for Type. c. Select By Rule for Subtype. d. Select the virtual port vp1 for the Source. e. Select the tool port 1/1/x6 for the Destination. f. Select gsop1 form the GSOP list. 7. Add a rule. <ol style="list-style-type: none"> a. Click Add a Rule. b. Select Pass. c. Select Pattern Match. d. Select regex and enter x16\x03.{3}\x01. e. Set Protocol to tcp and set Position to 1. 6. Click Save.

Display ASF Statistics

To display ASF statistics on the GigaSMART operation, select **GigaSMART > Statistics**.

Refer to [ASF Statistics Definitions](#) for descriptions of these statistics as well as to [GigaSMART Operations Statistics Definitions](#).

Subscriber Intelligence

Designed to meet the needs of service providers, these GigaSMART operations provide complete network and subscriber visibility to increase the efficiency of network monitoring, security, and customer experience tools.

Subscriber Intelligence	
GTP Correlation	<ul style="list-style-type: none"> • GigaSMART GTP Correlation • GigaSMART GTP Whitelisting and GTP Flow Sampling

	<ul style="list-style-type: none"> • Display Flow Ops Reports • GTP Overlap Flow Sampling Maps • GTP Scaling • GTP Stateful Session Recovery
Diameter S6a Correlation	<ul style="list-style-type: none"> • GigaSMART Diameter S6a Correlation
SIP/RTP Correlation	<ul style="list-style-type: none"> • GigaSMART SIP/RTP Correlation
FlowVUE	<ul style="list-style-type: none"> • GigaSMART FlowVUE

GigaSMART GTP Correlation

Required License: GTP Filtering & Correlation

The GigaSMART GTP application correlates traffic based on mobile subscriber IDs in the packet data networks of service providers. It provides a mechanism to filter and forward session traffic for subscribers to tools. GTP correlation assists mobile carriers in debugging and analyzing GTP traffic in their 3G/4G networks.

GPRS Tunneling Protocol (GTP) is an IP/UDP-based protocol that carries mobile data across service provider networks. The protocol is used in General Packet Radio Service (GPRS) networks such as: Global System for Mobile Communications (GSM), Universal Mobile Telecommunications System (UMTS), and Long Term Evolution (LTE). The protocol encapsulates user data that passes through the core network and carries subscriber-specific signaling traffic.

GTP includes both control plane (GTP-c) and user-data plane (GTP-u) traffic. To gain an accurate view into the subscriber's session, GTP tunnels are used to correlate the subscriber-specific control plane and user-data plane traffic. A GTP session is the minimum unit of GTP correlation consisting of one control and multiple user tunnels. All GTP traffic belonging to the same session is forwarded to the same tool port.

Using GTP correlation, you can filter, replicate, and forward specific subscriber sessions to specific tools by correlating the subscriber IDs that are exchanged as part of the control sessions to the corresponding tunnel IDs (TEIDs) that are part of the user-data plane traffic.

GTP correlation provides the following:

- stateful filtering based on subscriber IDs (IMSI, IMEI, and MSISDN)
- stateful filtering based on GTP version or EPC interface
- stateful correlation of GTP-c with GTP-u traffic

- correlation of subscriber ID with corresponding tunnel ID
- forwarding of the subscriber-specific control and user-data plane traffic to a tool or group of tools
- supports a maximum of 5 million GTP subscriber sessions for GigaVUE-HC2 nodes, whereas, it supports 12 million GTP subscriber sessions for GigaVUE-HC3 nodes
- combine with GigaSMART Load Balancing to load balance GTP traffic to a set of tool ports. For information on GTP load balancing, refer to stateful load balancing in the section [GigaSMART Load Balancing](#). For examples of GTP load balancing, refer to [Configure GTP Correlation Examples](#). Starting in software version 4.6, GTP load balancing in a cluster is supported for GTP flow filtering. For an example of GTP load balancing in a cluster, refer to [GTP Whitelisting and GTP Flow Sampling Examples](#).

Starting in software version 4.5, a GigaSMART group (gsgroup) associated with GTP applications can have multiple GigaSMART engine port members (e ports), up to four, forming an engine group. Refer to [GTP Scaling](#).

Filtering on Subscriber IDs and Version

GTP stateful filtering supports filtering of GTP sessions based on the following subscriber IDs:

Component	Description
imsi	The International Mobile Subscriber Identity (IMSI) is a number that identifies a subscriber of a cellular network. It is a unique identification associated with all cellular networks. An IMSI is usually a 15 digit number, associated with GSM, UMTS, and LTE network mobile phone users.
imei	The International Mobile Station Equipment Identity (IMEI) is a number, usually unique, that identifies 3rd Generation Partnership Project (3GPP), for example, GPRS, LTE, as well as Integrated Digital Enhanced Network (iDEN) mobile phones, and some satellite phones. The IMEI identifies the device, but has no permanent relationship to the subscriber. Instead, the subscriber is identified by transmission of an IMSI number, stored on a SIM card.
msisdn	The Mobile Station International Subscriber Directory Number (MSISDN) is a unique number that identifies subscribers in a GSM or UMTS mobile network. This numbering plan is defined in the ITU-T recommendation E.164. The maximum length of an MSISDN is 15 digits.

In addition to filtering on subscriber IDs, you can optionally filter on GTP version (v1 or v2) or Evolved Packet Core (EPC) interface. Filtering on the EPC interface allows traffic to be segmented for a given interface.

The supported interfaces for EPC filtering are as follows:

- Gn/Gp

- S11U
- S11/S1-U
- S5/S8
- S10
- S2B

When filtering on EPC interface, you do not also need to specify version, as the version is implied.

To create maps using GTP, specify a **Second Level Flow Sample** map and select **GTP** for the rule. When adding a map rule, you can specify the following:

- subscriber IDs (IMSI, IMEI, or MSISDN)
- number of digits. The maximum number of digits for the IMSI or MSISDN value is 15. The maximum number of digits for the IMEI value is 16. To specify the prefix for IMSI, IMEI, or MSISDN, you can use a wild card character or a digit string followed by a wild card character.
- map comment to label the purpose of a rule or the type of traffic covered by a rule
- GTP version 1 or version 2 (refer to [Figure 357: GTP Version](#)) or EPC interface Gn/GP, S5/S8, or S10, S2B, or S11/S1U (refer to [Figure 358: GTP EPC Interface](#))

NOTE: In a map, version and EPC interface cannot be specified in the same flowrule, but they can be specified in different flowrules.

NOTE: The maximum number of GTP flowrules is 32 per map.

For examples of filtering on GTP version, refer to [Configure GTP Correlation Examples](#).

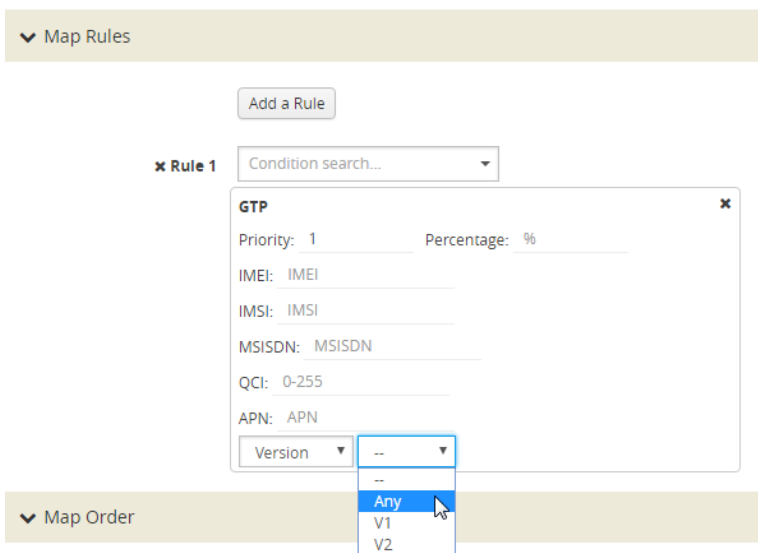


Figure 357: GTP Version

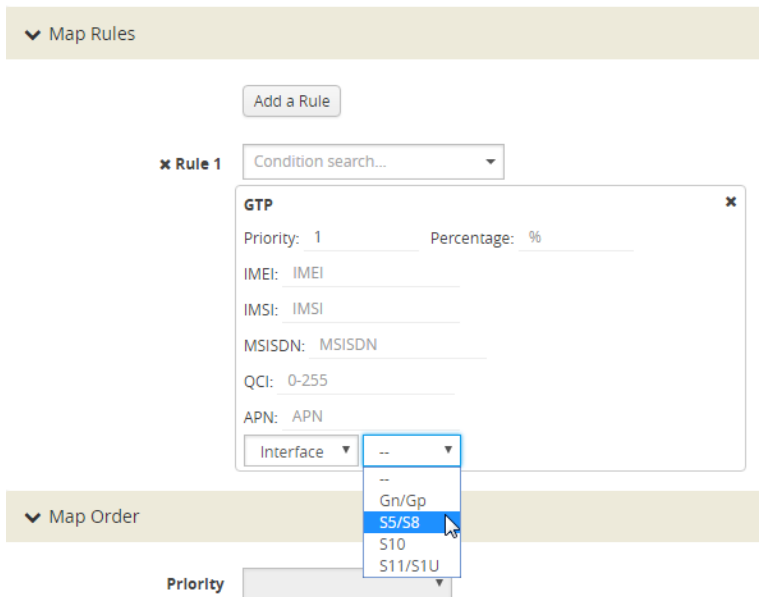
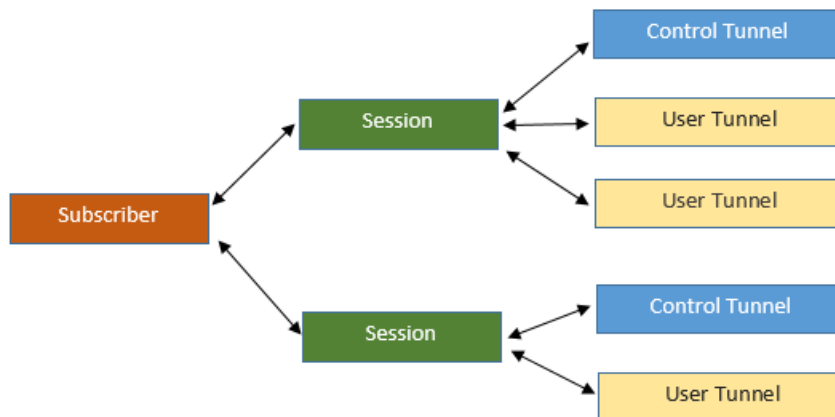


Figure 358: GTP EPC Interface

Session Correlation

Each GTP session has one control tunnel and one or more user tunnels. All the tunnels are correlated together into a session. Packets belonging to the same session will be forwarded to the same tool port. Refer to the following figure.



In a second level map, the following can be specified:

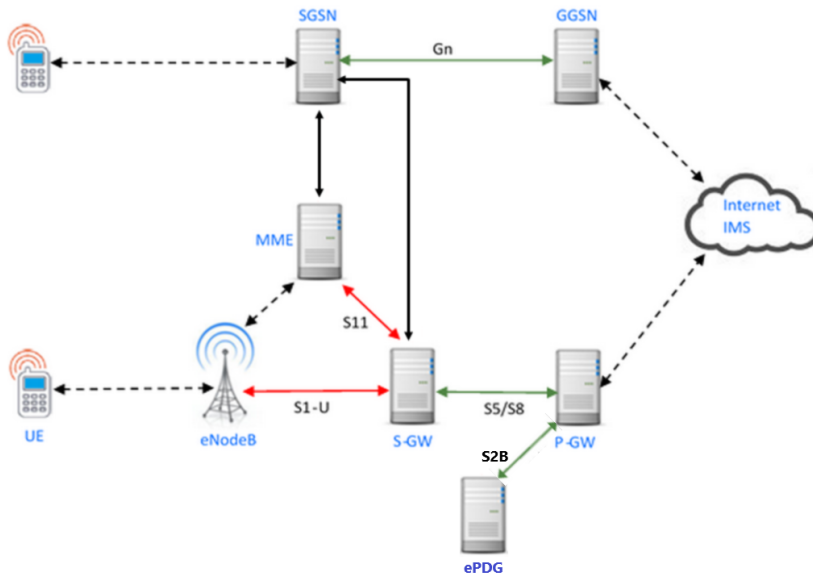
- one tool port—packets from one subscriber (same subscriber ID), from one or more GTP sessions, will be forwarded to the same tool port.
- multiple tool ports—packets from one subscriber (same subscriber ID), from multiple GTP sessions will be correlated and forwarded to same tool port. Using load balancing, GTP traffic that matches the same map but belongs to different subscribers can be load balanced to multiple tool ports.

Supported Interfaces

GTP is used at multiple interfaces by multiple devices in the core network. GTP stateful correlation is implemented for the following interfaces:

- Gn/Gp (for GPRS). The Gn interface is between SGSN-GGSN only.
- S5/S8 (for LTE)
- S1-U, S11U and S11 (for LTE)
- S10 (for S1-based mobility) Refer to [Conditional S10 Support](#)
- S2B

Support for interfaces for both GPRS and LTE networks includes the handovers between the different networks. Refer to the following figure.



For LTE networks, the following GTP traffic will be correlated to the specific mobile subscriber and routed to the same tool port:

- GTP-c traffic on the S11 interface between MME and S-GW
- GTP-u traffic on the S11u interface between MME and S-GW
- GTP-u traffic on the S1u interface between eNodeB and S-GW
- GTP-c traffic on the S10 interface between MMEs
- GTP-c traffic on the S5/S8 interface between S-GW and P-GW
- GTP-u traffic on the S5u interface between S-GW and P-GW
- GTP-c traffic on the S2b interface between P-GW and ePDG
- GTP-u traffic on the S2b-U interface between P-GW and ePDG

In order to correlate GTP-c and GTP-u traffic running on different interfaces, you must tap into the correct interfaces, as follows:

- Gn/Gp—one interface runs both GTP-c and GTP-u
- S5/S8—one interface runs both GTP-c and GTP-u
- S1u, S11u, and S11—these three interfaces have to be tapped at the same time to get both GTP-c and GTP-u to perform the correct correlation.
- S2b-C and S2b-U interfaces needs to be tapped to get GTP-c and GTP-u traffic for correlation.

For examples of filtering on GTP interface types Gn/Gp, S5/S8, S1 and S11, refer to [Configure GTP Correlation Examples](#).

Conditional S10 Support

The following table outlines support for the S10 interface. In the table, No means not supported, Conditional means there is limited support of the S10 interface.

S10	Support
Forward Relocation Request/Resp	Conditional; IMSI must be present in Forward Relocation Request
Forward Relocation Complete Notification/Ack	Conditional; IMSI must be present in Forward Relocation Request for Forward Relocation Complete Notification/Ack to be supported
Context Request/Response and Ac	Conditional; IMSI must be present
Identification Request/Response	No
Forward Access Context Notification/Ack	No
Relocation Cancel Request/Response	No
Configuration Transfer Tunnel	No

GigaSMART 3GPP CUPS Support

CUPS stands for Control and User Plane Separation of Evolved Packet Core nodes. 3GPP CUPS enhances the Evolved Packet Core nodes by introducing the following three new interfaces between the control plane and user plane functions of the S-GW, P-GW and TDF, respectively:

- SXa
- SXb
- SXc

Figure 359: 3GPP CUPS Network topology illustrates 3GPP CUPS Network topology

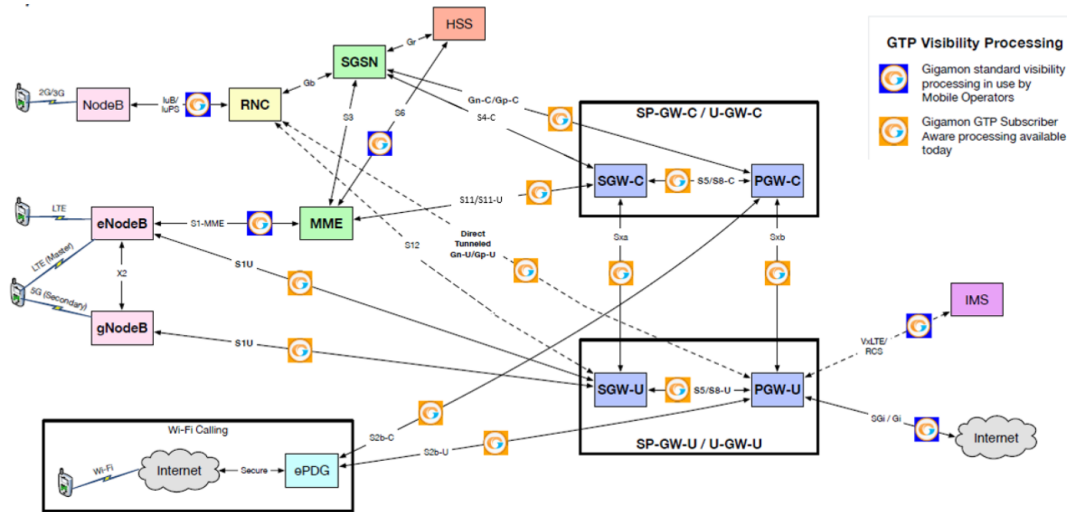


Figure 359: 3GPP CUPS Network topology

The advantages of 3GPP CUPS include the following:

- Increased flow of data traffic.
- Reduced latency.
- Independent User Plane and Control Plane scaling.

Starting in software version 5.6, GigaSMART GTP correlation leverages the SXa and SXb interfaces of the 3GPP CUPS architecture to receive additional traffic that is used to include the GTP session with the Packet Forwarding Control Protocol (PFCP) session. With this enhancement, control traffic and user traffic are processed at the following nodes (engines):

- Control Processing Node (CPN) - to process control traffic
- User Processing Node (UPN) - to process user traffic

The CPN and UPN communicate with each other.

The following topology diagram explains about the communication between CPN and UPN:

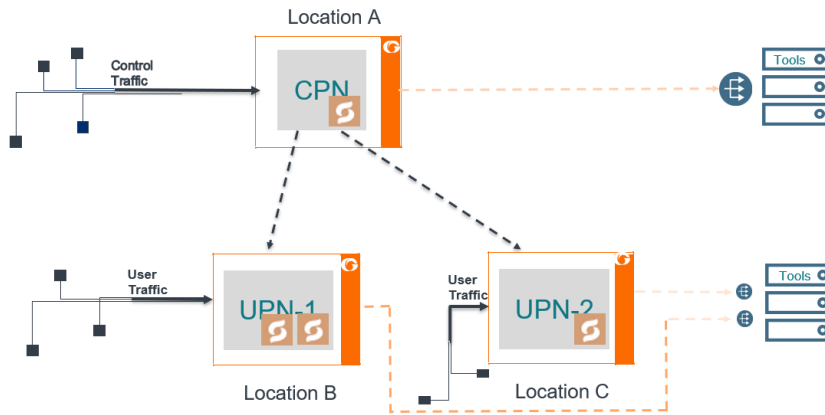


Figure 360: Topology diagram of CPN and UPN Connections

The user traffic is processed in UPN-1 and UPN-2 present in *Location B* and *Location C*, respectively. The control traffic is processed at CPN present in *Location A*, and few control parameters are sent to UPN-1 and UPN-2. *Location A* handles control traffic corresponding to the user traffic of *Location B* and *Location C*. The CPN and UPN can be present at the same location or at a different location.

When the GigaSMART engine in the CPN receives the control traffic, it generates a session table with information such as IMSI, MSISDN, IMEI, QCI, APN values and performs whitelisting, flow sampling and load balancing. UPN supports engine grouping, whereas CPN do not support engine grouping.

A Subscriber Flow Forwarding Protocol (SFFP) profile is created from CPN IP interface to transfer the appropriate control parameters to the corresponding UPN IP interface. The apps exporter at the CPN IP interface instructs the control processing node about the number of user groups it supports, and the source and destination port to route the packets.

The apps listener at the UPN IP interface receives the control parameters from the CPN to UPN interface and helps the UPN to generate a session table based on the Transport Agent (TA) packet information received at the IP interface. IP interface is a communication channel between the CPN and the UPN. The session table performs whitelisting, flow sampling and load balancing at the UPN. UPN correlates the user traffic by using the populated session table.

Limitations

- Engine Grouping on CPN is not supported.
- SXa, SXb packets are broadcasted to all the tool ports.
- A loop back IP connection with a router is required in-between the CPN and UPN if they are present within the same chassis.

The following table summarizes the required tasks for configuring the GigaSMART 3GPP CUPS:

S.No	Task	Refer to...
1.	Configure an IP interface to send and receive the Gigamon Transport Agent packets.	IP Interfaces
2.	Configure the apps listener to configure the TCP connection at the IP interface in the UPN.	Configure Apps Listener
3.	Configure the apps exporter to configure the TCP connection at the IP interface in the CPN.	Configure Apps Exporter
4.	Configure the SFFP Profile. NOTE: You can configure SFFP profile using CLI commands and Ansible Playbook.	To configure the SFFP profiles refer to the command SFFP profile in GigaVUE-OS-CLI Reference Guide 5.8.00 and GigaVUE-FM Automation with Ansible Playbook.
5.	In the first level map configuration create a new rule to pass SXa, SXb packets through port number 8805.	
6.	Configure a node role for the control and user node, and attach a SFFP-profile to the CPN node in the GigaSMART engine.	To associate the SFFP profile to the CPN node refer to the command SFFP profile in GigaVUE-OS-CLI Reference Guide 5.8.00.

Configure Apps Listener

To configure the apps listener, do the following:

1. Select **Physical Nodes** from the Navigation pane.
2. Select the device on which you want to configure an apps listener by clicking the Cluster ID of the device.
3. Select **GigaSMART > TCP/IP Host > Listener**.
4. Click **New**.
5. On the **Listener** page, do the following:
 - a. In the **Alias** field, enter the name of the listener.
 - b. In the **Application Type**, select GTP CUPS from the drop down list.
 - c. In the **GigaSMART Group**, select a GigaSMART group for which you want to associate the **Listener**.
 - d. In the **L3 Protocol** drop down list, select a Layer 3 protocol.
 - e. In the **L4 Protocol** drop down list, select a Layer 4 protocol.
 - f. In the **L4 Port** field, enter a list of port numbers through which the traffic is to be received. The value must be between 1 and 65535.

- g. In the **TTL** field, enter the time-to-live (TTL) value. The value must be between 1 and 255.
- h. In the **DSCP** field, enter the DSCP value. The value must be between 0 and 63.
- i. Select **OK**.

To view the Apps Listener statistics, go to **GigaSMART > TCP/IP Host > Listener Statistics**.

Configure Apps Exporter

To configure the apps exporter, do the following:

1. Select **Physical Nodes** from the Navigation pane.
2. Select the device on which you want to configure a SFFP profile by clicking the Cluster ID of the device.
3. Select **GigaSMART > TCP/IP Host > Exporter**.
4. Click **New**.
5. On the **Exporter** page, do the following:
 - a. In the **Alias** field, enter the name of the exporter.
 - b. In the **Application Type**, select GTP CUPS from the drop down list.
 - c. In the **GigaSMART Group**, select a GigaSMART group for which you want to associate the **Exporter**.
 - d. In the **Source** field do the following:
 - Select an IP interface through which you want to export the information from CPN.
 - In the L4 Port, enter the port number through which the traffic is to be transferred. The value must be between 1 and 65535.
6. In the **Destination** field do the following:
 - Select a Layer 3 Protocol.
 - Enter the time-to-live (TTL) value. The value must be between 1 and 255.
 - Enter the DSCP value. The value must be between 0 and 63.
 - Select a Layer 4 Protocol and enter their corresponding port value. The L4 port value must be between 1 and 65535.
 - Select **OK**.

To view the Apps Exporter statistics, go to **GigaSMART > TCP/IP Host > App Exporter**.

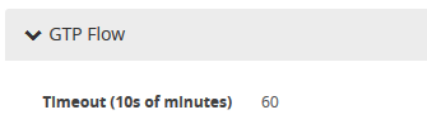
GTP Session Timeout

To access GigaSMART within GigaVUE-FM, access a device that has been added to GigaVUE-FM from the GigaVUE-FM interface. GigaSMART appears in the navigation pane of the device view on supported devices. Refer to [Access GigaSMART from GigaVUE-FM](#) for details.

In prior software versions, the complete GTP session timeout was eight hours. Starting with software version 4.2, the GTP session timeout is configurable, with eight hours as the default.

To configure the GTP session timeout, do the following:

1. From the device view, select **GigaSMART > GigaSMART Groups > GigaSMART Groups**.
2. Click **New** to create a new GigaSMART Group or **Edit** to modify an existing one.
3. Under GigaSMART Parameters, go to GTP Flow.
4. Enter the timeout in the **Timeout** field. The following figure shows an example where the timeout value is set to 60.



The screenshot shows a configuration interface for GigaSMART. At the top, there is a dropdown menu labeled "GTP Flow". Below it, there is a field labeled "Timeout (10s of minutes)" with the value "60" entered. The field is a simple text input with a horizontal line underneath the text.

5. Click **Save**.

The GTP session timeout disconnects a GTP session if it has been inactive for the timeout value. The timeout can be configured as an integer from 1 to 6000, in increments of 10 minutes. The default value is 48, which is 480 minutes, which is 8 hours.

Priorities for Flow Rules and Maps

One virtual port can have multiple maps, and for each map, you can add multiple flow rules with different filtering attributes. The priorities for flow rules are as follows:

- a rule with a drop action has a higher priority than a rule with a pass action
- for the same pass or drop action, the priorities are IMSI, IMEI, or MSISDN in descending order

In a GTP session, if one IMSI, IMEI, or MSISDN rule is matched, the map is matched. For example, if any one of the following matches any rule shown in the following figure, map1 (which is a Second Level Flow Filter map) is matched:

Map Rules

Add a Rule

Rule 1 Pass Drop

GTP IMSI
1234* Version Any

Rule 2 Pass Drop

GTP IMEI
467* Version Any

Rule 3 Pass Drop

GTP MSISDN
32332* Version Any

In addition, in one map, all drop rules are matched first and all pass rules are matched next.

For example, in a GTP session, if an IMSI matches the first rule in map1 and an IMEI matches the second rule in map1, because the drop rule has higher priority, the packet will be dropped:

Map Rules

Add a Rule

Rule 1 Pass Drop

GTP IMSI
1234* Version Any

Rule 2 Pass Drop

GTP IMEI
467* Version Any

If multiple maps are matched, the map with the highest priority will be considered for further processing. For example, the [Figure 361: Rule in Map1](#) shows the rule for map1 while the rule [Figure 430: NetFlow Generation Gigamon Solution](#) shows the rule for map2. In a GTP session, if an IMSI matches the first rule in map1 and an IMEI matches the first rule in map2, because map1 has higher priority, the packet will be passed.

Map Rules

Add a Rule

Rule 1 Pass Drop

GTP IMSI
1234* Version Any

Figure 361: Rule in Map1

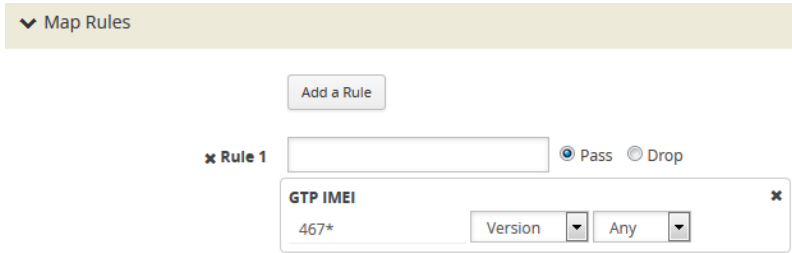


Figure 362: Rule in Map2

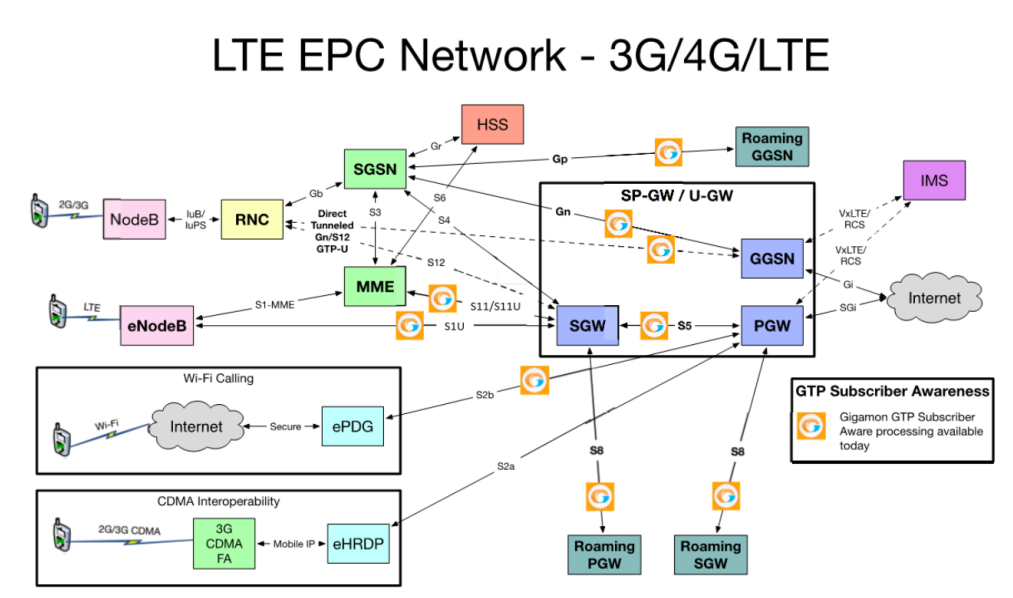
Configure GTP Correlation Examples

The following sections provide examples of GTP correlation and GTP load balancing. Refer to the following examples:

- Example 1: Identifying High-Value and/or Roaming Subscribers Based on IMSIs
- Example 2: Identifying GTP Versions
- Example 3: Same Subscriber, Filter on Different Versions
- Example 4: Same Subscriber, Filter on Different Interfaces
- Example 5: EPC Filtering
- Example 6: EPC Filtering

Example 1: Identifying High-Value and/or Roaming Subscribers Based on IMSIs

Use GTP correlation to identify high value subscribers based on an IMSI or group of IMSIs. GTP correlation keeps track of the IMSIs that you are interested in monitoring. It correlates them to the corresponding data/user-plane sessions for the subscriber and/or group of subscribers. Filtering on subscriber ID (IMSI) limits the amount of traffic that is sent to monitoring tools.



In Example 1, filter rules are configured to identify and forward all the traffic related to subscribers identified by an IMSI prefix. All traffic specific to the filtered IMSIs 2222222222223*, including GTP-c and GTP-u, is forwarded to a monitoring tool. A shared collector is configured to which traffic not matching the filters is sent.

To access GigaSMART within GigaVUE-FM, access a device that has been added to GigaVUE-FM from the GigaVUE-FM interface. GigaSMART appears in the navigation pane of the device view on supported devices. Refer to [Access GigaSMART from GigaVUE-FM](#) for details.

Task	Description	UI Steps
1	Configure one network and two tool type of ports.	<ol style="list-style-type: none"> 1. Select Ports > Ports > All Ports. 2. Click Quick Port Editor. 3. In the Quick View Editor set one port to Network and two ports to Tool. 4. Select Enable on each port. 5. Click OK. 6. Close the Quick Port Editor.
2	Configure a GigaSMART group and associate it with a GigaSMART engine port.	<ol style="list-style-type: none"> 1. From the device view, select GigaSMART > GigaSMART Groups > GigaSMART Groups. 2. Click New. 3. Type a name for the GigaSMART Group in the Alias field. 4. Click in the Port List field and select an engine port. 5. Under GTP Flow set the Timeout. The default is value is 48, which is 480 minutes. 6. Click Save.
3	Configure the GigaSMART operation and assign it to the GigaSMART group to enable GTP correlation.	<ol style="list-style-type: none"> 1. From the device view, select GigaSMART > GigaSMART Operations (GSOP > GigaSMART Operation. 2. Type a name for the GigaSMART Group in the Alias field. 3. Click in the GigaSMART Operations (GSOP) field and select Flow Filtering. 4. Click OK.
4	Configure a virtual port and assign it to the same GigaSMART group.	<ol style="list-style-type: none"> 1. From the device view, select GigaSMART > Virtual Ports. 2. Click New. 3. Type a name for the virtual port in the Alias field. 4. Click in the GigaSMART Groups field, and select the GigaSMART Group created in Task 2. 5. Click OK.

Task	Description	UI Steps
5	<p>Create a first level map that directs GTP traffic from physical network port/s to the virtual port you created in the previous step.</p> <div data-bbox="272 426 716 512" style="border: 1px solid #ccc; padding: 5px;"> <p>NOTE: In the rules, 2123 is GTP-c traffic and 2152 is GTP-u traffic.</p> </div>	<ol style="list-style-type: none"> 1. Select Maps > Maps > Maps 2. Click New. 3. Configure the map. <ul style="list-style-type: none"> • Enter an alias • Select First Level for Type • Select By Rule for Subtype • Select a network port for the Source • Select the virtual port configured in Task 4 for the Destination 4. Create Rule 1. <ol style="list-style-type: none"> a. Click Add a Rule b. Select Pass. c. Select Bi Directional. d. Select Port Source e. Set the source to 2123 6. Create Rule 2. <ol style="list-style-type: none"> a. Click Add Rule b. Select Pass. c. Select Bi Directional d. Select Port Source e. Set the source to 2153 6. Create Rule 3. <ol style="list-style-type: none"> a. Click Add Rule b. Select Pass. c. Select IPv4 Fragmentation d. Set Value to allFragNoFirst 5. Click Save.
6	<p>Create a second level map that takes traffic from the virtual port, applies the GigaSMART operation, matches IMSIs specified by the flow rule, and sends matching traffic to physical tool ports.</p>	<ol style="list-style-type: none"> 1. Select Maps > Maps > Maps 2. Click New. 3. Configure the map. <ul style="list-style-type: none"> • Enter an alias • Select Second Level for Type • Select Flow Filter for Subtype • Select a the virtual port configured in Task for the Source

Task	Description	UI Steps
		<ul style="list-style-type: none"> • Select the a tool port configured in Task 1 for the Destination • Select the GigaSMART Operation created in Task 3 from the GSOP list. <ol style="list-style-type: none"> 4. Create a rule. <ol style="list-style-type: none"> a. Click Add a Rule. b. Select Pass. c. Select GTP IMSI. d. Enter 22222222222223* in the IMSI field. 5. Click Save.
7	Add a shared collector for any unmatched data and send it to the second tool port.	<ol style="list-style-type: none"> 1. Select Maps > Maps > Maps 2. Click New. 3. Configure the map. <ul style="list-style-type: none"> • Enter an alias • Select Second Level for Type • Select Collector for Subtype • Select a the virtual port configured in Task for the Source • Select the second tool port configured in Task 1 for the Destination 4. Click Save.
8	Display the configuration for Example 1.	<p>To display the configuration for the GigaSMART Group:</p> <ol style="list-style-type: none"> 1. From the device view, select GigaSMART > GigaSMART Groups. 2. Click on the alias for the GigaSMART Group to display the Quick View. <p>To display the configuration for the GigaSMART Operation:</p> <ol style="list-style-type: none"> 1. From the device view, select GigaSMART > GigaSMART Operations (GSOP) > GigaSMART Operation. 2. Click on the alias for the GigaSMART Operation to display the Quick View. <p>To display the configuration for the maps:</p> <ol style="list-style-type: none"> 1. Select Maps > Maps > Maps. 2. Click on a map alias to display the Quick View for the map.

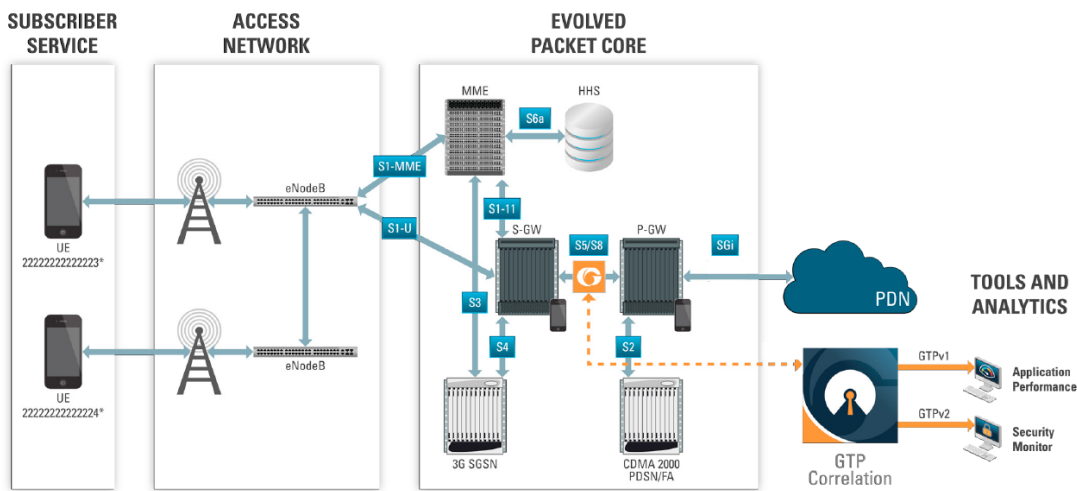
Display GTP Correlation Flow Ops Report Statistics

To display GTP correlation statistics associated with the GigaSMART group, select **GigaSMART > GigaSMART Operations > Statistics**.

Refer to *Flow Ops Report Statistics Definitions for GTP* on page 635 for descriptions of these statistics.

Example 2: Identifying GTP Versions

As part of GTP correlation, GigaVUE nodes also provide the flexibility to identify GTPv1 and GTPv2 messages. GTP version information is typically exchanged only as part of the control sessions. By correlating the control and user-plane sessions, GigaVUE nodes can identify, filter, and forward all sessions specific to a GTPv1 or v2 to one or more monitoring/analytic tools.



In Example 2, EMEI traffic is distributed based on GTP versions as follows:

- Filter and forward GTPv1 to a tool port
- Filter and forward GTPv2 to another tool port

Task	Description	UI Steps
1	Configure one network and two tool type of ports.	<ol style="list-style-type: none"> 1. Select Ports > Ports > All Ports. 2. Click Quick Port Editor. 3. In the Quick View Editor set one port to Network and two ports to Tool. 4. Select Enable on each port. 5. Click OK. 6. Close the Quick Port Editor.
2	Configure a GigaSMART group and	<ol style="list-style-type: none"> 1. From the device view, select GigaSMART > GigaSMART

Task	Description	UI Steps
	associate it with a GigaSMART engine port.	<p>Groups > GigaSMART Groups.</p> <ol style="list-style-type: none"> 2. Click New. 3. Type a name for the GigaSMART Group in the Alias field. 4. Click in the Port List field and select an engine port. 5. Under GTP Flow set the Timeout. The default is value is 48, which is 480 minutes. 6. Click Save.
3	Configure the GigaSMART operation and assign it to the GigaSMART group to enable GTP correlation.	<ol style="list-style-type: none"> 1. From the device view, select GigaSMART > GigaSMART Operations > GigaSMART Operation. 2. Type a name for the GigaSMART Group in the Alias field. 3. Click in the GigaSMART Operations (GSOP) field and select Flow Filtering. 4. Click Save.
4	Configure a virtual port and assign it to the same GigaSMART group.	<ol style="list-style-type: none"> 1. From the device view, select GigaSMART > Virtual Ports. 2. Click New. 3. Type a name for the virtual port in the Alias field. 4. Click in the GigaSMART Groups field, and select the GigaSMART Group created in Task 2. 5. Click Save.
5	<p>Create a first level map that directs GTP traffic from physical network ports to the virtual port you created in the previous task.</p> <div data-bbox="272 1192 721 1283" style="border: 1px solid #ccc; padding: 5px; margin-top: 10px;"> <p>NOTE: In the rules, 2123 is GTP-c traffic and 2152 is GTP-u traffic.</p> </div>	<ol style="list-style-type: none"> 1. Select Maps > Maps > Maps 2. Click New. 3. Configure the map. <ul style="list-style-type: none"> • Enter an alias • Select First Level for Type • Select By Rule for Subtype • Select a network port for the Source • Select the virtual port configured int Task 4 for the Destination 4. Create Rule 1. <ol style="list-style-type: none"> a. Click Add a Rule b. Select Pass. c. Select Bi Directional. d. Select Port Source e. Set the source to 2123 6. Create Rule 2. <ol style="list-style-type: none"> a. Click Add Rule

Task	Description	UI Steps
		<ul style="list-style-type: none"> b. Select Pass. c. Select Bi Directional d. Select Port Source e. Set the source to 2153 <p>6. Create Rule 3.</p> <ul style="list-style-type: none"> a. Click Add Rule b. Select Pass. c. Select IPv4 Fragmentation d. Set Value to allFragNoFirst <p>5. Click Save.</p>
6	<p>Create a second level map that takes traffic from the virtual port, applies the GigaSMART operation, matches IMEIs specified by the flow rule, and sends matching traffic to a tool port.</p>	<ul style="list-style-type: none"> 1. Select Maps > Maps > Maps 2. Click New. 3. Configure the map. <ul style="list-style-type: none"> • Enter an alias • Select Second Level for Type • Select Flow Filter for Subtype • Select a the virtual port configured in Task for the Source • Select the a tool port configured in Task 1 for the Destination • Select the GigaSMART Operation created in Task 3 from the GSOP list. 4. Create a rule. <ul style="list-style-type: none"> a. Click Add a Rule. b. Select Pass. c. Select GTP IMSI. d. Enter * in the IMSEI field and set Version to V1 5. Click Save.
7	<p>Create a second level map that takes traffic from the virtual port, applies the GigaSMART operation, matches IMEIs specified by the flow rule, and sends matching traffic to another tool port.</p>	<ul style="list-style-type: none"> 1. Select Maps > Maps > Maps 2. Click New. 3. Configure the map. <ul style="list-style-type: none"> • Enter an alias • Select Second Level for Type • Select Flow Filter for Subtype

Task	Description	UI Steps
		<ul style="list-style-type: none"> • Select a the virtual port configured in Task for the Source • Select the second tool port configured in Task 1 for the Destination • Select the GigaSMART Operation created in Task 3 from the GSOP list. <ol style="list-style-type: none"> 4. Create a rule. <ol style="list-style-type: none"> a. Click Add a Rule. b. Select Pass. c. Select GTP IMSEI. d. Enter * in the IMSI field and set Version to V2 5. Click Save.
8	Display the configuration for Example 2.	<p>To display the configuration for the GigaSMART Group:</p> <ol style="list-style-type: none"> 1. From the device view, select GigaSMART > GigaSMART Groups > Maps. 2. Click on the alias for the GigaSMART Group to display the Quick View. <p>To display the configuration for the GigaSMART Group:</p> <ol style="list-style-type: none"> 1. From the device view, select GigaSMART > GigaSMART Operations (GSOP) > GigaSMART Operations 2. Click on the alias for the GigaSMART Operation to display the Quick View. <p>To display the configuration for the maps:</p> <ol style="list-style-type: none"> 1. Select Maps > Maps > Maps. 2. Click on the map alias to display the Quick View for the map.

Example 3: Same Subscriber, Filter on Different Versions

In this example, traffic from the same subscriber is forwarded to two different load balancing groups based on version. GTP version 1 traffic is sent to one load balancing group and GTP version 2 traffic is sent to another load balancing group.

Task	Description	UI Steps
1	Configure one network and multiple tool type of ports.	<ol style="list-style-type: none"> 1. Select Ports > Ports > All Ports. 2. Click Quick Port Editor. 3. In the Quick View Editor set one port to Network and

Task	Description	UI Steps
		<p>multiple ports to Tool. For example, set 1/2/g1 as a Network port and ports 1/2/g5 through 1/2/g9 as Tool ports.</p> <ol style="list-style-type: none"> 4. Select Enable on each port. 5. Click OK. 6. Close the Quick Port Editor.
2	Configure a GigaSMART group and associate it with a GigaSMART engine port.	<ol style="list-style-type: none"> 1. From the device view, select GigaSMART > GigaSMART Groups > GigaSMART Groups. 2. Click New. 3. Type a name for the GigaSMART Group in the Alias field. 4. Click in the Port List field and select an engine port. 5. Click Save.
3	Configure the GigaSMART operation and assign it to the GigaSMART group.	<ol style="list-style-type: none"> 1. From the device view, select GigaSMART > GigaSMART Operations > GigaSMART Operations. 2. Type a name for the GigaSMART Group in the Alias field. 3. Click in the GigaSMART Operations field and select Flow Filtering. 4. Click in the GigaSMART Operations field and select Load Balancing. 5. Configure the Load Balancing as follows: <ul style="list-style-type: none"> • Select Stateful • Select GTP for Type • Selecting Hashing • Select IMSI 6. Click Save.
4	Configure a virtual port and assign it to the GigaSMART group.	<ol style="list-style-type: none"> 1. From the device view, select GigaSMART > Virtual Ports. 2. Click New. 3. Type a name for the virtual port in the Alias field. 4. Click in the GigaSMART Groups field, and select the GigaSMART Group created in Task 2. 5. Click Save.
5	Create two port groups (one for version 1 traffic and one for version 2 traffic) and enable load balancing on the port groups.	<ol style="list-style-type: none"> 1. Select Ports > Port Groups > All Port Groups. 2. Click New. 3. Type a name for the GigaSMART Group in the Alias field. For example, pglbv1. 4. Select SMART Load Balancing to enable load balancing 5. Click in the Ports field and select half the tool ports configured in Task 1.

Task	Description	UI Steps
		<ol style="list-style-type: none"> 6. Repeat steps 2 through 4, creating a second port group with the other ports configured in Task 1
6	Create an ingress (first level) map.	<ol style="list-style-type: none"> 1. Select Maps > Maps > Maps. 2. Click New. 3. Configure the map. <ul style="list-style-type: none"> • Enter an alias. For example, map1_1. • Select First Level for Type • Select By Rule for Subtype • Select a network port for the Source • Select the virtual port configured in Task 4 for the Destination 4. Click Add a Rule to create a rule. <ul style="list-style-type: none"> • Select pass • Select MAC Destination • Enter a MAC address. For example, 00:a0:d1:e1:02:01 • Enter a MAC mask. For example, 0000.0000.0000 5. Click Save.
7	Create a second level map.	<ol style="list-style-type: none"> 1. Select Maps > Maps > Maps. 2. Click New. 3. Configure the map. <ul style="list-style-type: none"> • Enter an alias. For example, map2_1. • Select Second Level for Type • Select Flow Filter for Subtype • Select the virtual port configured in Task 4 for the Source • Select the first port group for Destination • Select the GigaSMART Operation configured in Task 3 from the GSOP list. 4. Click Add a Rule to create a rule. <ul style="list-style-type: none"> • Select Pass

Task	Description	UI Steps
		<ul style="list-style-type: none"> • Select GTP IMSI • Enter * in the IMSI field • Select V1 for Version <p>5. Click Save.</p>
8	Create another second level map.	<ol style="list-style-type: none"> 1. Select Maps > Maps > Maps. 2. Click New. 3. Configure the map. <ul style="list-style-type: none"> • Enter an alias. For example, map2_2. • Select Second Level for Type • Select Flow Filter for Subtype • Select the virtual port configured in Task 4 for the Source • Select the second port group for Destination • Select the GigaSMART Operation configured in Task 3 from the GSOP list. 4. Click Add a Rule to create a rule. <ul style="list-style-type: none"> • Select Pass • Select GTP IMSI • Enter * in the IMSI field • Select V2 for Version 5. Click Save.

Example 4: Same Subscriber, Filter on Different Interfaces

In this example, traffic from the same subscriber is forwarded to two different load balancing groups based on interface. In this example, VLANs 1601 and 1602 are from S5/S8 interface and VLANs 1611 and 1612 are from S11/S1-U interface. The first level maps split the VLAN traffic to different virtual ports. The second level maps send the traffic to different load balancing groups.

Task	Description	UI Steps
1	Configure one network and multiple tool type of ports.	<ol style="list-style-type: none"> 1. Select Ports > Ports > All Ports. 2. Click Quick Port Editor.

Task	Description	UI Steps
		<ol style="list-style-type: none"> 3. In the Quick View Editor set one port to Network and multiple ports to Tool. For example, set 1/2/g1 as a Network port and ports 1/2/g5 through 1/2/g9 as Tool ports. 4. Select Enable on each port. 5. Click OK. 6. Close the Quick Port Editor.
2	Configure a GigaSMART group and associate it with a GigaSMART engine port.	<ol style="list-style-type: none"> 1. From the device view, select GigaSMART > GigaSMART Groups > GigaSMART Groups. 2. Click New. 3. Type a name for the GigaSMART Group in the Alias field. 4. Click in the Port List field and select an engine port. 5. Click Save.
3	Configure the GigaSMART operation and assign it to the GigaSMART group.	<ol style="list-style-type: none"> 1. From the device view, select GigaSMART > GigaSMART Operations > GigaSMART Operations. 2. Type a name for the GigaSMART Group in the Alias field. 3. Click in the GigaSMART Operations field and select Flow Filtering. 4. Click in the GigaSMART Operations field and select Load Balancing. 5. Configure Load Balancing as follows: <ul style="list-style-type: none"> • Select Stateful • Select GTP for Type • Selecting Hashing • Select IMSI 6. Click Save.
4	Configure virtual ports and associate them with the GigaSMART group.	<ol style="list-style-type: none"> 1. From the device view, select GigaSMART > Virtual Ports. 2. Click New. 3. Type a name for the virtual port in the Alias field. 4. Click in the GigaSMART Groups field, and select the GigaSMART Group created in Task 2. 5. Click Save. 6. Repeat steps 1 through 5 to create a second virtual port.
5	Create two port groups (one for version 1 traffic and one for version 2 traffic) and enable load balancing on the port groups.	<ol style="list-style-type: none"> 1. Select Ports > Port Groups > All Port Groups. 2. Click New. 3. Type a name for the GigaSMART Group in the Alias field. For example, pglbv1. 4. Select SMART Load Balancing to enable load balancing

Task	Description	UI Steps
		<ol style="list-style-type: none"> 5. Click in the Ports field and select half the tool ports configured in Task 1. 6. Repeat steps 2 through 4, creating a second port group with the other ports configured in Task 1
6	Create a first level map.	<ol style="list-style-type: none"> 1. Select Maps > Maps > Maps. 2. Click New. 3. Configure the map. <ul style="list-style-type: none"> • Enter an alias. For example, map1_1. • Select First Level for Type • Select By Rule for Subtype • Select a network port for the Source • Select the first virtual port configured in Task 4 for the Destination 4. Click Add a Rule to create a rule. <ul style="list-style-type: none"> • Select Pass • Select VLAN • Enter 1601 for the Min value • Enter 1602 for the Max value 5. Click Save.
7	Create another first level map.	<ol style="list-style-type: none"> 1. Select Maps > Maps > Maps. 2. Click New. 3. Configure the map. <ul style="list-style-type: none"> • Enter an alias. For example, map1_2. • Select First Level for Type • Select By Rule for Subtype • Select a network port for the Source • Select the second virtual port configured in Task 4 for the Destination 4. Click Add a Rule to create a rule. <ul style="list-style-type: none"> • Select Pass • Select VLAN • Enter 1611 for the Min value

Task	Description	UI Steps
		<ul style="list-style-type: none"> • Enter 1611 for the Max value <ol style="list-style-type: none"> 5. Click Save.
8	Create a second level map.	<ol style="list-style-type: none"> 1. Select Maps > Maps > Maps. 2. Click New. 3. Configure the map. <ul style="list-style-type: none"> • Enter an alias. For example, map2_1. • Select Second Level for Type • Select Flow Filter for Subtype • Select the virtual port configured in Task 4 for the Source • Select the first port group for Destination • Select the GigaSMART Operation configured in Task 3 from the GSOP list. 4. Click Add a Rule to create a rule. <ul style="list-style-type: none"> • Select Pass • Select GTP IMSI • Enter * in the IMSI field 5. Click Save.
9	Create another second level map.	<ol style="list-style-type: none"> 1. Select Maps > Maps > Maps. 2. Click New. 3. Configure the map. <ul style="list-style-type: none"> • Enter an alias. For example, map2_2. • Select Second Level for Type • Select Flow Filter for Subtype • Select the second virtual port configured in Task 4 for the Source • Select the second port group for Destination • Select the GigaSMART Operation configured in Task 3 from the GSOP list. 4. Click Add a Rule to create a rule. <ul style="list-style-type: none"> • Select Pass

Task	Description	UI Steps
		<ul style="list-style-type: none"> • Select GTP IMSI • Enter * in the IMSI field <p>5. Click Save.</p>

Example 5: EPC Filtering

In this example, traffic for all subscribers on interfaces S11/S1-U and Gn/Gp is sent to the same load balancing group. All other traffic is dropped.

Task	Description	UI Steps
1	Configure one network and two tool type of ports.	<ol style="list-style-type: none"> 1. Select Ports > Ports > All Ports. 2. Click Quick Port Editor. 3. In the Quick View Editor set one port to Network and two ports to Tool. For example, set 1/2/g1 as a Network port and ports 1/2/g5 and 1/2/g6 as Tool ports. 4. Select Enable on each port. 5. Click OK. 6. Close the Quick Port Editor.
2	Configure a GigaSMART group and associate it with a GigaSMART engine port.	<ol style="list-style-type: none"> 1. From the device view, select GigaSMART > GigaSMART Groups > GigaSMART Groups. 2. Click New. 3. Type a name for the GigaSMART Group in the Alias field. 4. Click in the Port List field and select an engine port. 5. Click Save.
3	Configure the GigaSMART operation and assign it to the GigaSMART group.	<ol style="list-style-type: none"> 1. From the device view, select GigaSMART > GigaSMART Operations (GSOP) > GigaSMART Operation. 2. Type a name for the GigaSMART Group in the Alias field. 3. Click in the GigaSMART Operations field and select Flow Filtering. 4. Click in the GigaSMART Operations (GSOP) field and select Load Balancing. 5. Configure the Load Balancing as follows. <ul style="list-style-type: none"> • Select Stateful • Select GTP for Type • Selecting Hashing

Task	Description	UI Steps
		<ul style="list-style-type: none"> • Select IMSI <ol style="list-style-type: none"> 6. Click Save.
4	Configure a virtual port and assign it to the GigaSMART group.	<ol style="list-style-type: none"> 1. From the device view, select GigaSMART > Virtual Ports. 2. Click New. 3. Type a name for the virtual port in the Alias field. 4. Click in the GigaSMART Groups field, and select the GigaSMART Group created in Task 2. 5. Click Save.
5	Create a port group enable load balancing on the port group.	<ol style="list-style-type: none"> 1. Select Ports > Port Groups > All Port Groups. 2. Click New. 3. Type a name for the GigaSMART Group in the Alias field. For example, pglbv1. 4. Select SMART Load Balancing to enable load balancing 5. Click Save.
6	Create an ingress (first level) map. <div data-bbox="272 926 740 1014" style="border: 1px solid #ccc; padding: 5px; margin-top: 10px;"> <p>NOTE: In the rules, 2123 is GTP-c traffic and 2152 is GTP-u traffic.</p> </div>	<ol style="list-style-type: none"> 1. Select Maps > Maps > Maps 2. Click New. 3. Configure the map. <ul style="list-style-type: none"> • Enter an alias • Select First Level for Type • Select By Rule for Subtype • Select a network port for the Source • Select the virtual port configured in Task 4 for the Destination 4. Create Rule 1. <ol style="list-style-type: none"> a. Click Add a Rule b. Select Pass. c. Select Bi Directional. d. Select Port Source e. Set the source to 2123 6. Create Rule 2. <ol style="list-style-type: none"> a. Click Add Rule b. Select Pass. c. Select Bi Directional d. Select Port Source e. Set the source to 2152

Task	Description	UI Steps
		<ol style="list-style-type: none"> 6. Click Save.
7	<p>Create a second level map that takes traffic from the virtual port, applies the GigaSMART operation, matches IMSIs specified by the flow rules, and sends matching traffic to physical tool ports.</p>	<ol style="list-style-type: none"> 1. Select Maps > Maps > Maps. 2. Click New. 3. Configure the map. <ul style="list-style-type: none"> • Enter an alias. • Select Second Level for Type • Select Flow Filter for Subtype • Select the virtual port configured in Task 4 for the Source • Select the port group for Destination • Select the GigaSMART Operation configured in Task 3 from the GSOP list. 4. Create the rule 1. <ol style="list-style-type: none"> a. Click Add a Rule b. Select Pass c. Select GTP IMSI d. Enter * in the IMSI field e. Select Interface and set it to Gg/Gp 6. Create rule 2. <ol style="list-style-type: none"> a. Click Add a Rule b. Select Pass c. Select GTP IMSI d. Enter * in the IMSI field e. Select Interface and set it to S11/S1U 6. Click Save.

Example 6: EPC Filtering

In this example, traffic for all subscribers from all interfaces except S5/S8 is sent to the same load balancing group. Traffic from the S5/S8 interface is dropped.

Step	Description	UI Steps
1	<p>Configure one network and two tool type of ports.</p>	<ol style="list-style-type: none"> 1. Select Ports > Ports > All Ports. 2. Click Quick Port Editor.

Step	Description	UI Steps
		<ol style="list-style-type: none"> 3. In the Quick View Editor set one port to Network and two ports to Tool. For example, set 1/2/g1 as a Network port and ports 1/2/g5 and 1/2/g6 as Tool ports. 4. Select Enable on each port. 5. Click OK. 6. Close the Quick Port Editor.
2	Configure a GigaSMART group and associate it with a GigaSMART engine port.	<ol style="list-style-type: none"> 1. From the device view, select GigaSMART > GigaSMART Groups > GigaSMART Groups. 2. Click New. 3. Type a name for the GigaSMART Group in the Alias field. 4. Click in the Port List field and select an engine port. 5. Click Save.
3	Configure the GigaSMART operation and assign it to the GigaSMART group.	<ol style="list-style-type: none"> 1. From the device view, select GigaSMART > GigaSMART Operations (GSOP) > GigaSMART Operation. 2. Type a name for the GigaSMART Group in the Alias field. 3. Click in the GigaSMART Operations (GSOP) field and select Flow Filtering. 4. Click in the GigaSMART Operations (GSOP) field and select Load Balancing. 5. Configure Load Balancing as follows: <ul style="list-style-type: none"> • Select Stateful • Select GTP for Type • Selecting Hashing • Select IMSI 6. Click Save.
4	Configure a virtual port and assign it to the GigaSMART group.	<ol style="list-style-type: none"> 1. From the device view, select GigaSMART > Virtual Ports. 2. Click New. 3. Type a name for the virtual port in the Alias field. 4. Click in the GigaSMART Groups field, and select the GigaSMART Group created in Task 2. 5. Click Save.
5	Create a port group and enable load balancing on the port group.	<ol style="list-style-type: none"> 1. Select Ports > Port Groups > All Port Groups. 2. Click New. 3. Type a name for the GigaSMART Group in the Alias field. For example, pglbv1. 4. Select SMART Load Balancing to enable load balancing

Step	Description	UI Steps
		<ol style="list-style-type: none"> 5. Click Save.
6	<p>Create an ingress (first level) map.</p> <div style="border: 1px solid gray; padding: 5px; margin-top: 10px;"> <p>NOTE: In the rules, 2123 is GTP-c traffic and 2152 is GTP-u traffic.</p> </div>	<ol style="list-style-type: none"> 1. Select Maps > Maps > Maps 2. Click New. 3. Configure the map. <ul style="list-style-type: none"> • Enter an alias • Select First Level for Type • Select By Rule for Subtype • Select a network port for the Source • Select the virtual port configured in Task 4 for the Destination 4. Create Rule 1. <ol style="list-style-type: none"> a. Click Add a Rule b. Select Pass. c. Select Bi Directional. d. Select Port Source e. Set the source to 2123 6. Create Rule 2. <ol style="list-style-type: none"> a. Click Add Rule b. Select Pass. c. Select Bi Directional d. Select Port Source e. Set the source to 2152 6. Click Save.
7	<p>Create a second level map that takes traffic from the virtual port, applies the GigaSMART operation, matches IMSIs specified by the flow rules, and sends matching traffic to physical tool ports.</p>	<ol style="list-style-type: none"> 1. Select Maps > Maps > Maps. 2. Click New. 3. Configure the map. <ul style="list-style-type: none"> • Enter an alias. • Select Second Level for Type • Select Flow Filter for Subtype • Select the virtual port configured in Task 4 for the Source • Select the port group for Destination • Select the GigaSMART Operation configured

Step	Description	UI Steps
		<p>in Task 3 from the GSOP list.</p> <ol style="list-style-type: none"> 4. Create the rule 1. <ol style="list-style-type: none"> a. Click Add a Rule b. Select drop c. Select GTP IMSI d. Enter * in the IMSI field e. Select Interface and set it to S5/S8 6. Create rule 2. <ol style="list-style-type: none"> a. Click Add a Rule b. Select Pass c. Select GTP IMSI d. Enter * in the IMSI field 5. Click Save.

GigaSMART Diameter S6a Correlation

Required Licenses: Diameter correlation license is available as a Base (100,000 users) and Max license (maximum number of users).

Diameter is an application layer protocol used in the GTP Mobile Infrastructure for authentication, authorization and accounting. The Diameter protocol uses SCTP protocol (and also TCP protocol). Thousands of diameter transactions occur every second on a relatively low network segment. Therefore, it is important to load balance the diameter transactions to the diameter processing probes (that have a finite capacity).

The GigaSMART Diameter Correlation application load balances the Diameter traffic to the LTE sessions of each of the subscriber such that the probes receive the S6a traffic for the given IMSI/MSISDN.

The application performs the following functions:

- Correlates Diameter S6a message
- Provides support for FlowVUE functionality with Stateful Load balancing (based on IMSI/MSISDN)
- Provides single engine support and allows engine grouping, as well
- Provides IPv4 support

Diameter Correlation Engine

The Diameter Correlation Engine correlates the messages exchanged during the initial attach of the subscriber (except the reset messages). Each message has a mandatory field called Session-ID and User Name, and these fields are used to correlate the messages for a given subscriber.

When a message containing Diameter traffic is received, the Diameter correlation engine looks up the session in the session table for load balancing ports and sampling maps or whitelist map.

NOTE: The GigaSMART Diameter Correlation application uses dynamic memory instead of fixed memory. It can run with GTP and other compatible applications.

Diameter Whitelisting in a Cluster

The Diameter whitelist contains user names (IMSI) and command codes. Whitelist entries can only be numeric. For each entry, you can specify up to 14 to 15 numeric characters.

You can manually add one entry at a time to a whitelist file, or you can upload files in.txt format. Each whitelist file can have up to 20,000 entries. One or more whitelist files can be fetched from a local directory or remote URL using HTTP or SCP.

On GigaVUE-HC1 and GigaVUE-HC2 nodes, the whitelist database supports 500,000 entries. On GigaVUE-HC3 nodes, the whitelist database supports 1 million entries.

The GigaSMART operation does not have any rules for whitelisting.

Diameter Flow Sampling

FlowVUE is used for session-aware (stateful) load balancing and whitelisting with sampling.

Up to 10 flow sample maps per GigaSMART group are supported. Each flowsample map can have 20 rules. Use rules to filter based on User Name. The rules support numbers and wild card entries, up to 15 characters.

Sampling is based on **User Name** field.

Configure Diameter S6a Correlation

To access GigaSMART within GigaVUE-FM, access a device that has been added to GigaVUE-FM from the GigaVUE-FM interface. GigaSMART appears in the navigation pane of the device view on supported devices. Refer to [Access GigaSMART from GigaVUE-FM](#) for details.

The following table summarizes the tasks required for configuring GigaSMART Diameter S6a :

Configure GigaSMART Groups	Configure GigaSMART Group
Create Virtual Ports	Create Virtual Ports
Configure GigaSMART Operations: Diameter Flow Sampling	Configure GigaSMART Operation: Diameter Flow Sampling
Configure GigaSMART Operations: Diameter Whitelisting	Configure GigaSMART Operation: Diameter Whitelisting
Display Diameter Report	Display Diameter Reports

Configure GigaSMART Group

To configure a GigaSMART group and associate it with a GigaSMART engine port do the following.

1. From the device view, select **GigaSMART > GigaSMART Groups**.
2. Click **New**. Configure a GigaSMART group and associate it with a GigaSMART engine port do the following.
3. Type an alias in the Alias field and enter **an engine port** in the Port List field.

The screenshot shows a configuration window titled "GigaSMART Group" with "OK" and "Cancel" buttons. Under the "GigaSMART Group Info" section, the "Alias" field is populated with "gs1g". The "Port List" field is a dropdown menu that is currently open, displaying "E 5/3e1 x".

Figure 363: GigaSMART Group Port Info

4. Scroll down the page to select **Diameter S6a Session** parameters.
 - Session Limit (1K)
 - Session Timeout (seconds)
 - Diameter Packet Timeout (seconds)

The screenshot displays the "Diameter" configuration section. Under "Diameter S6a Session", there are three input fields: "Session Limit (1K)" with the value "1 - 10000", "Session Timeout (seconds)" with "30 - 300", and "Diameter Packet Timeout (seconds)" with "1 - 5". Below this is the "Diameter Whitelist" section, which includes an "Alias" dropdown menu currently set to "None".

Figure 364: Diameter Port Parameters.

5. Click **OK**.

Create Virtual Ports

To access GigaSMART within GigaVUE-FM, access a device that has been added to GigaVUE-FM from the GigaVUE-FM interface. GigaSMART appears in the navigation pane of the device view on supported devices. Refer to [Access GigaSMART from GigaVUE-FM](#) for details.

To create virtual ports, do the following:

1. From the device view, select **GigaSMART > Virtual Ports**.
2. Click **New**.

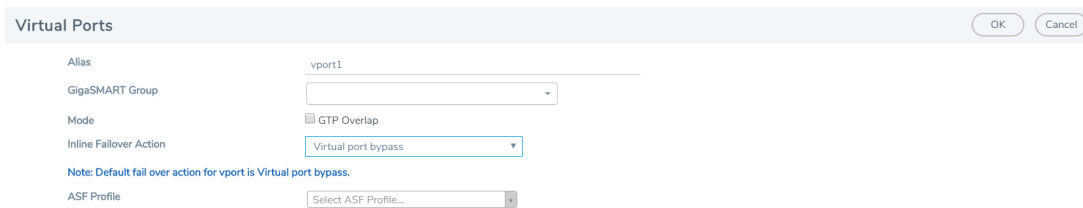


Figure 365: Virtual Ports

3. Enter an **alias** in the Alias field to identify the virtual port.
4. In the GigaSMART Groups field, select the GigaSMART Group configured in Step 1: of Configure a GigaSMART Group.
5. Click **Save**.

Configure GigaSMART Operation: Diameter Flow Sampling

Define a GigaSMART operation to enable Diameter Flow Sampling. If combining Flow Sampling with Load Balancing GSOPs, make sure that you select both operations when creating the GigaSMART Operation.

To access GigaSMART within GigaVUE-FM, access a device that has been added to GigaVUE-FM from the GigaVUE-FM interface. GigaSMART appears in the navigation pane of the device view on supported devices. Refer to [Access GigaSMART from GigaVUE-FM](#) for details.

To configure the GigaSMART Operation, do the following:

1. From the device view, select **GigaSMART > GigaSMART Operations (GSOP)**.
2. Click **New**. On the GigaSMART Operations page, do the following:

Figure 366: GigaSMART Operations page

3. In the Alias field, enter an **alias** to help identify this GSOP.
4. In the **GigaSMART Groups** field, select the **GigaSMART group** configured in Step 1: Configure a GigaSMART Group.
5. In the GigaSMART Operations (GSOP) field, select **Flow Sampling - Diameter**.
6. Using the GSOP drop down list, select **Load Balancing** as the next GSOP operation.

Figure 367: GigaSMART Operations - Load Balancing

Options are:

- Stateful
- Stateless
- Enhanced

7. Select **Stateful**.

NOTE: Only Stateful load balancing option is supported for Diameter S6a Correlation.

8. For Type, select **Diameter** as the stateful application within a group of GigaSMART operations.
9. Select **Diameter Hashing** as the Load Balancing Method.
10. Select the required **Hashing Key**. Options are:
 - User Name
 - Command Code
11. Click **OK**.

Create first level map.

1. Select **Maps > Maps > Maps**.
2. Click **New**.
3. Type **map-level1** in the Alias field.
4. Select **First Level** for Type and **By Rule** for Subtype.
5. Select **port 1/1/x1** for the Source.

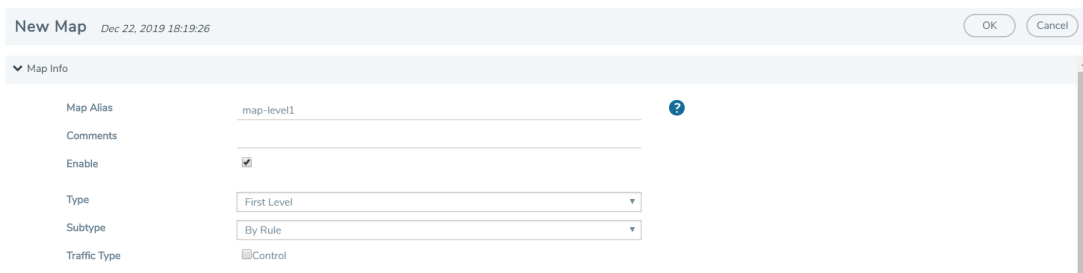


Figure 368: Create New Map

6. Select **virtual port vport1** for the Destination.
7. Click **Add a Rule** to add Rule 1
8. Click **Save**.

Create second level map for Diameter Flow Sampling.

1. Select **Maps > Maps > Maps**.
2. Click **New**.
3. Type an **alias** in the Alias field.
4. Select Second Level for Type and **Flow Sample Diameter** for Subtype.
5. Select virtual port **vport1** for the Source.
6. Select **port group** for the Destination.
7. Select from the GSOP list.
8. Click **Add a Rule**.

9. Select **Diameter** for the condition.

The screenshot displays the configuration interface for creating a second-level map. It is divided into three main sections:

- Map Info:** Contains fields for 'Map Alias' (set to 'Map_Diameter'), 'Comments', 'Enable' (checked), 'Type' (set to 'Second Level'), and 'Subtype' (set to 'Flow Sample Diameter').
- Map Source and Destination:** Includes a 'Port Editor' button, 'Source' and 'Destination' dropdowns (both set to 'Select ports...'), 'Encapsulation Tunnel' (set to 'None'), and 'GigaSMART Operations (GSO)' (set to 'None').
- Map Rules:** Shows 'Rule 1' with a dropdown menu set to 'Diameter'. Below it, a dialog box contains 'Percentage' (1), 'User Name' (e.g., 12345678901234), and 'Interface' (SEA).

Figure 369: Create Second Level Map

10. Enter the following details:

- **Percentage** for the amount of traffic you want to be affected by Diameter flow sampling
- User Name
- Interface

11. Click **Save**.**Configure GigaSMART Operation: Diameter Whitelisting**

1. From the device view, select **GigaSMART > Whitelist**.
2. Click **New**.
3. Type an **alias** in the Alias field.
4. Select the Whitelist type as **Diameter**.
5. You can either upload the details manually (you must enter the Diameter Entry) or load whitelist files from a specified location to populate the Diameter whitelist. You can either:
 - **Upload from URL:** Enter the URL in the **Remote URL** field and the Password required to access the URL.
 - **Upload a File:** Choose the location of the file name
6. Click **OK**.

Associate GigaSMART group to Diameter whitelist

1. From the device view, select **GigaSMART > GigaSMART Groups > GigaSMART Groups**.
2. Select the **GigaSMART Group** you previously created and click **Edit**.
3. Under **Diameter Whitelist**, select the **alias** previously created from the available list.

4. Click **OK**.

Configure GigaSMART operation for Diameter whitelisting

1. From the device view, select **GigaSMART > GigaSMART Operations > GigaSMART Operation**.
2. Click **New**.
3. Type an **alias** in the Alias field.
4. Select the GigaSMART group created in task 1.
5. From the GigaSMART Operations (GSOP) drop-down list, select the following:
 - **Whitelist** and select **Diameter**.
 - **Load Balancing**.
6. For Load Balancing, do the following:
 - a. Choose: **Stateful**
 - b. For Type select: **Diameter**
 - c. Select Diameter Hashing and enter the following Hashing Key parameters:
 - User Name
 - Command Code
7. Click **OK**.

Configure first level map

1. Select **Maps > Maps > Maps**.
2. Click **New**.
3. Configure the map:
 - a. Enter an **Alias**
 - b. Type: **First Level**, Sub Type: **By Rule**
 - c. Source: **1/1/g2**
 - d. Destination: **vport**
4. Click **Add a Rule**.
5. Click **Save**.

Create another second level map for Diameter flow whitelist

1. Select **Maps > Maps > Maps**.
2. Click **New**.

3. Configure the map:
 - a. Alias: **alias name**
 - b. Type: **Second Level**, Sub Type: **Flow Whitelist Diameter**
 - c. Source: **vport1**
 - d. Destination: **Port group**
 - e. Select from the **GSOP** list.
4. Click **OK**.

Display Diameter Reports

To display Diameter report, do the following:

1. From the device view, select GigaSMART > **GigaSMART Groups > Report**.
2. Select Group Type: **Flow Diameter S6a**.
3. Select the required GigaSMART Groups: **gsg1**
4. Specify the **User Name Pattern**.
5. Select Any. This returns any pattern.

The screenshot shows the 'GigaSMART Groups' navigation menu with 'Report' selected. A 'Generate' button is visible in the top right. Below the navigation is a 'Report Info' section with the following fields:

Type	Flow Diameter S6a
GigaSMART Groups	Select...
User Name Pattern	Type User Name Pattern...(e.g. 55512312341223) <input checked="" type="checkbox"/> Any

Figure 370: Generate Diameter Report

6. Click the **Generate** button. The Diameter Messages Report is displayed.

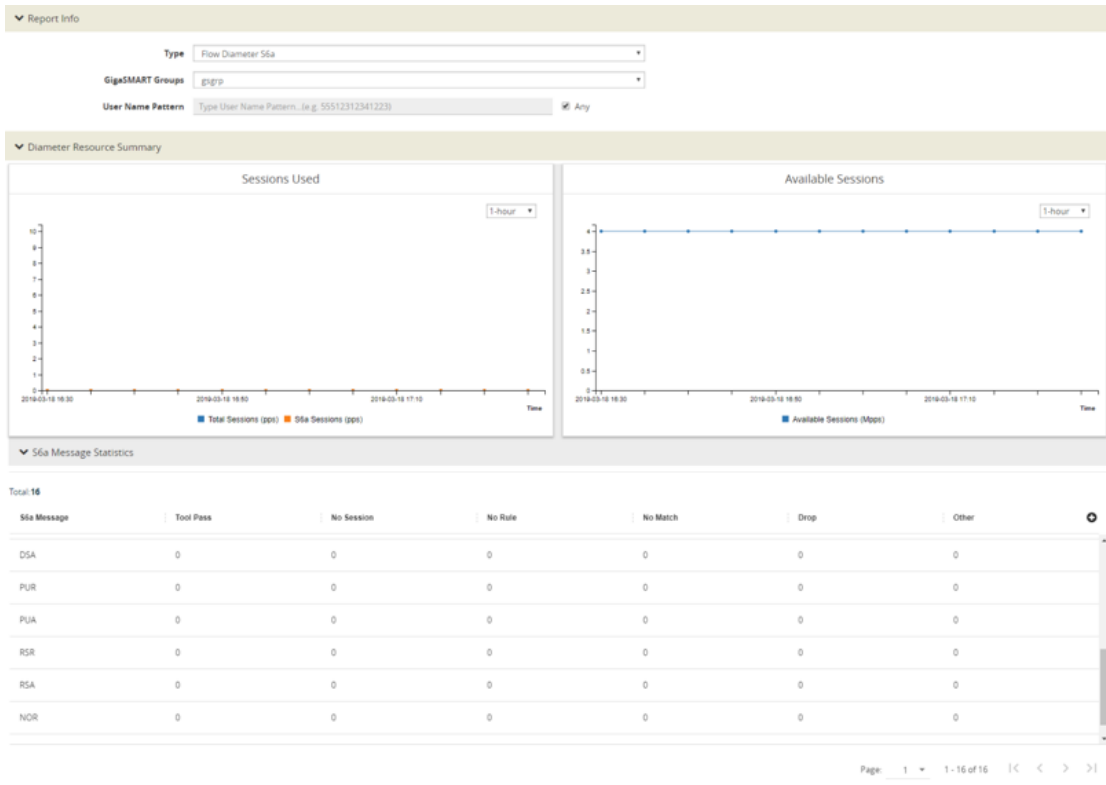


Figure 371: Diameter Report Page

GigaSMART SIP/RTP Correlation

Required Licenses: SIP/RTP Correlation (and FlowVUE for session-aware load balancing for RTP)

Session Initiation Protocol (SIP) is the dominant method to initiate, maintain, modify, and terminate voice calls in service provider and enterprise networks. Real-time Transport Protocol (RTP) is used to manage the real-time transmission of voice payload across the same networks. Visibility into a subscriber’s voice traffic requires the ability to understand the subscriber attributes and stateful information contained within SIP to correlate subscriber-specific RTP traffic so that monitoring tools can achieve an accurate view of the subscriber’s traffic on the network.

The GigaSMART SIP/RTP correlation application correlates the subscriber-specific attributes and the endpoint identifiers of the RTP streams where the session is carried, as well as other SIP-related attributes that are exchanged as part of the control sessions. Use SIP/RTP correlation to leverage a subscriber-aware monitoring policy on

Gigamon's Visibility platform and to optimize current tool infrastructure investments by providing only relevant data to tools while increasing visibility into subscriber traffic. This helps improve QoE and performance. Carriers gain access to the subscriber's traffic by reliably correlating and passing all the identified subscriber's control and data sessions to the analytics/monitoring probes and/or billing subsystems for an accurate view of the subscriber's sessions.

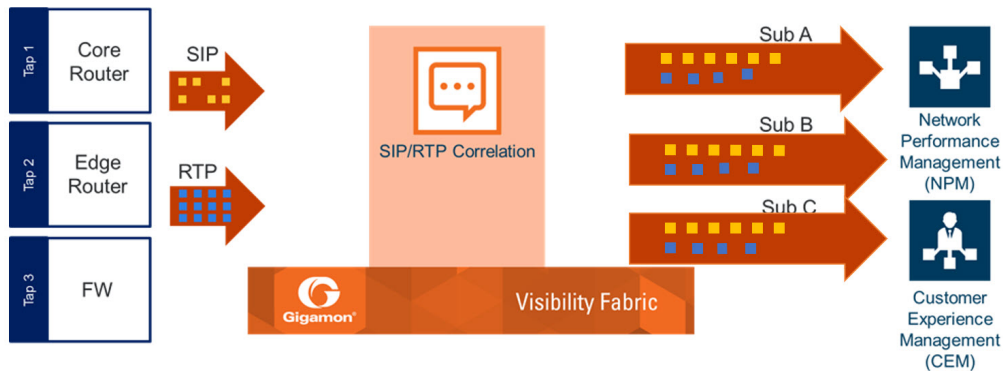


Figure 372: SIP/RTP Correlation

SIP is a signaling protocol for VoIP and VoLTE call initiation. It is implemented with RTP to control the payload. GigaSMART SIP/RTP correlation provides customers visibility into VoIP, VoLTE, SMSoLTE, and RCS traffic, and allows them to filter and forward traffic for a subscriber to the tools.

All SIP traffic is sent to all tool ports, as follows:

- all SIP packets sent to all ports within a load balancing port group.
- all SIP packets sent to all ports within a GigaStream.
- all SIP packets sent to all tool ports belonging to maps.

RTP traffic will be sampled and sent to the maps with the rules that match. RTP non-correlated traffic will be sent to the collector.

SIP/RTP correlation can be used for both enterprise and service providers, where ever there is SIP/RTP traffic, such as in wire-line communications, wireless communications, and packet cable networks. This includes enterprise, IP Multimedia Subsystem (IMS), or fixed network implementations of SIP, as well as any media controlled by SIP, such as voice, text, or streaming media.

In addition, SIP/RTP correlation correlates SIP signaling and RTP payload for all sessions selected by a SIP User Agent (UA), a caller ID in a whitelist, with flow sampling from 0 to 100%.

CallerID Tracking

The CallerID is tied to the Call-ID and remains constant for the duration of the session:

CallerID (A) <------(Call-ID)-----> CalleeID (B)

CallerID tracking is based on the initial caller (A) and does not change until the Call-ID changes. Even if the callee, (B), sends a new INVITE during the SIP session, if that INVITE uses the same Call-ID, then the CallerID information in the SIP session display will still identify the initial caller, (A); it will not switch to reflect that (B) is now the caller.

Support for SIP, RTP, and RTCP

SIP/RTP correlation handles all SIP signaling and RTP/RTCP traffic, including RTCP control traffic, as well as that belonging to a call session.

The following is supported:

- Non-tunneled SIP, RTP, and RTCP correlation (all IMS interfaces)
- Tunneled SIP, RTP, and RTCP correlation (SIP/RTP/RTCP in GTP-U, through the GTP tunnel)

SIP/RTP Correlation Engine

When a packet containing SIP, RTP, or RTCP traffic is received, the SIP/RTP correlation engine looks up the session in the session table for load balancing ports and sampling maps or whitelist map. All SIP/RTP traffic with port or load balancing port group is forwarded based on the session table. The correlation engine load balancing keeps track of both the SIP session and the associated multiple RTP channels.

Each session identifies both sides of media streams (RTP) associated with the session. The SIP session has an aging timer that is configurable.

When a session matches one of the configured flow sampling rules, it is either accepted for sampling or rejected. If it is accepted, all packets belonging to that session are sent to the tool port. Otherwise, all packets belonging to the session are dropped.

All SIP traffic is sent to all tool ports, as follows:

- all SIP packets sent to all ports within a load balancing port group
- all SIP packets sent to all ports within a GigaStream
- all SIP packets sent to all tool ports belonging to maps

RTP traffic will be sampled and sent to the maps with the rules that match. RTP non-correlated traffic will be sent to the collector.

Only one SIP interface type is supported per engine, for example, S5. There is no mixing of interface types, such as S5 GTP-U with SGI.

SIP Whitelist

The SIP whitelist contains caller IDs, callee ID, the range for caller IDs, the range for callee IDs and the IP address. Each whitelist entry in a file is a SIP caller ID, callee ID, caller ID range, callee ID range or IP address. The whitelist can contain all types of entries.

Whitelist entries can be alphabetic, IP address, and numeric. For each entry, specify up to 64 alphanumeric characters. Some special characters are also supported.

You can manually add one entry at a time to a whitelist file, or you can upload files in.txt format. You must provide the whitelist caller ID range in numeric. You can also provide multiple entries to the whitelist by ID range configuration. Each whitelist file can have up to 20,000 entries. One or more whitelist files can be fetched from a local directory or remote URL using HTTP or SCP.

On GigaVUE-HC2 nodes, the whitelist database supports 500,000 entries. On GigaVUE-HC3 nodes, the whitelist database supports 1 million entries.

Multiple whitelist databases can reside on a GigaVUE node, but only one whitelist is applied to a GigaSMART group at a time.

Only one whitelist map is supported for a GigaSMART group. The GigaSMART operation does not have any rules for whitelisting.

RTP Flow Sampling

FlowVUE is used for session-aware (stateful) load balancing and whitelisting with sampling. Only RTP traffic will be sampled. There is no sampling of SIP traffic.

Up to five flow sample maps per GigaSMART group are supported. Each flow sample map can have 20 rules. Use rules to filter on caller ID. The rules support both alphabetic and numeric characters, up to 64 characters. Some special characters are also supported, such as wildcard characters.

Sampling is based on caller ID only (the from field).

Support for Sessions

The number of supported SIP and RTP sessions are as follows:

- GigaVUE-HC3—1 million SIP sessions and 4 million concurrent RTP sessions
- GigaVUE-HC2—500,000 SIP sessions and 2 million concurrent RTP sessions

Each SIP session can handle two RTP streams in both directions (bidirectional).

The number of supported TCP sessions are as follows:

- GigaVUE-HC3—2 million sessions
- GigaVUE-HC2—1 million sessions

Support for IPv4 and IPv6

SIP is a text-based protocol, which is supported over UDP and TCP. The size of the SIP message can vary greatly, so fragmentation and segmentation are common and are supported for tunneled SIP and non-tunneled SIP (IMS).

IPv4 and IPv6 are supported as follows:

- UDP Fragmentation—in-order packets, out-of-order packets
- TCP Segmentation—in-order packets, out-of-order packets

The following is not supported:

- GTP tunneled packets where the inner IP is fragmented
- IMS packets where the outer IP is fragmented

		UDP				TCP		
		Outer Frag	Inner Frag	In order	Out of order	Segmentation	In order	Out of order
GTP	IPv4	✓	x	✓	✓	✓	✓	✓
		✓	x	✓	✓	✓	✓	✓
	IPv6	✓	x	✓	✓	✓	✓	✓
		✓	x	✓	✓	✓	✓	✓
IMS	IPv4	N/A	✓	✓	✓	✓	✓	✓
		N/A	✓	✓	✓	✓	✓	✓
	IPv6	N/A	✓	✓	✓	✓	✓	✓
		N/A	✓	✓	✓	✓	✓	✓

Figure 373: SIP/RTP UDP/TCP Support

Support for Content Masking

SIP Common Presence and Instant Messaging (CPIM) content masking is supported, but only when the SIP transport is UDP.

The SIP method, MESSAGE, carried over UDP, might contain user-friendly, readable text messages. Use masking to replace these messages with x's, so they cannot be read.

NOTE: SIP/RTP correlation cannot mask text messages with a content type other than message/CPIM", such as plain text.

Behaviors of Some SIP Methods

The following are behaviors for some particular SIP methods:

- The SIP method, REGISTER, might not contain a user part. When there is no user part, it will be treated as a parse error.
- The SIP method, OPTIONS, (and response messages) might not contain a user part. When there is no user part, it will be treated as a parse error.

NOTE: SIP TCP packets with parse errors are not sent to collector. SIP TCP packets will be sent to the tool and incremented as parse errors in the session table stats.

SIP Whitelisting in a Cluster

The whitelist (all whitelist files) reside on the master node of the cluster. The non-master nodes receive a copy of the whitelist from the master. Updates to the whitelist are synchronized from the master to the non-master nodes. If a non-master node leaves the cluster and rejoins, its whitelist will be resynchronized.

Use the cluster master preference command to specify the highest preference for the master node, the second highest preference for the standby node, and lower preferences for the normal nodes in the cluster.

If there are GigaVUE TA Series nodes in the cluster, they will not receive a copy of the whitelist.

Support for NAT

GigaSMART SIP Correlation engine correlates NAT/PAT enabled SIP/RTP packets. The correlation engine compares the top most "Via" address and the contact address of the device with the Layer 3 network address to find whether the device is configured with NAT.

To enable the NAT support, from the device view:

1. Select **GigaSMART > GigaSMART Groups > SIP > SIP NAT**.
2. Enable the **SIP NAT** check box.

Not Supported by SIP/RTP Correlation

The following list is not currently supported by SIP/RTP correlation:

- encryption
- filtering based on Codecs
- SRVCC
- roaming
- SIP-I/SIP-T
- forwarding of emergency calls to specific tools
- engine grouping. Only one engine is used for SIP/RTP correlation.

NOTE: SIP/RTP correlation and GTP correlation are not supported on the same GigaSMART engine port.

SIP/RTP Load Balancing Example

This is a load balancing configuration example of SIP/RTP.

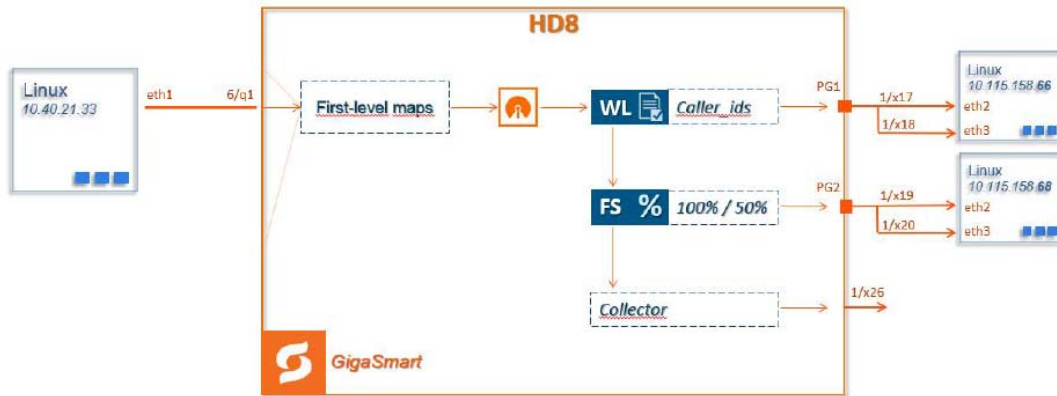


Figure 374: SIP/RTP UDP/TCP Support

SIP/RTP Minimum Configuration Example

To access GigaSMART within GigaVUE-FM, access a device that has been added to GigaVUE-FM from the GigaVUE-FM interface. GigaSMART appears in the navigation pane of the device view on supported devices. Refer to [Access GigaSMART from GigaVUE-FM](#) for details.

Configure ports

To configure a GigaSMART group and associate it with a GigaSMART engine port do the following.

1. From the device view, select **GigaSMART > GigaSMART Groups**.
2. Click **New**.
3. Type an alias in the Alias field and enter **an engine port** in the Port List field.

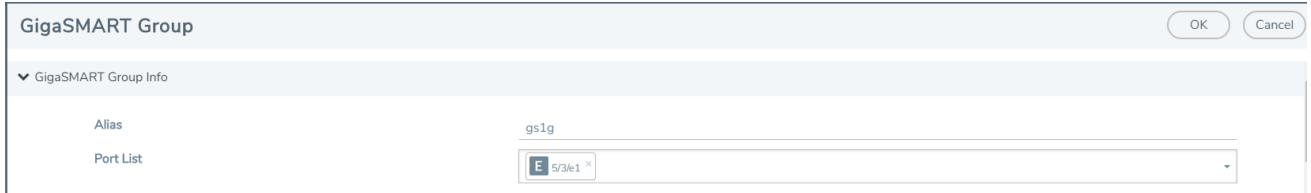


Figure 375: GigaSMART Group Port Info

4. Click **Save**.
5. Scroll down the page to select **SIP Port** parameters.
6. Type parameters for **SIP Port and RTP Port**.
7. Enter parameters for **SIP Session Timeout** and the **SIP TCP Idle Timeout**.

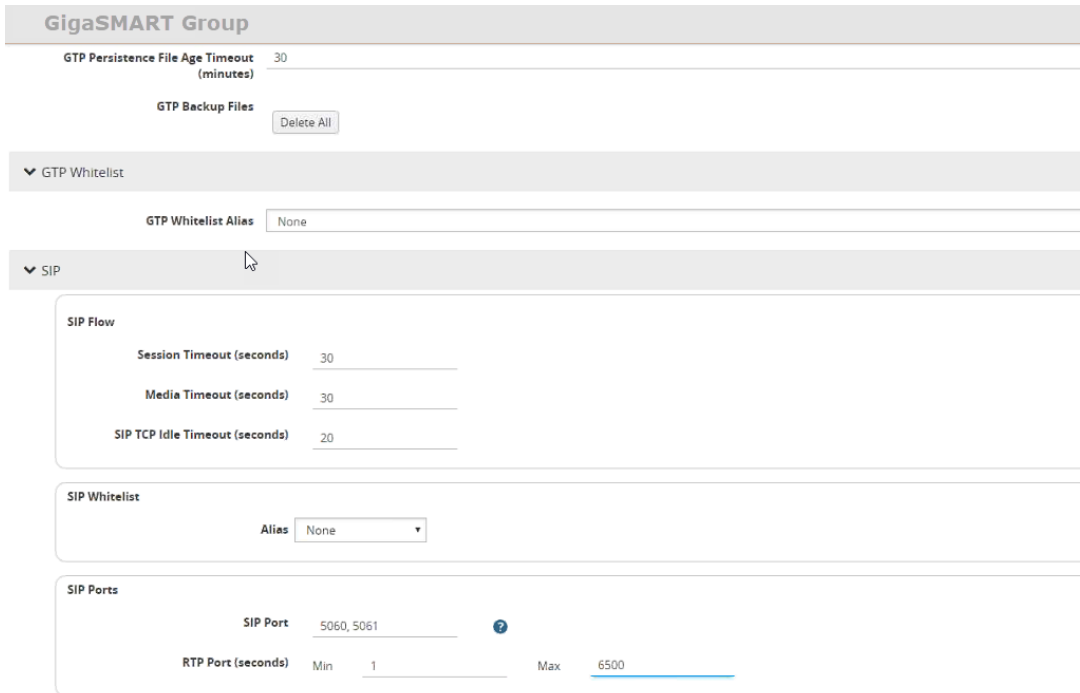


Figure 376: SIP Port parameters

8. Click **OK**.

Create Virtual Ports

To access GigaSMART within GigaVUE-FM, access a device that has been added to GigaVUE-FM from the GigaVUE-FM interface. GigaSMART appears in the navigation pane of the device view on supported devices. Refer to [Access GigaSMART from GigaVUE-FM](#) for details.

To create virtual ports, do the following:

1. From the device view, select **GigaSMART > Virtual Ports**.
2. Click **New**.

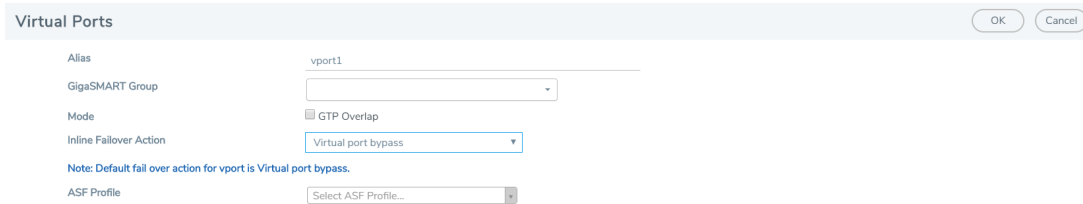


Figure 377: Virtual Ports

3. Enter an **alias** in the Alias field to identify the virtual port.
4. In the GigaSMART Groups field, select the GigaSMART Group configured in Step 1: of Configure a GigaSMART Group.
5. Click **Save**.

Configure GigaSMART Operation

Define a GigaSMART operation to enable SIP Flow Sampling. If combining Flow Sampling with Load Balancing GSOPs, make sure that you select both operations when creating the GigaSMART Operation.

To access GigaSMART within GigaVUE-FM, access a device that has been added to GigaVUE-FM from the GigaVUE-FM interface. GigaSMART appears in the navigation pane of the device view on supported devices. Refer to [Access GigaSMART from GigaVUE-FM](#) for details.

To configure the GigaSMART Operation, do the following:

1. From the device view, select **GigaSMART > GigaSMART Operations (GSOP)**.
2. Click **New**. On the GigaSMART Operations page, do the following:

Figure 378: GigaSMART Operations page

3. In the Alias field, enter an **alias** to help identify this GSOP.
4. In the **GigaSMART Groups field**, select the **GigaSMART group** configured in Step 1: Configure a GigaSMART Group.
5. In the GigaSMART Operations (GSOP) field, select **Flow Sampling for SIP**.
6. Using the GSOP drop down list, select **Load Balancing** as the next GSOP operation.

Figure 379: GigaSMART Operations - Load Balancing

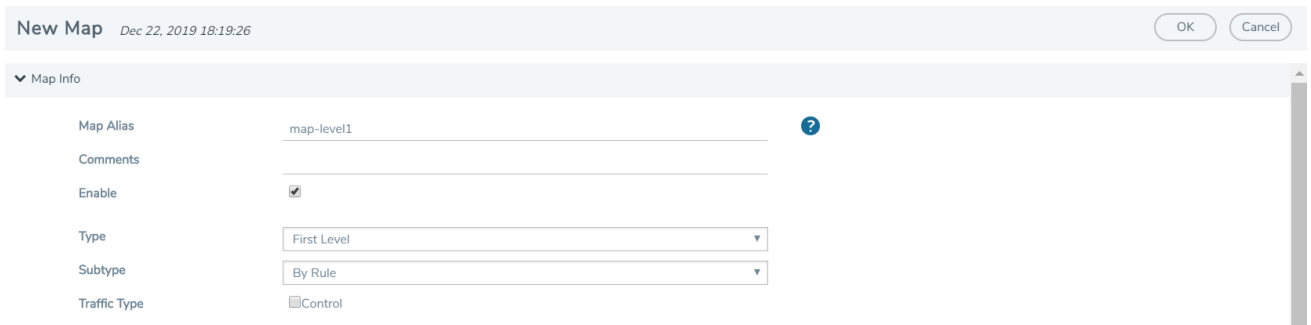
Options:

- Stateful
 - Stateless
 - Enhanced
7. Select **Stateful**.
 8. For Type, select **SIP** as the stateful application within a group of GigaSMART operations.
 9. Select **Caller ID** as the Load Balancing Method.
 10. Click **OK**.

Create first level map

1. Select **Maps > Maps > Maps**.

2. Click **New**.
3. Type **map-level1** in the Alias field.
4. Select **First Level** for Type and **By Rule** for Subtype.
5. Select **port 1/1/x1** for the Source.



The screenshot shows a 'New Map' configuration window. The title bar includes the text 'New Map' and a timestamp 'Dec 22, 2019 18:19:26', along with 'OK' and 'Cancel' buttons. Below the title bar, the 'Map Info' section is expanded, displaying several configuration fields: 'Map Alias' is set to 'map-level1'; 'Comments' is empty; 'Enable' is checked; 'Type' is set to 'First Level'; 'Subtype' is set to 'By Rule'; and 'Traffic Type' is set to 'Control'. A question mark icon is located to the right of the 'Map Alias' field.

Figure 380: Create New Map

6. Select **virtual port vport1** for the Destination.
7. Click **Add a Rule** to add Rule 1
8. Click **Save**.

Create second level map for SIP Flow Sampling.

1. Select **Maps > Maps > Maps**.
2. Click **New**.
3. Type **an alias** in the Alias field.
4. Select **Second Level** for Type and **Flow Sample SIP** for Subtype.
5. Select virtual port **vport1** for the Source.
6. Select **port group** for the Destination.
7. Select **the group** from the GSOP list.
8. Click **Add a Rule**.
9. Select **SIP** for the condition.
10. Select any of the following options:
 - Caller ID-For example, enter **408*** for Caller ID.
 - Caller ID Range
 - Callee ID
 - Callee ID Range
 - Caller/Callee ID Range

Figure 381: Create Second Level Map

11. Enter a **percentage** for amount the traffic you want to be affected by SIP flow sampling.
12. Click **Add a Rule**.
13. Select **SIP** for the condition
14. Enter **6501234*** for Caller ID.
15. Enter a **percentage** for amount the traffic you want to be affected by SIP flow sampling.
16. Click **OK**.

Create the SIP whitelist

1. From the device view, select **GigaSMART > Whitelist**.
2. Click **New**.
3. Type an **alias** in the Alias field.
4. From the GigaSMART Groups drop-down list, select a .the GigaSMART group.
5. Load whitelist files from a specified location to populate the SIP whitelist.
 - a. On the SIP Whitelist page, select **Bulk Upload**.
 - b. Select **Bulk Entry Operation** for **Upload Type**
 - c. Select Upload from URL from the Bulk Upload Type list.
 - d. Enter the **URL** in the **Enter Remote URL field**.
6. Click **OK**.

Associate the GigaSMART group to the SIP whitelist.

1. From the device view, select **GigaSMART > GigaSMART Groups > GigaSMART Groups**.
2. Select the **GigaSMART Group** you previously created and click **Edit**.
3. From the **GigaSMART Groups drop-down list**, select a GigaSMART group previously created.
4. Under **SIP Whitelist**, click on the **SIP Whitelist Alias field** and select the **alias** previously created from the available list.
5. Click **OK**.

Configure GigaSMART operation for SIP whitelisting

1. From the device view, select **GigaSMART > GigaSMART Operations > GigaSMART Operation**.
2. Click **New**.
3. Type an **alias** in the Alias field.
4. Select the GigaSMART group created in task 1.
5. From the GigaSMART Operations (GSOP) drop-down list, select the following:
 - **SIP Whitelist** and select **Enabled**.
 - **Load Balancing**.
6. For Load Balancing, do the following:
 - a. Choose: **Stateful**
 - b. For Type select: **SIP**
7. Click **OK**.

Configure first level map

1. Select **Maps > Maps > Maps**.
2. Click **New**.
3. Configure the map:
 - a. Enter an **Alias**
 - b. Type: **First Level**, Sub Type: **By Rule**
 - c. Source: **1/1/g2**
 - d. Destination: **vport**
4. Click **Add a Rule**.
5. Click **Save**.

Create another second level map for SIP flow whitelist

1. Select **Maps > Maps > Maps**.
2. Click **New**.
3. Configure the map:
 - a. Alias: **alias name**
 - b. Type: **Second Level**, Sub Type: **Flow Whitelist SIP**
 - c. Source: **vport1**
 - d. Destination: **1/2x23**
 - e. Select from the **GSOP** list.
4. Click **Add a Rule**.
5. Select SIP. In SIP type, you can choose any of the following options:
 - Caller ID
 - Callee ID
 - Caller/Callee ID
 - Source IP
 - Destination IP
 - Source/Destination IP
 - All
6. Click **OK**.

Display SIP/RTP Reports

To display SIP report, do the following:

1. From the device view, select GigaSMART > **GigaSMART Groups > Report**.
2. Select Group Type: **Flow SIP**.
3. From the device view, select GigaSMART Group: **gsg1**
4. Specify **Caller ID Pattern**.
5. Select Any. This return any pattern specified in the Caller ID Pattern field.

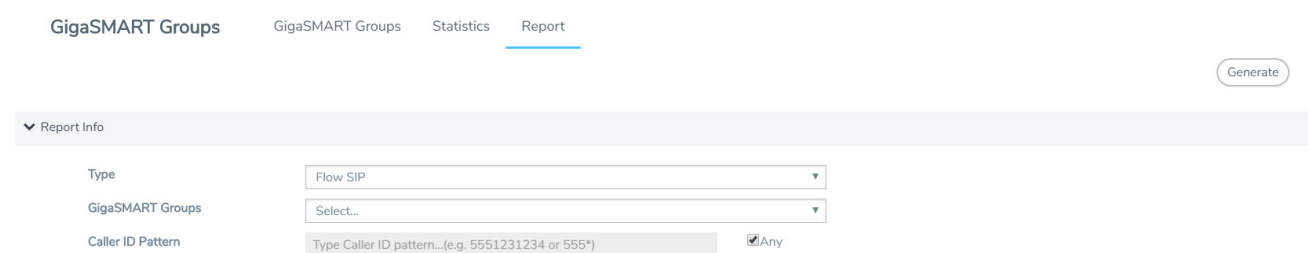


Figure 382: Generate SIP Report

6. Click the Generate button. The SIP Messages Report displays.

SIP	Total Pass	No Session	No Rule	No Match	Drop	Other
ACK	0	0	0	0	0	0
BYE	0	0	0	0	0	0
CANCEL	0	0	0	0	0	0
INFO	0	0	0	0	0	0
INVITE	0	0	0	0	0	0
MESSAGE	0	0	0	0	0	0
NOTIFY	0	0	0	0	0	0
OPTIONS	0	0	0	0	0	0
PRACK	0	0	0	0	0	0

Figure 383: SIP Report Page

Display SIP Map Statistics

Map Statistics displays the counts sessions that matched a particular map.

For SIP Flow Sample maps, the counters show how many sessions matched the Caller-ID rule and were either accepted or rejected based on the sampling percentage.

For SIP Whitelist maps, the counter shows how many total entries are in the Whitelist and how many sessions matched those entries. .

To display SIP Map Statistics, do the following:

- Select **Maps > Statistics**. The Statistics page displays a count of the rules that actually matched in a map.

Map Alias	Total Counters	Rules
map-sip-1	0 Packets, 0 Bytes	2
map-sip-2	0 Accepted, 0 Rejected, 0 Matched	2
map-sip-3	0 Matched, 2 Entries	2

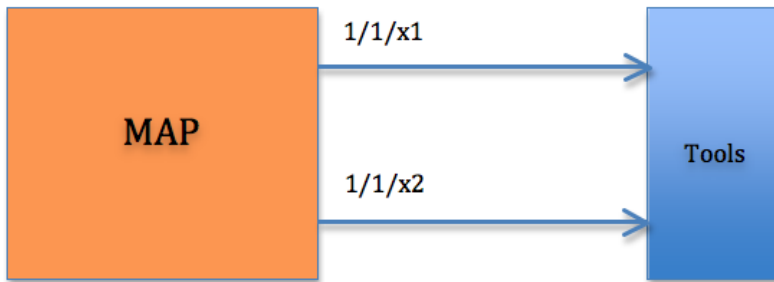
Total Items : 3

Figure 384: SIP Map Statistics

SIP/RTP Support for Tool Throttling

GigaSMART supports sampling/scaling based on fixed percentages, which remain in effect at all times, regardless of the tool port utilization. However, tool utilization may not be as efficient as not using fixed percentage for every use case. Starting with GigaSMART version 5.4 support for throttling sessions based on the traffic (pps) reaching a tool port is available. This feature helps avoid packets being drops during peak times by allowing users to adjust throttling start and stop levels.

The illustration below is a configuration and Intra Flow for Tool Port Throttling.



Admission Control

Each SIP session comes with RTP streams and each of the RTP stream uses a specific codec for information transfer. We can use this codec information to our advantage and do predictive analysis on how much pps would be generated for a given SIP session.

Based on the outcome of the pps for a given RTP stream codec, admission control module will check this value against the cumulative packet throughput on the destination tool-port to decide if the session will be Accepted or Rejected.

Example: Tool port 1/1/x1 is configured with a threshold of 3k pps.

Time	Port	Session	Codec (pps)	Cumulative pps	Throttle pps	Accepted
t0	1/1/x1	0		0	3000	
t1	1/1/x1	1	500	500	3000	Yes
t2	1/1/x1	2	1500	2000	3000	Yes
t3	1/1/x1	3	800	2800	3000	Yes
t4	1/1/x1	4	500	3300	3000	No

In software version 5.4 Tool port throttling applies only to SIP sessions for audio and only load balanced ports are supported in tool port throttling. Use case where there are tapping multiple interfaces using multiple engines, one SIP session can be throttled in one engine and not in another.

GigaSMART FlowVUE

Required License: FlowVUE

GigaSMART FlowVUE supports the following:

- flow-aware sampling of subscriber devices to filter and forward all flows sourced from a sampled set of subscriber device IPs
- flexible sampling on subscriber IPs and IP ranges, and at specified sampling rates
- user-configurable timeouts to detect and replace inactive devices
- IP-based sampling of flows and IP-based flows encapsulated in GTP-u tunnels

FlowVUE offers subscriber IP-based flow sampling that helps carriers turn Big Data into manageable data. The GigaSMART application enables existing tools to connect to the latest high-speed pipes by providing a representative view of traffic for diagnostic coverage. GPRS Tunneling Protocol (GTP) is commonly used to carry mobile data across service provider networks and includes the control plane (GTP-c) and a user-data plane (GTP-u) traffic. FlowVUE allows for active sampling of a subscriber's device (known as a user endpoint IP or UE IP) across GTP-u tunnels. The integrity of the subscriber flows is preserved by forwarding all the flows associated with the sampled UE IP to the monitoring and analytic tools.

In contrast, traditional methods randomly sample packets without any correlation to the flows. This provides limited visibility into subscriber behavior and experience. FlowVUE intelligently reduces the amount of traffic, while keeping the integrity of the data flows intact, but at a lower speed feed within a smaller pipe.

Leveraging FlowVUE, providers can enhance quality of experience (QoE) monitoring by forwarding all of the control plane traffic to the tools infrastructure and only perform intelligent user-plane sampling (a configurable percentage of UE IPs) to get a representative view of application usage.

When combined with the advanced filtering capabilities of GigaSMART Adaptive Packet Filtering (APF), operators can further filter, replicate, and forward specific traffic flows of interest based on application ports and packet content-based payloads for all or a subset of the sampled subscribers. This further reduces the volume of traffic to the tool infrastructure. The ability to sample a subset of subscriber devices and transmit all the associated sessions of interest to the monitoring tools, reduces the amount of data while enabling Big Data throughput processing, with existing cost structures.

FlowVUE operations can be assigned to GigaSMART groups consisting of multiple engine ports. Refer to [Groups of GigaSMART Engine Ports](#) for details.

Configure FlowVUE

The GigaSMART parameters for configuring FlowVUE are as follows:

- flow-sampling-device-ip-ranges—Specifies the range of IP addresses that identify a valid device.
- flow-sampling-rate—Specifies how much GTP traffic from subscribers in the specified IP ranges is sampled. The values range from 5 to 95%.
- flow-sampling-timeout—Specifies after how much time a flow/device in a sampled IP range is declared idle and is no longer sampled. The values range from 1 to 60 minutes.
- flow-sampling-type—Specifies whether inner or outer IP addresses are used for FlowVUE sampling as follows:
 - device-ip—Specifies a sample subset of devices based on IP address.
 - device-ip-in-gtp—Specifies a sample subset of devices based on inner IP address in the GTP-u tunnel.

Sample a Subset of Subscribers and Sample all Subscribers Traffic

The following example samples on GTP-u traffic where 10% of the subscribers are forwarded.

Task	Description	UI Steps
1	Configure one network and two tool type of ports.	<ol style="list-style-type: none"> 1. Select Ports > Ports > All Ports. 2. Click Quick Port Editor. 3. Configure one network port and two tool ports. For example, select Network for port 1/1/x3. Select Tool for port 1/1/x4 and port 1/1/x1. 4. Select Enable for each port. 5. Click OK. 6. Close the Quick Port Editor.
2	Configure a GigaSMART group and associate it with a GigaSMART engine port and configure sampling parameters	<ol style="list-style-type: none"> 1. From the device view, select GigaSMART > GigaSMART Groups > GigaSMART Groups. 2. Click New. 3. Type gsg1 in the Alias field. 4. Click in the Port List field and select an engine port. For example. 1/1/e1. 5. Configure the Flow Sampling parameters under GigaSMART

Task	Description	UI Steps
		Parameters. <ul style="list-style-type: none"> • Select Device IP. • Enter 1.1.1.0/255.255.255.0 in the IP Ranges field. • Enter 10 for Rate to set the flow sampling rate to 10 percent. 6. Click Save.
3	Configure the GigaSMART operation and assign it to the GigaSMART group.	<ol style="list-style-type: none"> 1. From the device view, select GigaSMART > GigaSMART Operations (GSOP) > GigaSMART Operations. 2. Click New. 3. Type gsfvue in the Alias field. 4. Select gsg1 from the GigaSMART Groups list. 5. Select Flow Sampling from the GigaSMART Operations (GSOP) list. 6. Select Flow Sampling - IP 7. Click Save.
4	Create an ingress (first level) map. <div style="border: 1px solid #ccc; padding: 5px; margin-top: 10px;"> NOTE: In the rule, 2152 is GTP-u traffic. </div>	<ol style="list-style-type: none"> 1. Select Maps > Maps > Maps. 2. Click New. 3. Configure the map. <ul style="list-style-type: none"> • Enter to_tool in the Alias field. • Select Regular for Type. • Select By Rule for Subtype. • Select the network port for the Source. • Select a tool port for the Destination. • Select gsfvue from the GSOP list. 4. Add a rule. <ol style="list-style-type: none"> a. Click Add a Rule. b. Select Pass. c. Select Port Destination. d. Enter 2152 for the port value. 5. Click Save.

Sample a Subset of Subscribers and Sample a Subset of Traffic

FlowVUE can be used to reduce traffic to the monitoring tools. By combining FlowVUE with other GigaSMART applications such as APF, the traffic can be further reduced by filtering on specific Layer 4 application ports.

The following example samples on a subset of subscribers and forwards only the HTTP traffic related to the sampled subscriber set of devices.

Task	Description	UI Steps
1	Configure one network and two tool type of ports.	<ol style="list-style-type: none"> 1. Select Ports > Ports > All Ports. 2. Click Quick Port Editor. 3. Configure one network port and two tool ports. For example, select Network for port 1/1/x3. Select Tool for port 1/1/x4 and port 1/1/x1. 4. Select Enable for each port. 5. Click OK. 6. Close the Quick Port Editor.
2	Configure a GigaSMART group and associate it with a GigaSMART engine port.	<ol style="list-style-type: none"> 1. From the device view, select GigaSMART > GigaSMART Groups > GigaSMART Groups. 2. Click New. 3. Type gsg1 in the Alias field. 4. Click into the Port List field and select an engine port. For example, 1/1/e1. 5. Configure the Flow Sampling parameters under GigaSMART Parameters. <ul style="list-style-type: none"> • Select Device IP. • Enter 1.1.1.0/255.255.255.0 in the IP Ranges field. • Enter 10 for Rate to set the flow sampling rate to 10 percent. 6. Click Save.
3	Configure the GigaSMART operation and assign it to the GigaSMART group. Also, configure APF.	<ol style="list-style-type: none"> 1. From the device view, select GigaSMART > GigaSMART Operations (GSOP) > GigaSMART Operation. 2. Click New. 3. Type gsfvue_apf in the Alias field. 4. Select gsg1 from the GigaSMART Groups list. 5. Select APF from the GigaSMART Operations (GSOP) list 6. Enable APF.

Task	Description	UI Steps
		<ol style="list-style-type: none"> Click Save.
4	Configure virtual port and associate it with the GigaSMART group.	<ol style="list-style-type: none"> From the device view, select GigaSMART > Virtual ports. Click New. Enter vp1 in the Alias field. Select gsg1 from the GigaSMART Groups list. Click Save.
5	<p>Create a first level map and direct traffic to the virtual port.</p> <div data-bbox="272 632 737 688" style="border: 1px solid #ccc; padding: 5px; background-color: #f0f8ff;"> <p>NOTE: In the rule, 2152 is GTP-u traffic.</p> </div>	<ol style="list-style-type: none"> Select Maps > Maps > Maps. Click New. Configure the map. <ul style="list-style-type: none"> Enter to_vp in the Alias field. Select First Level for Type. Select By Rule for Subtype. Select the network port for the Source. Select the virtual port vp1 for the Destination. Select gsfvue from the GSOP list. Add a rule. <ol style="list-style-type: none"> Click Add a Rule. Select Pass. Select Port Source. Enter 2152 for the port value. Click Save.
6	Create a second level map and use the APF GigaSMART operation. APF performs filtering according to the gsrules, sending only matching traffic to the tool port.	<ol style="list-style-type: none"> Select Maps > Maps > Maps. Click New. Configure the map. <ul style="list-style-type: none"> Enter map1 in the Alias field. Select Second Level for Type. Select By Rule for Subtype. Select the virtual port vp1 for the Source. Select the a tool port for the Destination. Select gsfvue_apf from the GSOP list. Add a rule 1. <ol style="list-style-type: none"> Click Add a Rule. Select Pass.

Task	Description	UI Steps
		<ul style="list-style-type: none"> c. Select Port Destination. d. Enter 80 for the port value. e. Select 2 for Position. <p>6. Add a rule 2.</p> <ul style="list-style-type: none"> a. Click Add a Rule. b. Select Pass. c. Select Port Source. d. Enter 80 for the port value. e. Select 2 for Position. <p>6. Click Save.</p>

Display FlowVUE Statistics

To display FlowVUE statistics, select **GigaSMART > GigaSMART Operations (GSOP) > Statistics**.

Refer to [FlowVUE Statistics Definitions](#) for descriptions of these statistics as well as to [GigaSMART Operations Statistics Definitions](#).

GigaSMART GTP Whitelisting and GTP Flow Sampling

Required Licenses: GTP Filtering & Correlation and FlowVUE

Use GTP whitelisting and GTP flow sampling to provide subsets of GTP correlated flows to tools. GTP whitelisting selects specific subscribers based on IMSI, while GTP flow sampling uses map rules to select subscribers. Starting in software version 4.8, GigaSMART supports GTP overlap mapping, which combines both whitelisting and flow sampling maps as part of a map group. Refer to [GTP Overlap Flow Sampling Maps](#)

Starting in software version 4.5, a GigaSMART group (gsgroup) associated with GTP applications can have multiple GigaSMART engine port members (**e** ports), up to four, forming an engine group. Refer to [GTP Scaling](#).

Refer to the following sections:

- [GTP Whitelisting](#)
- [GTP Flow Sampling](#)
- [GigaSMART GTP Whitelisting and GTP Flow Sampling](#)

GTP Whitelisting

GTP whitelisting selects specific subscribers based on IMSI. The whitelist contains up to 500,000 subscriber IMSIs. For subscribers in the whitelist, 100% of their traffic is always sent to a specified tool port.

For example, when a subscriber session comes in, GTP whitelisting checks the IMSI of the subscriber. If the incoming IMSI matches an IMSI in the whitelist, the session is sent to the tool port or load balancing group specified in the whitelist map.

Starting in software version 4.7, GTP whitelisting is supported in a cluster. Refer to [GTP Whitelisting in a Cluster](#) for more information.

Create Whitelist

Subscriber IMSIs are added to a whitelist that can contain up to 500,000 subscriber IMSIs. One active whitelist per GigaSMART group is supported.

Entries in the whitelist can be added one at a time or whitelist files containing multiple IMSIs can be created and downloaded. Entries are added by using the GTP Whitelist page by selecting **GigaSMART > GTP Whitelist**. The GTP Whitelist page shows alias for the currently configured GTP Whitelists, the IMSI count for each Whitelist and the GigaSMART Group associated with the GTP Whitelist. The GTP Whitelist is associated with the GigaSMART group by specifying its alias in the **GTP Whitelist Alias** field in GigaSMART Group configuration page and then clicking **New**.

An individual IMSI is added by selecting Individual **Entry Operation** and specifying the IMSI in the **Individual IMSI Entry** field.

The IMSIs in whitelist files must be distinct entries, with one IMSI on each line of a file and a maximum of 20,000 entries in each file. This means that 25 files of 20,000 entries will be needed to populate the whitelist to its capacity. Wildcards are not supported in whitelist files.

Whitelist files must have a filename with a .txt suffix. Use the GTP Whitelist page to fetch the entries from a whitelist file at a specified location, using one of the following formats, which are specified in the **Enter Remote URL** field when **Bulk Entry Operation** is selected and the **Bulk Upload Type** is **Upload from URL**:

- http://IPaddress/path/filename.txt
- scp://username:password@IPaddress:/path/filename.txt
- tftp://IPaddress/path/filename.txt

To fetch a whitelist file from a local location, select **File Upload** for **Bulk Upload Type** and use the **Browse** button to select the file.

When a whitelist file is downloaded, the entries are compared to the whitelist on the node. There may be new entries in the file that might already be part of the existing whitelist. GigaSMART will add the new, non-duplicate entries to the whitelist, without rejecting the entire file.

If the current number of entries in the whitelist plus the new entries in the whitelist file is greater than the whitelist capacity of 500,000 IMSIs, the **Append** operation will fail and the new entry or the entries from the new whitelist file will not be added.

GTP whitelisting does not use map rules like GTP flow sampling does. The whitelist is associated with a GigaSMART group, GigaSMART operation, and second level maps, called whitelist maps.

You can create multiple whitelists, each with 500,000 IMSIs. However, even though you can create multiple whitelists, you can only have one active whitelist in use at a time in a GigaSMART group, a GigaSMART operation, and whitelist maps. To switch from one whitelist to another, you must first either delete or destroy the currently active whitelist before you can make another whitelist active. Refer to [Delete Whitelist](#).

For the sequences of steps to create a whitelist with the UI, refer to the configuration example for whitelisting in [Example 1: GTP Whitelisting](#).

Configure Whitelist Maps

The whitelist maps are configured per GigaSMART group. Each whitelist map, associated with the same vport, uses the same underlying whitelist.

Up to ten (10) whitelist maps are supported. Multiple whitelist maps provide a granular selection of tool ports for whitelisting. Using multiple maps, traffic can be segregated and sent to multiple destinations. Whitelist map rules allow you to select the subset of IMSIs sent to a particular tool.

Each whitelist map can contain up to four rules. The rules specify the type of traffic to be whitelisted by that map. Within any single map, the rules are evaluated in order. The rules in the first map have a higher priority than the rules in the second, third, and subsequent maps.

The rules will specify either an Evolved Packet Core (EPC) interface type or a GTP version as the attribute to match. An Access Point Name (APN) can also be specified in a rule of a Second Level Flow Whitelist map, either by itself, or preceding the EPC interface type or in combination with the GTP version.

For APN, you must specify a pattern (a name) to match. Use APN to direct the traffic that matches the pattern to a specific tool.

GTP version and EPC interface are mutually exclusive. A mix of versions and interface types across whitelist maps, associated with the same vport, is not supported. For example, you can configure two whitelist maps with one map specifying a rule for version 1 and another map specifying a rule for version 2, OR four whitelist maps with each map specifying a rule for each interface type (Gn, S11, S5, and S10). For more information on interfaces, refer to [Supported Interfaces](#).

An APN pattern is for example, three.co.uk. Wildcard prefixes and suffixes are supported, for example, *mobile.com or *ims*. The pattern can be specified in up to 100 case-insensitive alphanumeric characters and can include the following special characters: period (.), hyphen (-), and wildcard (*). A standalone wildcard (*) is not allowed for APN.

NOTE: APN is not supported on GigaVUE-HB1.

Each new subscriber session will be evaluated by the whitelist maps in the order of priority, which, by default, is the order in which the maps were created.

When a subscriber session comes in, GTP whitelisting will check the IMSI of the subscriber. If the IMSI is present in the whitelist, the rules in the first whitelist map is evaluated to qualify the match further. Otherwise, the packet is evaluated against the rules in the subsequent whitelist maps for a possible match.

For example, with one whitelist map having a rule specifying GTP version 1 and another whitelist map having a rule specifying GTP version 2, when a subscriber session comes in, GTP whitelisting will check the IMSI of the subscriber. If the IMSI is present in the whitelist and if there is a match to version 1, the session (100% of subscriber packets) will be forwarded to the tool port, GigaStream, or load balancing group specified in the whitelist map. If there is not a match to version 1, the next map is evaluated. If there is a match to version 2 in the next map, the session will be forwarded to the tool port, GigaStream, or load balancing group specified in the second whitelist map.

NOTE: Both maps can specify the same destination.

Rules can be added to, or deleted from, a whitelist map. Use the **Add a Rule** button to add a new whitelist rule (a pass rule). Click **x** to delete a rule. A rule in a whitelist map cannot be edited. To edit a rule, first delete it, then recreate it.

The default map configuration in which neither GTP version, EPC interface, or APN is specified in the map, continues to be supported. If the incoming IMSI matches an IMSI in the whitelist, the session will be sent to the tool port, GigaStream, or load balancing group specified in the whitelist map.

Whitelist maps cannot contain any other rules such as GigaSMART rules (gsrule), flow filtering rules (flowrule), or flow sampling rules (flowsample).

GTP whitelist-based forwarding is performed prior to GTP flow sampling (rule-based flow sampling) and GTP flow filtering.

NOTE: For GTP second level maps, a maximum of fifteen maps can be attached to a vport. For example, for the same vport you can have five whitelist maps and ten flow sampling maps, or ten whitelist maps, four flow sampling maps, and one flow filtering map. In addition, you can have a collector map, which is not counted.

For the steps to create a whitelist map with the UI, refer to the configuration example for whitelisting in [GTP Whitelisting and GTP Flow Sampling Examples](#).

Change Priority of Whitelist Maps

Use the **Priority** field in the map to change the priority of whitelist maps.

Delete Whitelist Maps

When a whitelist map is deleted, the priority of the remaining whitelist maps will be re-prioritized. For example, if the first whitelist map is deleted, the second whitelist map will increase in priority.

For the deleted whitelist map, the traffic associated with the rules in the map will be reevaluated and then passed to subsequent maps.

When a whitelist map is re-prioritized, the existing sessions will be reevaluated according to the new priority of the map. The traffic associated with the rules in the map will be reevaluated and then passed to subsequent maps.

When the last whitelist map is deleted, the traffic associated with the rules in the map will also be reevaluated before being passed to subsequent maps. But the traffic associated with the rules in maps that were not matched, will not be reevaluated because that traffic was already passed to subsequent maps.

Apply Whitelist

When a single whitelist entry is added, whitelisting is applied for new as well as existing subscribers. When a new whitelist file is fetched, whitelisting is applied only for new subscribers.

Whitelisted traffic is then sent to the port or load balancing group specified in the whitelist map.

Delete Entry from Whitelist

Entries in the whitelist can be deleted one at a time. Each entry is a single IMSI.

When a whitelist entry is deleted, the session associated with the whitelist entry stays active and traffic is still sent to the whitelist map. The whitelist session will not be reevaluated or passed to subsequent maps.

To delete a single entry from the whitelist, select **Individual Entry Operation**, set **Remove** as the **Operation Type**, and enter the IMSI in the **Individual IMSI Entry** field.

Delete Multiple Entries from Whitelist

Multiple IMSIs can be deleted from the whitelist. Specify the IMSIs to be deleted in a whitelist file, which can contain up to 20,000 IMSIs.

Whitelist files must have a filename with a .txt suffix. To remove multiple entries from the whitelist, select **Bulk Entry Operation** and set **Remove** as the **Operation Type**.

Delete Whitelist

The entire whitelist can be deleted using one of the following two options:

- Delete the whitelist by deleting all the IMSI entries. With this option, you do not have to delete the whitelist map, GigaSMART operation, or disassociate the GigaSMART group from the whitelist. To delete all the IMSI entries, select **Delete All**.
- Destroy the whitelist. With this option, you must first delete the whitelist map, GigaSMART operation, and disassociate the GigaSMART group from the whitelist before deleting the whitelist.

Destroy Whitelist

To destroy a whitelist, use the following sequence:

Task	UI Steps
Delete the whitelist map	<ol style="list-style-type: none"> 1. Select Maps > Maps > Map. 2. Select the whitelist map. 3. Click Delete.
Delete the GigaSMART Operation	<ol style="list-style-type: none"> 1. From the device view, select GigaSMART > GigaSMART Operation(s) > GigaSMART Operation. 2. Select the GigaSMART Operation. 3. Click Delete.
Disassociate the GigaSMART group from the whitelist. (You do not need to delete the GigaSMART group.)	<ol style="list-style-type: none"> 1. From the device view, select GigaSMART > GigaSMART Groups > GigaSMART Groups. 2. Select the GigaSMART group. 3. Click Edit.

Task	UI Steps
	<ol style="list-style-type: none"> 4. Under GigaSMART Parameters, go the GTP Whitelist and set GTP Whitelist Alias to None.
Destroy (delete) the whitelist	<ol style="list-style-type: none"> 1. From the device view, select GigaSMART > GigaSMART GTP Whitelist. 2. Select the GTP Whitelist. 3. Click Delete.

GTP Whitelisting in a Cluster

The whitelist (all whitelist files) must reside on the master node of the cluster. The non-master nodes receive a copy of the whitelist from the master. Updates to the whitelist are synchronized from the master to the non-master nodes. If a non-master node leaves the cluster and rejoins, its whitelist will be resynchronized.

GigaVUE-HB1 nodes do not support GTP whitelisting in a cluster due to their limited storage. If there are GigaVUE TA Series nodes in the cluster, they will not receive a copy of the whitelist.

GTP Flow Sampling

GTP flow sampling samples a configured percentage of GTP sessions. GTP flow sampling uses map rules to select subscribers and then forward a percentage of the packets to tool ports.

Pass rules are defined in flow sampling maps. Each rule contains some combination of IMSI, IMEI, and MSISDN numbers or patterns, Evolved Packet Core (EPC) interface type, GTP version, Access Point Name (APN), or QoS Class Identifier (QCI), as well as a percentage to sample. The flow is sampled to see if it matches a rule. The percentage of the subscriber sessions matching each rule are selected.

Map rules specify the type of traffic to be flow sampled by that map. For each new session, map rules are evaluated in top-down order of decreasing priority. If there is a match, the indicated percentage of the subscriber session is either accepted or rejected. If accepted, the traffic is sent to the tool port or load balancing group specified in the map. If rejected, the traffic is dropped. If there is not a match to a rule, the traffic is passed to subsequent maps.

Starting in software version 4.6, GTP load balancing in a cluster is supported for GTP flow sampling. For an example of GTP load balancing in a cluster, refer to [GTP Whitelisting and GTP Flow Sampling Examples](#).

About Flow Sampling Rules and Maps

Flow sampling rules are configured in maps called flow sampling maps. Up to ten (10) flow sampling maps per GigaSMART group are supported. Each flow sampling map supports up to 20 flow sampling rules, for a maximum of 200 rules per GigaSMART group.

GTP flow sampling (rule-based flow sampling) is performed after GTP whitelist-based forwarding but before GTP flow filtering. So, flow sampling maps have a priority lower than whitelist maps and higher than flow filtering maps.

NOTE: For GTP second level maps, a maximum of fifteen maps can be attached to a vport. For example, for the same vport you can have one whitelist map and ten flow sampling maps, or ten whitelist map, four flow sampling maps, and one flow filtering map. In addition, you can have a collector map, which is not counted.

In the flow sampling maps, the rules in the first map have a higher priority than the rules in the second, third, and subsequent maps. Within any single map, rules are evaluated in order.

Rules can be added to, deleted from, or inserted into a flow sampling map when the subtype selected for a **Second Level** map is **Flow Sample**. Suffix wildcarding, such as IMSI 100*, is supported in the flow sampling map rules.

Use the **Add a Rule** button in the Maps page to add a new flow sampling rule (a pass rule). Specify IMSI, IMEI, or MSISDN subscriber IDs, as well as the percentage of the flow to be sampled. The percentage is a range from 1 to 100%. Use 0% to drop sampled data.

A rule can specify other packet attributes, such as an EPC interface type or GTP version. An APN pattern can also be specified in a rule, either by itself or preceding the EPC interface or GTP version. A QCI value can be specified, but only in combination with an APN pattern.

EPC interface and GTP version are mutually exclusive. They can be specified in a flow sampling rule, but not both in a single rule. The supported interface types for filtering are: Gn/Gp, S11/S1-U, S5/S8, S10, or S2B. The supported versions for filtering are 1 or 2. For example, you can send version 1 traffic to one tool port and version 2 traffic to another tool port. For more information on interfaces, refer to [Supported Interfaces](#).

For APN, specify a pattern (a name) to match, for example, three.co.uk. Wildcard prefixes and suffixes are supported, for example, *mobile.com or *ims*. The pattern can be specified in up to 100 case-insensitive alphanumeric characters and can include the following special characters: period (.), hyphen (-), and wildcard (*).

NOTE: APN is not supported on GigaVUE-HB1.

QCI is a mechanism used in Long Term Evolution (LTE) networks to ensure bearer traffic is allocated to the appropriate Quality of Service (QoS). For QCI, specify a value from 0 to 255. Wildcard prefixes and suffixes are not supported.

Use APN and QCI to send traffic that matches a certain APN pattern or that belongs to a certain bearer with a certain QCI to specified tool ports, based on the sampling percentage.

Click the **x** next to a rule to delete a specific rule. Rules are identified by a priority ID, which indicates the order of rules in a flow sampling map. For example, if a map has 12 pass flow sampling rules, there will be 12 priority IDs.

When creating Flow Sampling rules on the Maps page, the first rule created has the highest priority and the priority of subsequent rules is in the order that they are added. To change the priority of a Flow Sampling rule in a new map, do the following:

1. **Save** the rule.
2. Select the map and click **Edit**.
3. Enter a priority in the **Priority** field of each rule to order the rules in the map. (For details about map priority, refer to [Map Priority](#))

NOTE: A flow sampling map can contain only flowsampling rules. A flow sampling map cannot contain other GigaSMART rules (gsrule) or flow filtering rules (flowrule).

For configuration examples for flow sampling, refer to [GTP Whitelisting and GTP Flow Sampling Examples](#).

Add Rule to Flow Sampling Map

Flow sampling is applied for new subscribers. When a new rule is added to the rules in a flow sampling map, traffic will be sent to the port or load balancing group specified in the map.

Delete Rule from a Flow Sampling Map

When a rule is deleted from a flow sampling map, the session associated with the rule stays active. The traffic associated with the rule will not be reevaluated by subsequent maps.

Change Priority of Flow Sampling Maps

Use the **Priority** field in the GTP map rule to set the priority of flow sampling maps.

Delete Flow Sampling Map

When a flow sampling map is deleted, the priority of the remaining flow sampling maps will be re-prioritized. For example, if the first flow sampling map is deleted, the second flow sampling map will increase in priority.

For the deleted flow sampling map, the traffic associated with the rules in the map will be reevaluated and then passed to subsequent maps.

When a flow sampling map is re-prioritized, the existing sessions will be reevaluated according to the new priority of the map. The traffic associated with the rules in the map will be reevaluated and then passed to subsequent maps.

When the last flow sampling map is deleted, the traffic associated with the rules in the map will also be reevaluated before being passed to subsequent maps. But the traffic associated with the rules in maps that were not matched, will not be reevaluated because that traffic was already passed to subsequent maps.

Flow-Ops Report Limitation for Multiple Flow Sampling Maps

The flow-ops report displays the flow sampling rule ID for sessions that have been accepted or rejected by the flow sampling map.

However, since rule IDs are not unique across maps, when there are multiple flow sampling maps, the flow-ops report is unable to identify the exact rule that the session matched. For example, with multiple flow sampling maps, each map can have a rule ID of 1. The rule ID will be identified in the flow-ops report, but not the map associated with it.

GTP Flow Sampling Percentage

The sampling Percentage field in a map for GTP flow sampling, represents the percentage of subscribers that will be sampled (not the sessions).

The GTP correlation engine tracks all of the subscribers and all of their sessions that it sees on the network. In this example, for those subscribers with an IMSI starting with the value 46*, the GTP correlation engine keeps a list of them and randomly selects 80% of those subscribers and sets them to be in the sample, which means that a tool port (or load balanced group) will see 100% of the packets for 100% of the sessions for those randomly selected 80% of subscribers.

For the other 20% of subscribers, the GTP correlation engine continuously tracks those subscribers through the network, but does not send any packets to the tool port (or load balanced group).

Refer to the GTP flow sampling configuration examples in [GTP Whitelisting and GTP Flow Sampling Examples](#).

Drop Unmatched Traffic

When a session matches one of the configured flow sampling rules, it is either accepted for sampling or rejected.

If it is accepted, all packets belonging to that GTP session are sent to the tool port or ports specified in the flow sampling maps. If a subscriber is in the sample, then both the control plane packets and the user-data plane packets are sent to the tools.

If it is rejected, all packets belonging to the session are dropped. If the subscriber is not in the sample, then neither the control plane packets nor the user-data plane packets are sent to the tools.

Control plane (GTP-c) and user-data plane (GTP-u) traffic are treated the same. For a matching session, all the control plane and user-data plane traffic will be accepted. Otherwise, all the control plane and user-data plane traffic will be rejected and dropped. Instead, to enable or disable GTP control plane traffic sampling, refer to [Enable or Disable GTP Control Plane Traffic Sampling](#).

Enable or Disable GTP Control Plane Traffic Sampling

GTP control plane (GTP-c) traffic is typically a small percentage of total GTP traffic, but it contains useful information for analytics. Therefore, it is not always expedient to drop control plane traffic for sampled sessions.

Subscriber traffic by IMSI can be sampled such that network traffic for a subset of mobile subscribers can be selected to be sent to network monitoring tools. In some cases, network monitoring tools will want to see GTP control plane and GTP user plane traffic for a percentage of the subscribers. In other cases, network monitoring tools will want to see all of the GTP control plane traffic, but see only the GTP user plane traffic for the sampled percentage of subscribers.

Starting in software version 4.5, all control plane traffic for all subscribers will be sent to tools if GTP control plane traffic sampling is disabled. When disabled, 100% of the control traffic that matches any of the flow sampling rules will be sent to the tool ports specified in the flow sampling maps. Control traffic for both accepted and rejected sessions will be sent to the tool ports.

When GTP control plane traffic sampling is enabled, GTP-c packets will be sampled and only the indicated percentage of the control traffic that matches any of the flow sampling rules will be sent to the tool ports specified in the flow sampling maps, as described in [GTP Flow Sampling Percentage](#).

The default is enable.

To disable sampling of GTP-c traffic, which enables 100% of control plane traffic, select **GigaSMART > GigaSMART Groups > GigaSMART Groups**. Under GigaSMART Parameters, go to **GTP Sampling** and make sure that **GTP Control Sampling** is not selected.

To enable sampling of GTP-c traffic, which enables 100% of control plane traffic, select **GigaSMART > GigaSMART Groups > GigaSMART Groups**. Under GigaSMART Parameters, go to **GTP Sampling** and make sure that **GTP Control Sampling** is selected. This setting applies to all the flow sampling maps for a GigaSMART group.

GTP Subscriber Aware Random Sampling

GTP Subscriber Aware Random Sampling allows to randomly sample all the subscriber's IMSI on a rotational basis. Based on the configured sampling percentage, the selected sessions are either sampled in or out. The correlation engine takes the configurable interval as an input to rotate the random selection of each of the subscriber's sessions.

The configurable interval is a minimum of 12 hours and a maximum of 48 hours. Each GigaSMART node must be synchronized with an NTP/PTP server, as UTC time is involved in the random selection of the subscriber's sessions.

NOTE: This feature is effective for a new subscriber's sessions after enabling the random sampling.

The Map rules in the GTP random sampling are similar to GTP Flow Sampling. For more information refer to [GigaSMART GTP Whitelisting and GTP Flow Sampling](#).

To enable GTP Random Sampling do the following:

1. Select **GigaSMART > GigaSMART Groups**.
2. Select a GigaSMART Group and click **Edit**.
3. Under GigaSMART Parameters, go to **GTP** and select **GTP Random Sampling** check box.
4. Enter the time in **Rotation Interval in multiples of 12 hours**.
5. Click **OK**.

GTP Whitelisting and GTP Flow Sampling Examples

Refer to the following examples:

- [Example 1: GTP Whitelisting](#)
- [Example 2: GTP Whitelisting with Multiple Maps](#)
- [Example 3: GTP Flow Sampling](#)

- [Example 4: GTP Whitelisting, GTP Flow Sampling, and Load Balancing](#)
- [Example 5: GTP Flow Sampling with Multiple Maps](#)
- [Example 6: APN for GTP Whitelisting, GTP Flow Sampling](#)
- [Example 7: APN for FTP Whitelisting, APN and QCI for GTP Flow Sampling](#)

Example 1: GTP Whitelisting

Example 1 is a GTP whitelisting configuration example. Traffic from network ports go to the three first level maps (GTP-Control, GTP-User, and Fragments-Not_First) and then to the virtual port (vport1). If there is a match to an IMSI in the whitelist (MyIMSI), it is forwarded to a port.

Task	Description	UI Steps
1.	Configure a GigaSMART group and associate it with a GigaSMART engine port.	<ol style="list-style-type: none"> a. From the device view, select GigaSMART > GigaSMART Groups. b. Click New. c. Type an alias in the Alias field and enter an engine port in the Port List field. d. Click Save.
2.	Create a virtual port.	<ol style="list-style-type: none"> a. From the device view, select GigaSMART > Virtual Ports. b. Click New. c. Type an alias in the Alias field and enter an engine port in the Port List field. d. From the GigaSMART Groups drop-down list, select the GigaSMART group created in task 1. e. Click Save.
3.	Create the GTP whitelist.	<ol style="list-style-type: none"> a. From the device view, select GigaSMART > GTP Whitelist. b. Click New. c. Type an alias in the Alias field. d. From the GigaSMART Groups drop-down list, select the GigaSMART group created in Task 1. e. Go to Task 4.
4.	Fetch whitelist files from a specified location to populate the GTP whitelist.	<ol style="list-style-type: none"> a. On the GTP Whitelist page, select Bulk Upload. b. Select Bulk Entry Operation for IMSI Upload Type

Task	Description	UI Steps
		<ul style="list-style-type: none"> c. Select Upload from URL from the Bulk Upload Type list. d. Enter the URL in the Enter Remote URL field. For example, http://10.1.1.100/t-ftpboot/myfiles/MyIMSI_file2.tx e. Click Save.
5	Associate the GigaSMART group to the GTP whitelist.	<ul style="list-style-type: none"> a. From the device view, select GigaSMART > GigaSMART Groups. b. Select the GigaSMART Group created in Task 1 and click Edit. c. Type an alias in the Alias field. d. From the GigaSMART Groups drop-down list, select the GigaSMART group created in task 1. e. Under GTP Whitelist, click on the GTP Whitelist Alias field and select the alias from Task 3. f. Click Save.

Task	Description	UI Steps
6.	Configure the GigaSMART operation for GTP whitelisting.	<ol style="list-style-type: none"> a. From the device view, select GigaSMART > GigaSMART Operations > GigaSMART Operation. b. Click New. c. Type an alias in the Alias field. For example, GTP-Whitelist. d. Select the GigaSMART group created in task 1. e. From the GigaSMART Operations (GSOP) drop-down list, select the following: <ul style="list-style-type: none"> • GTP Whitelist and select Enabled. • Load Balancing. f. For Load Balancing, do the following: <ul style="list-style-type: none"> • Choose Stateful • For Type select GTP c. Choose Hashing for the metric and select IMSI d. Click Save.
7.	Configure three first level maps. <div data-bbox="272 1136 657 1220" style="border: 1px solid black; padding: 5px; margin-top: 10px;"> <p>NOTE: In the rules, 2123 is GTP-c traffic and 2152 is GTP-u traffic.</p> </div>	<ol style="list-style-type: none"> a. Configure the first map as follows: <ul style="list-style-type: none"> • Alias: GTP-Control • Type and subtype: First Level By Rule • Source: network port or ports • Destination: virtual port created in Task 2. • Rule: Pass, Bi Directional, Port Destination 2123 • Map Permissions: Select current user's group for Owner • Save the map b. Configure the second map as follows: <ul style="list-style-type: none"> • Alias: GTP-User • Type and subtype: First Level By Rule • Source: Same network port or ports as first map. • Destination: virtual port created in Task 2. • Rule: Pass, Bi Directional, Port Destination 2152

Task	Description	UI Steps
		<ul style="list-style-type: none"> • Map Permissions: Select current user's group for Owner • Save the map <p>h. Configure the third map as follows:</p> <ul style="list-style-type: none"> • Alias: Fragments-Not-First • Type and subtype: First Level By Rule • Source: Same network port or ports as first map • Destination: virtual port created in Task 2 • Rule: Pass, IPv4 Fragmentation and select allFragNoFirst • Map Permissions: Select current user's group for Owner. • Save the map
8.	Configure a second level map for GTP whitelisting, the whitelist map. If there is a match to an IMSI in the whitelist (MyIMSI), it is forwarded to a port.	<p>a. Configure the second level map as follows:</p> <ul style="list-style-type: none"> • Alias: GTP-Whitelist • Type and subtype: Second Level By Rule • Source: virtual port created in Task 2 • Destination: select a tool port • GSOP: GigaSMART Operation created in Task 6 • Map Permissions: Select current user's group for Owner <p>b. Click Save.</p>

Example 2: GTP Whitelisting with Multiple Maps

Example 2 is a GTP whitelisting configuration example that includes multiple GTP whitelisting maps, which provide a more granular selection of tool ports.

Traffic from network ports go to the three first level maps (GTP-Control, GTP-User, and Fragments-Not-First) and then to the virtual port (vport1). Two whitelist maps are configured. The first map specifies a rule for version 1 traffic. The second map specifies a rule for version 2 traffic.

Task	Description	UI Steps
1.	Configure a GigaSMART group and associate it with a GigaSMART engine port.	<ol style="list-style-type: none"> From the device view, select GigaSMART > GigaSMART Groups > GigaSMART Groups. Click New. Type an gsg1 in the Alias field and enter an engine port in the Port List field, for example 10/7/e1. Click Save.
2.	Create a virtual port.	<ol style="list-style-type: none"> From the device view, select GigaSMART > Virtual Ports. Click New. Type vport1 in the Alias field. From the GigaSMART Groups drop-down list, select the GigaSMART group created in task 1. Click Save.
3.	Create the GTP whitelist.	<ol style="list-style-type: none"> From the device view, select GigaSMART > GTP Whitelist. Click New. Type an MyIMSI in the Alias field. From the GigaSMART Groups drop-down list, select the GigaSMART group created in Task 1. Go to Task 4.
4.	Fetch whitelist files from a specified location to populate the GTP whitelist.	<ol style="list-style-type: none"> On the GTP Whitelist page, select Bulk Upload. Select Bulk Entry Operation for IMSI Upload Type Select Upload from URL from the Bulk Upload Type list. Enter the URL in the Enter Remote URL field. For example, http://10.1.1.100/t-ftpboot/myfiles/MyIMSI_file2.tx Click Save.
5.	Associate the GigaSMART group to the GTP whitelist.	<ol style="list-style-type: none"> From the device view, select GigaSMART > GigaSMART Groups > GigaSMART Groups. Select the GigaSMART Group created in Task 1 and click Edit. From the GigaSMART Groups drop-down list, select the GigaSMART group created in task 1.

Task	Description	UI Steps
		<ol style="list-style-type: none"> d. Under GTP Whitelist, click on the GTP Whitelist Alias field and select the alias from Task 3. e. Click Save.
5.	Configure the GigaSMART operation for GTP whitelisting.	<ol style="list-style-type: none"> a. From the device view, select GigaSMART > GigaSMART Operations > GigaSMART Operation. b. Click New. c. Type gtp-whitelist in the Alias field. d. Select the GigaSMART group created in task 1. e. From the GigaSMART Operations (GSOP) drop-down list, select the following: <ul style="list-style-type: none"> • GTP Whitelist and select Enabled. • Load Balancing. f. For Load Balancing, do the following: <ul style="list-style-type: none"> • Choose Stateful • For Type select GTP • Choose Hashing for the metric and select IMSI • Click Save.
6.	Configure three first level maps. <div style="border: 1px solid black; padding: 5px; margin-top: 10px;"> <p>NOTE: In the rules, 2123 is GTP-c traffic and 2152 is GTP-u traffic.</p> </div>	Configure the first map. <ol style="list-style-type: none"> a. Select Maps > Maps > Maps. b. Click New. c. Configure the map: <ul style="list-style-type: none"> • Alias: GTP-Control • Type: First Level, Sub Type: By Rule • Source: 8/1/x40, 8/1/x6 • Destination: vport1 d. Click Add a Rule. <ul style="list-style-type: none"> • Select Pass and Bi Directional • Select Port Destination for the rule • Set port value to 2123 • Click Save.

Task	Description	UI Steps
		<p>Configure the second map.</p> <ol style="list-style-type: none"> a. Click New. b. Configure the map: <ul style="list-style-type: none"> • Alias: GTP-User • Type: First Level, Sub Type: By Rule • Source: 8/1/x40, 8/1/x6 • Destination: vport1 c. Click Add a Rule. <p>Select Pass and Bi Directional Select Port Destination for the rule Set port value to 2152</p> <ol style="list-style-type: none"> d. Click Save. <p>Configure the second map.</p> <ol style="list-style-type: none"> a. Click New. b. Configure the map: <ul style="list-style-type: none"> • Alias: Fragment-Not-First • Type: First Level, Sub Type: By Rule • Source: 8/1/x40, 8/1/x6 • Destination: vport1 c. Click Add a Rule. <ul style="list-style-type: none"> • Select Pass • Select Port IPv4 Fragmentation for the rule • Select allFragNoFirst for Value d. Click Save.
7.	Configure one second level map for GTP whitelisting, the first whitelist map. If there is a match to version 1 and if the IMSI is present in the whitelist (MyIMSI), it is forwarded to the specified	<ol style="list-style-type: none"> a. Select Maps > Maps > Maps. b. Click New. c. Configure the map: <ul style="list-style-type: none"> • Alias: GTP-Whitelist_v1

Task	Description	UI Steps
	port.	<ul style="list-style-type: none"> • Type: Second Level, Sub Type: Flow Whitelist • Source: vport1 • Destination: 1/2x23 • Select gtp-whitelist from the GSOP list. <p>d. Click Add a Rule.</p> <ul style="list-style-type: none"> • Select GTP • Set Version to V1 <p>e. Click Save.</p>
8.	Configure another second level map for GTP whitelisting, the second whitelist map. If there is a match to version 2 and if the IMSI is present in the whitelist (MyIMSI), it is forwarded to the specified port.	<p>a. Select Maps > Maps > Maps.</p> <p>b. Click New.</p> <p>c. Configure the map:</p> <ul style="list-style-type: none"> • Alias: GTP-Whitelist_v2 • Type: Second Level, Sub Type: Flow Whitelist • Source: vport1 • Destination: 1/2x24 • Select gtp-whitelist from the GSOP list. <p>d. Click Add a Rule.</p> <ul style="list-style-type: none"> • Select GTP • Set Version to V2 <p>e. Click Save.</p>

Example 3: GTP Flow Sampling

Example 2 is a GTP flow sampling configuration example. Traffic from network ports go to the three first level maps (GTP-Control, GTP-User, and Fragments-Not_First) and then to the virtual port (vport1). The traffic flow is sampled based on the rules in one flow sampling map (GTP-Sample-01). The flow sampling rules specify IMSI, IMEI, and MSISDN numbers, as well as the percentage to sample. Packets are then accepted or rejected. Accepted packets are forwarded to a port. Rejected packets are dropped. Packets that do not match a rule will be passed to subsequent maps.

Task	Description	UI Steps
1.	Configure a GigaSMART group and associate it with a GigaSMART engine port.	<p>a. From the device view, select GigaSMART > GigaSMART Groups > GigaSMART Groups.</p> <p>b. Click New.</p>

Task	Description	UI Steps
		<ul style="list-style-type: none"> c. Type an alias in the Alias field and enter an engine port in the Port List field. d. Click Save.
2.	Create a virtual port.	<ul style="list-style-type: none"> a. From the device view, select GigaSMART > Virtual Ports. b. In the Alias field, type an alias for this virtual port. c. Type an alias in the Alias field and enter an engine port in the Port List field. d. From the GigaSMART Groups drop-down list, select the GigaSMART group created in task 1. e. Click Save.
3.	Configure three first level maps. <div style="border: 1px solid gray; padding: 5px; margin-top: 10px;"> <p>NOTE: In the rules, 2123 is GTP-c traffic and 2152 is GTP-u traffic.</p> </div>	<ul style="list-style-type: none"> a. Configure the first map as follows: <ul style="list-style-type: none"> • Alias: GTP-Control • Type and subtype: First Level By Rule • Source: network port or ports • Destination: virtual port created in Task 2. • Rule: Pass, Bi Directional, Port Destination 2123 • Map Permissions: Select current user's group for Owner • Save the map b. Configure the second map as follows: <ul style="list-style-type: none"> • Alias: GTP-User • Type and subtype: First Level By Rule • Source: Same network port or ports as first map. • Destination: virtual port created in Task 2. • Rule: Pass, Bi Directional, Port Destination 2152 • Map Permissions: Select current user's group for Owner • Save the map c. Configure the third map as follows: <ul style="list-style-type: none"> • Alias: Fragments-Not-First • Type and subtype: First Level By Rule • Source: Same network port or ports as first map • Destination: virtual port created in Task 2

Task	Description	UI Steps
		<ul style="list-style-type: none"> • Rule: Pass, IPv4 Fragmentation and select allFragNoFirst • Map Permissions: Select current user's group for Owner • Save the map
4.	Configure the GigaSMART operation for GTP flow sampling.	<ol style="list-style-type: none"> a. From the device view, select GigaSMART > GigaSMART Operations (GSOP) > GigaSMART Operations. b. Click New. c. Type an alias in the Alias field. For example, GTP-Whitelist. d. Select the GigaSMART group created in task 1. e. From the GigaSMART Operations (GSOP) drop-down list, select the following: <ul style="list-style-type: none"> • GTP Whitelist and select Enabled. • Load Balancing. f. For Load Balancing, do the following: <ol style="list-style-type: none"> a. Choose Stateful b. For Type select GTP c. Choose Hashing for the metric and select IMSI d. Click Save.
5.	Configure a second level map for GTP flow sampling, the flow sampling map. The traffic flow is sampled based on the rules in this map.	<ol style="list-style-type: none"> a. Select Maps > Maps > Maps. b. Click New. c. Configure the map. <ul style="list-style-type: none"> • Type GTP-Sample-01 in the Alias field • Select Second Level for Type • Select Flow Sample for Subtype. • Select the virtual port configured in Task 2 for the Source • Select a tool port for the Destination • Select the GigaSMART Operation configured in Task for from the GSOP list d. Use the Add a Rule button to create the following flow sampling rules: <ul style="list-style-type: none"> • Percentage to 50, IMEI 01416800* • Percentage to 80, IMSI 46*

Task	Description	UI Steps
		<ul style="list-style-type: none"> • Percentage to 25, MSISDN 1509* • Percentage to 15, IMSI 01400* • Percentage to 20, IMSI, 31*, MSISDN 1909* e. Click Save.

Example 4: GTP Whitelisting, GTP Flow Sampling, and Load Balancing

Example 4 combines the GTP whitelisting configuration from Example 1 with the GTP flow sampling configuration from Example 3, and adds GigaSMART load balancing.

In Example 4, traffic from network ports go to the three first level maps (GTP-Control, GTP-User, and Fragments-Not-First) and then to the virtual port (vport1). If there is a match to an IMSI in the whitelist (MyIMSI), it is forwarded to the port group (PG-Whitelist) for load balancing.

NOTE: In Example 4, the tool ports in the port group are on the same node as the GigaSMART group and GigaSMART operation.

If there is not a match to an IMSI in the whitelist, the traffic flow is sampled based on the rules in the flow sampling map (GTP-Sample-01). The flow sampling rules specify IMSI, IMEI, and MSISDN numbers, as well as the percentage to sample. Packets are then accepted or rejected. Accepted packets are forwarded to the port group (PG-Sample) for load balancing. Rejected packets are dropped. Packets that do not match a rule will be passed to subsequent maps.

Task	Description	UI Steps
1.	Create port groups and specify the tool ports and enable load balancing.	<ol style="list-style-type: none"> a. Select Ports > Port Groups > All Port Groups. b. Click New. c. Type PG-Whitelist in the Alias field. d. Select SMART Load Balancing e. Click in the Ports field and select the tool ports for the port group. f. Click Save. g. Repeat steps 2 through 6, to create a port group with the alias PF-Sample.
2.	Configure a GigaSMART group and associate it with a GigaSMART engine port.	<ol style="list-style-type: none"> a. From the device view, select GigaSMART > GigaSMART Groups > GigaSMART Groups. b. Click New. c. Type an alias in the Alias field and enter an engine port in the Port List field.

Task	Description	UI Steps
3.	Create a virtual port.	<p>d. Click Save.</p> <p>a. From the device view, select GigaSMART > Virtual Ports.</p> <p>b. In the Alias field, type an alias for this virtual port.</p> <p>c. Type an alias in the Alias field and enter an engine port in the Port List field.</p> <p>d. From the GigaSMART Groups drop-down list, select the GigaSMART group created in task 1.</p> <p>e. Click Save.</p>
4.	Configure three first level maps. <div data-bbox="326 625 675 743" style="border: 1px solid gray; padding: 5px; margin-top: 10px;"> <p>NOTE: In the rules, 2123 is GTP-c traffic and 2152 is GTP-u traffic.</p> </div>	<p>a. Configure the first map as follows:</p> <ul style="list-style-type: none"> • Alias: GTP-Control • Type and subtype: First Level By Rule • Source: network port or ports • Destination: virtual port created in Task 2. • Rule: Pass, Bi Directional, Port Destination 2123 • Map Permissions: Select current user's group for Owner • Save the map <p>b. Configure the second map as follows:</p> <ul style="list-style-type: none"> • Alias: GTP-User • Type and subtype: First Level By Rule • Source: Same network port or ports as first map. • Destination: virtual port created in Task 2. • Rule: Pass, Bi Directional, Port Destination 2152 • Map Permissions: Select current user's group for Owner • Save the map <p>c. Configure the third map as follows:</p> <ul style="list-style-type: none"> • Alias: Fragments-Not-First • Type and subtype: First Level By Rule • Source: Same network port or ports as first map • Destination: virtual port created in Task 2 • Rule: Pass, IPv4 Fragmentation and select

Task	Description	UI Steps
		<p>allFragNoFirst</p> <ul style="list-style-type: none"> • Map Permissions: Select current user's group for Owner • Save the map
5.	Create the GTP whitelist.	<ol style="list-style-type: none"> a. From the device view, select GigaSMART > GTP Whitelist. b. Click New. c. Type an Alias for the Whitelist in the Alias field. For example, MyIMSI
6.	Fetch whitelist files from a specified location to populate the GTP whitelist.	<ol style="list-style-type: none"> a. On the GTP Whitelist page, select Bulk Upload. b. Select Bulk Entry Operation for IMSI Upload Type c. Select Upload from URL from the Bulk Upload Type list. d. Enter the URL in the Enter Remote URL field. For example, http://10.1.1.100/tftpboot/myfiles/MyIMSI_file2.tx e. Click Save.
7.	(Optional) Add a single IMSI to the GTP whitelist.	<ol style="list-style-type: none"> a. On the GTP Whitelist page, select Individual Entry Operation. b. Select Append for Operation Type c. Enter the IMSI entry in the Individual IMSI Entry field. d. Click Save.
8.	Associate the GigaSMART group to the GTP whitelist.	<ol style="list-style-type: none"> a. From the device view, select GigaSMART > GigaSMART Groups > GigaSMART Groups. b. Click New. c. Type an alias in the Alias field. d. Under GTP Whitelist, click on the GTP Whitelist Alias field and select the alias from Task 5. e. Click Save.
9.	Configure the GigaSMART operation for GTP whitelisting.	<ol style="list-style-type: none"> a. From the device view, select GigaSMART > GigaSMART Operations (GSOP) > GigaSMART Operation. b. Click New. c. Select the GigaSMART Group created in Task 8 from the GigaSMART Groups list. d. Type an alias in the Alias field. For example, gtp-whitelist. e. Select GTP Whitelist from the GigaSMART Operations (GSOP) list. f. Select Load Balancing from the GigaSMART Operations (GSOP) list. g. Configure Load Balancing as follows: <ul style="list-style-type: none"> • Select Stateful

Task	Description	UI Steps
		<ul style="list-style-type: none"> • Set Type to GTP • Select Hashing • Select IMSI <p>h. Click Save.</p>
10.	Configure a second level map for GTP whitelisting, the whitelist map. If there is a match to an IMSI in the whitelist (MyIMSI), it is forwarded to a load balancing port group.	<p>a. Select Maps > Maps > Maps.</p> <p>b. Click New</p> <p>c. Configure the map.</p> <ul style="list-style-type: none"> • Type an name in the Alias field. For example GTP-Whitelist. • Select Second Level for Type • Select By Rule for Subtype • Select the GigaSMART Operation configured in Task 9 from the GigaSMART Operations (GSOP) list. • Select the virtual port configured in Task 3 for Source • Select PG-Whitelist for Destination <p>d. Click Save.</p>
11.	Configure the GigaSMART operation for GTP flow sampling.	<p>e. From the device view, select GigaSMART > GigaSMART Operations (GSOP) > GigaSMART Operation.</p> <p>f. Click New.</p> <p>g. Select the GigaSMART Group created in Task 8 from the GigaSMART Groups list.</p> <p>h. Type an alias in the Alias field. For example, gtp-flowsample.</p> <p>i. Select Flow Sampling from the GigaSMART Operations (GSOP) list.</p> <p>j. Select Flow Sampling-GTP.</p> <p>k. Select Load Balancing from the GigaSMART Operations (GSOP) list.</p> <ul style="list-style-type: none"> • Select Stateful • Set Type to GTP • Select Hashing • Select IMSI <p>l. Click Save.</p>
12.	Configure a second level map for	<p>a. Select Maps > Maps > Maps.</p>

Task	Description	UI Steps
	<p>GTP flow sampling, the flow sampling map. If there is not a match to an IMSI in the whitelist, the traffic flow is sampled based on the rules in this map. Accepted packets are forwarded to a load balancing port group.</p>	<ul style="list-style-type: none"> b. Click New c. Configure the map. <ul style="list-style-type: none"> • Type an name in the Alias field. For example GTP-Sample-01. • Select Second Level for Type • Select Flow Sample for Subtype • Select the GigaSMART operation for flow sampling configured in Task 11 from the GSOP list. • Select the virtual port configured in Task 3 for Source • Select PG-Sample for Destination d. Create the following flow sample rules: <ul style="list-style-type: none"> • Percentage 50, IMEI 01416800*, IMSI 31* • Percentage 80, IMSI 46* • Percentage 25, MSISDN 1509* • Percentage 15, IMEI 01400*, imsi 31* • Percentage 20, IMSI 31*, MSISDN 1909* e. Click Save.

Example 5: GTP Flow Sampling with Multiple Maps

Example 5 includes multiple GTP flow sampling maps, which provide a more granular selection of tool ports for flow sampling.

In Example 5, traffic from network ports go to the three first level maps (GTP-Control, GTP-User, and Fragments-Not_First) and then to the virtual port (vport1). If there is a match to an IMSI in the whitelist (VoLTE_1MM), it is forwarded to the port-group (PG-Whitelist-1) for load balancing.

NOTE: In Example 5, the tool ports in the port group are on the same node as the GigaSMART group and GigaSMART operation.

If there is not a match to an IMSI in the whitelist, the traffic flow is sampled based on the rules in the four flow sampling maps (GTP-Sample-1 to GTP-Sample-4).

The flow sampling rules in each map specify IMSI, IMEI, and MSISDN numbers, as well as the percentage to sample. Packets are then accepted or rejected. Accepted packets are forwarded to the port-group (PG-Sample-1 to PG-Sample-4) for load balancing. Rejected packets are dropped. Packets that do not match a rule will be passed to subsequent maps, in this example, to a shared collector.

Task	Description	UI Steps
1.	Create port groups, specifying the tool ports and enabling load balancing.	<ol style="list-style-type: none"> a. Select Ports > Port Groups > All Port Groups. b. Click New. c. Type PG-Sample-1 in the Alias field. d. Select SMART Load Balancing e. Click in the Ports field and select the tool ports for the port group. f. Click Save. g. Repeat steps 2 through 6, to create a port groups with the aliases
2.	Configure a GigaSMART group and associate it with a GigaSMART engine port.	<ol style="list-style-type: none"> a. From the device view, select GigaSMART > GigaSMART Groups > GigaSMART Groups. b. Click New. c. Type an alias in the Alias field and enter an engine port in the Port List field. d. Click Save.
3.	Create a virtual port.	<ol style="list-style-type: none"> a. From the device view, select GigaSMART > Virtual Ports. b. Type vport1 in the Alias field. c. Select the GigaSMART Groups created in Task 2 from the GigaSMART Group list. d. Click Save.
4.	Configure three first level maps. <div style="border: 1px solid black; padding: 5px; margin-top: 10px;"> <p>NOTE: In the rules, 2123 is GTP-c traffic and 2152 is GTP-u traffic.</p> </div>	<ol style="list-style-type: none"> a. Configure the first map as follows: <ul style="list-style-type: none"> • Alias: GTP-Control • Type and subtype: First Level By Rule • Source: network ports (for example, 10/1/x5, 10/3/x1,10/6/q1) • Destination: virtual port created in Task 2. • Rule: Pass, Bi Directional, Port Destination 2123 • Save the map b. Configure the second map as follows: <ul style="list-style-type: none"> • Alias: GTP-User • Type and subtype: First Level By Rule

Task	Description	UI Steps
		<ul style="list-style-type: none"> • Source: Same network ports as first map. • Destination: virtual port created in Task 2. • Rule: Pass, Bi Directional, Port Destination 2152 • Save the map c. Configure the third map as follows: <ul style="list-style-type: none"> • Alias: Fragments-Not-First • Type and subtype: First Level By Rule • Source: Same network ports as first map • Destination: virtual port created in Task 2 • Rule: Pass, IPv4 Fragmentation and select allFragNoFirst • Save the map
5.	Create the GTP whitelist.	<ol style="list-style-type: none"> a. From the device view, select GigaSMART > GTP Whitelist. b. Click New. c. Enter VoLTE_1MM in the Alias field. d. Go to Task 6.
6.	Fetch whitelist files from a specified location to populate the GTP whitelist.	<ol style="list-style-type: none"> a. On the GTP Whitelist page, select Bulk Upload. b. Select Bulk Entry Operation for IMSI Upload Type c. Select Upload from URL from the Bulk Upload Type list. d. Enter the URL in the Enter Remote URL field. For example, http://10.1.1.100/tftpboot/myfiles/MyIMSI_file2.tx e. Click Save.
7.	(Optional) Add a single IMSI to the GTP whitelist.	<ol style="list-style-type: none"> a. On the GTP Whitelist page, select Individual Entry Operation. b. Select Append for Operation Type c. Enter the IMSI entry in the Individual IMSI Entry field. d. Click Save.
8.	Associate the GigaSMART group to the GTP whitelist.	<ol style="list-style-type: none"> a. From the device view, select GigaSMART > GigaSMART Groups > GigaSMART Groups b. Click New. c. Type gsg1 in the Alias field. d. Under GTP Whitelist, click on the GTP Whitelist Alias field and select VoLTE_1MM. e. Click Save.
9.	Configure the GigaSMART	<ol style="list-style-type: none"> a. From the device view, select GigaSMART > GigaSMART

Task	Description	UI Steps
	operation for GTP whitelisting.	<p>Operations (GSOP) > GigaSMART Operation.</p> <ol style="list-style-type: none"> b. Click New. c. Select the GigaSMART Group gsg1 created in Task 8 from the GigaSMART Groups list. d. Enter gtp-whitelistl in the Alias field. e. Select GTP Whitelist from the GigaSMART Operations (GSOP) list f. Select Load Balancing from the GigaSMART Operations (GSOP) list. g. Configure Load Balancing as follows: <ul style="list-style-type: none"> • Select Stateful • Set Type to GTP • Select Hashing • Select IMSI h. Click Save.
10.	Configure a second level map for GTP whitelisting, the whitelist map. If there is a match to an IMSI in the whitelist (VoLTE_1MM), it is forwarded to a load balancing port group.	<ol style="list-style-type: none"> a. Select Maps > Maps > Maps. b. Click New c. Configure the map. <ul style="list-style-type: none"> • Enter GTP-Whitelist in the Alias field. • Select Second Level for Type • Select By Rule for Subtype • Select gtp-whitelist from the GSOP list. • Select the virtual port vport1 configured in Task 3 for Source • Select port group PG-Whitelist-2 for Destination d. Click Save.
11.	Configure the GigaSMART operation for GTP flow sampling.	<ol style="list-style-type: none"> a. From the device view, select GigaSMART > GigaSMART Operations (GSOP) > GigaSMART Operation. b. Click New. c. Select the GigaSMART Group created in Task 8 from the GigaSMART Groups list. d. Enter gtp-flowsample-1 in the Alias field. e. Select Flow Sampling from the GigaSMART Operations (GSOP) list and then select the Flow Sampling-GTP option. f. Select Load Balancing from the GigaSMART Operations (GSOP) list.

Task	Description	UI Steps
		<p>g. Configure Load Balancing as follows:</p> <ul style="list-style-type: none"> • Select Stateful • Set Type to GTP • Select Hashing • Select IMSI <p>h. Click Save.</p>
12.	<p>Configure a second level map for GTP flow sampling, the first flow sampling map. This map has 12 rules.</p> <p>Traffic flow is sampled based on the rules in this map. Accepted packets are forwarded to a load balancing port group.</p>	<p>a. Select Maps > Maps > Maps.</p> <p>b. Click New.</p> <p>c. Configure the map.</p> <ul style="list-style-type: none"> • Type GTP-Sample-1 in the Alias field • Select Second Level for Type • Select Flow Sample for Subtype. • Select the virtual port vport1 configured in Task 3 for the Source • Select a port group PG-Sampl-1 for the Destination • Select the GigaSMART Operation configured in Task for from the GSOP list <p>d. Use the Add a Rule button to create the following flow sampling rules:</p> <ul style="list-style-type: none"> • Percentage 75, IMSI 3182609833*, IMEI 35609506* • Percentage 10, IMSI 3182609834*, IMEI 3560950* • Percentage 20, IMSI 31826098350*, IMEI 356095* • Percentage 20, IMSI 31826098351*, IMEI 35609* • Percentage 20, IMSI 31826098352*, IMEI 3560* • Percentage 20, IMSI 31826098353*, IMEI 356* • Percentage 20, IMSI 31826098354*, IMEI 35* • Percentage 20, IMSI 31826098355*, IMEI 31* • Percentage 20, IMSI 31826098356*, IMEI 356095* • Percentage 20, IMSI 31826098356*, IMEI 356095*

Task	Description	UI Steps
		<ul style="list-style-type: none"> • Percentage 20, IMSI 31826098357*, IMEI 3560* • Percentage 20, IMSI 31826098358*, IMEI 35* • Percentage 20, IMSI 31826098359*, IMEI 356095* <p>e. Click Save.</p>
13.	<p>Configure a second level map for GTP flow sampling, the second flow sampling map. This map has 12 rules.</p> <p>Traffic flow is sampled based on the rules in this map. Accepted packets are forwarded to a load balancing port group.</p>	<p>a. Select Maps > Maps > Maps.</p> <p>b. Click New.</p> <p>c. Configure the map.</p> <ul style="list-style-type: none"> • Type GTP-Sample-2 in the Alias field • Select Second Level for Type • Select Flow Sample for Subtype. • Select the virtual port vport1 configured in Task 2 for the Source • Select a tool port group PG-Sample-2 for the Destination • Select flow-sample-1 configured in Task 11 for from the GSOP list <p>d. Use the Add a Rule button to create the following flow sampling rules:</p> <ul style="list-style-type: none"> • Percentage 30, IMSI 3182609836*, IMEI 35609506* • Percentage 5, IMSI 3182609837*, IMEI 356095062* • Percentage 50, IMSI 31826098380*, IMEI 356095062* • Percentage 50, IMSI 31826098381*, IMEI 35609506* • Percentage 50, IMSI 31826098382*, IMEI 3560950* • Percentage 50, IMSI 31826098383*, IMEI 356095* • Percentage 50, IMSI 31826098384*, IMEI 35* • Percentage 50, IMSI 31826098385*, IMEI 356* • Percentage 50, IMSI 31826098386*, IMEI 3560* • Percentage 50, IMSI 31826098387*, IMEI 35609* • Percentage 50, IMSI 31826098388*, IMEI 356095*

Task	Description	UI Steps
		<ul style="list-style-type: none"> • Percentage 50, IMSI 31826098389*, IMEI 3560950* <p>e. Click Save.</p>
14.	<p>Configure a second level map for GTP flow sampling, the third flow sampling map. This map has 5 rules.</p> <p>Traffic flow is sampled based on the rules in this map. Accepted packets are forwarded to a load balancing port group.</p>	<p>a. Select Maps > Maps > Maps.</p> <p>b. Click New.</p> <p>c. Configure the map.</p> <ul style="list-style-type: none"> • Type GTP-Sample-3 in the Alias field • Select Second Level for Type • Select Flow Sample for Subtype • Select the virtual port vport1 configured in Task 3 for the Source • Select a port group PG-Sample-3 port for the Destination • Select flow-sample-1 configured in Task 11 for from the GSOP list <p>d. Use the Add a Rule button to create the following flow sampling rules:</p> <ul style="list-style-type: none"> • Percentage 10, IMSI 31826098390*, IMEI 35609506* • Percentage 10, IMSI 31826098391*, IMEI 35609506* • Percentage 10, IMSI 31826098392*, IMEI 35609506* • Percentage 10, IMSI 31826098393*, IMEI 35609506* • Percentage 10, IMSI 31826098394*, IMEI 35609506* <p>e. Click Save.</p>
15.	<p>Configure a second level map for GTP flow sampling, the fourth flow sampling map. This map has one rule.</p> <p>Traffic flow is sampled based on the rules in this map. Accepted packets are forwarded to a load balancing port group.</p>	<p>a. Select Maps > Maps > Maps.</p> <p>b. Click New.</p> <p>c. Configure the map.</p> <ul style="list-style-type: none"> • Type GTP-Sample-4 in the Alias field • Select Second Level for Type • Select Flow Sample for Subtype

Task	Description	UI Steps
		<ul style="list-style-type: none"> • Select the virtual port vport1 configured in Task 3 for the Source • Select a tool port for the Destination • Select flow-sample-1 configured in Task 11 for from the GSOP list d. Use the Add a Rule button to create the following flow sampling rule: <ul style="list-style-type: none"> • Percentage 10, IMSI 31826098429*, IMEI 35609506* e. Click Save.
16.	Configure a collector map for any packets that do not match other rules.	<ul style="list-style-type: none"> a. Select Maps > Maps > Maps. b. Click New. c. Configure the map. <ul style="list-style-type: none"> • Type GTP-Collector in the Alias field • Select Second Level for Type • Select Collector for Subtype • Select the virtual port vport1 configured in Task 3 for the Source d. Click Save.

Display GTP Flow Ops Report Statistics

To display GTP statistics, select **GigaSMART > GigaSMART Operations (GSOP) > Statistics**.

Refer to [Flow Ops Report Statistics Definitions for GTP on page 635](#) for descriptions of these statistics.

Example 6: APN for GTP Whitelisting, GTP Flow Sampling

Example 7 specifies APN patterns for GTP whitelisting and GTP flow sampling.

In Example 7, traffic from network ports go to the two first level maps (gtp_to_v1_c and gtp_to_v1_u) and then to the virtual port (v1).

In the whitelist map, if there is a match to the APN pattern and if the IMSI is present in the whitelist (IMSI), packets are forwarded to a tool port.

If there is not a match to an IMSI in the whitelist, the traffic is flow sampled based on the APN pattern in the flow sampling map. Accepted packets are forwarded to the same tool port as specified in the whitelist map.

Any unmatched traffic goes to a shared collector that sends it to a different tool port.

Task	Description	UI Steps
1.	Configure a network port and two tool ports and enable them.	<ol style="list-style-type: none"> a. Select Ports > Ports > All Ports. b. Click Quick Port Editor. c. Configure a network port. Port 22/3/x3 in this example. d. Configure two tool ports. Port 22/4/x18 and 22/4/x19 in this example. e. Admin enable the ports by selecting Enable for each port. f. Click OK.
2.	Configure a GigaSMART group and associate it with two GigaSMART engine port.	<ol style="list-style-type: none"> a. From the device view, select GigaSMART > GigaSMART Groups > GigaSMART Groups. b. Click New. c. Type an gsg2 in the Alias field. d. In the Port List field, select the engine ports, which are 22/2/e1 and 22/2/e2 in this example e. Click Save.
3.	Create a virtual port.	<ol style="list-style-type: none"> a. From the device view, select GigaSMART > Virtual Ports. b. Type v1 in the Alias field. c. Select the GigaSMART Group created in Task 2 from the GigaSMART Group list. d. Click Save.
4.	Configure two first level maps, one for control traffic and one for user traffic.	<ol style="list-style-type: none"> a. Configure the first map as follows: <ul style="list-style-type: none"> • Alias: gtp_to_v1_c • Type and subtype: First Level By Rule • Source: 22/3/x3 • Destination: virtual port created in Task 2. • Rule 1: Pass, Bi Directional, Port Destination 2123 • Rule 2: Pass, Bi Directional, Port Destination 2122 • Save the map b. Configure the second map as follows: <ul style="list-style-type: none"> • Alias: gtp_to_v1_u • Type and subtype: First Level By Rule

Task	Description	UI Steps
		<ul style="list-style-type: none"> • Source: 22/3/x3. • Destination: virtual port created in Task 2. • Rule 1: Pass, Bi Directional, Port Destination 2152 • Rule 1: Pass, Bi Directional, IPv4 Fragmentation, Value: allFragNoFirst. • Save the map
5.	Create the GTP whitelist.	<ol style="list-style-type: none"> a. From the device view, select GigaSMART > GTP Whitelist. b. Click New. c. Enter gtp-whitelist in the Alias field d. Go to Task 6.
6.	Fetch whitelist files from a specified location to populate the GTP whitelist.	<ol style="list-style-type: none"> a. On the GTP Whitelist page, select Bulk Upload. b. Select Bulk Entry Operation for IMSI Upload Type c. Select Upload from URL from the Bulk Upload Type list. d. Select Append. e. Enter the URL in the Enter Remote URL field. For example, http://10.1.1.100/tftpboot/myfiles/MyIMSI_file2.tx f. Click Save.
7.	(Optional) Add a single IMSI to the GTP whitelist.	<ol style="list-style-type: none"> a. On the GTP Whitelist page, select Individual Entry Operation. b. Select Append for Operation Type c. Enter the IMSI entry in the Individual IMSI Entry field. d. Click Save.
8.	Associate the GigaSMART group to the GTP whitelist.	<ol style="list-style-type: none"> a. From the device view, select GigaSMART > GigaSMART Groups > GigaSMART Groups b. Select GS Group gsg2 created in Task 2 and click Edit c. Under GTP Whitelist, click on the GTP Whitelist Alias field and select gtp-whitelist d. Click Save.
9.	Configure the GigaSMART operation for GTP whitelisting.	<ol style="list-style-type: none"> a. From the device view, select GigaSMART > GigaSMART Operations (GSOP) > GigaSMART Operation. b. Click New. c. Select the GigaSMART Group gsg2 created in Task 2 and associated with the GTP whitelist in Step 8. d. Enter gtp-correlat_gsp_wl in the Alias field. e. Select GTP Whitelist from the GigaSMART Operations (GSOP) list f. Select Load Balancing from the GigaSMART Operations (GSOP) list.

Task	Description	UI Steps
		<p>g. Configure Load Balancing as follows:</p> <ul style="list-style-type: none"> • Select Stateful • Set Type to GTP • Select Hashing • Select IMSI <p>h. Click Save.</p>
10.	Configure a second level map for GTP whitelisting, the whitelist map. If there is a match to the APN pattern and if IMSI is present in the whitelist (IMSI), it is forwarded to a tool port.	<p>a. Select Maps > Maps > Maps.</p> <p>b. Click New</p> <p>c. Configure the map.</p> <ul style="list-style-type: none"> • Enter GTP-Whitelist in the Alias field. • Select Second Level for Type • Select Flow Whitelist for Subtype • Select gtp-correlate_gsg_wl from the GSOP list. • Select the virtual port v1 configured in Task 3 for Source • Select 22/4/x18 for Destination • Rule 1: GTP, APN: mobile.com <p>d. Click Save.</p>
11.	Configure the GigaSMART operation for GTP flow sampling.	<p>a. From the device view, select GigaSMART > GigaSMART Operations (GSOP) > GigaSMART Operation.</p> <p>b. Click New.</p> <p>c. Select the GigaSMART Group gsg2 created in Task 2 and associated with the GTP whitelist in Step 8.</p> <p>d. Enter gtp-correlat_gsp_fs in the Alias field.</p> <p>e. Select GTP Whitelist from the GigaSMART Operations (GSOP) list</p> <p>f. Select Load Balancing from the GigaSMART Operations (GSOP) list.</p> <p>g. Configure Load Balancing as follows:</p> <ul style="list-style-type: none"> • Select Stateful • Set Type to GTP • Select Hashing • Select IMSI <p>h. Click Save</p>

Task	Description	UI Steps
12.	Configure a second level map for GTP flow sampling, the flow sampling map. If there is not a match to an IMSI in the whitelist, the traffic flow is sampled based on the APN pattern in this map. Accepted packets are forwarded to the same tool port as specified in the whitelist map	<ol style="list-style-type: none"> a. Select Maps > Maps > Maps. b. Click New. c. Configure the map. <ul style="list-style-type: none"> • Type from_vp_fs1 in the Alias field • Select Second Level for Type • Select Flow Sample for Subtype. • Select the virtual port v1 configured in Task 3 for the Source • Select a 22/4/x18 for the Destination • Select the GigaSMART Operation gtp-correlate_gsg_fs • Rule 1: GTP, Percentage: 100, APN: imsi* d. Click Save.
13.	Add a shared collector for any unmatched traffic from the virtual port and send it to a different tool port.	<ol style="list-style-type: none"> a. Select Maps > Maps > Maps. b. Click New. c. Configure the map. <ul style="list-style-type: none"> • Type from_vp_scoll in the Alias field • Select Second Level for Type • Select Collector for Subtype • Select the virtual port v1 configured in Task 3 for the Source d. Click Save.

Example 7: APN for FTP Whitelisting, APN and QCI for GTP Flow Sampling

Example 6 specified APN patterns for GTP whitelisting and GTP flow sampling. It also specifies QCI for GTP flow sampling.

In Example 7, traffic from network ports go to the two first level maps (gtp_to_v1_c and gtp_to_v1_u) and then to the virtual port (v1).

In the whitelist map, if there is a match to the APN pattern and if the IMSI is present in the whitelist (IMSI), packets are forwarded to a tool port.

If there is not a match to an IMSI in the whitelist, the traffic is flow sampled based on the APN pattern and QCI value in the flow sampling map. Accepted packets are forwarded to the same tool port as specified in the whitelist map. Only 50% of traffic with QCI 5 is sent to the tool port.

Any unmatched traffic goes to a shared collector that sends it to a different tool port.

Task	Description	UI Steps
1.	Configure a network port and two tool ports and enable them.	<ol style="list-style-type: none"> a. Select Ports > Ports > All Ports. b. Click Quick Port Editor. c. Select a port (for example, 22/2/x3) and set Type to Network. d. Select a port (for example, 22/2/x18) and set Type to Tool e. Select a second port (for example, 22/2/x19) and set Type to Tool. f. Select Enable for Admin on the network and two tool ports. g. Click OK.
2.	Configure a GigaSMART group and associate it with two GigaSMART engine ports	<ol style="list-style-type: none"> a. From the device view, select GigaSMART > GigaSMART Groups > GigaSMART Groups. b. Click New. c. Type gsg2 in the Alias field. d. Click in the Port List field and select two engine ports. For example, 22/2/e1 and 22/2/e2 e. Click Save.
3.	Create a virtual port.	<ol style="list-style-type: none"> a. From the device view, select GigaSMART > Virtual Ports. b. Type v1 in the Alias field. c. Click in the GigaSMART Group field and select the GigaSMART Group created in Task 2. d. Click Save.
4.	Configure two first level maps, one for control traffic and one for user traffic	<ol style="list-style-type: none"> a. Configure the first map as follows: <ul style="list-style-type: none"> • Alias: gtp_to_v1_c • Type and Subtype: First Level By Rule • Traffic Type: select Control • Source: 22/2/3/x3 (network port created in Task 1) • Destination: v1 (virtual port created in Task 3) • Rule 1: Pass, Bi Directional, Port Destination 2123 • Rule 2: Pass, Bi Directional, Port Destination 2122 • Save the map

Task	Description	UI Steps
		<ul style="list-style-type: none"> b. Configure the second map as follows: <ul style="list-style-type: none"> • Alias: gtp_to_v1_u • Type and subtype: First Level By Rule • Source: 22/2/3/x3 (network port created in Task 1) • Destination: v1 (virtual port created in Task 3) • Rule 1: Pass, Bi Directional, Port Destination 2152 • Rule 2: Pass, Bi Directional, IPv4Fragmentation allFragNoFirst • Save the map
5.	Associate the GigaSMART group to the active GTP Whitelist	<ul style="list-style-type: none"> a. From the device view, select GigaSMART > GigaSMART Groups. b. Select the GigaSMART Group created in Task 1 and click Edit. c. Locate the GTP Whitelist param, and enter the alias of whitelist in the GTP Whitelist Alias field. For example, IMSI. d. Save the GigaSMART Group.
6.	Configure the GigaSMART operation for GTP whitelisting.	<ul style="list-style-type: none"> a. From the device view, select GigaSMART > GigaSMART Operations (GSOP) > GigaSMART Operation. b. Click New. c. Select the GigaSMART Group gsg1 created in Task 2 from the GigaSMART Groups list. d. Enter gtp-correlate_gsp_wl in the Alias field. e. Select GTP Whitelist from the GigaSMART Operations (GSOP) list f. Select Load Balancing from the GigaSMART Operations (GSOP) list. g. Configure Load Balancing as follows: <ul style="list-style-type: none"> • Select Stateful • Set Type to GTP • Select Hashing • Select IMSI h. Click Save.
7.	Configure a second level map for GTP whitelisting, the whitelist map. If there is a match to the APN	<ul style="list-style-type: none"> a. Select Maps > Maps > Maps. b. Click New

Task	Description	UI Steps
	<p>pattern and if the IMSI is present in the whitelist (IMSI), packets are forwarded to a tool port.</p>	<ul style="list-style-type: none"> c. Configure the map. <ul style="list-style-type: none"> • Alias: GTP-whitelist • Type and Subtype: Second Level Flow Whitelist • Source: v1 (virtual port created in Task 3) • Destination: 22/4/x18 • GSOP: gtp-corelate_gsg_wl • Select gtp-whitelist from the GSOP list. • Rule: GTP, APN: mobile.com d. Click Save.
8.	<p>Configure the GigaSMART operation for GTP flow sampling.</p>	<ul style="list-style-type: none"> a. From the device view, select GigaSMART > GigaSMART Operations (GSOP) > GigaSMART Operation. b. Click New. c. Select the GigaSMART Group created in Task 2 from the GigaSMART Groups list. d. Enter gtp-corelate_gsg_fs in the Alias field. e. Select Flow Sampling from the GigaSMART Operations (GSOP) list and then select the Flow Sampling-GTP option. f. Select Load Balancing from the GigaSMART Operations (GSOP) list. g. Configure Load Balancing as follows: <ul style="list-style-type: none"> • Select Stateful • Set Type to GTP • Select Hashing • Select IMEI h. Click Save.
9.	<p>Configure a second level map for GTP flow sampling, the flow sampling map. If there is not a match to an IMSI in the whitelist, the traffic flow is sampled based on the APN pattern in this map. Accepted packets are forwarded to the same tool port as specified in the whitelist map.</p>	<ul style="list-style-type: none"> a. Select Maps > Maps > Maps. b. Click New. c. Configure the map. <ul style="list-style-type: none"> • Alias: from_vp_fs1 • Type and Subtype: Second Level Flow Sample • Source: vp1 • Destination: 22/4/x18 • GSOP: gtp-corelate_gsg_fs

Task	Description	UI Steps
		<ul style="list-style-type: none"> • Rule 1: GTP, APN: *imsi*, QCI: 5, Percentage: 50 • Rule: 2: GTP, IMSI: ims*, Percentage 100 <p>d. Click Save.</p>
10.	Add a shared collector for any unmatched traffic from the virtual port and send it to a different tool port.	<p>a. Select Maps > Maps > Maps.</p> <p>b. Click New.</p> <p>c. Configure the map:</p> <ul style="list-style-type: none"> • Alias: from_vp_scoll • Type and Subtype: Regular Collector • Source: v1 • Destination: 22/4/x19 <p>d. Click Save.</p>

Display Flow Ops Reports

GigaSMART provides support for Flow Ops reporting. The Flow Ops reports displays session table statistics for various feature.

Refer to [GigaSMART Group Statistics Definitions](#) for descriptions of these statistics.

You can generate and view the following Flow Ops reports:

- Flow Filtering Reports
- Flow Sampling Reports
- Flow SIP reports

To display the Flow Ops report perform the following steps:

1. From the device view, select **GigaSMART > GigaSMART Groups > Report**.
2. Under **Report Info**, from the **Type** drop down list, select any one of the following report type:
 - Flow Filtering- To display Flow Filtering reports.
 - Flow Sampling - To display Flow Sampling reports.
 - Flow SIP - To display Flow SIP reports.

NOTE: To know more about the fields that appear for each report type, refer to

Display Flow Ops Reports

3. Select a GigaSMART Group - for example: **grp1**.
4. Click **Generate**. The corresponding Flow Ops Report appears.

Flow Ops Report - Field Reference

Report Type	Field	Description
Flow Filtering	<ul style="list-style-type: none"> • Pattern • Any 	<ul style="list-style-type: none"> • Pattern: Select any of the following options from the Pattern drop-down list and provide the value for the option selected: <ul style="list-style-type: none"> • GTP IMSI - To display the report based on the given GTP IMSI value. • GTP IMEI -To display the report based on the given GTP IMEI value. • GTP MSISDN - To display the report based on the given GTP MSISDN value. • Any-Select Any to search for any of the patters.
Flow Sampling	<ul style="list-style-type: none"> • Device IP Address/Mask • Any 	<ul style="list-style-type: none"> • Device IP Address/Mask - Enter a Device IP address/Mask.

Report Type	Field	Description
		<ul style="list-style-type: none"> • Any- Select Any to search for any available device IP address.
Flow SIP	<ul style="list-style-type: none"> • Caller ID Pattern • Any 	<ul style="list-style-type: none"> • Caller ID Pattern - Enter a Caller ID pattern. • Any- Select Any to search for any available device IP address.

Exporting Flow SIP Session Reports

Starting with software version 5.4 support for exporting flow-ops session reports are available for Flow SIP.

To export Flow SIP session reports:

1. Navigate to **From the device view**, select **GigaSMART > GigaSMART Groups > Report**.
2. Generate a Flow SIP report.
3. Click **Export** to download the Flow SIP report you just generated. A text file of the Flow SIP report is saved to your local directory.

NOTE: The session table displays the first 1000 sessions only.

PROTO	TRANSPORT	METHOD	CALLER: IP	CALLEE: IP	PDU	CALL-ID	WL	FS	LB	port
SIP	UDP	PRACK	16127500192 2600:1014:1117:fa3f:c284:4bd2:b621:680e	6513012997 2001:4888:2:fe40:a0:104:0:265	5	9FSyJTYXrA1gwnv8N_8y0A..@26	N	A	-	-
SIP	UDP	PRACK	13175901000 2001:4888:2:fe40:a0:104:0:271	16127500192:npdi 2600:1014:110b:2b28:99f0:ee92:2124:bf12	2	LU-1507640551275087-1220667	N	A	-	-
SIP	UDP	PRACK	15173459109 2001:4888:2:fe40:a0:104:0:271	16127500192:npdi 2600:1014:110b:2b28:99f0:ee92:2124:bf12	57	ak5q9ic-f81dee*LU-150783467	N	A	-	-
SIP	UDP	INVITE	16513012997 2001:4888:202:3f40:a0:104:0:291	16127500192 2001:4888:202:70ff:a0:113::	2	p65546t1507652897m818029c34	N	A	-	-
RTP	UDP		2600:1008:1114:31a9:71e0:1a36:f936:92ca:	unknown:0	0					
RTCP	UDP		2600:1008:1114:31a9:71e0:1a36:f936:92ca:	unknown:1	0					
SIP	UDP	PRACK	14074884255 2001:4888:2:fe40:a0:104:0:26e	16127500192:npdi 2600:1014:1101:2d8e:e38d:e74:f2e:1f18	2	ak5q9ic-8e0ab9*LU-150756420	N	A	-	-
SIP	UDP	PRACK	16123669520 2001:4888:2:fe40:a0:104:0:26e	16127500192:npdi; phone-context=nodomain. 2600:1014:1101:2d8e:e38d:e74:f2e:1f18	5	ak5q9ic-c59071*LU-150747960	N	A	-	-
SIP	UDP	PRACK	14254661456 2001:4888:2:fe40:a0:104:0:271	16127500192:npdi 2600:1014:110b:2b28:99f0:ee92:2124:bf12	23	ak5q9ic-125f5e*LU-150781540	N	A	-	-
SIP	UDP	PRACK	16513012997 2001:4888:2:fe40:a0:104:0:271	16127500192:npdi 2600:1014:110b:2b28:99f0:ee92:2124:bf12	2	ak5q9ic-6628ad*LU-150758881	N	A	-	-
SIP	UDP	INVITE	16123669520 172.18.135.199	11916127500192; phone-context=nodomain.co 172.27.228.244	58	1227181033272111378745906@1	N	A	-	-
RTP	UDP		unknown:0	172.27.212.212:51368	0					
RTCP	UDP		unknown:1	172.27.212.212:51369	0					
RTP	UDP		unknown:0	2001:4888:39:ff01:308:10d:0:10:54058	0					
RTCP	UDP		unknown:1	2001:4888:39:ff01:308:10d:0:10:54059	0					
RTP	UDP		2001:4888:39:ffff:308:106:0:a:44878	unknown:0	0					
RTCP	UDP		2001:4888:39:ffff:308:106:0:a:44879	unknown:1	0					
RTP	UDP		172.17.13.51:37682	unknown:0	0					
RTCP	UDP		172.17.13.51:37683	unknown:1	0					
SIP	UDP	PRACK	16123669520 2001:4888:2:fe40:a0:104:0:26e	16127500192:npdi; phone-context=nodomain. 2600:1014:1101:2d8e:e38d:e74:f2e:1f18	9	ak5q9ic-43f96d*LU-150757237	N	A	-	-

GTP Overlap Flow Sampling Maps

Starting in software version 4.8, GTP overlap flow sampling maps combines GTP whitelisting and GTP flow sampling maps into a GTP overlap flow sampling map group, which allows for selected traffic to be sent to multiple destinations simultaneously.

In this scenario, once traffic matches a map, it will be sent to the destination for that map. However, the matched traffic will also be evaluated by subsequent maps and, if a match occurs, it will be sent to each of the destinations pointed to by the subsequent maps.

Figure 386: GTP Overlap Flow Sampling Map Groups illustrates regular non-overlap mapping where, once a traffic match is achieved in one map, all other maps are ignored.

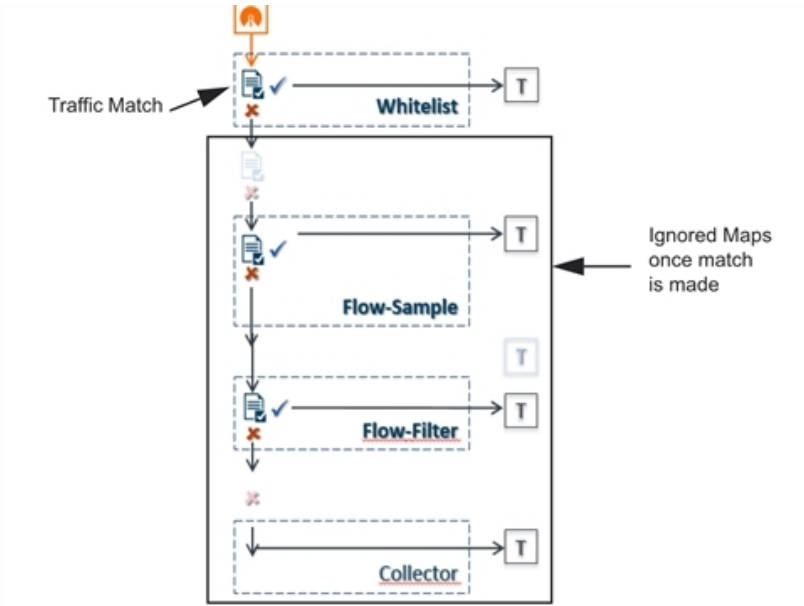


Figure 385: Non-Overlap GTP Mapping Mode

This contrasts with GTP overlap flow sampling maps. In [Figure 385: Non-Overlap GTP Mapping Mode](#) matched traffic is sent to up to six GTP whitelisting and flow sampling map pairs that in turn send accepted traffic to up to six load balanced port groups.

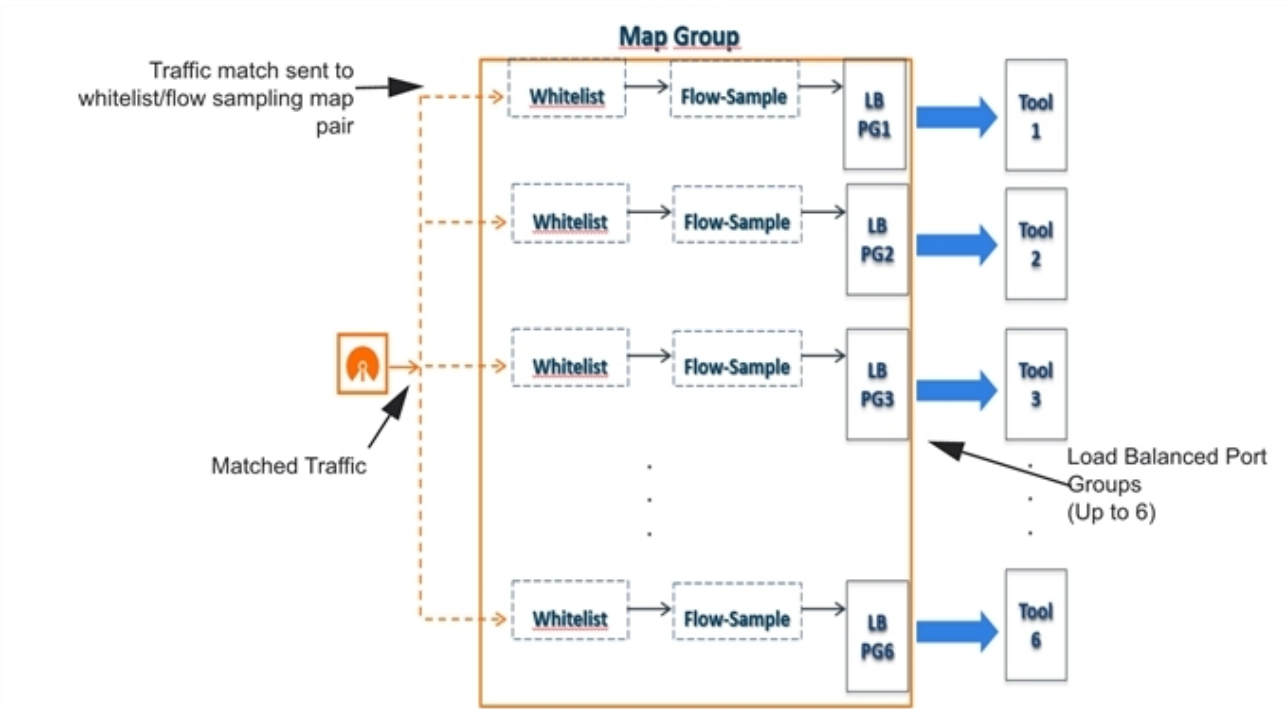


Figure 386: GTP Overlap Flow Sampling Map Groups

Configure GTP Overlap Mapping

The configuration of GTP whitelisting and GTP flow sampling maps that are part of the GTP overlap flow sampling map group follow the same configuration considerations discussed previously in [GigaSMART GTP Whitelisting and GTP Flow Sampling](#). As is the case with regular non-overlap GTP mapping, GTP whitelisting selects specific subscribers based on IMSI, whereas GTP flow sampling uses map rules to select subscribers and then forward a percentage of the packets to tool ports.

Configuration Considerations

This section details certain configuration considerations that apply only to the configuration of GTP whitelisting and flow sampling maps for GTP overlap flow sampling maps.

About GTP Overlap Flow Sampling Map Mode and Port Groups

A second level type map specifying GTP overlap flow sampling map mode must be selected to configure GTP whitelisting and flow sampling maps.

To configure a GTP whilelisting map in overlap flow sampling map mode, select **Type** as **Second Level** and **Subtype** as **Flow Whitlelist Overlap** in a map.

To configure a GTP flow sampling map in GTP overlap flow sampling map mode, select **Type** as **Second Level** and **Subtype** as **Flow Sample Overlap** in a map .

You can configure one GTP whitelisting map and one GTP flow sampling map pair that contain traffic policies corresponding to one destination port group. The load balanced port groups can contain a single port, a port range, or a GigaStream. Note that, starting in software version 4.8, port groups used in GTP overlapping maps support GigaStream.

The maximum number of port groups per single GTP overlap flow sampling map group is six.

For more information about port groups, refer to [Port Groups](#).

Maximum Number of Port Group Members

Use the following sequence to help you determine the maximum number of port group members:

1. Determine the number of members per port group and add 1 to the number.
2. Multiply each port group result times each other.
3. The total multiplication should not exceed 512.

For instance, assume the following configuration in a GTP overlap mapping group:

- Port Group 1—2 load balanced Gigastreams
- Port Group 2—3 load balanced Gigastreams

- Port Group 3—1 load balanced tool port
- Port Group 4—1 load balanced Gigastream
- Port Group 5—4 load balanced tool ports

The total number becomes:

$$(2+1)*(3+1)*(1+1)*(1+1)*(4+1) = 240$$

Since this does not exceed the maximum number of multicast IDs (512), the tool configuration shown is accepted.

GTP Overlap Flow Sampling Map Priority

Since a packet matches multiple maps independently the concept of second level map priority does not apply to GTP overlap flow sampling maps. A GTP overlap flow sampling map pair consists of one GTP whitelisting map and one GTP flow sampling map having the same destination port group. Within a GTP overlap flow sampling map pair the whitelisting map rules will be applied before the flow sampling map rules.

Virtual Port Configuration in GTP Overlap Mode

In GTP Overlap map configuration, the virtual port sending traffic to all the port groups needs to be configured in GTP overlap mode.

To configure the virtual port with GTP overlap mode, select **GTP Overlap** when configuring the virtual port.

About Map Groups

To create a group of maps for GTP whitelisting and GTP flow sampling, select **Maps > Maps > Map Groups**, and then click **New**. The maps for a map group are entered in the **Maps** field. Refer to [GTP Overlap Flow Sampling Maps](#). All the maps in a map group receive traffic according to map rules, rather than map priority. Thus, multiple copies of a GTP packet can be sent to more than one tool.

The **Maps** field of the Map Group page groups the whitelisting and flow sampling maps. For example, assuming that two whitelisting maps (**WLMAP1** and **WLMAP2**) and two flow sampling maps (**FSMAP1** and **FSMAP2**) have been configured in GTP overlap mode, the following example groups them all into the same map group called **map-group1**:

Keep in mind the following configuration considerations for map groups:

- A map group can be associated with only one GigaSMART group (gsgroup).
- All maps within a map group must be connected to the same vport.

- A map group can consist of only one GTP whitelisting map or only one GTP flow sampling map but it cannot contain two maps of the same type.
- Once a map group is created, it cannot be edited to change the type or subtype of the map. However, you can add and edit the map rules for a map while it is configured in a map group.
- If multiple map groups are configured, the maps within each map group must point to the same port groups as the other map groups.

For more information about map groups, refer to [Create Map Groups](#).

About Whitelist Maps

The GTP whitelist is an IMSI list which is common to all whitelist maps. You can configure an optional rule within a whitelist map to specify a GTP version or interface-based policy.

Other than specifying a new second level type using **Type Second Level** and **Subtype Flow Whitelist Overlap** when creating the map, the configuration of GTP whitelist maps follows the same configuration guidelines as given in the section [GTP Whitelisting](#).

A maximum of six whitelist maps sending traffic to six different port groups can be configured per GigaSMART group (gsgroup).

About Flow Sampling Maps

In GTP overlap flow sampling map mode, GTP flow sampling (rule-based flow sampling) is performed after GTP whitelist-based forwarding. Therefore, flow sampling maps have a lower priority than whitelist maps. Thus, within a GTP overlap map pair that consists of a single GTP whitelist overlap map and a GTP flow sampling overlap map, the GTP whitelist map is of higher priority.

Within the flow sampling maps, the rules in the first map have a higher priority than the rules in the second, third, and subsequent maps. Within any single map, rules are evaluated in order.

A maximum of six flow sampling maps sending traffic to six different port groups can be configured per GigaSMART group (gsgroup).

Example 1: GTP Overlap Mode

Example 1 is a GTP overlap mapping mode example.

In Example 1, traffic from a single network port goes to a single first level map (mapLevel1-GTP) which directs GTP-Control, and GTP-User traffic to a virtual port (VP31). Traffic from VP31 is replicated to two GTP whitelisting maps (WLMAP1 and WLMAP2) and two GTP flow sampling maps (FSMAP1 and FSMAP2), which then forward accepted traffic to the final port-group destinations, pg1 and pg2, for load balancing (refer to [Figure 387: GTP Overlap Mode Example 1](#)).

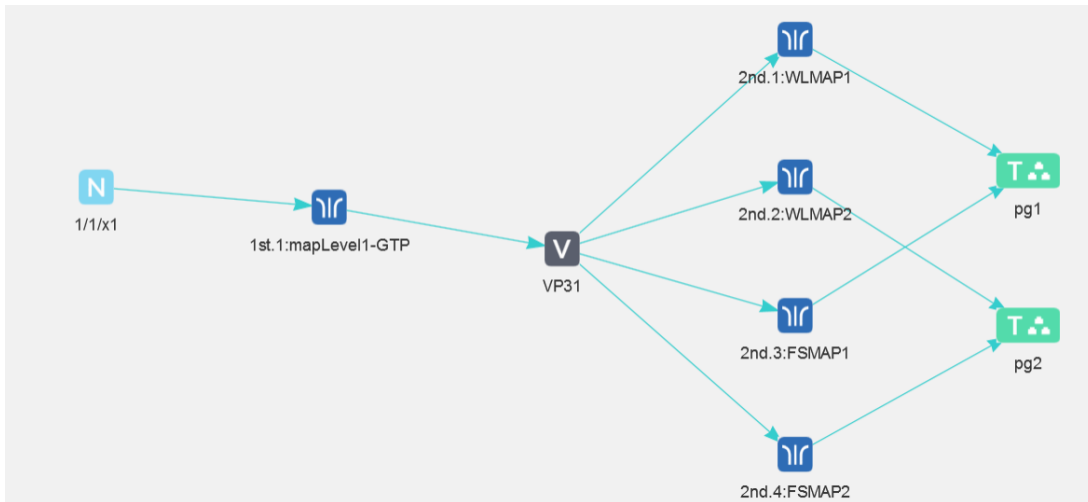


Figure 387: GTP Overlap Mode Example 1

NOTE: In Example 1, the tool ports and GigaStreams in the port group are on the same node as the GigaSMART group and GigaSMART operation.

Within each GTP whitelisting and flow sampling pair, if there is not a match to an IMSI in the whitelist map, the traffic flow is sampled based on the rules in the flow sampling map. The flow sampling rules specify IMSI, IMEI, and MSISDN numbers, as well as the percentage to sample.

Within each map pair, packets are then accepted or rejected. Accepted packets are forwarded to the port groups for load balancing. Rejected packets are dropped.

Use the following steps to configure example 1.

Task	Description	UI Steps
1	Create GigaStreams that will be part of the port groups	<ol style="list-style-type: none"> Select Ports > Port Groups > GigaStreams Click New. Enter gs1 in the Alias field. In the Ports field, select port 1/1x16 and 1/1/x17. Click Save. Configure a second GigaStream with the alias gs2, select ports 1/1/x1 and 1/1/x2 in the Ports field, and click Save.
2	Create port groups and specify the tool ports and assign GigaStreams to the port	<ol style="list-style-type: none"> Select Ports > Port Groups > All Port Groups. Click New. Enter pg1 in the Alias field.

Task	Description	UI Steps
	groups. The port groups will also be load balanced.	<ul style="list-style-type: none"> d. Select Type GigaSMART Load Balancing. e. In the Ports field, select ports 1/1/x6 and 1/1/x7. f. In the GigaStream field, select gs1 g. Click Save. h. Configure a second Port Group. with the alias pg2, select ports1/1/x18 and 1/1/x10 in the Ports field, select GigaSMART Load Balancing, select pg2 in the GigaStream field, and then click Save.
3	Configure a GigaSMART group and associate it with a GigaSMART engine port.	<ul style="list-style-type: none"> a. From the device view, select GigaSMART > GigaSMART Groups. b. Click New. c. Enter GS31 in the Alias field. d. In the Port List field, select an engine port. For example 1/3/e1. e. Click Save.
4.	Create a virtual port. <div style="border: 1px solid black; padding: 5px; margin-top: 10px;"> <p>NOTE: You must enable GTP Overlap when configuring a virtual port for GTP overlap mapping.</p> </div>	<ul style="list-style-type: none"> a. From the device view, select GigaSMART > Virtual Ports > Virtual Ports. b. Click New c. Enter VP31 in the Alias field. d. In the GigaSMART Group field, select GS31. e. Select GTP Overlap, f. Click Save.
5.	Create the GTP Whitelist	<ul style="list-style-type: none"> a. From the device view, select GigaSMART > GTP Whitelist. b. Click New. c. Enter Whitelist in the Alias field d. Go to Task 6.
6.	Fetch whitelist files from a specified location to populate the GTP whitelist.	<ul style="list-style-type: none"> a. On the GTP Whitelist page, select Bulk Upload. b. Select Bulk Entry Operation for IMSI Upload Type c. Select Upload from URL from the Bulk Upload Type list. d. Enter the URL in the Enter Remote URL field. For example, http://10.1.1.100/tftpboot/myfiles/MyIMSI_file2.tx

Task	Description	UI Steps
		<ol style="list-style-type: none"> e. Click Save.
7.	Associate the GigaSMART group to the GTP whitelist.	<ol style="list-style-type: none"> a. From the device view, select GigaSMART > GigaSMART Groups > GigaSMART Groups b. Select GS Group GS31 created in Task 3 and click Edit c. Under GTP Whitelist, click on the GTP Whitelist Alias field and select Whitelist. d. Click Save.
8.	Configure the GigaSMART operation for GTP whitelisting.	<ol style="list-style-type: none"> a. From the device view, select GigaSMART > GigaSMART Operations (GSOP) > GigaSMART Operation. b. Click New. c. Enter gtp-overlapwhitelist1 in the Alias field. d. Select the GigaSMART Group GS31 from the GigaSMART Groups list. e. Select GTP Whitelist from the GigaSMART Operations (GSOP) list f. Select Load Balancing from the GigaSMART Operations (GSOP) list. g. Configure Load Balancing as follows: <ul style="list-style-type: none"> • Select Stateful • Set Type to GTP • Select Hashing • Select IMSI h. Click Save.
9.	Configure the GigaSMART operation for GTP flow sampling.	<ol style="list-style-type: none"> a. From the device view, select GigaSMART > GigaSMART Operations (GSOP) > GigaSMART Operation. b. Click New. c. Enter gtp-overlapsampling1 in the Alias field. d. Select the GigaSMART Group GS31 from the GigaSMART Groups list. e. Select Flow Sampling-GTP

Task	Description	UI Steps
		f. Select Load Balancing from the GigaSMART Operations (GSOP) list. g. Configure Load Balancing as follows: <ul style="list-style-type: none"> • Select Stateful • Set Type to GTP • Select Hashing • Select IMSI e. Click Save.
10.	Configure the first level maps. In the rules, 2123 is GTP-c traffic and 2152 is GTP-u traffic.	a. Configure the first map as follows: <ul style="list-style-type: none"> • Alias: mapLevel1-GTP • Type and Subtype: First Level By Rule • Source: 1/1/x1 • Destination: VP31 • Rule 1: Pass, Bi Directional, Port Destination 2123 • Rule 2: Pass, Bi Directional, Port Destination 2152 • Click Save.
11.	Configure the first second level GTP overlap map for GTP whitelisting. If there is a match to an IMSI in the whitelist for GTP version 1 traffic, it is then forwarded to load balancing port group <i>pg1</i> .	a. Select Maps > Maps > Maps. b. Click New c. Configure the map. <ul style="list-style-type: none"> • Alias: WLMAP1 • Type and Subtype: Second Level GTP Flow Whitelist Overlap • Source: VP3 • Destination: pg1 • GSOP: gtp-whitelist • Rule 1: GTP, APN: Version V1 g. Click Save.
12.	Configure a second level map for GTP flow sampling, the flow sampling map. If there is not a match to an IMSI in the whitelist,	a. Select Maps > Maps > Maps. b. Click New c. Configure the map.

Task	Description	UI Steps
	the traffic flow is sampled based on the rules in this map. Accepted packets are forwarded to load balancing port group <i>pg1</i> .	<ul style="list-style-type: none"> • Alias: FSMAP1 • Type and Subtype: Second Level GTP Flow Sample Overlap • Source: VP3 • Destination: pg1 • GSOP: gtp-overlapsample1 • Rule 1: GTP, IMSI: 3102609834*, IMEI: 35609506*, Percentage: 20 <p>g. Click Save.</p>
13.	Configure the next second level GTP overlap map for GTP whitelisting. If there is a match to an IMSI in the whitelist for GTP version 2 traffic, it is then forwarded to load balancing port group <i>pg2</i> .	<p>a. Select Maps > Maps > Maps.</p> <p>b. Click New.</p> <p>c. Configure the map.</p> <ul style="list-style-type: none"> • Alias: WLMAP2 • Type and Subtype: Second Level Flow Whitelist Overlap • Source: VP31 • Destination: pg2 • GSOP: gtp-whitelist • Rule 1: GTP, APN: Version V2 <p>g. Click Save.</p>
14.	Configure the next second level map for GTP flow sampling. If there is not a match to an IMSI in the whitelist as evaluated by the second level GTP whitelisting map <i>WLMAP2</i> , the traffic flow is sampled based on the rules in this map. Accepted packets are forwarded to load balancing port group <i>pg2</i> .	<p>a. Select Maps > Maps > Maps.</p> <p>b. Click New.</p> <p>c. Configure the map:</p> <ul style="list-style-type: none"> • Alias: FSMAP2 • Type and Subtype: Second Level GTP Flow Sample Overlap • Source: VP31 • Destination: pg2 • Rule 1: GTP, IMSI: 3102609835*, IMEI: 35609507*, Percentage: 20 <p>f. Click Save.</p>

Task	Description	UI Steps
15.	Configure a map group. Add the GTP whitelisting and the two GTP flow sampling maps configured in previous steps.	<ol style="list-style-type: none"> Select Maps > Map Groups. Click New. Enter OverlapMap in the Alias field. In the Maps field, select WLMAP1,WLMAP2,FSMAP1,FSMAP2. Click Save.

Overlap Map Statistics

Starting with version 5.4 overlap and non-overlap maps are available. Overlap maps are displayed based on the following:

- If at least 1 flow-sample map accepts the packets among all the pairs of overlap maps, the Sample (Tx) counters in the GTP Interface stats will be incremented. If more than 1 pair of maps accepts the packets, the Sample (Tx) counters in the GTP Interface stats is incremented only once.
- If at least 1 Whitelist map matches the packets among all the pairs of overlap maps, the Sample (Tx) counters in the GTP Interface stats will be incremented. If more than 1 pair of maps matches the packets, the Sample (Tx) counters in the GTP Interface stats is incremented only once.
- If there are no WL maps and all flow sample maps are no rule match, then Sample(Tx) and Sample Out counters in the GTP Interface stats is not incremented.

GTP Scaling

GTP can be scaled as follows:

- [GigaSMART Cards in GigaVUE-HD8](#)
- [GTP Engine Grouping](#)

GigaSMART Cards in GigaVUE-HD8

Required License: GTP Filtering & Correlation

Starting in software version 4.5, a total of six GigaSMART-HD0 line cards are supported on a single GigaVUE-HD8 node. This provides a total of twelve GigaSMART engine ports, which increases the amount of GigaSMART processing available on the GigaVUE-HD8.

The increased number of GigaSMART line cards in the GigaVUE-HD8 can be used by the following GTP applications: GTP flow filtering, GTP flow sampling, and GTP whitelisting.

GTP Engine Grouping

Required License: GTP Filtering & Correlation

A GigaSMART group (gsgroup) associated with GTP applications can have multiple GigaSMART engine port members. Up to four engine ports can be combined to form an engine group. The engine group provides higher capacity to GTP applications by load balancing GTP user-data plane (GTP-u) traffic among the members of the group. Grouping multiple GigaSMART engine ports increases the effective throughput for GTP applications.

NOTE: Software version 5.5 supports a maximum of 6 million GTP subscriber sessions for GigaVUE-HC2 nodes, whereas, it supports 12 million GTP subscriber sessions for GigaVUE-HC3 nodes.

Starting in software version 4.5.01, it is supported on GigaVUE-HC2 nodes. GTP engine grouping can be used by the following GTP applications: GTP flow filtering, GTP flow sampling, and GTP whitelisting.

The following table lists GTP engine grouping support for GigaVUE nodes:

GigaVUE Node	Maximum Number of GigaSMART Line Cards per Node	Number of e ports per Line Card	Supported Number of e ports per GigaSMART Group	Location of e ports
GigaVUE-HC3	4	2	8	e1 and e2 on same module
GigaVUE-HC2	4	1	4	any front modules
GigaVUE-HC1	Not supported in this software version.			

Keep in mind the following recommendations and restrictions:

- Configure a GTP engine group on a single GigaVUE node.
- Configure either two or four engine ports per GigaSMART group in a GTP engine group.

NOTE: One engine port per GigaSMART group is the default behavior supported in software version 4.5 and prior releases without GTP engine grouping.

- On the GigaVUE-HC2, use only GigaSMART front modules in the engine group (not GigaSMART rear modules).

- GTP engine grouping only supports IMSI hash-based load balancing.
- GTP engine grouping is limited to out-of-band cluster configurations in this software version.

Passing GTP Control Traffic

Selecting the **Control** option for **Traffic Type** of the a First Level By Rule map specifies an option for GTP applications to pass GTP control traffic (GTP-c) to all GigaSMART engines in a GTP engine group. GTP-c traffic is sent to all members of the engine group in order to replicate the session tables.

NOTE: In the map with the **Control** selected for **Traffic Type**, only one vport is supported.

Starting in software version 4.7, the map with the **Traffic Type Control** set can be edited. For example, **Traffic Type Control** can be added to an existing first level map, or it can be deleted from a first level map by clearing the **Control** checkbox for **Traffic Type** (refer to [Figure 388: GTP Control Traffic Selected](#)). Other editing, such as changing the **Source** or the **Destination** in the first level map is also allowed.

Starting in software version 4.7, the map with **Traffic Type Control** set can be edited. For example, **Control** can be selected in an existing first level map, or it can be deleted from a first level map by clearing **Control**. Other editing, such as changing the **Source** or the **Destination** in the first level map is also allowed.

To set GTP Control Traffic:

1. From the device view, select **GigaSMART > Maps > Maps** and click **New**.
2. On the New Map page, select **First Level** and **By Rule** for the map type and subtype, respectively.
3. Select **Control** as shown in [Figure 388: GTP Control Traffic Selected](#)
4. Configure the map and click **Save** when done.

The screenshot shows a configuration panel titled 'Map Info'. It contains the following fields and values:

- Map Alias: to_HC3
- Comments: (empty)
- Enable:
- Type: First Level
- Subtype: By Rule
- Traffic Type: Control

Figure 388: GTP Control Traffic Selected

Upgrade from Earlier Release

When there is existing GTP configuration with one engine port per GigaSMART group in a pre-4.5 software version, an upgrade from that earlier software version to 4.5 or a higher release will succeed.

However in the 4.5 or higher release, you cannot convert that configuration to multiple engine ports per GigaSMART group. You must delete the configuration and reconfigure it, including the GigaSMART group, GigaSMART operation, virtual port, and maps. This is due to the need for separate maps for GTP control plane and GTP user plane traffic in 4.5 and higher releases.

Modify Engine Ports in GigaSMART Group

You can modify the engine ports in a GigaSMART group. For example, you can add an engine port to a GigaSMART group or remove an engine port from a GigaSMART group. After the change, reset all the GigaSMART line cards or modules that have engine ports configured in the GigaSMART group.

Modify vports in Map

You can modify the vport relating to the first level map with Traffic Type Control set. For example, you can change the vport configured in the map. After the change, reset all the GigaSMART line cards or modules that have engine ports configured in the vport.

Configure GTP Engine Grouping

Refer to the following examples:

- [GTP Engine Grouping Configuration Example](#)
- [GTP Engine Grouping Configuration Complex Example](#)

GTP Engine Grouping Configuration Example

This is an example of a GTP engine group consisting of two engine ports on a GigaVUE-HD4 node. This example includes a GigaSMART operation for GTP flow filtering.

Task	Description	UI Steps
1	<p>Configure ports as follows:</p> <ul style="list-style-type: none"> one network type of port. This will be used as the Source attribute in two first level maps in Task 5 and Task 6. one tool type of port for the Destination attribute in a second level flow filtering map in Task 7. one tool type of port for the Destination attribute in a shared collector map in Task 8. <p>Then administratively enable the ports.</p>	<ol style="list-style-type: none"> Select Ports > Ports > All Ports Click Quick Port Editor Configure a network port and two tool ports. For example, select Network for port 22/3/x3 and select Tool for ports 22/3/x1 and 22/1/x11. Select Enable for each port. Click OK. Close the Quick Port Editor.
2	<p>Configure a GigaSMART group and associate it with two GigaSMART engine ports, to form the GTP engine group. The GigaSMART group will be used in Task 5 and Task 6.</p>	<ol style="list-style-type: none"> From the device view, select GigaSMART > GigaSMART Groups > GigaSMART Groups. Type gsg2 in the Alias field. Click in the Port List field to add the two engine ports. Click Save.
3	<p>For GTP flow filtering, configure a flow filtering GigaSMART operation and assign it to the GigaSMART group. The gsop will be used in the second level flow filtering map in Task 7.</p>	<ol style="list-style-type: none"> From the device view, select GigaSMART > GigaSMART Operations (GSOP) > GigaSMART Operation. Type gtp_gsg2 in the Alias field. Select gsg2 from the GigaSMART Groups list. Select Flow Filtering from the GigaSMART Operations list. (GSOP). Click Save.
4	<p>Configure a virtual port and assign it to the same GigaSMART group. This virtual port will be used as the Destination in the first level maps in Task 5 and Task 6, as the Source in the second level map in Task 7, and as the Source attribute in the shared collector map in Task 8.</p>	<ol style="list-style-type: none"> From the device view, select GigaSMART > Virtual Ports. Click New. Type vp1 in the Alias field. Select gsg2 from the GigaSMART Groups list. Click Save.
5	<p>Create a first level map that directs GTP control traffic from the physical network port to the virtual port created in Task 4.</p>	<ol style="list-style-type: none"> Select Maps > Maps > Maps. Click New. Configure the map.

Task	Description	UI Steps
	<p>NOTE: In the rule, 2123 is GTP-c traffic.</p> <p>This map, with the Traffic Type Control attribute, identifies the GTP-c control traffic needed for GTP engine grouping.</p> <p>NOTE: The order of configuration is important. Set Traffic Type Control before any map rules.</p>	<ul style="list-style-type: none"> • Type gtp_to_vp1-c in the Alias field • Select First Level for Type • Select By Rule for Subtype • Select Control for Traffic Type • Select 22/3/x3 for Source • Select vp1 for Destination <ol style="list-style-type: none"> 4. Add a rule. <ol style="list-style-type: none"> a. Click Add a Rule. b. Select Pass and Bi Directional c. Select Port Destination and specify 2123 4. Click Save.
6	<p>Create another first level map that directs GTP user traffic from the physical network port to the virtual port created in Task 5.</p> <p>NOTE: In the rule, 2152 is GTP-u traffic.</p> <p>GTP-u traffic corresponding to the same GTP-c traffic will be sent to the same virtual port.</p>	<ol style="list-style-type: none"> 1. Select Maps > Maps > Maps. 2. Click New. 3. Configure the map. <ul style="list-style-type: none"> • Type gtp_to_vp1 in the Alias field • Select First Level for Type • Select By Rule for Subtype • Select Control for Traffic Type • Select the network configured in Task 1 for Source • Select vp1 for Destination 4. Add a rule. <ol style="list-style-type: none"> a. Click Add a Rule. b. Select Pass and Bi Directional c. Select Port Destination and specify 2123 4. Click Save.
7	<p>Create a second level map for GTP flow filtering that takes traffic from the virtual port, applies the flow filtering GigaSMART operation, matches IMEIs and version specified by the flow rule, and sends matching traffic to a tool port.</p>	<ol style="list-style-type: none"> 1. Select Maps > Maps > Maps. 2. Click New. 3. Type from_vp1 in the Alias field. 4. Configure the map. <ul style="list-style-type: none"> • Select Second Level for Type • Select Flow Filter for Subtype

Task	Description	UI Steps
		<ul style="list-style-type: none"> • Select vp1 for Source • Select one of the tool ports configured in Task 1 for Destination. • Select gtp_gsg2 for from the GSOP list. <ol style="list-style-type: none"> 5. Add a Rule. <ol style="list-style-type: none"> a. Click Add a Rule. b. Select Pass. c. Select GTP IMEI. d. Specify * in the IMEI field. e. Select V2 for Version. 6. Click Save.
8	Add a shared collector for any unmatched traffic from the virtual port and send it to a different tool port than in Task 7 .	<ol style="list-style-type: none"> 1. Select Maps > Maps > Maps. 2. Click New. 3. Configure the map. <ul style="list-style-type: none"> • Type from_vp1_scoll in the Alias field. • Select Second Level for Type • Select Collector for Subtype • Select vp1 for Source. • Select the other tool port configured in Task 1 for Destination. 4. Click Save.

GTP Engine Grouping Configuration Complex Example

This is a more complex example of GTP engine grouping than the previous example. This example has four engine ports on two GigaSMART line cards on the same GigaVUE-HD8 node. The GigaSMART line cards are in slots 1 and 3.

The GigaVUE-HD8 node is the cluster master of a two-node out-of-band cluster. A GigaVUE-HD4 is the standby node in the cluster.

This example includes GigaSMART operations for GTP flow filtering with load balancing, GTP flow sampling with load balancing, and GTP whitelisting. The whitelist must be associated with the GigaSMART group on the master node, the GigaVUE-HD8.

Task	Description	UI Steps
1	<p>Configure ports on the GigaVUE-HD8 as follows:</p> <ul style="list-style-type: none"> • One network type of port. This will be used as the Source attribute in two first level maps in Task 11 and Task 12. • Twelve tool type of ports. There are four tool ports in each of three port groups used for load balancing. The port groups will be created in Task 6. • Five tool type of ports for a GigaStream that will be created in Task 2. • Two tool type of ports for another GigaStream that will be created in Task 2. <p>Then administratively enable the ports.</p>	<ol style="list-style-type: none"> 1. On the GigaVUE-HD8, select Ports > Ports > All Ports 2. Click Quick Port Editor. 3. Configure one network port for Task 11 and Task 12. For example, 23/7/6. 4. Configure 12 tool ports for three port groups in Task 6. For example, 23/4/x1..x4 for the first port group, 23/4/x9..x12 for the second tool group, and 23/4/x13..x16 for the third port group. 5. Configure five tool ports for a GigaStream in Task 2. For example, 23/4/x28..x32. 6. Configure two tool ports for another GigaStream in Task 2. For example, 23/7/q1..q2 type tool. 7. Select enable for each port. 8. Click OK. 9. Close the Quick Port Editor.
2	<p>On the GigaVUE-HD8, configure one GigaStream using five tool ports. This will be used as the Destination attribute in the map in Task 11.</p> <p>Configure another GigaStream to be used in the stack link between the GigaVUE-HD8 and GigaVUE-HD4 that will be created in Task 4.</p>	<ol style="list-style-type: none"> 1. Select Ports > Port Groups > GigaStreams 2. Configure a GigaStream with five tool ports. <ol style="list-style-type: none"> a. Click New. b. Type hd8-gs-1 in the Alias field. c. Select Tool GigaStream. d. Click in the Ports field and select the five tool ports configured in Task 1. e. Click Advanced Hash Settings and use the Default setting. f. Click Save. 7. Configure another GigaStream with two tool ports. <ol style="list-style-type: none"> a. Click New. b. Type hd8-80g in the Alias field. c. Select Tool GigaStream. d. Click in the Ports field and select the two tool ports configured in Task 1. e. Click Advanced Hash Settings and use the Default setting.

Task	Description	UI Steps
		<ol style="list-style-type: none"> f. Click Save.
3	<p>Configure ports on the GigaVUE-HD4 as follows:</p> <ul style="list-style-type: none"> • Two tool type of ports for a GigaStream that will be created in Task 4. • One tool type of port that will be used as the Destination in a map in Task 11. • Four tool type of ports for a GigaStream that will be created in Task 4. <p>Then administratively enable the ports.</p>	<ol style="list-style-type: none"> 1. On the GigaVUE-HD4, select Ports > Ports > All Ports 2. Click Quick Port Editor. 3. Configure two tool ports for a GigaStream in Task 4. For example, 33/2/q1..q2 4. Configure one tool ports for the map in Task 11. For example, 33/3/x11. 5. Configure four tool ports for a GigaStream in Task 4. For example, 33/2/x25..x28. 6. Select Enable for each port. 7. Click OK. 8. Close the Quick Port Editor.
4	<p>On the GigaVUE-HD4, configure a GigaStream using two tool ports. This will be used in the stack link created in Task 5. Configure another GigaStream using four tool ports. This will be used in the shared collector in Task 17.</p>	<ol style="list-style-type: none"> 1. Select Ports > Port Groups > GigaStreams 2. Configure a GigaStream with five tool ports. <ol style="list-style-type: none"> a. Click New. b. Type hd4-gs-4 in the Alias field. c. Select Tool GigaStream. d. Click in the Ports field and select the five tool ports configured in Task 1. For example, 33/2/x25..x28. e. Click Advanced Hash Settings and use the Default setting. f. Click Save. 7. Configure another GigaStream with two tool ports. <ol style="list-style-type: none"> a. Click New. b. Type hd8-80g in the Alias field. c. Select Tool GigaStream. d. Click in the Ports field and select the two tool ports configured in Task 1. For example, 33/2/q1..q2. e. Click Advanced Hash Settings and use the Default setting. f. Click Save.
5	<p>Configure the stack link between the GigaVUE-HD4 and GigaVUE-HD8.</p>	<ol style="list-style-type: none"> 1. Select Ports > Port Groups > Stack Links 2. Click New. 3. Select Stack GigaStream. 4. For First Member select hd8-80g. 5. For Second Member select hd4-80g

Task	Description	UI Steps
6	<p>Create three port groups and specify four tool ports each, for load balancing. Also, enable load balancing on each port group.</p> <p>The port groups, hd8-pg-1 and hd8-pg-2, will be used as the Destination in two second level flow sampling maps in Task 14 and Task 15.</p> <p>The port group, hd8-q2x32-1-4, will be used as the Destination in a second level flow filtering map in Task 16</p>	<ol style="list-style-type: none"> 1. Select Ports > Port Groups > All Port Groups. 2. Create the first port group. <ol style="list-style-type: none"> a. Click New. b. Type hd8-pg-1 in the Alias field. c. Select SMART Load Balancing. d. Click in the Ports field and select four tool ports. For example, 23/4/x9..x12. e. Click Save. 6. Create the second port group. <ol style="list-style-type: none"> a. Click New. b. Type hd8-pg-1 in the Alias field. c. Select SMART Load Balancing. d. Click in the Ports field and select four tool ports. For example, 23/4/x13..x16 e. Click Save. 6. Create the second port group. <ol style="list-style-type: none"> a. Click New. b. Type hd8-q2x32-1-4 in the Alias field. c. Select SMART Load Balancing. d. Click in the Ports field and select four tool ports. For example, 23/4/x13..x16 e. Click Save.
7	<p>Configure a GigaSMART group and associate it with four GigaSMART engine ports, two in slot 1 and two in slot 3, to form the GTP engine group.</p> <p>The GigaSMART group will be used in Task 8, Task 9, and Task 10.</p>	<ol style="list-style-type: none"> 1. From the device view, select GigaSMART > GigaSMART Groups > GigaSMART Groups. 2. Click New. 3. Type hd8scale-4engines-slots1and3. 4. Click in the Port List and select the engine ports. For example, 3/1/e1,23/1/e2,23/3/e1,23/3/e2. <p>Go to Task 8.</p>
8	<p>Associate the GigaSMART group to an existing GTP whitelist.</p> <div style="border: 1px solid #ccc; padding: 5px; margin-top: 10px;"> <p>NOTE: The whitelist is only supported on the cluster master node, which is the GigaVUE-HD8 in this example.</p> </div>	<ol style="list-style-type: none"> 1. From the device view, select GigaSMART > GigaSMART Groups > GigaSMART Groups. 2. Under GTP Whitelist, select the alias of an existing whitelist. For example, gtp-whitelist. 3. Click Save.
9	<p>For GTP flow filtering, configure a flow filtering GigaSMART operation, specify load balancing, and assign the GigaSMART operation to the GigaSMART group. The hd8-scale-ff-lb gsop will be</p>	<ol style="list-style-type: none"> 1. Configure a Flow Filtering operation. <ol style="list-style-type: none"> a. From the device view, select GigaSMART > GigaSMART Operations (GSOP) > GigaSMART Operation. b. Click New.

Task	Description	UI Steps
	<p>used in the second level flow filtering map in Task 16.</p> <p>For GTP flow sampling, configure a flow sampling GigaSMART operation, specify load balancing, and assign the GigaSMART operation to the GigaSMART group. The hd8-scale-fs-lb gsop will be used in the two second level flow sampling maps in Task 15 and Task 16.</p> <p>For GTP whitelisting, configure a whitelisting GigaSMART operation, and assign the GigaSMART operation to the GigaSMART group. (This GigaSMART operation is not load balanced.) The hd8-scale-wl gsop will be used in the second level whitelisting map in Task 13.</p>	<ul style="list-style-type: none"> c. Type hd8-scale-ff-lb in the Alias field. d. Select hd8scale-4engines-slots1and3 from the GigaSMART Groups list. e. Select Flow Filtering from the GigaSMART Operations (GSOP) list. f. Click Save. <p>7. Configure a Flow Sampling operation.</p> <ul style="list-style-type: none"> a. From the device view, select GigaSMART > GigaSMART Operations (GSOP) > GigaSMART Operation. b. Click New. c. Type hd8-scale-fs-lb in the Alias field. d. Select hd8scale-4engines-slots1and3 from the GigaSMART Groups list. e. Select Flow Sampling from the GigaSMART Operations (GSOP) list. f. Select Flow Sampling -GTP g. Click Save. <p>8. Configure a Whitelisting operation.</p> <ul style="list-style-type: none"> a. From the device view, select GigaSMART > GigaSMART Operations (GSOP) > GigaSMART Operation. b. Click New. c. Type hd8-scale-wl in the Alias field. d. Select hd8scale-4engines-slots1and3 from the GigaSMART Groups list. e. Select GTP Whitelist from the GigaSMART Operations (GSOP) list. f. Select Enabled (default). g. Click Save.
10	<p>Configure a virtual port and assign it to the same GigaSMART group. This virtual port will be used as the Destination in the first level maps in Task 11 and Task 12, as the Source in the second level maps in Task 13, Task 14, Task 15, Task 16, and as the Source in the shared collector in Task 17.</p>	<ul style="list-style-type: none"> 1. From the device view, select GigaSMART > Virtual Ports 2. Click New. 3. Type vp-hd8scale-4engines-slots1and3 in the Alias field. 4. Select hd8scale-4engines-slots1and3 from the GigaSMART Groups list. 5. Click Save.
11	<p>Create a first level map that directs GTP control traffic from the physical network port to the virtual port created in Task 10.</p> <div style="border: 1px solid gray; padding: 5px; margin-top: 10px;"> <p>NOTE: In the rule, 2123 is GTP-c traffic.</p> </div>	<ul style="list-style-type: none"> 1. Select Maps > Maps > Maps. 2. Configure the map. <ul style="list-style-type: none"> • Type to_hd8_gtpc in the Alias field • Select First Level for Type.

Task	Description	UI Steps
	<p>This map, with the Traffic Type Control enabled, identifies the GTP-c control traffic needed for GTP engine grouping.</p> <p>In addition to the virtual port, traffic is also sent to a GigaStream and a tool port.</p>	<ul style="list-style-type: none"> • Select By Rule for Subtype • Select Control for Traffic Type • Select a network port for the Source. For example, 23/7/q6. • Select the GigaStream port hd8-gs-1, the virtual port p-hd8scale-4engines-slots1and3, and a tool port (for example, 23/7/q6) for the Destination. <ol style="list-style-type: none"> 3. Add a rule. <ol style="list-style-type: none"> a. Click Add a Rule. b. Select Pass and Bi Directional. c. Select Port Destination for the rule. d. Enter 2123 for the port value. 5. Click Save.
<p>12</p>	<p>Create another first level map that directs GTP user traffic from the physical network port to the virtual port created in Task 10.</p> <div style="border: 1px solid gray; padding: 5px; margin: 5px 0;"> <p>NOTE: In the rule, 2152 is GTP-u traffic.</p> </div> <p>GTP-u traffic corresponding to the same GTP-c traffic will be sent to the same virtual port.</p>	<ol style="list-style-type: none"> 1. Select Maps > Maps > Maps. 2. Configure the map. <ul style="list-style-type: none"> • Type to_hd8_gtpu_1 in the Alias field • Select First Level for Type. • Select By Rule for Subtype • Select a network port for the Source. For example, 23/7/q6. • Select the virtual port vp-hd8scale-4engines-slots1and3 for the Destination. 3. Add a rule. <ol style="list-style-type: none"> a. Click Add a Rule. b. Select Pass and Bi Directional. c. Select Port Destination for the rule. d. Enter 2152for the port value. 5. Add a second rule. <ol style="list-style-type: none"> a. Click Add a Rule. b. Select Pass. c. Select IPv4 Fragmentation for the rule. d. Enter 2152for the port value. e. Select allFragNoFirst for Value.

Task	Description	UI Steps
		<ol style="list-style-type: none"> Click Save.
13	<p>Configure a second level map for GTP whitelisting, the whitelist map, that takes traffic from the virtual port, applies the whitelisting GigaSMART operation, and sends traffic to the remote GigaVUE-HD4 node through a GigaStream.</p>	<ol style="list-style-type: none"> Select Maps > Maps > Maps. Configure the map. <ul style="list-style-type: none"> Type from_hd8_wl in the Alias field Select Second Level for Type. Select By Rule for Subtype Select the virtual port vp-hd8scale-4engines-slots1and3 for the Source. Select the GigaStream hd4-gs-1 for the Destination. Select hd8-scale-wl from the GSOP list. Click Save.
14	<p>Configure a second level map for GTP flow sampling. This is the first of two flow sampling maps.</p> <p>This map filters for version 2. It takes traffic from the virtual port and applies the flow sampling GigaSMART operation.</p> <p>Traffic flow is sampled based on the flow sampling rule in this map. Accepted packets are forwarded to load balancing port group hd8-pg-2.</p>	<ol style="list-style-type: none"> Select Maps > Maps > Maps. Configure the map. <ul style="list-style-type: none"> Type from_hd8_fs_v2 in the Alias field Select Second Level for Type. Select Flow Sample for Subtype Select the virtual port vp-hd8scale-4engines-slots1and3 for the Source. Select the port group hd8-pg-2 for the Destination. Select hd8-scale-fs-lb from the GSOP list. Add a rule. <ol style="list-style-type: none"> Click Add a Rule. Select GTP. Enter 60 for Percentage. Enter 5* in the IMSI field. Select V2 for Version Click Save.
15	<p>Configure a second level map for GTP flow sampling. This is the second of two flow sampling maps.</p> <p>This map filters for version 1. It takes</p>	<ol style="list-style-type: none"> Select Maps > Maps > Maps. Configure the map. <ul style="list-style-type: none"> Type from_hd8_fs_v1 in the Alias field

Task	Description	UI Steps
	<p>traffic from the virtual port and applies the flow sampling GigaSMART operation.</p> <p>Traffic flow is sampled based on the flow sampling rule in this map. Accepted packets are forwarded to load balancing port group hd8-pg-1.</p>	<ul style="list-style-type: none"> • Select Second Level for Type. • Select Flow Sample for Subtype • Select the virtual port vp-hd8scale-4engines-slots1and3 for the Source. • Select the port group hd8-pg-1 for the Destination. • Select hd8-scale-fs-lb from the GSOP list. <ol style="list-style-type: none"> 3. Add a rule. <ol style="list-style-type: none"> a. Click Add a Rule. b. Select GTP. c. Enter 60 for Percentage. d. Enter 5* in the IMSI field. e. Select V1 for Version 6. Click Save.
16	<p>Create a second level map for GTP flow filtering that takes traffic from the virtual port, applies the flow filtering GigaSMART operation, matches IMSIs specified by the flow rule, and sends matching traffic to load balancing port group hd8-q2x32-1-4.</p>	<ol style="list-style-type: none"> 1. Select Maps > Maps > Maps. 2. Configure the map. <ul style="list-style-type: none"> • Type from_hd8_ff in the Alias field • Select Second Level for Type. • Select Flow Filter for Subtype • Select the virtual port vp-hd8scale-4engines-slots1and3 for the Source. • Select the port group hd8-pg-1 for the Destination. • Select port group hd8-q2x32-1-4 from the GSOP list. 3. Add a rule. <ol style="list-style-type: none"> a. Click Add a Rule. b. Select GTP IMSI c. Enter * in the IMSI field. d. Select Any for Version 5. Click Save.
17	<p>Add a shared collector for any unmatched traffic from the virtual port and send it to a GigaStream.</p>	<ol style="list-style-type: none"> 1. Select Maps > Maps > Maps. 2. Configure the map.

Task	Description	UI Steps
		<ul style="list-style-type: none"> • Type s_coll_hd8 in the Alias field • Select Second Level for Type. • Select Collector for Subtype • Select the virtual port vp-hd8scale-4engines-slots1and3 for the Source. • Select GigaStream hd4-gs-4 for the Destination. <p>3. Click Save.</p>

Display Statistics

To display the GigaSMART Group statistics, select **GigaSMART > GigaSMART Groups > Statistics**.

Refer to [GigaSMART Group Statistics Definitions](#) for descriptions of the statistics.

GTP Stateful Session Recovery

Required License: GTP Filtering & Correlation

GTP sessions can be backed up periodically so they can then be recovered faster after a GigaSMART line card reboot or a node reboot. GTP stateful session recovery provides session persistence for GigaSMART GTP applications, including GTP flow filtering, GTP whitelisting, and GTP flow sampling.

GTP stateful session recovery requires additional memory for storing backups. GigaVUE-HC3 has the required memory. For GigaVUE-HC2, Control Card version 2 (HC2 CCv2) is required. Contact your Sales representative or authorized partner for the required control cards for GigaVUE-HC2.

Using GTP stateful session recovery, the GTP session tables in the GigaSMART line card memory will be periodically backed up to the control card memory on the node and stored.

You can configure an interval for how often the backups occur, such as every 10 minutes. If GTP stateful session recovery is enabled and the GigaSMART line card is rebooted, the GTP session tables will be restored automatically following the reboot.

The last stored backup file will be downloaded from the control card to the GigaSMART line card using FTP. The session table will be repopulated from the last stored backup file to each GigaSMART engine, up to 8 engines. Packet count statistics for sessions are saved and will also be restored.

Depending on the size of the session table, the amount of time to restore from the backup might take as much as 3 minutes. During that interval, traffic will be blocked to the virtual port on the GigaSMART line card. Once the session table is read and populated, traffic will be allowed.

Depending on the interval between backups, there could be differences between the stored state and the current state of the system, for example, map configuration could change, or sessions could be added, modified, or deleted.

Load balancing information is not persisted, so after a session table is repopulated, a session that was once sent to one load balanced port may be sent to a different load balanced port after the reboot. However, for IMSI-based load balancing, the traffic might be sent to the same port as it was before the reboot.

GTP stateful session recovery works in a cluster environment; however, the cluster master must remain the same.

To enable GTP persistence, as well as to configure timers, use the GTP Persistence fields under GigaSMART Parameters on the GigaSMART Group configuration page shown in [Figure 389: GTP Persistence GigaSMART Parameters](#) and select **GTP Persistence**. The timers are preconfigured with default values.



Figure 389: GTP Persistence GigaSMART Parameters

Use the **System** widget on the Overview page to determine the amount of memory. The size of memory will be 24Gb in an upgraded system. To view the System information, select **Overview** from the Navigation pane. The amount of free and used memory is displayed in the **Memory** field.

To see backup and restore information for GTP Persistence, select **GigaSMART > GigaSMART Groups > GigaSMART Groups**, and then click on the alias of the GigaSMART group. A Quick View opens for the selected GigaSMART group. Scroll down to GTP Persistence. In [Figure 390: GTP Persistence Information](#), GigaSMART Group gsgrp-1_4_e1 is selected and the Quick View displayed.

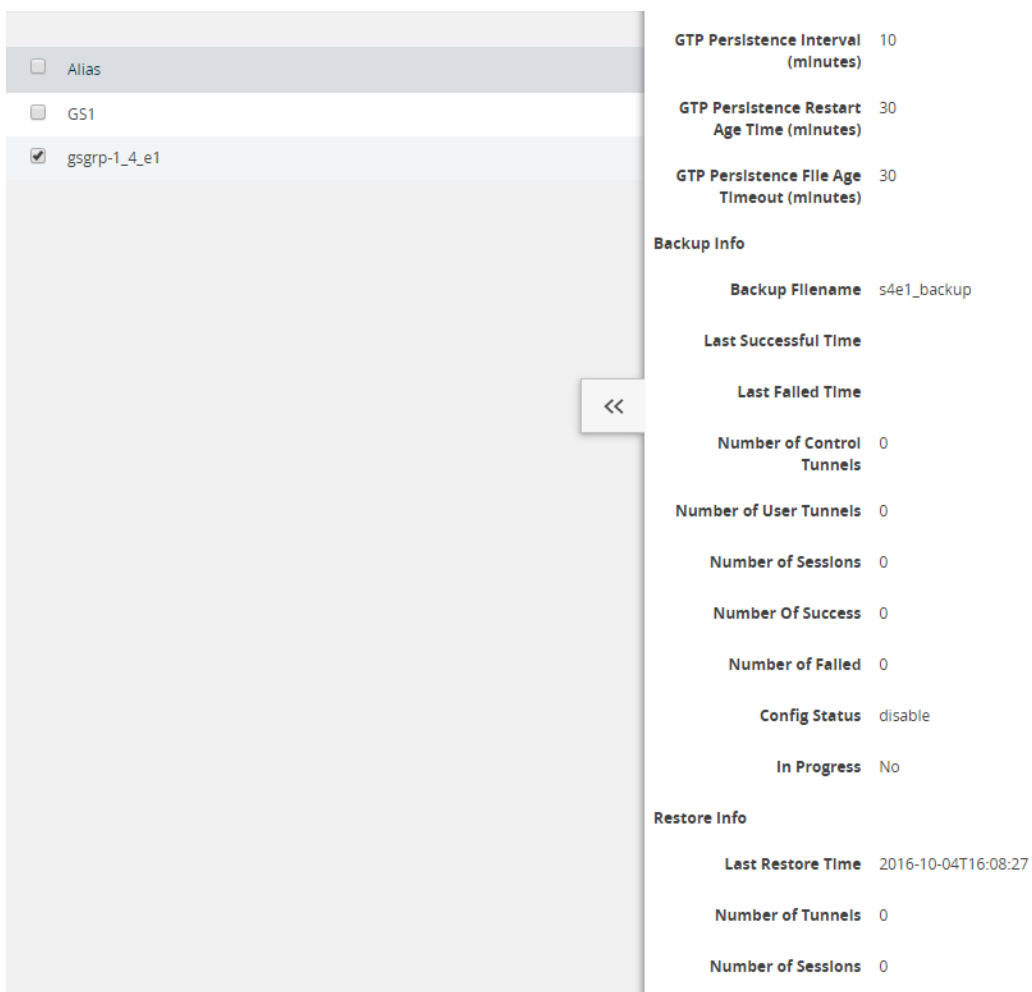


Figure 390: GTP Persistence Information

The following table describes persistence information.

Table 60: GigaSMART GTP Persistence Information

Name	Format
Backup Info	
Backup filename	The internal name of the backup file.
Last successful time	The timestamp of the last successful backup.
Last fail time	The timestamp of the last failed backup.
Number of control tunnels	The number of control tunnels backed up.
Number of user tunnels	The number of user tunnels backed up.
Number of sessions	The number of sessions backed up.

Name	Format
Number of success	The number of successful backups.
Number of failed	The number of failed backups.
Config Status	The status of a backup, which will be either Enabled or Disabled.
In Progress	The progress, which will be either Yes or No.
Restore Info	
Last restore time	The timestamp of the last restore.
Number of tunnels	The number of tunnels restored.
Number of sessions	The number of sessions restored.

To delete backup files, select the alias of GigaSMART Group and click **Edit**. Scroll down to GTP Persistence (refer to [Figure 391: GTP Backup Files Delete](#)) and click **Delete All** under **GTP Backup Files**.

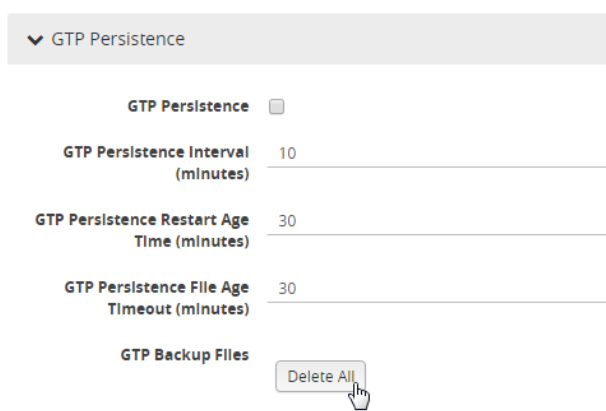


Figure 391: GTP Backup Files Delete

Traffic Intelligence

Designed to serve a wide variety of network operations environments, these GigaSMART operations provide complete network visibility to increase the efficiency of network performance tools.

Traffic Intelligence	
Adaptive Packet Filtering	<ul style="list-style-type: none"> GigaSMART Adaptive Packet Filtering (APF)
Advanced Load Balancing	<ul style="list-style-type: none"> GigaSMART Load Balancing

De-Duplication	<ul style="list-style-type: none"> • GigaSMART De-Duplication
Flow Masking	<ul style="list-style-type: none"> • GigaSMART MPLS Traffic Performance Enhancement
Header Stripping	<ul style="list-style-type: none"> • GigaSMART Header Addition • GigaSMART Header Stripping
Masking	<ul style="list-style-type: none"> • GigaSMART Masking
NetFlow Generation	<ul style="list-style-type: none"> • GigaSMART NetFlow Generation
Slicing	<ul style="list-style-type: none"> • GigaSMART Enhanced Slicing • GigaSMART Packet Slicing
SSL/TLS Decryption	<ul style="list-style-type: none"> • GigaSMART Out-of-Band SSL Decryption • GigaSMART SSL Decryption for Inline and Out-of-Band Tools • NCipher HSM for SSL Decryption for Out-of-Band Tools
Tunneling	<ul style="list-style-type: none"> • GigaSMART Custom Tunnel Decapsulation • GigaSMART ERSPAN Tunnel Decapsulation • GigaSMART IP Encapsulation (GigaSMART Tunnel) • GigaSMART IP Encapsulation/Decapsulation (GigaSMART Tunnel) • GigaSMART Layer 2 GRE Tunnel Encapsulation/Decapsulation • IP Fragmentation and Reassembly on L2GRE and GMIP Tunnels • GigaSMART VXLAN Tunnel Decapsulation

GigaSMART Adaptive Packet Filtering (APF)

Required License: Adaptive Packet Filtering

Adaptive Packet Filtering (APF) provides filtering on specific encapsulation protocol parameters. Additionally, it has the ability to look beyond the encapsulation protocol parameters into the original (encapsulated) data packet, to filter on source and destination IP or Layer 4 port numbers. APF offers the ability to look for content anywhere in the data packet and make intelligent filtering and forwarding decisions.

Adaptive Packet Filtering includes fragmentation awareness whereby all IP fragments associated with the filtered data packet are always forwarded allowing a complete view of the traffic stream for accurate analytics. APF also provides a powerful filtering engine that identifies content (based on patterns) across any part of the data packet, including the data packet payload.

APF filters packet-by-packet, but does not have the concept of sessions. For Application Session Filtering (ASF) and packet buffering on ASF, refer to [Application Session Filtering with Buffering](#).

APF operations can be assigned to GigaSMART groups consisting of multiple engine ports. Refer to [Groups of GigaSMART Engine Ports](#) for details.

In APF second level maps, a maximum of five (5) maps can be attached to a virtual port (vport). Each map can contain up to 25 gsrules.

Adaptive Packet Filtering (APF) goes deeper into packets to search for a condition, then filter and forward packets to tools, as follows:

- [Content-based Filtering](#)
- [Encapsulation Awareness](#)
- [Pattern Matching](#)

Implement APF Through the UI

To create vports through the UI and implement APF, do the following:

1. Select the **GigaSMART > GigaSMART Groups > GigaSMART Groups**, and click **New**.
2. On the GigaSMART Group page, select an available engine ports in the Port List field to associate group with one of the available engine ports.

You can associate the GigaSMART Group with one or multiple eports. For APF, no GigaSMART parameters are required unless combined with other gsops.

3. From the device view, select **GigaSMART > Virtual Ports**, and then click **New**.
4. On the Virtual Ports page, enter an alias and select the GigaSMART groups created in Step1, and then click **Save**.
5. To enable the APF operation, do the following:
 - a. From the device view, select **GigaSMART > GigaSMART Operations (GSOP) > GigaSMART Operation**.
 - b. On the GigaSMART Operations page, enter an alias in the **Alias** field
 - c. In the **GigaSMART Groups** drop-down list, select the GigaSMART group from step 1.
 - d. From the **GigaSMART Operations (GSOP)** list, select **Adaptive Packet Filtering** and select

Enabled.

- e. Click **Save**.

Once APF is enabled, maps can be created that the APF and the virtual port.

6. Create the first level map with virtual port created in step 2 as the destination and without applying a GigaSMART Operation.

The screenshot shows the configuration interface for a first-level map. The 'Map Info' section includes:

- Map Alias:** apflevel1
- Comments:** (empty text field)
- Type:** First Level
- Sub Type:** By Rule

The 'Map Source and Destination' section includes:

- Port Editor:** (button)
- Source:** (network) 1/1/x3
- Destination:** (vports) vp1
- GSOP:** None

7. Create a second level map with the APF GigaSMART operation, the virtual port as the source, and a rule. The following figure shows an example.

The screenshot shows the configuration interface for a second-level map. The 'Map Source and Destination' section includes:

- Port Editor:** (button)
- Type:** Second Level
- Sub Type:** By Rule
- Source:** (vports) vp1
- Destination:** (tool) 1/1/x4
- GSOP:** apf-gsop (gsgrp1)

The 'Map Rules' section includes:

- Add a Rule:** (button)
- Rule 1:** (empty text field) with radio buttons for **Pass** (selected) and **Drop**.
- IP Version:** 1 and v4

This completes the process to create an APF GigaSMART operation and corresponding rules. To learn more about the rules applicable for APF, see following sections.

Content-based Filtering

Content-based filtering is based on packet contents beyond Layer 2, 3, and 4 headers. The following four groups of attributes of rules in a map support content-based filtering.

The first group of attributes has the following format:

`<attribute> <address> <cidr>|<mask>`

The first group of attributes that use this format are as follows:

- ipv4 src and dst
- ipv6 src and dst
- mac src and dst

The following figure shows the attributes as displayed in the UI.

Map Rules

Quick Editor Import Add a Rule

× Rule 1 Condition search... Pass Drop Bi Director

MAC Source ×
Mac Address / Mac Mask

MAC Destination ×
Mac Address / Mac Mask

IPv4 Source ×
IPv4 Address
Cidr(1-32) or Net Mask

IPv4 Destination ×
IPv4 Address
Cidr(1-32) or Net Mask

IPv6 Source ×
IPv6 Address
Cidr(1-128) or Net Mask

IPv6 Destination ×
IPv6 Address
Cidr(1-128) or Net Mask

The second group of attributes has the following format:

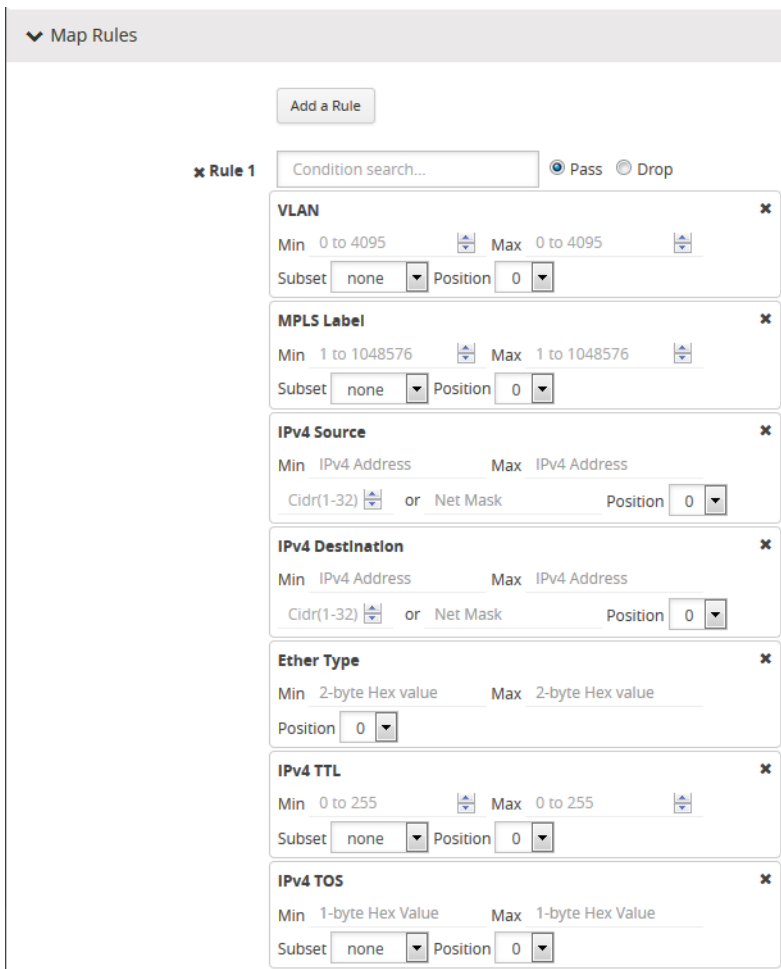
`<attribute> min <value> max <value> subset <odd|even|none> pos`

The second group of attributes that use this format are as follows:

- vlan id
- mpls label

- I4port src and dst
- ethertype
- ipv4 ttl, tosva, and protocol
- ipv6 flow-label
- vntag dvifid, svifid, and viflistid

The following figure shows the attributes as displayed in the UI.



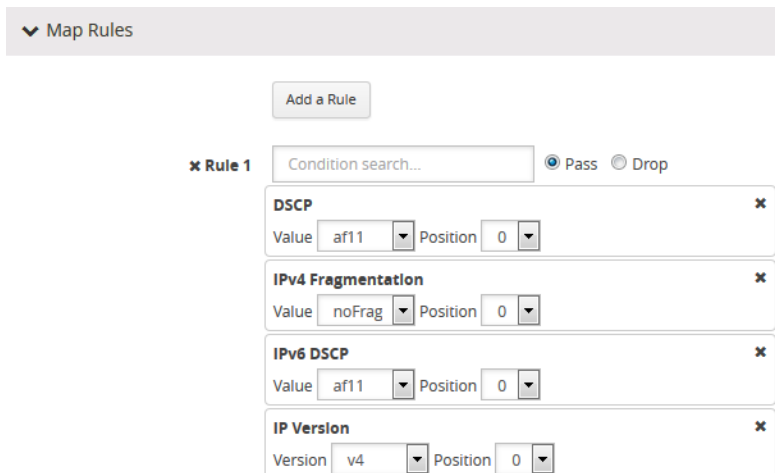
The third group of attributes has the following format: <value> <position>

`<attribute> value <value> pos <0|1|..|n>`

The third group of attributes that use this format are as follows:

- ipv4 dscp and frag
- ipv6 dscp
- ipver

The following figure show the attributes as displayed in the UI.



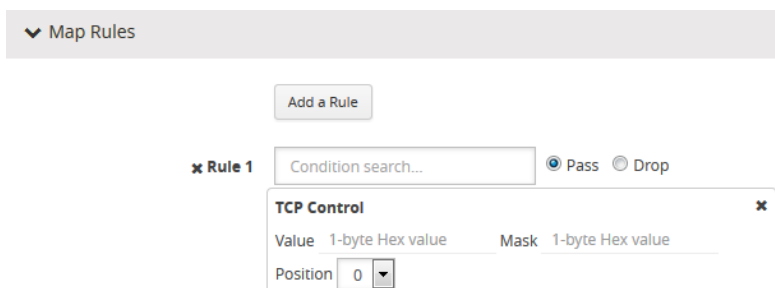
The fourth group of attributes has the following format:

`<attribute> value <value> mask <mask> pos <0|1|2|3>`

The fourth group of attribute that uses this format is as follows:

- tcp ctl

The following figure shows the attribute as displayed in the UI.



The maximum occurrences of each attribute supported are as follows:

Attribute	Maximum Occurrences
Attributes in IPv4 header	3
Attributes in IPv6 header	3
Attributes in MAC header	3
VLAN ID	4
MPLS label	4

Attribute	Maximum Occurrences
Attributes in L4port	3
Ethertype	6
Attributes in VNTag header	3
Attributes in TCP header	3
IP ver	3

Encapsulation Awareness

Encapsulation awareness offers filtering across advanced encapsulation headers, including GTP tunnel ID, VXLAN ID, ERSPAN ID, and GRE key.

The following attributes of rules in a map support encapsulation awareness:

1. Enter a GTP tunnel identifier as a four-byte hex value, either a range or a single value.
2. Enter a VXLAN ID as a three-byte hex value, either a range or a single value.
3. Enter an ERSPAN ID as a decimal value from 1~1024, either a range or a single value using the corresponding arguments.
4. Enter a GRE key as a four-byte hex value, either a range or a single value.

▼ Map Source and Destination

Port Editor

Source (vports) vp2 ✕

Destination (tool) 2/2/x1 ✕

GSOP testsapf (gs2port1) ▼

▼ Map Rules

Add a Rule

✕ Rule 1 Pass Drop

Ersparn Id ✕

1-1024 to 1-1024 none ▼

Gre Key ✕

4-byte Hex Value to 4-byte Hex Value none ▼

VxLAN Id ✕

0 - 16777215 to 0 - 16777215 ▼

Gtpute Id ✕

4-byte Hex Value to 4-byte Hex Value ▼

Pattern Matching

Use APF to create pattern matching filters in which the pattern is a particular sequence of data bytes at a variable or fixed offset from the start of a packet. Thus you can filter on any data patterns within a packet.

Pattern matching identifies content based on patterns in any part of the packet, including the payload. Patterns can be a static string at a user configured offset or a subset of Perl Compatible Regular Expression (PCRE) at a variable offset.

The Pattern Match attribute in a map rule supports pattern matching.

Multiple pattern matches are supported. A map can have multiple gsrules, each rule can have a pattern matching expression, and a single packet can match multiple rules.

The Pattern Match attribute in a map rule is shown in [Figure 392: Use Pattern Match Under Maps for Pattern Matching](#).

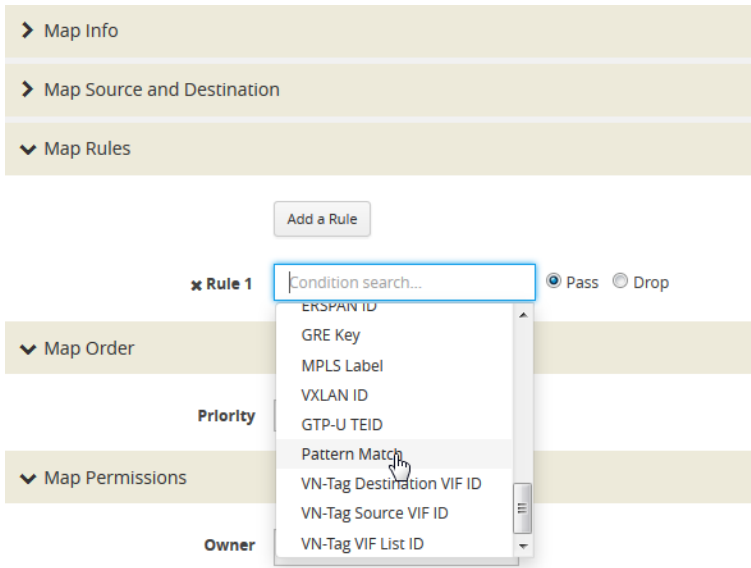


Figure 392: Use Pattern Match Under Maps for Pattern Matching

After selecting pattern matching for the rule, you can enter a Perl-compatible regular expression or a string to be used as a filter when pattern matching. For example to pass all packets including the string `www.gigamon.com` select **string** as type for the pattern match as shown in [Figure 393: Pattern Match with Type String](#).

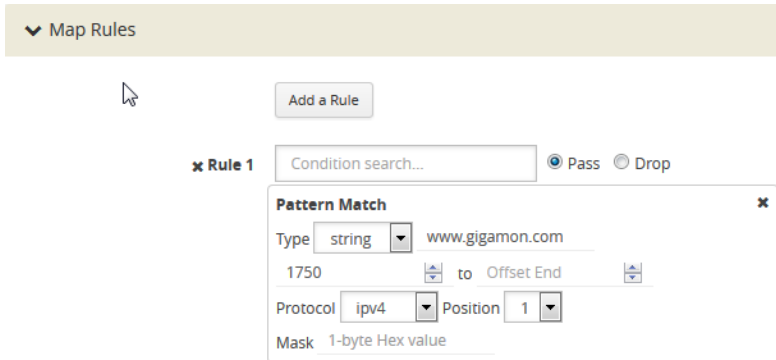


Figure 393: Pattern Match with Type String

To pass packets that match any phone number in the `nnn-nnn-nnn` format, select **regex** for the pattern match type and enter the following regular expression in the value field: `\d{3}-d{3}-d{3}` as shown in [Figure 394: Pattern Match with Type RegEx](#).

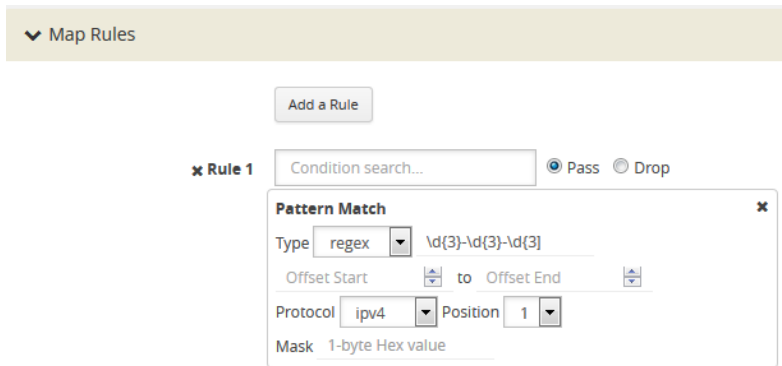


Figure 394: Pattern Match with Type RegEx

The offset is a value or range from 0 to 1750. The offset indicates where the pattern under search is located, specify, a value to indicate that the pattern has to start at that offset in the packet in order to be considered a match. Specify a range (beginning and ending) to indicate that the pattern can be anywhere in the packet in that range.

The optional protocol argument of the Pattern Match specifies that the matching will start after the protocol header specified in the command (IPv4, IPv6, TCP, or UDP). Pos 1 or 2 indicates the position. For example, position 2 indicates that matching is to start after the second protocol header. The offset and start and end values are also counted after the protocol header.

For example, to mask an SSL client hello packet pattern starting from the first position after the TCP header with an offset of 0 (located right after the TCP header), you define the pattern match rule as shown in [Figure 395: Pattern Match for SSL Client Hello Packet](#).

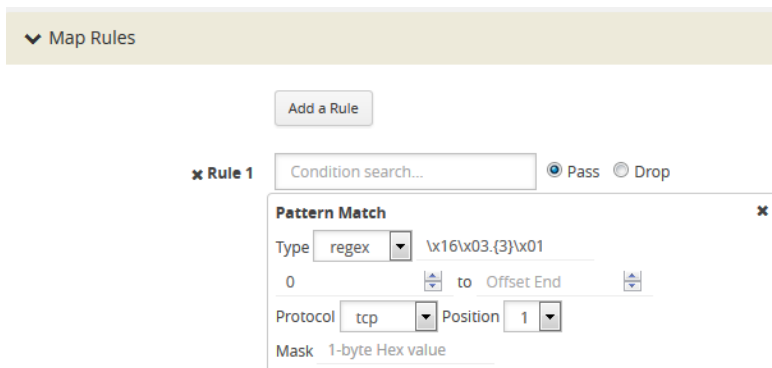


Figure 395: Pattern Match for SSL Client Hello Packet

Masking with Pattern Matching

APF allows masking when there is a match through pattern matching. Use masking with pattern matching to mask out a specific portion of a packet due to security reasons or to hide sensitive information in packets.

Multiple pattern matches are supported in a map. If there is masking associated with a rule and a packet matches multiple rules, the masking action is enforced for all the matching rules in the map.

The mask specifies that the matched pattern in the gsrule will be masked with the pattern specified in the 1-byte masking pattern.

The pattern specified in the gsrule will be overwritten. The overwritten length is the length of the matching pattern specified in either a string or a RegEx pmatch. Use the 1-byte to overwrite the original pattern match pattern. If there are multiple matches in the packet, up to 10 matches will be masked.

For example, to find Social Security numbers in the format xxx-xx-xxxx, between offset 40 and 80 and replace them with zeros, create a map with a pass rule in a Second Level byRule map with the regular expression `\d{3}-?\d{2}-?\d{4}` and a mask with a 1-byte masking value of 0 as shown in [Figure 396: Map Rule with RegEx for Masking SSNs](#).

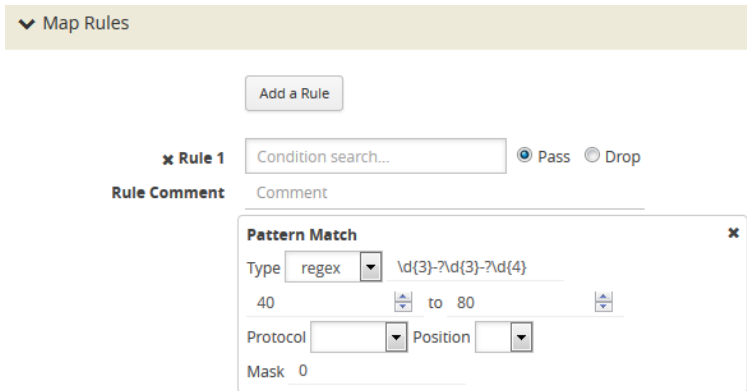


Figure 396: Map Rule with RegEx for Masking SSNs

Pattern Matching Hint

To optimize APF pattern matching performance in second level maps with gsrules, you can optionally use a pattern matching hint. Refer to the example in [Figure 397: Pattern Match with Hint](#).

The screenshot shows the configuration interface for GigaSMART Operations (GSOP). At the top, there is a 'Destination' dropdown menu set to '1/2/3/5' and a 'GigaSMART Operations (GSOP)' dropdown menu set to 'asf-grop (Sip)'. Below this is a 'Map Rules' section with a 'Map Rules' header and an 'Add a Rule' button. Underneath, 'Rule 1' is configured with a 'Condition search...' dropdown, radio buttons for 'Pass' and 'Drop', and a 'Rule Comment' field. A 'Pattern Match' dialog box is open, showing the following configuration: Type: 'string', sample: 'sample', 0 to Offset End, Protocol: (empty), Position: (empty), Mask: '1-byte Hex value', Hint: 'hello', From To: 'matchStartToMatchEnd', Start Of Match Offset: '1', and End Of Match Offset: '2'.

Figure 397: Pattern Match with Hint

The addition of the hint leads to two levels of filtering. First, the packet is subjected to a check for the simpler match comprising "gamon|GIM". If a match is found, a second level check for a match in the complete RegEx, "a[gG]igamon|aGIMO\\s[a-f]\\d{4}", is performed.

A hint must be selected so that all the packets that are expected to match the actual RegEx must have that string in them, otherwise the first level check will not be cleared. The hint in the example, "gamon|GIM", was selected because a packet containing either "gamon" or "GIM" in it is a potential match to the actual RegEx.

Best Practices of Pattern Matching Hint

The pattern matching hint is optional and, to optimize performance, it should be specified for all gsrules in a map. In that map, its usage is all or none, meaning you cannot have a mix of gsrules with some having the pattern matching hint and others not. However, if there are two maps, one map can have gsrules that include the pattern matching hint, while the other map can have gsrules that do not.

The use of the pattern matching hint improves performance in complex RegEx patterns involving "lookbehind" and "lookahead" constructs of PCRE syntax. Using them in conjunction with maps with simple patterns, such as fixed length string, is not advisable as it might lead to performance degradation in some cases. Since the RegEx rule set is limitless, there are no specific rules in which the degradation happens. A best practice is to try out both options, with and without the pattern matching hint, to find out what works best.

The rule of thumb while constructing the pattern matching hint is to keep it as simple as possible. Also, it must be a subset of the configured RegEx pattern. First, try out a 3 to 6 character-wide hint. If that does not provide the necessary scale, you can make the hint wider and more specific to prevent false positives. A maximum length of 63 bytes is supported.

Cross-Packet Pattern Matching

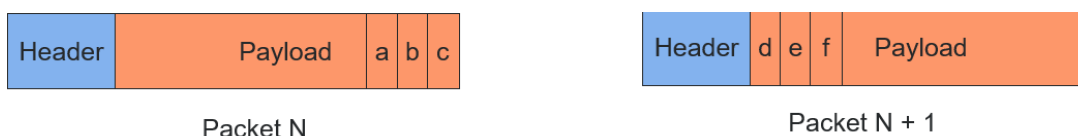
Cross-packet pattern matching refers to a scenario where a match initiates in one packet and ends in a subsequent packet. Starting with Gigamon software release 5.4 this feature enhancement extends the support for GSOP cross packet pattern spanning two packets.

Cross packet matching applies to connection oriented exchanges only and available for 5-tuple flows. Cross packet matching scan will be performed on frames with the following header encapsulations:

- IPv4/TCP, IPv4/UDP
- IPv6/TCP, IPv6/UDP
- IPv4/IPv6/TCP, IPv4/IPV6/UDP
- IPV6/IPv4/TCP, IPV6/IPv4/UDC

Every packet of a flow is subjected to pattern matching scan starting with the inner most L4 payload section. For example, 5-tuple TCP session with nested TCP layer will position the scan starting from start of innermost TCP payload to the end of frame. Bi-directional flow maintains match context for each direction separately and this feature supports up to 1Million flows.

The figure below illustrates the Cross-packet pattern matching concept where the pattern search “**abcdef**” spans two packets.



Enable/Disable Cross-packet Matching

You can enable or disable Cross-packet pattern matching from the GigaSMART GSOP operation.

1. Select a Physical Node.
2. **GigaSMART > GigaSMART > GigaSMART Groups.**
3. Click **New**. The GigaSMART Group parameter page displays.

▼ GigaSMART Group Info

Alias _____

Port List

▼ GigaSMART Parameters

▼ Cross Packet Match

Enable Cross Packet Match

▼ Resource Buffer

Enable Resource Packet Buffer

Resource Packet Buffer Overload Threshold (%)

Enable Resource CPU

Resource CPU Overload Threshold (%)

ASF (Application Session Filtering)

Cross Packet Match Flows (x100K) 0 is disabled

4. Click the **Enable Cross-packet Match** check box to enable.
5. Enter a range from 1 to 10 for the **Cross Packet Match Flows** parameter. Each unit is 100K bi-directional flows.
6. Click **OK**.

NOTE: When disabling this functionality you will be notified that change will be effective only after chassis or GigaSMART card reboot.

Disable Cross Packet Matching

1. Repeat Steps 1 through 3 from the "Enabling Cross Packet Matching" task.
2. Uncheck the **Enable Cross-packet Match** check box to disable this functionality.
3. Click **OK**.

View Cross-packet Matching

1. Select a Physical Node.
2. **GigaSMART > GigaSMART > GigaSMART Groups**.
3. Select a Group.
4. Click **Edit**. The GigaSMART Group parameters including cross pattern match details pane displays.

Limitations

The following constraints exist with this functionality.

- Cannot coexist with other GSOPs on same gsgroup.
- Only one second level map is allowed for each vport attached to the gsgroup.
- Disabling the feature requires a GigaSMART card reboot.

Map Statistics

Go to **Map > Statistics** to display counts of the rules that actually matched in a map. A single packet can match one or more rules. For example, if a single packet matches multiple rules in an APF map, all matching rules will have that packet counted against them and the overall map status pass counter will show 1.

APF Examples

The following are APF examples:

- [Identify Social Security Numbers in User-Level Transactions](#)
- [Mask Social Security Numbers](#)
- [Filter on Fiber Channel over Ethernet \(FCOE\) Traffic](#)
- [Multi-Encapsulation Filtering](#)
- [Filter on Subscriber Device IP \(User-Endpoint IP or UE-IP\)](#)
- [Filter on Inner Layer 2-4 Parameters for Unrecognized Headers](#)
- [GTP Tunnel ID-Based Filtering](#)
- [ERSPAN Tunneling](#)
- [Distribute Traffic Based on Inner IP Addresses and Inner TCP Port Values](#)
- [MPLS Label Based Filtering](#)
- [Combine APF with GigaSMART Operations](#)
- [Conditional Header Stripping](#)
- [Facilitate Overlapping Rules](#)

Identify Social Security Numbers in User-Level Transactions

The following example looks for packets containing Social Security Numbers in an incoming traffic stream using pattern matching. Once a match is detected, the packets are forwarded to a monitoring tool for additional analysis.

Task	Description	UI Steps
1	Configure one network and two tool	1. Select Ports > Ports > All Ports.

Task	Description	UI Steps
	ports.	<ol style="list-style-type: none"> 2. Click Quick Port Editor. 3. Configure one network port and two tool ports. For example, select Network for port 1/1/x3. Select Tool for port 1/1/x4 and port 1/1/x1. 4. Select Enable for each port. 5. Click OK. 6. Close the Quick Port Editor.
2	Configure a GigaSMART group and associate it with a GigaSMART engine port.	<ol style="list-style-type: none"> 1. From the device view, select GigaSMART > GigaSMART Groups > GigaSMART Groups. 2. Click New. 3. Type gsgrp1 in the Alias field. 4. Click Save.
3	Configure the GigaSMART operation.	<ol style="list-style-type: none"> 1. From the device view, select GigaSMART > GigaSMART Operations (GSOP) > GigaSMART Operation. 2. Click New. 3. Type gsfil in the Alias field. 4. Select gsgrp1 from the GigaSMART Groups list. 5. Select APF from the GigaSMART Operations (GSOP) list. 6. Select Enable. 7. Click Save.
4	Create a virtual port.	<ol style="list-style-type: none"> 1. From the device view, select GigaSMART > Virtual ports. 2. Click New. 3. Enter vp1 in the Alias field. 4. Select gsgrp1 from the GigaSMART Groups list. 5. Click Save.
5	Create a first level map to forward traffic from network port 1/1/x3 to virtual port vp1.	<ol style="list-style-type: none"> 1. Select Maps > Maps > Maps. 2. Click New. 3. Configure the map. <ul style="list-style-type: none"> • Enter map1 in the Alias field. • Select First Level for Type. • Select By Rule for Subtype. • Select the port 1/1/x3 for the Source. • Select the virtual port vp1 for the Destination. 4. Add a rule. <ol style="list-style-type: none"> a. Click Add a Rule. b. Select Pass.

Task	Description	UI Steps
		<ol style="list-style-type: none"> c. Select IP Version. d. Select v4 for Version. <p>5. Click Save.</p>
6	Create a second level map to forward traffic from the virtual port vp1 to GigaSMART with pattern matching.	<ol style="list-style-type: none"> 1. Select Maps > Maps > Maps. 2. Click New. 3. Configure the map. <ul style="list-style-type: none"> • Enter map2 in the Alias field. • Select Second Level for Type. • Select By Rule for Subtype. • Select the virtual port vp1 for the Source. • Select the tool port 1/1/x1 for the Destination. 4. Add a rule. <ol style="list-style-type: none"> a. Click Add a Rule. b. Select Pass. c. Select Pattern Matching. d. Select regex for Type and enter the value <code>d{3}-?d{2}-?d{4}</code>. e. Set the Offset Start to 40. f. Set the Offset End to 80 7. Click Save.

Mask Social Security Numbers

In the following pattern matching example, IPv4 packets contain Social Security Numbers (SSNs) in the format xxx-xx-xxxx. If the SSNs are between offset 40 and 80, they will be replaced with zeros.

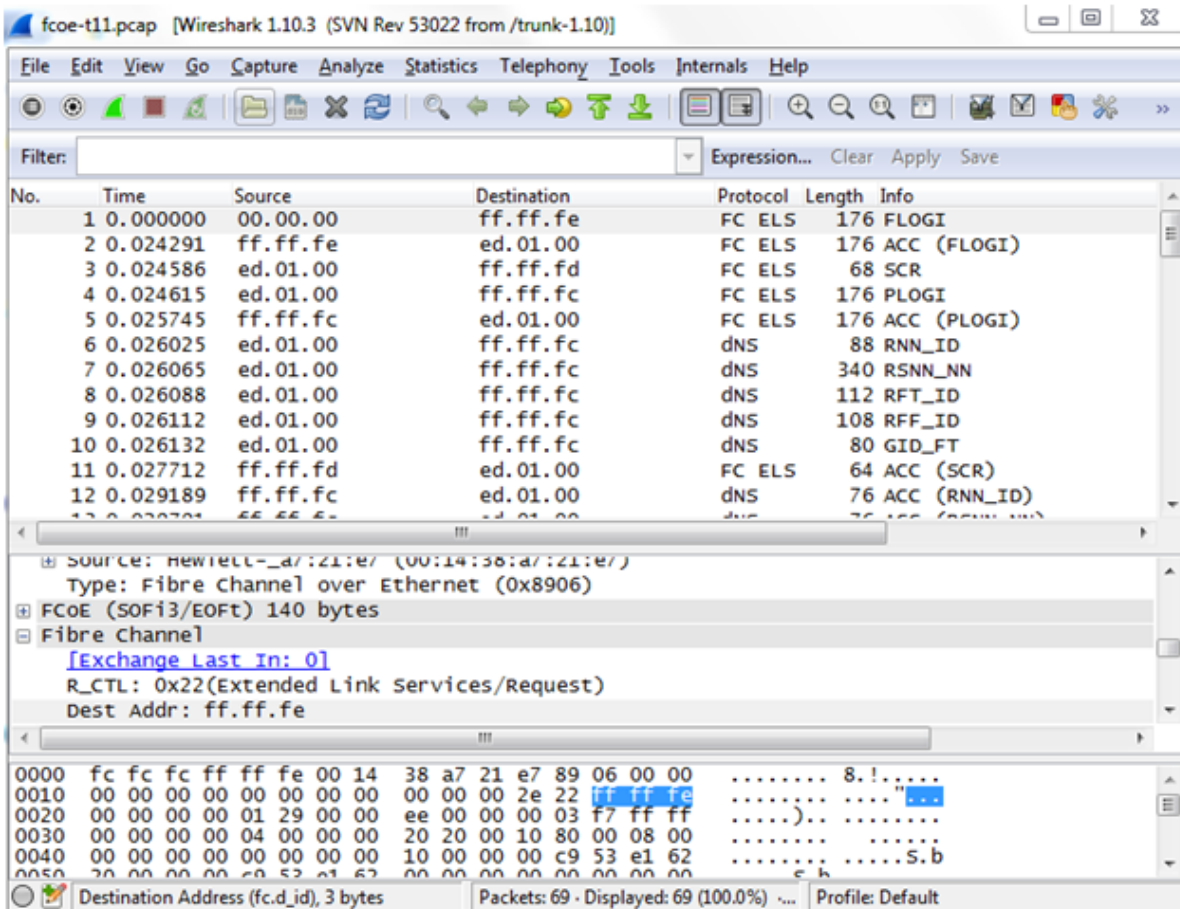
Task	Description	UI Steps
1	Configure a GigaSMART group and associate it with a GigaSMART engine port.	<ol style="list-style-type: none"> 1. From the device view, select GigaSMART > GigaSMART Groups > GigaSMART Groups. 2. Click New. 3. Type gsgrp1 in the Alias field. 4. Click Save.
2	Create a virtual port and associate it with the GigaSMART group.	<ol style="list-style-type: none"> 1. From the device view, select GigaSMART > Virtual ports. 2. Click New. 3. Enter gsTraffic in the Alias field.

Task	Description	UI Steps
		<ol style="list-style-type: none"> 4. Select gsgroup1 from the GigaSMART Groups list. 5. Click Save.
3	Create a first level map to direct traffic from network port 1/1/x1 to virtual port gsTraffic.	<ol style="list-style-type: none"> 1. Select Maps > Maps > Maps. 2. Click New. 3. Configure the map. <ul style="list-style-type: none"> • Enter map1 in the Alias field. • Select First Level for Type. • Select By Rule for Subtype. • Select the port 1/1/x3 for the Source. • Select the virtual port gsTraffic for the Destination. 4. Add a rule. <ol style="list-style-type: none"> a. Click Add a Rule. b. Select Pass. c. Select IP Version. d. Select v4 for Version. 5. Click Save.
4	Configure the GigaSMART operation.	<ol style="list-style-type: none"> 1. From the device view, select GigaSMART > GigaSMART Operations (GSOP) > GigaSMART Operations. 2. Click New. 3. Select gsgroup1 from the GigaSMART Groups list. 4. Select Adaptive Packet Filtering from the GigaSMART Operations (GSOP) list. 5. Select Enable. 6. Click Save.
5	Create a second level map to direct traffic from the virtual port gsTraffic to GigaSMART.	<ol style="list-style-type: none"> 1. Select Maps > Maps > Maps. 2. Click New. 3. Configure the map. <ul style="list-style-type: none"> • Enter map2 in the Alias field. • Select Second Level for Type. • Select By Rule for Subtype. • Select the virtual port vp1 for the Source. • Select the tool port 1/1/x6 for the Destination. • Select gsop1 from the GSOP list.

Task	Description	UI Steps
		<ol style="list-style-type: none"> 4. Add a rule. <ol style="list-style-type: none"> a. Click Add a Rule. b. Select Pass. c. Select Pattern Matching. d. Select regex for Type and enter the value <code>d{3}-?\d{2}-?\d{4}</code>. e. Set the Offset Start to 40. f. Set the Offset End to 80 g. Enter 0 for Mask. 8. Click Save.

Filter on Fiber Channel over Ethernet (FCOE) Traffic

The flexibility offered by regular expression-based filters can be used as an infrastructure to classify traffic streams with protocol headers that are typically unsupported on traditional TAP/SPAN aggregation devices. In this example, regular expression-based filters are used for filtering on the source address in a Fiber Channel header.

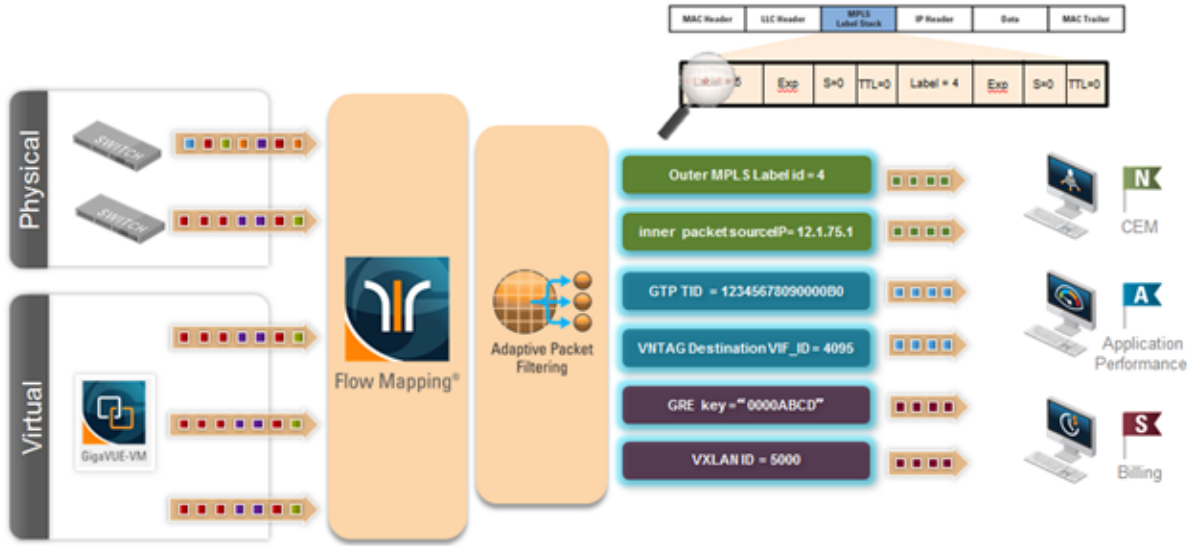


Task	Description	UI Steps
1	Configure ports.	<ol style="list-style-type: none"> 1. Select Ports > Ports > All Ports. 2. Click Quick Port Editor. 3. Configure one network port and two tool ports. For example, select Network for port 1/1/x3. Select Tool for port 1/1/x4 and port 1/1/x1. 4. Select Enable for each port. 5. Click OK. 6. Close the Quick Port Editor.
2	Configure a GigaSMART group and associate it with a GigaSMART engine port.	<ol style="list-style-type: none"> 1. From the device view, select GigaSMART > GigaSMART Groups > GigaSMART Groups. 2. Click New. 3. Type gsgrp1 in the Alias field. 4. Click Save.
3	Configure the GigaSMART operation.	<ol style="list-style-type: none"> 1. From the device view, select GigaSMART > GigaSMART Operations (GSOP) > GigaSMART Operation. 2. Click New. 3. Select gsfil from the GigaSMART Groups list. 4. Select Adaptive Packet Filtering from the GigaSMART Operations list. 5. Select Enable. 6. Click Save.
4	Create a virtual port and associate it with the GigaSMART group.	<ol style="list-style-type: none"> 1. From the device view, select GigaSMART > Virtual ports. 2. Click New. 3. Enter gsTraffic in the Alias field. 4. Select gsgrp1 from the GigaSMART Groups list. 5. Click Save.
5	Create a first level map to forward FCOE traffic to the virtual port.	<ol style="list-style-type: none"> 1. Select Maps > Maps > Maps. 2. Click New. 3. Configure the map. <ul style="list-style-type: none"> • Enter to_vp in the Alias field. • Select First Level for Type. • Select By Rule for Subtype. • Select the port 1/1/x3 for the Source. • Select the virtual port vp1 for the Destination. 4. Add a rule. <ol style="list-style-type: none"> a. Click Add a Rule.

Task	Description	UI Steps
		<ol style="list-style-type: none"> b. Select Pass. c. Select Ether Type d. Enter 8906 in the Value field. <p>5. Click Save.</p>
6	<p>Create a second level map to filter on regular expression, using a string match to the destination address in the FCOE packet.</p>	<ol style="list-style-type: none"> 1. Select Maps > Maps > Maps. 2. Click New. 3. Configure the map. <ul style="list-style-type: none"> • Enter map2 in the Alias field. • Select Second Level for Type. • Select By Rule for Subtype. • Select the virtual port vp1 for the Source. • Select the tool port 1/1/x1 for the Destination. • Select gsfil from the GSOP list. 4. Add a rule. <ol style="list-style-type: none"> a. Click Add a Rule. b. Select Pass. c. Select Pattern Match. d. Select string for Type and enter txff\xff\xfe. e. Set the Offset Start to 0. f. Set the Offset End to 29 g. Enter 0 for Mask. 8. Click Save.

Multi-Encapsulation Filtering

In order to complement the mobility brought about by the virtualized server infrastructure, network virtualization overlays like VXLAN, VNTag, NVGRE are being designed and implemented in Data Centers and Enterprise environment. Across Service Provider environments, huge volumes of traffic are being tunneled over GTP. Until now, the GigaVUE Visibility Platform provided the option of stripping out these headers, thus providing visibility to monitoring tools that do not understand these overlays and encapsulation protocol. With APF, this capability is further enhanced where operators now have the option of making forwarding decisions based on the encapsulation and inner packet contents.



With encapsulation awareness enabled by APF, operators have multiple options to act on the packet including the flexibility to:

- Filter on encapsulation header parameters, Layer 2 – 4 parameters in the outer or inner headers (up to 5 layers of encapsulation) in any combination. For example:
 - Forward traffic specific to a subset of VXLAN IDs to one or more monitoring tools.
 - Distribute traffic based on MPLS label values across one or more monitoring tools.
- In combination with header stripping:
 - Implement “conditional” header-stripping, based on encapsulation header parameters or inner/outer packet contents, as follows:
 - Forward a subset of traffic “as-is” to monitoring tools that need these encapsulations for analysis.
 - Alternatively, strip out the outer headers/encapsulations and distribute traffic to monitoring tools that do not require these outer headers for analysis.
- Since APF is implemented as a second level map, operators can also implement overlapping rules where:
 - A copy of the traffic can be distributed across a group of monitoring tools.
 - A refined subset from the same incoming stream is distributed across a different set of tools.

Filter on Subscriber Device IP (User-Endpoint IP or UE-IP)

Encapsulation awareness enabled by APF allows mobile operators to filter on Layer 2 – 4 header parameters found in an encapsulated packet.

This allows operators to filter and forward traffic specific to a mobile subscriber device or a group of subscriber devices, identified by their IP address (User-Endpoint IP) to one or more monitoring tools.

In this example, we are:

- Identifying and forwarding traffic from / to a UE-IP of 1.1.1.1 to a monitoring tool connected to 1/1/x1
- Identifying and forwarding traffic from / to a UE-IP of 1.1.1.2 to a different monitoring tool connected to tool port 1/1/x4

In many cases, the GTP control sessions are low-volume and are useful in providing some level of visibility in to the quality of experience of the subscribers. To this end, operators prefer to replicate the control sessions across all the monitoring tools, while filtering and forwarding a subset of the user-plane sessions to a subset of monitoring tools. The following example also illustrates configuration commands, leveraging the patented flow-mapping technology to replicate the GTP control sessions across all the monitoring tools involved in the traffic analysis.

Task	Description	UI Steps
1	Configure ports.	<ol style="list-style-type: none"> 1. Select Ports > Ports > All Ports. 2. Click Quick Port Editor. 3. Configure one network port and two tool ports. For example, select Network for port 1/1/x3. Select Tool for port 1/1/x4 and port 1/1/x1. 4. Select Enable for each port. 5. Click OK. 6. Close the Quick Port Editor.
2	Configure a GigaSMART group and associate it with a GigaSMART engine port.	<ol style="list-style-type: none"> 1. From the device view, select GigaSMART > GigaSMART Groups > GigaSMART Groups. 2. Click New. 3. Type gsg1 in the Alias field. 4. Select engine port 1/1/e1 in the Port List field. 5. Click Save.
3	Configure the GigaSMART operation.	<ol style="list-style-type: none"> 1. From the device view, select GigaSMART > GigaSMART Operations (GSOP) > GigaSMART Operations. 2. Click New. 3. Type gsfil in the Alias field. 4. Select gsg1 from the GigaSMART Groups list. 5. Select Adaptive Packet Filtering from the GigaSMART Operations (GSOP) list.

Task	Description	UI Steps
		<ol style="list-style-type: none"> 6. Select Enable. 7. Click Save.
4	<p>Create a virtual port and associate it with the GigaSMART group.</p>	<ol style="list-style-type: none"> 1. From the device view, select GigaSMART > Virtual ports. 2. Click New. 3. Enter vp1 in the Alias field. 4. Select gsggrp1 from the GigaSMART Groups list. 5. Click Save.
5	<p>Create a first level map to forward GTP-u traffic to the virtual port.</p> <p>NOTE: In the rule, 2152 is GTP-u traffic.</p>	<ol style="list-style-type: none"> 1. Select Maps > Maps > Maps. 2. Click New. 3. Configure the map. <ul style="list-style-type: none"> • Enter to_vp in the Alias field. • Select First Level for Type. • Select By Rule for Subtype. • Select the port 1/1/x3 for the Source. • Select the virtual port vp1 for the Destination. 4. Add a rule. <ol style="list-style-type: none"> a. Click Add a Rule. b. Select Pass. c. Select Port Source d. Enter 2152 for the port value. 5. Click Save.
6	<p>Create a first level map to forward GTP-c traffic to the tools.</p> <p>NOTE: In the rule, 2123 is GTP-c traffic.</p>	<ol style="list-style-type: none"> 1. Select Maps > Maps > Maps. 2. Click New. 3. Configure the map. <ul style="list-style-type: none"> • Type to_tool in the Alias field. • Select Regular for Type. • Select By Rule for Subtype. • Select the port 1/1/x3 for the Source. • Select port 1/1/x1 and port 1/1/x4 for the Destination. 4. Add a rule. <ol style="list-style-type: none"> a. Click Add a Rule. b. Select Pass.

Task	Description	UI Steps
		<ol style="list-style-type: none"> c. Select Port Source d. Enter 2123 for the port value. <p>5. Click Save.</p>
7	Create a second level map to filter on source and destination IP (bi-directional).	<ol style="list-style-type: none"> 1. Select Maps > Maps > Maps. 2. Click New. 3. Configure the map. <ul style="list-style-type: none"> • Enter map1 in the Alias field. • Select Second Level for Type. • Select By Rule for Subtype. • Select the virtual port vp1 for the Source. • Select the tool port 1/1/x1 for the Destination. • Select gsfil from the GSOP list. 4. Add Rule 1. <ol style="list-style-type: none"> a. Click Add a Rule. b. Select Pass. c. Select IPv4 Source. d. Enter 1.1.1.1 for the IPv4 Address e. Enter 255.255.255.255 for the Net Mask f. Set Position to 2. 7. Add a Rule 2. <ol style="list-style-type: none"> a. Click Add a Rule. b. Select Pass. c. Select IPv4 Destination. d. Enter 1.1.1.1 for the IPv4 Address e. Enter 255.255.255.255 for the Net Mask f. Set Position to 2. 7. Click Save.
8	Create another second level map to filter on source and destination IP (bi-directional).	<ol style="list-style-type: none"> 1. Select Maps > Maps > Maps. 2. Click New. 3. Configure the map. <ul style="list-style-type: none"> • Enter map1 in the Alias field. • Select Second Level for Type. • Select By Rule for Subtype. • Select the virtual port vp1 for the Source.

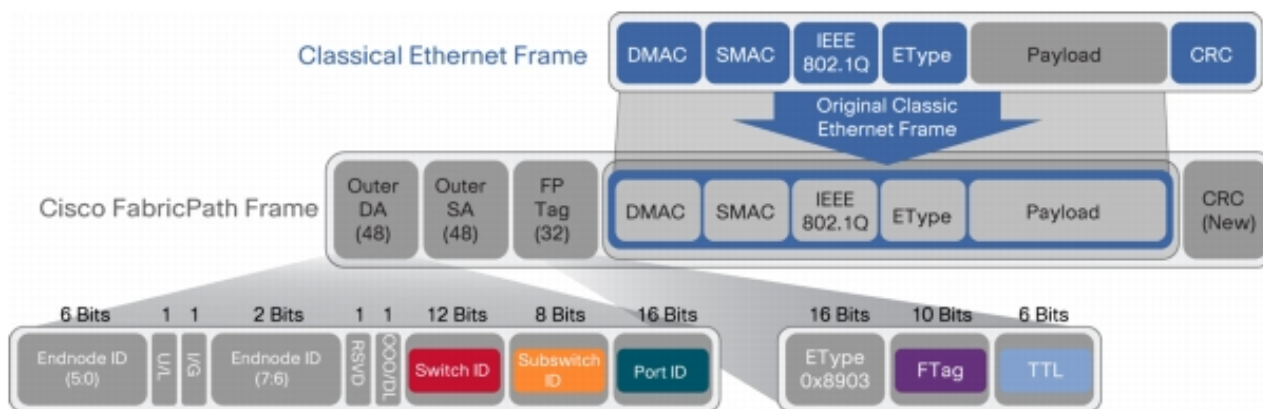
Task	Description	UI Steps
		<ul style="list-style-type: none"> • Select the tool port 1/1/x4 for the Destination. • Select gsfil from the GSOP list. <ol style="list-style-type: none"> 4. Add Rule 1. <ol style="list-style-type: none"> a. Click Add a Rule. b. Select Pass. c. Select IPv4 Source. d. Enter 1.1.1.1 for the IPv4 Address e. Enter 255.255.255.255 for the Net Mask f. Set Position to 2. 7. Add a Rule 2. <ol style="list-style-type: none"> a. Click Add a Rule. b. Select Pass. c. Select IPv4 Destination. d. Enter 1.1.1.1 for the IPv4 Address e. Enter 255.255.255.255 for the Net Mask f. Set Position to 2. 7. Click Save.

Filter on Inner Layer 2-4 Parameters for Unrecognized Headers

The flexibility of encapsulation awareness enables filtering on encapsulated contents even if APF does not recognize the outer encapsulation header. The following example illustrates a packet encapsulated in Fabric Path headers. Fabric Path headers (as shown in the figure) are mac-in-mac headers that are currently not recognized by APF. However operators can still filter and forward traffic flows based on Layer 2 – 4 parameters found in the encapsulated packets.

In this example, we are:

- Identifying and forwarding traffic from/to ip 1.1.1.1 in the inner / original packet to monitoring tool connected to tool port 1/1/x1
- Identifying and forwarding traffic from/to ip 1.1.1.2 in the inner / original packet to monitoring tool connected to tool port 1/1/x4



Task	Description	UI Steps
1	Configure ports.	<ol style="list-style-type: none"> 1. Select Ports > Ports > All Ports. 2. Click Quick Port Editor. 3. Configure one network port and two tool ports. For example, select Network for port 1/1/x3. Select Tool for port 1/1/x4 and port 1/1/x1. 4. Select Enable for each port. 5. Click OK. 6. Close the Quick Port Editor.
2	Configure a GigaSMART group and associate it with a GigaSMART engine port.	<ol style="list-style-type: none"> 1. From the device view, select GigaSMART > GigaSMART Groups > GigaSMART Groups. 2. Click New. 3. Type gsg1 in the Alias field. 4. Select engine port 1/1/e1 in the Port List field. 5. Click Save.
3	Configure the GigaSMART operation.	<ol style="list-style-type: none"> 1. From the device view, select GigaSMART > GigaSMART Operations (GSOP) > GigaSMART Operation. 2. Click New. 3. Type 4. Select gsfil from the GigaSMART Groups list. 5. Select Adaptive Packet Filtering from the GigaSMART Operations (GSOP) list. 6. Select Enable. 7. Click Save.
4	Create a virtual port and associate it with the GigaSMART group.	<ol style="list-style-type: none"> 1. From the device view, select GigaSMART > Virtual ports. 2. Click New. 3. Enter vp1 in the Alias field. 4. Select gsg1 from the GigaSMART Groups list.

Task	Description	UI Steps
		<ol style="list-style-type: none"> 5. Click Save.
5	Create a first level map to forward fabric path packets to the virtual port.	<ol style="list-style-type: none"> 1. Select Maps > Maps > Maps. 2. Click New. 3. Configure the map. <ul style="list-style-type: none"> • Enter to_vp in the Alias field. • Select First Level for Type. • Select By Rule for Subtype. • Select the port 1/1/x3 for the Source. • Select the virtual port vp1 for the Destination. 4. Add a rule. <ol style="list-style-type: none"> a. Click Add a Rule. b. Select Pass. c. Select Ether Type d. Enter 8903 in the Value field. 5. Click Save.
6	Create a second level map to filter on source and destination IP (bi-directional).	<ol style="list-style-type: none"> 1. Select Maps > Maps > Maps. 2. Click New. 3. Configure the map. <ul style="list-style-type: none"> • Enter map1 in the Alias field. • Select Second Level for Type. • Select By Rule for Subtype. • Select the virtual port vp1 for the Source. • Select the tool port 1/1/x1 for the Destination. • Select gsfil from the GSOP list. 4. Add Rule 1. <ol style="list-style-type: none"> a. Click Add a Rule. b. Select Pass. c. Select IPv4 Source. d. Enter 1.1.1.1 for the IPv4 Address e. Enter 255.255.255.255 for the Net Mask f. Set Position to 1. 7. Add a Rule 2. <ol style="list-style-type: none"> a. Click Add a Rule. b. Select Pass.

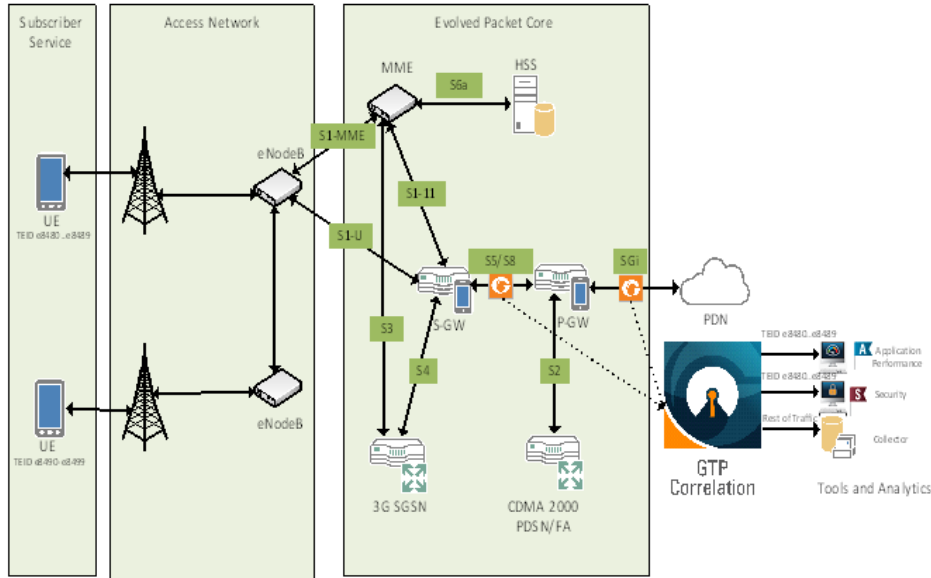
Task	Description	UI Steps
		<ul style="list-style-type: none"> c. Select IPv4 Destination. d. Enter 1.1.1.1 for the IPv4 Address e. Enter 255.255.255.255 for the Net Mask f. Set Position to 1. <p>7. Click Save.</p>
7	Create another second level map to filter on source and destination IP (bi-directional).	<ul style="list-style-type: none"> 1. Select Maps > Maps > Maps. 2. Click New. 3. Configure the map. <ul style="list-style-type: none"> • Enter map1 in the Alias field. • Select Second Level for Type. • Select By Rule for Subtype. • Select the virtual port vp1 for the Source. • Select the tool port 1/1/x4 for the Destination. • Select gsfil from the GSOP list. 4. Add Rule 1. <ul style="list-style-type: none"> a. Click Add a Rule. b. Select Pass. c. Select IPv4 Source. d. Enter 1.1.1.2 for the IPv4 Address e. Enter 255.255.255.255 for the Net Mask f. Set Position to 1. 7. Add a Rule 2. <ul style="list-style-type: none"> a. Click Add a Rule. b. Select Pass. c. Select IPv4 Destination. d. Enter 1.1.1.2 for the IPv4 Address e. Enter 255.255.255.255 for the Net Mask f. Set Position to 1. 7. Click Save.

GTP Tunnel ID-Based Filtering

The following example demonstrates filtering and forwarding traffic based on tunnel IDs included as part of the GTP user-plane messages. It also illustrates the concept of a shared collector to which traffic not matching any of the configured filters can be optionally sent. GTP control sessions are forwarded to all the monitoring tools leveraging the power of flow mapping by filtering on Layer-4 UDP port 2123.

For GTP-u:

- Filter and forward teid ranges 0x001e8480..0x001e8489 to a monitoring tool
- Filter and forward teid ranges 0x001e8490..0x001e8499 to another monitoring tool
- Forward the rest of the traffic to a shared collector



Task	Description	UI Steps
1	Configure one network and three tool type of ports.	<ol style="list-style-type: none"> 1. Select Ports > Ports > All Ports. 2. Click Quick Port Editor. 3. Configure one network port and two tool ports. For example, select Network for port 1/1/x9. Select Tool for the ports 1/1/x13, 1/1/x14, and 1/1/x15. 4. Select Enable for each port. 5. Click OK. 6. Close the Quick Port Editor.
2	Configure a GigaSMART group and associate it with a GigaSMART engine port.	<ol style="list-style-type: none"> 1. From the device view, select GigaSMART > GigaSMART Groups > GigaSMART Groups. 2. Click New. 3. Type gsg1 in the Alias field. 4. Select engine port 1/1/e1 in the Port List field. 5. Click Save.
3	Configure the GigaSMART operation and assign it to the GigaSMART group. Packets processed by this operation are evaluated	<ol style="list-style-type: none"> 1. From the device view, select GigaSMART > GigaSMART Operations (GSOP) > GigaSMART Operation. 2. Click New.

Task	Description	UI Steps
	using Adaptive Packet Filtering (APF) rules.	<ol style="list-style-type: none"> 3. Type gsfil in the Alias field. 4. Select gsg1 from the GigaSMART Groups list. 5. Select Adaptive Packet Filtering from the GigaSMART (GSOP) Operations list. 6. Select Enable. 7. Click Save.
4	Create a virtual port and associate it with the GigaSMART group.	<ol style="list-style-type: none"> 1. From the device view, select GigaSMART > Virtual ports. 2. Click New. 3. Enter vp1 in the Alias field. 4. Select gsg1 from the GigaSMART Groups list. 5. Click Save.
5	<p>Create a first level map that directs GTP-u traffic from physical network port/s to the virtual port created in the previous step.</p> <p>NOTE: In the rule, 2152 is GTP-u traffic.</p>	<ol style="list-style-type: none"> 1. Select Maps > Maps > Maps. 2. Click New. 3. Configure the map. <ul style="list-style-type: none"> • Enter to_vp in the Alias field. • Select First Level for Type. • Select By Rule for Subtype. • Select the port 1/3/x9 for the Source. • Select the virtual port vp1 for the Destination. 4. Add a rule. <ol style="list-style-type: none"> a. Click Add a Rule. b. Select Pass. c. Select Ether Type d. Enter 8903 in the Value field. 5. Click Save.
6	<p>Create a first level map that directs GTP-u traffic from physical network port/s to the tool ports.</p> <p>NOTE: In the rule, 2123 is GTP-c traffic.</p>	<ol style="list-style-type: none"> 1. Select Maps > Maps > Maps. 2. Click New. 3. Configure the map. <ul style="list-style-type: none"> • Enter ctrl_to_tool in the Alias field. • Select Regular for Type. • Select By Rule for Subtype. • Select the port 1/3/x9 for the Source. • Select the port 1/3/x13 and port 1/3/x15 for the Destination.

Task	Description	UI Steps
		<ol style="list-style-type: none"> 4. Add a rule. <ol style="list-style-type: none"> a. Click Add a Rule. b. Select Pass. c. Select Port Source. d. Enter 2123 for the port value. 5. Click Save.
7	Create a second level map that takes traffic from the virtual port, applies the GigaSMART operation, and matches tunnel IDs specified by the gsrule.	<ol style="list-style-type: none"> 1. Select Maps > Maps > Maps. 2. Click New. 3. Configure the map. <ul style="list-style-type: none"> • Type m1 in the Alias field. • Select Second Level for Type. • Select By Rule for Subtype. • Select the port 1/3/x15 for the Source. • Select the virtual port vp1 for the Destination. • Select gsfil from the GSOP list. 4. Add a rule. <ol style="list-style-type: none"> a. Click Add a Rule. b. Select Pass. c. Select GTP-U TEID. d. Enter 0x001e8480 for Min and 0x001e8489 for Max. e. Set Subset to none. 6. Click Save.
8	Create a second level map that takes traffic from the virtual port, applies the GigaSMART operation, and matches tunnel IDs specified by the gsrule.	<ol style="list-style-type: none"> 1. Select Maps > Maps > Maps. 2. Click New. 3. Configure the map. <ul style="list-style-type: none"> • Type m2 in the Alias field. • Select Second Level for Type. • Select By Rule for Subtype. • Select the port 1/3/x15 for the Source. • Select the virtual port vp1 for the Destination. • Select gsfil from the GSOP list. 4. Add a rule. <ol style="list-style-type: none"> a. Click Add a Rule.

Task	Description	UI Steps
		<ol style="list-style-type: none"> b. Select Pass. c. Select GTP-U TEID. d. Enter 0x001e8490 for Min and 0x001e8499 for Max. e. Set Subset to none. <ol style="list-style-type: none"> 6. Click Save.
9	Add a shared collector for any unmatched data and send it to the third tool port.	<ol style="list-style-type: none"> 1. Select Maps > Maps > Maps. 2. Click New. 3. Configure the map. <ul style="list-style-type: none"> • Type scroll in the Alias field. • Select Second Level for Type. • Select Collector for Subtype. • Select the virtual port vp1 for the Source. • Select the port 1/3/x14 for the Destination. • Select gsfil from the GSOP list. 4. Click Save.

ERSPAN Tunneling

In this example, APF is used to filter packets based on ERSPAN ID. The ERSPAN header is not removed from the packet.

A second level map is configured in the example. A virtual port feeds traffic to the second level map. APF filters the packets and forwards those that match the filter criteria in the map.

Task	Description	UI Steps
1	Configure a tool type of port.	<ol style="list-style-type: none"> 1. Select Ports > Ports > All Ports. 2. Click Quick Port Editor. 3. Select Tool for a port. For example, port 1/1/g1. 4. Select Enable. 5. Click OK. 6. Close the Quick Port Editor.
2	Configure a GigaSMART group and associate it with a GigaSMART engine port.	<ol style="list-style-type: none"> 1. From the device view, select GigaSMART > GigaSMART Groups > GigaSMART Groups. 2. Click New.

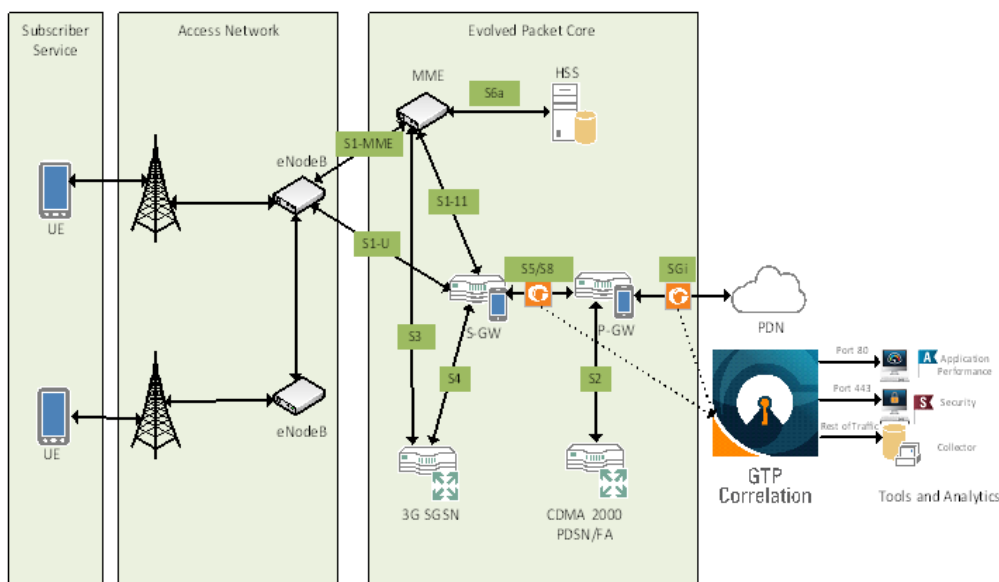
Task	Description	UI Steps
		<ol style="list-style-type: none"> 3. Type gsgp2 in the Alias field. 4. Select an engine port 1/3/e1 in the Port List field. For example, 1/3/e2 5. Click Save.
3	Create a virtual port and associate it with the GigaSMART group.	<ol style="list-style-type: none"> 1. From the device view, select GigaSMART > Virtual ports. 2. Click New. 3. Enter vp in the Alias field. 4. Select gsgrp2 from the GigaSMART Groups list. 5. Click Save.
4	Configure the GigaSMART operation and assign it to the GigaSMART group.	<ol style="list-style-type: none"> 1. From the device view, select GigaSMART > GigaSMART Operations (GSOP) > GigaSMART Operations. 2. Click New. 3. Type er2 in the Alias field. 4. Select gsgp2 from the GigaSMART Groups list. 5. Select Adaptive Packet Filtering from the GigaSMART Operations list. 6. Select Enable. 7. Click Save.
5	Create a first level map.	<ol style="list-style-type: none"> 1. Select Maps > Maps > Maps. 2. Click New. 3. Configure the map. <ul style="list-style-type: none"> • Type test1a in the Alias field. • Select First Level for Type. • Select By Rule for Subtype. • Select the network port for the Source. For example, 1/1/g3. • Select the virtual port vp for the Destination. • Select gsfil from the GSOP list. 4. Add a rule. <ol style="list-style-type: none"> a. Click Add a Rule. b. Select Pass. c. Select MAC Source d. Enter the address 0000.0000.0000 for Min and the address 0000.0000.0000 for Max. 5. Click Save.

Task	Description	UI Steps
6	Create a second level map.	<ol style="list-style-type: none"> 1. Select Maps > Maps > Maps. 2. Click New. 3. Configure the map. <ul style="list-style-type: none"> • Type test1b in the Alias field. • Select Second Level for Type. • Select By Rule for Subtype. • Select the network port for the Source. For example, 1/1/g3. • Select the virtual port vp for the Destination. • Select er2 from the GSOP list. 4. Add a rule. <ol style="list-style-type: none"> a. Click Add a Rule. b. Select Pass. c. Select MAC Source d. Enter the address 0000.0000.0000 for Min and the address 0000.0000.0000 for Max. 5. Click Save.

Distribute Traffic Based on Inner IP Addresses and Inner TCP Port Values

In the following example, traffic is distributed based on inner IP addresses and inner TCP port values as follows:

- Packets from VLAN 20 with GTP inner IP 65.128.7.21 and 98.43.132.70, inner TCP port 80 is forwarded to one tool port
- Packets from VLAN 20 with GTP inner IP 65.128.7.21 and 98.43.132.70, inner TCP port 443 is forwarded to a second tool port
- All packets not matching these rules is forwarded to a third tool port



Task	Description	UI Steps
1	Configure one network and three tool type of ports.	<ol style="list-style-type: none"> 1. Select Ports > Ports > All Ports. 2. Click Quick Port Editor. 3. Configure one network port and three tool ports. For example, select Network for port 1/1/x1. Select Tool for the ports 1/1/x10, 1/1/x11, and 1/1/x12. 4. Select Enable for each port. 5. Click OK. 6. Close the Quick Port Editor.
2	Configure a GigaSMART group and associate it with a GigaSMART engine port.	<ol style="list-style-type: none"> 1. From the device view, select GigaSMART > GigaSMART Groups > GigaSMART Groups. 2. Click New. 3. Type gsgrp1 in the Alias field. 4. Select an engine port in the Port List field. For example, 1/1/e1. 5. Click Save.
3	Configure the GigaSMART operation and assign it to the GigaSMART group. Packets processed by this operation are evaluated using Adaptive Packet Filtering (APF) rules.	<ol style="list-style-type: none"> 1. From the device view, select GigaSMART > GigaSMART Operations (GSOP) > GigaSMART Operation. 2. Click New. 3. Type g1 in the Alias field. 4. Select gsgrp1 from the GigaSMART Groups list. 5. Select APF from the GigaSMART Operations (GSOP) list. 6. Select Enable. 7. Click Save.
4	Configure a virtual port and associate it	<ol style="list-style-type: none"> 1. From the device view, select GigaSMART > Virtual ports.

Task	Description	UI Steps
	with the GigaSMART group.	<ol style="list-style-type: none"> 2. Click New. 3. Enter gsTraffic in the Alias field. 4. Select gsgp1 from the GigaSMART Groups list. 5. Click Save.
5	Create a first level map that directs traffic from the physical network port to the virtual port created in the previous step.	<ol style="list-style-type: none"> 1. Select Maps > Maps > Maps. 2. Click New. 3. Configure the map. <ul style="list-style-type: none"> • Type map1 in the Alias field. • Select First Level for Type. • Select By Rule for Subtype. • Select the network port for the Source. For example, 1/1/x1 • Select the virtual port gsTraffic for the Destination. 4. Add a rule with three conditions. <ol style="list-style-type: none"> a. Click Add a Rule. b. Select Pass. c. Select VLAN and enter 20 for Min. d. Select IPv4 Protocol and select UDP for Value. e. Select Port Destination and enter 2152 for the port value 6. Click Save.
6	Create a second level map that takes traffic from the virtual port, applies the GigaSMART operation, matches the rules, and sends the traffic to one tool port.	<ol style="list-style-type: none"> 1. Select Maps > Maps > Maps. 2. Click New. 3. Configure the map. <ul style="list-style-type: none"> • Type map2 in the Alias field. • Select Second Level for Type. • Select By Rule for Subtype. • Select the virtual port gsTraffic for the Source. • Select the port 1/1/x10 for the Destination. • Select g1 from the GSOP list. 4. Add a rule with three conditions. <ol style="list-style-type: none"> a. Click Add a Rule. b. Select Pass.

Task	Description	UI Steps
		<ul style="list-style-type: none"> c. Select IPv4 Destination then enter 65.128.721 for the IP address and 255.255.255.255 for the Net Mask. Set position to 2. d. Select IPv4 Protocol and set the Position to 2. e. Select Port Destination and enter 80 for the port value and select 2 for Position. <p>6. Add a rule with three conditions.</p> <ul style="list-style-type: none"> a. Click Add a Rule. b. Select Pass. c. Select IPv4 Destination then enter 98.43.132.70 for the IP address and 255.255.255.255 for the Net Mask. Set Position to 2. d. Select IPv4 Protocol and set the Position to 2. e. Select Port Destination and enter 80 for the port value and select 2 for Position. <p>6. Click Save.</p>
7	Create a second level map that takes traffic from the virtual port, applies the GigaSMART operation, matches the rules, and sends the traffic to another tool port.	<ul style="list-style-type: none"> 1. Select Maps > Maps > Maps. 2. Click New. 3. Configure the map. <ul style="list-style-type: none"> • Type map3 in the Alias field. • Select Second Level for Type. • Select By Rule for Subtype. • Select the virtual port gsTraffic for the Source. • Select the port 1/1/x10 for the Destination. • Select g1 from the GSOP list. 4. Add a rule with three rule conditions. <ul style="list-style-type: none"> a. Click Add a Rule. b. Select Pass. c. Select IPv4 Destination then enter 65.128.721 for the IP address and 255.255.255.255 for the Net Mask. Set Position to 2. d. Select IPv4 Protocol. Set Position to 2 e. Select Port Destination and enter 443 for the port value and select 2 for Position. 6. Add another rule with three rule conditions. <ul style="list-style-type: none"> a. Click Add a Rule. b. Select Pass.

Task	Description	UI Steps
		<ul style="list-style-type: none"> c. Select IPv4 Destination then enter 98.43.132.70 for the IP address and 255.255.255.255 for the Net Mask. Set position to 2. d. Select IPv4 Protocol. Set position to 2. e. Select Port Destination and enter 443 for the port value and set Position to 2. <p>6. Click Save.</p>
8	Add a shared collector for any unmatched data and send it to the third tool port.	<ul style="list-style-type: none"> 1. Select Maps > Maps > Maps. 2. Click New. 3. Configure the map. <ul style="list-style-type: none"> • Type mapclin in the Alias field. • Select Second Level for Type. • Select Collector for Subtype. • Select the virtual port gsTraffic for the Source. • Select the port 1/1/x12 for the Destination. 4. Click Save.

MPLS Label Based Filtering

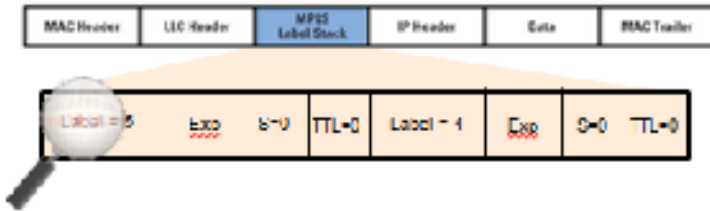
Multiprotocol Label Switching (MPLS) is a mechanism in high-performance telecommunications networks that directs data from one network node to the next based on short path labels rather than long network addresses, avoiding complex lookups in a routing table. The labels identify virtual links (paths) between distant nodes rather than endpoints.

MPLS is a scalable, protocol-independent transport. In an MPLS network, data packets are assigned labels. Packet-forwarding decisions are made solely on the contents of this label, without the need to examine the packet itself. This allows one to create end-to-end circuits across any type of transport medium, using any protocol.

However in the context of Visibility Platform nodes, traffic flows encapsulated in MPLS labels cannot be filtered and forwarded. With the wide-scale adoption of MPLS as a technology across enterprise and service provider environments, the ability to classify traffic flows based on MPLS labels would be a huge value add to granularly control the flow of traffic to the monitoring tools. APF can be leveraged to filter and forward traffic flows based on MPLS label values. MPLS can stack multiple labels to form tunnels within tunnels. The flexibility of APF facilitates traffic classifications across up

to 5 levels of MPLS label stacks in addition to the capability to filter and forward based on Layer 2-4 parameters found in the encapsulated packet. The following example illustrates filtering and forwarding traffic based on MPLS labels, as follows:

- Filter and forward traffic flows specific to mpls label = 4 at the second level in the MPLS label stack to tool 1
- Filter and forward traffic flows specific to mpls label = 3 at the first level in the MPLS label stack to tool 2



Step	Description	Command
1	Configure ports.	<ol style="list-style-type: none"> 1. Select Ports > Ports > All Ports. 2. Click Quick Port Editor. 3. Configure one network port and two tool ports. For example, select Network for port 1/1/x3 and select Tool for the ports 1/1/x4 and 1/1/x1 4. Select Enable for each port. 5. Click OK. 6. Close the Quick Port Editor.
2	Configure a GigaSMART group and associate it with a GigaSMART engine port.	<ol style="list-style-type: none"> 1. From the device view, select GigaSMART > GigaSMART Groups > GigaSMART Groups. 2. Click New. 3. Type gsg1 in the Alias field. 4. Select an engine port in the Port List field. For example, 1/1/e1 5. Click Save.
3	Configure the GigaSMART operation.	<ol style="list-style-type: none"> 1. From the device view, select GigaSMART > GigaSMART Operations (GSOP) > Operations. 2. Click New. 3. Type gsfil in the Alias field. 4. Select gsg1 from the GigaSMART Groups list. 5. Select APF from the GigaSMART Operations list. 6. Select Enable. 7. Click Save.

Step	Description	Command
4	Create a virtual port and associate it with the GigaSMART group.	<ol style="list-style-type: none"> 1. From the device view, select GigaSMART > Virtual ports. 2. Click New. 3. Enter vp1 in the Alias field. 4. Select gsg1 from the GigaSMART Groups list. 5. Click Save.
5	Create a first level map to forward traffic to the virtual port.	<ol style="list-style-type: none"> 1. Select Maps > Maps > Maps. 2. Click New. 3. Configure the map. <ul style="list-style-type: none"> • Type to_vp in the Alias field. • Select First Level for Type. • Select By Rule for Subtype. • Select the network port for the Source. For example, 1/1/x3 • Select the virtual port vp1 for the Destination. 4. Add Rule 1. <ol style="list-style-type: none"> a. Click Add a Rule. b. Select Pass. c. Select IP Version and set Version to v4. 4. Add Rule 2. <ol style="list-style-type: none"> a. Click Add a Rule. b. Select Pass and Bi Directional. c. Select MAC Source and enter 00:00:00:00:00:00 for the address. d. Set Version to v4. 5. Click Save.
6	Create another second level map to filter on MPLS label.	<ol style="list-style-type: none"> 1. Select Maps > Maps > Maps. 2. Click New. 3. Configure the map. <ul style="list-style-type: none"> • Type map1 in the Alias field. • Select Second Level for Type. • Select By Rule for Subtype. • Select the virtual port vp1 for the Source. • Select the port 1/1/x1 for the Destination. • Select gsfil from the GSOP list.

Step	Description	Command
		<ol style="list-style-type: none"> 4. Add a rule. <ol style="list-style-type: none"> a. Click Add a Rule. b. Select Pass. c. Select MPLS Label. d. Set the value to 4 and the Position to 1 5. Click Save.
7	Create another second level map to filter on MPLS label.	<ol style="list-style-type: none"> 1. Select Maps > Maps > Maps. 2. Click New. 3. Configure the map. <ul style="list-style-type: none"> • Type map2 in the Alias field. • Select Second Level for Type. • Select By Rule for Subtype. • Select the virtual port vp1 for the Source. • Select the port 1/1/x4 for the Destination. • Select gsfil from the GSOP list. 4. Add a rule. <ol style="list-style-type: none"> a. Click Add a Rule. b. Select Pass. c. Select MPLS Label. d. Set the value to 3 and the Position to 1 5. Click Save.

Combine APF with GigaSMART Operations

APF can also be combined with other GigaSMART functions including Header Stripping, Packet Slicing or Masking, De-Duplication and FlowVUE. This provides network administrators and operators to perform a second layer of filtering in combination with the GigaSMART tool optimization and packet manipulation operations.

In the following example, operators can distribute traffic to monitoring tools based on decapsulated contents, more specifically, after Header stripping VXLAN:

- Identifying and forwarding traffic from/to ip 1.1.1.1 from the decapsulated packets to monitoring tool connected to tool port 1/1/x1
- Identifying and forwarding traffic from/to ip 1.1.1.2 in the decapsulated packets to monitoring tool connected to tool port 1/1/x4

NOTE: This can be applied to any protocol that is supported through header-stripping, for example:

- GTP, VXLAN, ISL, MPLS, MPLS+VLAN, VLAN, VN-Tag, fabric-path.
- This is also supported for Gigamon tunnel decapsulation.

Step	Description	Command
1	Configure ports.	<ol style="list-style-type: none"> 1. Select Ports > Ports > All Ports. 2. Click Quick Port Editor. 3. Configure one network port and two tool ports. For example, select Network for port 1/1/x3 and select Tool for the ports 1/1/x4 and 1/1/x1 4. Select Enable for each port. 5. Click OK. 6. Close the Quick Port Editor.
2	Configure a GigaSMART group and associate it with a GigaSMART engine port.	<ol style="list-style-type: none"> 1. From the device view, select GigaSMART > GigaSMART Groups > GigaSMART Groups. 2. Click New. 3. Type gsg1 in the Alias field. 4. Select an engine port in the Port List field. For example, 1/1/e1 5. Click Save.
3	Configure the GigaSMART operation.	<ol style="list-style-type: none"> 1. From the device view, select GigaSMART > GigaSMART Operations (GSOP) > GigaSMART Operations. 2. Click New. 3. Type gsfil_vxlanhs in the Alias field. 4. Select gsg1 from the GS Groups list. 5. Select Adaptive Packet Filtering from the GigaSMART Operations (GSOP) list and Enable. 6. Select Strip Header from the GigaSMART Operations (GSOP) list and select VXLAN. 7. Click Save.
4	Create a virtual port and associate it with the GigaSMART group.	<ol style="list-style-type: none"> 1. From the device view, select GigaSMART > Virtual ports. 2. Click New. 3. Enter vp1 in the Alias field. 4. Select gsg1 from the GigaSMART Groups list. 5. Click Save.
5	Create a first level map to forward VXLAN traffic to the virtual port.	<ol style="list-style-type: none"> 1. Select Maps > Maps > Maps. 2. Click New.

Step	Description	Command
	VXLAN accepts destination UDP ports 8472 and 4789. Starting in software version 4.5.01, VXLAN also accepts destination UDP port 48879.	<ol style="list-style-type: none"> 3. Configure the map. <ul style="list-style-type: none"> • Type to_vp in the Alias field. • Select First Level for Type. • Select By Rule for Subtype. • Select the network port for the Source. For example, 1/1/x3 • Select the virtual port vp1 for the Destination. 4. Add a rule. <ol style="list-style-type: none"> a. Click Add a Rule. b. Select Pass. c. Select Port Source and set the port value to 8472. 4. Click Save.
6	Create a second level map to filter on source and destination IP (bi-directional).	<ol style="list-style-type: none"> 1. Select Maps > Maps > Maps. 2. Click New. 3. Configure the map. <ul style="list-style-type: none"> • Enter map1 in the Alias field. • Select Second Level for Type. • Select By Rule for Subtype. • Select the virtual port vp1 for the Source. • Select the tool port 1/1/x1 for the Destination. • Select gsfil from the GSOP list. 4. Add Rule 1. <ol style="list-style-type: none"> a. Click Add a Rule. b. Select Pass. c. Select IPv4 Source. d. Enter 1.1.1.1 for the IPv4 Address e. Enter 255.255.255.255 for the Net Mask f. Set Position to 2. 7. Add a Rule 2. <ol style="list-style-type: none"> a. Click Add a Rule. b. Select Pass. c. Select IPv4 Destination. d. Enter 1.1.1.1 for the IPv4 Address e. Enter 255.255.255.255 for the Net Mask

Step	Description	Command
		<ol style="list-style-type: none"> <li data-bbox="792 289 1015 317">f. Set Position to 2. <li data-bbox="743 331 902 359">7. Click Save.
8	Create another second level map to filter on source and destination IP (bi-directional).	<ol style="list-style-type: none"> <li data-bbox="743 390 1094 417">1. Select Maps > Maps > Maps. <li data-bbox="743 432 902 459">2. Click New. <li data-bbox="743 474 992 501">3. Configure the map. <ul style="list-style-type: none"> <li data-bbox="803 516 1195 543">• Enter map1 in the Alias field. <li data-bbox="803 569 1208 596">• Select Second Level for Type. <li data-bbox="803 621 1175 648">• Select By Rule for Subtype. <li data-bbox="803 674 1360 701">• Select the virtual port vp1 for the Source. <li data-bbox="803 726 1430 753">• Select the tool port 1/1/x1 for the Destination. <li data-bbox="803 779 1224 806">• Select gsfil from the GSOP list. <li data-bbox="743 831 911 858">4. Add Rule 1. <ol style="list-style-type: none"> <li data-bbox="792 873 1015 900">a. Click Add a Rule. <li data-bbox="792 915 959 942">b. Select Pass. <li data-bbox="792 957 1036 984">c. Select IPv4 Source. <li data-bbox="792 999 1182 1026">d. Enter 1.1.1.2 for the IPv4 Address <li data-bbox="792 1041 1243 1068">e. Enter 255.255.255.255 for the Net Mask <li data-bbox="792 1083 1015 1110">f. Set Position to 2. <li data-bbox="743 1125 932 1152">7. Add a Rule 2. <ol style="list-style-type: none"> <li data-bbox="792 1167 1015 1194">a. Click Add a Rule. <li data-bbox="792 1209 959 1236">b. Select Pass. <li data-bbox="792 1251 1081 1278">c. Select IPv4 Destination. <li data-bbox="792 1293 1182 1320">d. Enter 1.1.1.2 for the IPv4 Address <li data-bbox="792 1335 1243 1362">e. Enter 255.255.255.255 for the Net Mask <li data-bbox="792 1377 1015 1404">f. Set Position to 2. <li data-bbox="743 1419 902 1446">7. Click Save.

Conditional Header Stripping

Another use-case that can be addressed leveraging the flexibility of APF would be the capability to header strip packets based on specific contents found across the packet including the inner packet contents. Since the APF rules are enforced before any other GigaSMART operation, operators can filter based on encapsulation protocol values and /or encapsulated (original) packet contents and apply conditional header stripping operations.

The following example shows how an end-user can filter and strip out outer VXLAN headers for a subset of the traffic based on inner IP addresses, while sending the rest of the traffic "as-is" to monitoring tools that need the VXLAN headers for traffic analysis, as follows.

- Identifying and forwarding traffic from/to ip 1.1.1.1 in the inner / encapsulated packets to monitoring tool connected to tool port 1/1/x1 *after* header stripping VXLAN.
- Identifying and forwarding traffic from/to ip 1.1.1.2 in the inner / encapsulated packets to monitoring tool connected to tool port 1/1/x4 *without* stripping the VXLAN header.

NOTE: This can be applied to any GigaSMART operation. While this example shows filtering based on inner packet contents, conditional SMART operations can be applied by filtering on encapsulation headers as well.

VXLAN Encapsulation

Outer MAC DA	Outer MAC SA	Outer 802.1Q	Outer IP DA	Outer IP SA	Outer UDP	VXLAN ID(24 Bit)	Inner MAC DA	Inner MAC SA	Optional Inner 802.1q	Original Ethernet Payload
--------------------	--------------------	-----------------	----------------	----------------	--------------	------------------------	--------------------	--------------------	-----------------------------	---------------------------------

NOTE: This can be applied to any protocol that is supported through header stripping. GTP, VXLAN, ISL, MPLS, MPLS+VLAN, VLAN, VN-Tag, and fabric-path are all supported, as is Gigamon tunnel decapsulation.

Step	Description	Command
1	Configure ports.	<ol style="list-style-type: none"> 1. Select Ports > Ports > All Ports. 2. Click Quick Port Editor. 3. Configure one network port and two tool ports. For example, select Network for port 1/1/x3 and select Tool for the ports 1/1/x4 and 1/1/x1 4. Select Enable for each port. 5. Click OK. 6. Close the Quick Port Editor.
2	Configure a GigaSMART group and associate it with a GigaSMART engine port.	<ol style="list-style-type: none"> 1. From the device view, select GigaSMART > GigaSMART Groups (GSOP) > GigaSMART Groups. 2. Click New. 3. Type gsg1 in the Alias field. 4. Select an engine port in the Port List field. For example, 1/1/e1. 5. Click Save.

Step	Description	Command
3	Configure the GigaSMART operations.	<ol style="list-style-type: none"> 1. From the device view, select GigaSMART > GigaSMART Operations (GSOP) > GigaSMART Operations and create two GigaSMART Operations. 2. Create the first operation. <ol style="list-style-type: none"> a. Click New. b. Type gsil_vxlanhs in the Alias field. c. Select gsg1 from the GigaSMART Groups list. d. Select Adaptive Packet Filtering from the GigaSMART Operations list and Enable. e. Select Strip Header from the GigaSMART Operations list and select VXLAN. f. Click Save. 7. Create second first operation. <ol style="list-style-type: none"> a. Click New. b. Type gsil_apf in the Alias field. c. Select gsg1 from the GigaSMART Groups list. d. Select Adaptive Packet Filtering from the GS Operations (GSOP) list and Enable. e. Click Save.
4	Create a virtual port and associate it with the GigaSMART group.	<ol style="list-style-type: none"> 1. From the device view, select GigaSMART > Virtual ports. 2. Click New. 3. Enter vp1 in the Alias field. 4. Select gsg1 from the GigaSMART Groups list. 5. Click Save.
5	Create a first level map to forward VXLAN traffic to the virtual port.	<ol style="list-style-type: none"> 1. Select Maps > Maps > Maps. 2. Click New. 3. Configure the map. <ul style="list-style-type: none"> • Type to_vp in the Alias field. • Select First Level for Type. • Select By Rule for Subtype. • Select the network port for the Source. For example, 1/1/x3 • Select the virtual port vp1 for the Destination. 4. Add a rule. <ol style="list-style-type: none"> a. Click Add a Rule. b. Select Pass. c. Select Port Source and set the port value to 8472.

Step	Description	Command
		<ol style="list-style-type: none"> 4. Click Save.
6	Create a second level map to filter on source and destination IP (bi-directional), using first GigaSMART operation.	<ol style="list-style-type: none"> 1. Select Maps > Maps > Maps. 2. Click New. 3. Configure the map. <ul style="list-style-type: none"> • Enter map1 in the Alias field. • Select Second Level for Type. • Select By Rule for Subtype. • Select the virtual port vp1 for the Source. • Select the tool port 1/1/x1 for the Destination. • Select <code>gsfil_vxlanhs</code> from the GSOP list. 4. Add Rule 1. <ol style="list-style-type: none"> a. Click Add a Rule. b. Select Pass. c. Select IPv4 Source. d. Enter 1.1.1.1 for the IPv4 Address e. Enter 255.255.255.255 for the Net Mask f. Set Position to 2. 7. Add a Rule 2. <ol style="list-style-type: none"> a. Click Add a Rule. b. Select Pass. c. Select IPv4 Destination. d. Enter 1.1.1.1 for the IPv4 Address e. Enter 255.255.255.255 for the Net Mask f. Set Position to 2. 7. Click Save.
7	Create another second level map to filter on source and destination IP (bi-directional), using second GigaSMART operation.	<ol style="list-style-type: none"> 1. Select Maps > Maps > Maps. 2. Click New. 3. Configure the map. <ul style="list-style-type: none"> • Enter map1 in the Alias field. • Select Second Level for Type. • Select By Rule for Subtype. • Select the virtual port vp1 for the Source. • Select the tool port 1/1/x4 for the Destination.

Step	Description	Command
		<ul style="list-style-type: none"> Select gsfil from the GSOP list. <ol style="list-style-type: none"> Add Rule 1. <ol style="list-style-type: none"> Click Add a Rule. Select Pass. Select IPv4 Source. Enter 1.1.1.2 for the IPv4 Address Enter 255.255.255.255 for the Net Mask Set Position to 2. Add a Rule 2. <ol style="list-style-type: none"> Click Add a Rule. Select Pass. Select IPv4 Destination. Enter 1.1.1.2 for the IPv4 Address Enter 255.255.255.255 for the Net Mask Set Position to 2. Click Save.

Facilitate Overlapping Rules

Because APF is implemented as a second level map operation, APF can also be leveraged for implementing basic overlapping rules. For the same incoming input stream, a copy of the traffic can be sent out to a group of monitoring tools while a refined subset of the traffic stream can be sent to a different set of monitoring tools. Typically overlapping rules would be implemented by combining APF with the patented Flow Mapping® technology.

Note that Role-Based Access control in the case of APF is applied at the gsgroup / e port.

In the following example, for the same input stream:

- HTTP traffic is identified and distributed to a monitoring tool connected to tool port 1/1/x1.
- At the same time, the same stream of HTTP packets are being sent out after slicing unwanted packet contents to a different monitoring tool connected to tool port 1/1/x4.

Step	Description	Command
1	Configure ports.	1. Select Ports > Ports > All Ports.

Step	Description	Command
		<ol style="list-style-type: none"> 2. Click Quick Port Editor. 3. Configure one network port and two tool ports. For example, select Network for port 1/1/x3 and select Tool for the ports 1/1/x4 and 1/1/x1 4. Select Enable for each port. 5. Click OK. 6. Close the Quick Port Editor.
2	Configure a GigaSMART group and associate it with a GigaSMART engine port.	<ol style="list-style-type: none"> 1. From the device view, select GigaSMART > GigaSMART Groups > GigaSMART Groups. 2. Click New. 3. Type gsg1 in the Alias field. 4. Select an engine port in the Port List field. For example, 1/1/e1. 5. Click Save.
3	Configure the GigaSMART operations.	<ol style="list-style-type: none"> 1. From the device view, select GigaSMART > GigaSMART Operations (GSOPS) > Operations and create two GigaSMART Operations. 2. Create the first operation. <ol style="list-style-type: none"> a. Click New. b. Type gsfil in the Alias field. c. Select gsg1 from the GigaSMART Groups list. d. Select APF from the GigaSMART Operations list and Enable. e. Click Save. 6. Create second operation. <ol style="list-style-type: none"> a. Click New. b. Type gsfil_slice in the Alias field. c. Select gsg1 from the GigaSMART Groups list. d. Select APF from the GigaSMART Operations (GSOP) list and Enable. e. Select Slicing from the GigaSMART Operations (GSOP) list and select None. Set Offset to 150. 6. Click Save.
4	Create a virtual port and associate it with the GigaSMART group.	<ol style="list-style-type: none"> 1. From the device view, select GigaSMART > Virtual ports. 2. Click New. 3. Enter vp1 in the Alias field. 4. Select gsg1 from the GigaSMART Groups list. 5. Click Save.
5	Create a first level map to forward traffic	<ol style="list-style-type: none"> 1. Select Maps > Maps > Maps.

Step	Description	Command
	to the virtual port. Port 1/1/x1 and virtual port vp1 are sent destination port 80 traffic, which is HTTP.	<ol style="list-style-type: none"> 2. Click New. 3. Configure the map. <ul style="list-style-type: none"> • Type to_vp in the Alias field. • Select First Level for Type. • Select By Rule for Subtype. • Select the network port 1/1/x3 for the Source. • Select the virtual port vp1 and the tool port 1/1/x1 for the Destination. 4. Add a rule. <ol style="list-style-type: none"> a. Click Add a Rule. b. Select Pass. c. Select Port Source and set the port value to 2152. 4. Click Save.
6	Create a second level map to filter on HTTP traffic and slice it.	<ol style="list-style-type: none"> 1. Click New. 2. Configure the map. <ul style="list-style-type: none"> • Type map1 in the Alias field. • Select Second Level for Type. • Select By Rule for Subtype. • Select the virtual port vp1 for the Source. • Select the virtual tool port 1/1/x4 for the Destination. • Select gsfil_slice from the GSOP list. 3. Add Rule 1. <ol style="list-style-type: none"> a. Click Add a Rule. b. Select Pass. c. Select IP Version d. Set Version to v4 e. Set Position to 1 6. Click Save.
7	Create another second level map for the rest of the traffic.	<ol style="list-style-type: none"> 1. Click New. 2. Configure the map. <ul style="list-style-type: none"> • Type map2 in the Alias field. • Select First Level for Type. • Select By Rule for Subtype.

Step	Description	Command
		<ul style="list-style-type: none"> • Select the virtual port vp1 for the Source. • Select the virtual port 1/1/x1 for the Destination. • Select gsfil from the GSOP list. <ol style="list-style-type: none"> 3. Add a rule. <ol style="list-style-type: none"> a. Click Add a Rule. b. Select Pass. c. Select IP Version. d. Set Version to v4. e. Set Postilion to 4 6. Click Save.

In the following example, for the same traffic stream, TCP traffic is sent to one monitoring tool while forwarding a subset of TCP flows specific to HTTP to another monitoring tool connected to tool port 1/1/x4.

Step	Description	Command
1	Configure ports.	<ol style="list-style-type: none"> 1. Select Ports > Ports > All Ports. 2. Click Quick Port Editor. 3. Configure one network port and two tool ports. For example, select Network for port 1/1/x3 and select Tool for the port s 1/1/x4 and 1/1/x1 4. Select Enable for each port. 5. Click OK. 6. Close the Quick Port Editor.
2	Configure a GigaSMART group and associate it with a GigaSMART engine port.	<ol style="list-style-type: none"> 1. From the device view, select GigaSMART > GigaSMART Groups > GigaSMART Groups. 2. Click New. 3. Type gsg1 in the Alias field. 4. Select an engine port in the Port List field. For example, 1/1/e1. 5. Click Save.
3	Configure the GigaSMART operations.	<ol style="list-style-type: none"> 1. From the device view, select GigaSMART > GigaSMART Operations (GSOPS) > GigaSMART Operation and create two GigaSMART Operations. 2. Click New. 3. Type gsfil in the Alias field.

Step	Description	Command
		<ol style="list-style-type: none"> 4. Select gsg1 from the GS Groups list. 5. Select Adaptive Packet Filtering from the GS Operations list and Enable. 6. Click Save.
4	Create a virtual port and associate it with the GigaSMART group.	<ol style="list-style-type: none"> 1. From the device view, select GigaSMART > Virtual ports. 2. Click New. 3. Enter vp1 in the Alias field. 4. Select gsg1 from the GigaSMART Groups list. 5. Click Save.
5	Create a first level map to forward TCP traffic to the virtual port.	<ol style="list-style-type: none"> 1. Select Maps > Maps > Maps. 2. Click New. 3. Configure the map. <ul style="list-style-type: none"> • Type to_vp in the Alias field. • Select First Level for Type. • Select By Rule for Subtype. • Select the network port 1/1/x3 for the Source. • Select the virtual port vp1 and the tool port 1/1/x4 for the Destination. 4. Add a rule. <ol style="list-style-type: none"> a. Click Add a Rule. b. Select Pass. c. Select IPv4 Protocol and set the value to TCP. 4. Click Save.
6	Create a second level map to filter on HTTP traffic.	<ol style="list-style-type: none"> 1. Click New. 2. Configure the map. <ul style="list-style-type: none"> • Type map1 in the Alias field. • Select Second Level for Type. • Select By Rule for Subtype. • Select the virtual port vp1 for the Source. • Select the virtual tool port 1/1/x1 for the Destination. • Select gsfil form the GSOP list. 3. Add Rule 1.

Step	Description	Command
		<ol style="list-style-type: none"> a. Click Add a Rule. b. Select Pass. c. Select IPv4 Destination. d. Set Position to 2 e. Set the port value to 80. <ol style="list-style-type: none"> 6. Add Rule 2. <ol style="list-style-type: none"> a. Click Add a Rule. b. Select Pass. c. Select IPv4 Source. d. Set Position to 2 e. Set the port value to 80. 6. Click Save.

Display APF Statistics

Refer to [APF Statistics Definitions](#) for descriptions of these statistics as well as to [GigaSMART Operations Statistics Definitions](#).

GigaSMART Load Balancing

GigaSMART Enhanced Load Balancing require a separate license.

Stateless Load Balancing is included with Base licenses.

Stateful Load Balancing for GTP is included with the GTP Filtering & Correlation license.

Stateful Load Balancing for ASF is included with the Application Session Filtering (ASF) license.

Stateful Load Balancing for tunnel is included with the Advanced Tunneling license (GigaVUE-HC2, and GigaVUE-HC3), and Tunneling license (GigaVUE-HC1)

Load balancing distributes GigaSMART outgoing traffic to multiple tool ports or multiple tunnel endpoint destinations. In this way, traffic processed by GigaSMART is shared.

Stateful load balancing distributes GigaSMART processed traffic to multiple tool ports or tunnel endpoints based on GigaSMART application-specific flow sessions. Stateless load balancing distributes GigaSMART processed traffic to multiple tool ports or tunnel endpoints based on hash values generated from predefined protocol fields in the packet.

Load balancing operations to tool ports can be assigned to GigaSMART groups consisting of multiple engine ports. Refer to [Groups of GigaSMART Engine Ports](#) for details.

The following sections describe the available load balancing schemes:

- [Stateful Load Balancing](#)

- [Stateless Load Balancing](#)
- [Enhanced Load Balancing](#)

Stateful Load Balancing

Stateful load balancing distributes GigaSMART processed traffic to multiple tool ports or tunnel endpoints based on GigaSMART application-specific flow sessions.

With stateful load balancing, packets belonging to the same flow session maintained by GigaSMART applications are forwarded to the same tool port or tunnel endpoint within a port group.

Use the **GigaSMART Operations (GSOP)** page to configure load balancing. Specify one stateful application within a group of GigaSMART operations and specify a load balancing metric.

GTP, Application Session Filtering (ASF), and tunnel are the currently supported stateful applications.

For information on GTP, refer to [GigaSMART GTP Correlation](#).

For information on ASF, refer to [GigaSMART Application Session Filtering \(ASF\) and Buffer ASF](#).

For information on Layer 2 GRE tunnel encapsulation, refer to [GigaSMART Layer 2 GRE Tunnel Encapsulation/Decapsulation](#).

For details on stateful load balancing, refer to the following sections:

- [Stateful Load Balancing Metrics](#)
- [Hashing Key Support](#)
- [Configure Stateful Load Balancing](#)

To select stateful load balancing, do the following:

1. From the device view, select **GigaSMART > GigaSMART Operations (GSOP)**, and then click **New**.
2. Specify an alias in the **Alias** field.
3. Click in the **GigaSMART Group** field and select a GigaSMART Group.
4. Click in the **GigaSMART Operations (GSOP)** field and select **Load Balancing** from the drop-down list.
5. Select **Stateful**.
6. For **Type**, select one stateful application within a group of GigaSMART operations.
GTP, ASF, and Tunnel are the currently supported stateful applications.

- Specify a load balancing metric. For example, **Hashing** as shown in [Figure 398: Configuring Stateful Load Balancing](#).

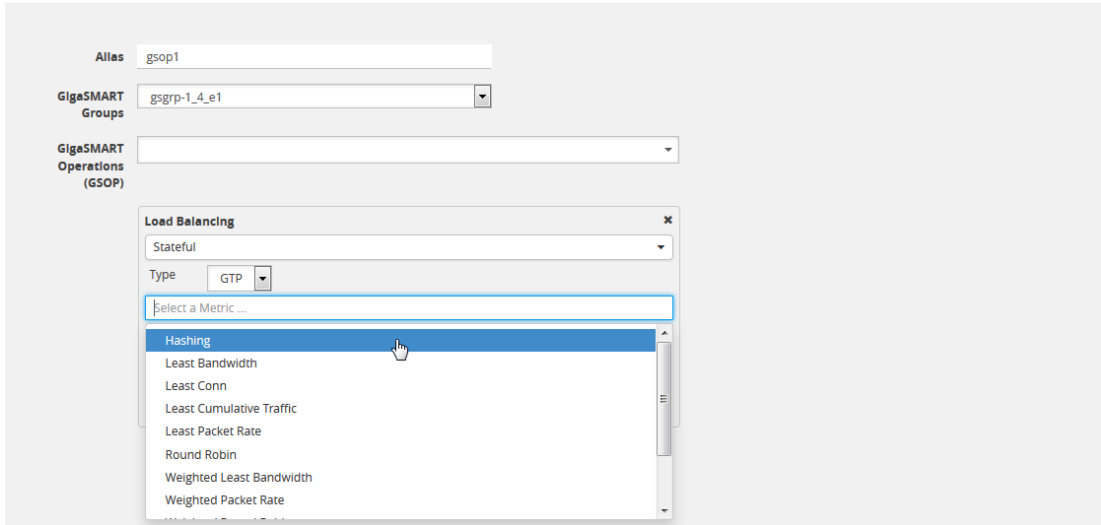


Figure 398: Configuring Stateful Load Balancing

Stateful Load Balancing Metrics

The load balancing metrics available for stateful load balancing are described in the following table.

For weighted metrics, such as Weighted Least Bandwidth, you can either define a weight for each port such as 5,10, 25, 50, or you can use link speed: 1 for 1Gb, 10 for 10Gb, 40 for 40Gb, 100 for 100Gb. Use the **Port Groups** configuration page to select weight and use the **Port** configuration page to select link speed.

NOTE: Only the traffic from the stateful application (for example, GTP, ASF, or tunnel) is used to perform load balancing. Other traffic in the map that does not match the application's filter rule is excluded.

Metric	Description
Least Bandwidth	A tool port is selected from a port group based on the least bits per second load to the port. To compensate for bursty traffic, the history of the last 10 second bandwidth is considered on the load balancing decision. This metric is not supported for tunnel.
Weighted Least Bandwidth	A tool port is selected from a port group based on the least bits per second load to the port, as described under Least Bandwidth. This metric is not supported for tunnel. If the following command is enabled, link speed is considered in addition to the bandwidth of the port. If the following command is disabled, the weight configured

Metric	Description
	for each port in the port group is considered in addition to the bandwidth of the port.
Least Packet Rate	<p>A tool port is selected from a port group based on Least Packet Rate.</p> <p>To compensate for bursty traffic, the history of the last 10 second packet count is considered on the load balancing decision.</p>
Weighted Least Packet Rate	<p>A tool port is selected from a port group based on Least Packet Rate, as described under Least Packet Rate.</p> <p>With Weighted Least Packet Rate, if a port has a higher weight, it will be sent more traffic.</p> <p>If the following command is enabled, link speed is considered with packet rate. If the following command is disabled, the weight configured for each port in the port group is considered with packet rate.</p>
Round Robin	A tool port is selected from a port group based on round robin.
Weighted Round Robin	<p>A tool port is selected from a port group based on least packet rate, as described under Round Robin.</p> <p>If the following command is enabled, link speed is considered with Round Robin. If the following command is disabled, the weight configured for each port in the port group is considered with Round Robin.</p>
Least Connection	<p>A tool port is selected from a port group based on the current Least Connection assigned to each tool port. The port with the least number of connections assigned is selected.</p> <div data-bbox="553 1045 1453 1115" style="border: 1px solid black; padding: 5px;"> <p>NOTE: The meaning of connection is defined by the application.</p> </div>
Weighted Least Connection	<p>A tool port is selected from a port group based on the current Least Connection assigned to each tool port, as described under Least Connection.</p> <p>If the following command is enabled, link speed is considered with Least Connection. If the following command is disabled, the weight configured for each port in the port group is considered with Least Connection.</p> <div data-bbox="553 1318 1453 1388" style="border: 1px solid black; padding: 5px;"> <p>NOTE: The meaning of connection is defined by the application.</p> </div>
Least Cumulative Traffic	<p>A tool port is selected from a port group based on the least total bytes sent to each tool port. The port with the least number of connections assigned is selected.</p> <div data-bbox="553 1486 1453 1556" style="border: 1px solid black; padding: 5px;"> <p>NOTE: The meaning of connection is defined by the application.</p> </div>
Weighted Least Cumulative Traffic	<p>A tool port is selected from a port group based on the least total bytes sent to each tool port, as described under Least Cumulative Traffic.</p> <p>If the following command is enabled, link speed is considered with least cumulative traffic. If the following command is disabled, the weight configured for each port in the port group is considered with Least Cumulative Traffic.</p>
Hashing	A tool port is selected from a port list based on hashing of data provided by the GSOP

Metric	Description
	application, which is normally extracted from the packet. The values for hashing key are: IMSI GTP key (imsi), IMEI GTP key (imei), and MSISDN GTP key (msisdn). The hashing key only applies to the GTP stateful application. Refer to Hashing Key Support on page 672 for details.

Hashing Key Support

The following table describes the support for GTP hashing key.

GTP Key	Hashing	(Weighted) Least Bandwidth	(Weighted) Least Packet Rate	(Weighted) Least Round Robin	(Weighted) Least Connection	(Weighted) Least Cumulative Traffic
IMSI	Supported	Supported	Supported	Supported	Supported	Supported
IMEI	Supported	Not Supported	Not Supported	Not Supported	Not Supported	Not Supported
MSISDN	Supported	Not Supported	Not Supported	Not Supported	Not Supported	Not Supported

Configure Stateful Load Balancing

Use the Port Group page to specify the list of tool ports or tunnel endpoints for stateful load balancing and to enable load balancing in a port group.

To enable load balancing in a port group, do the following:

1. Select **Ports > Port Groups > All Port Groups**.
2. Click **New**.
3. In the Alias field, enter an alias. For example, load-balgrp.
4. Select **SMART Load Balancing**.
5. Use the Ports field to select the ports for this port group as shown in [Figure 399: Port Group Page to Set Ports for Load Balancing](#). Click Save when you are done.

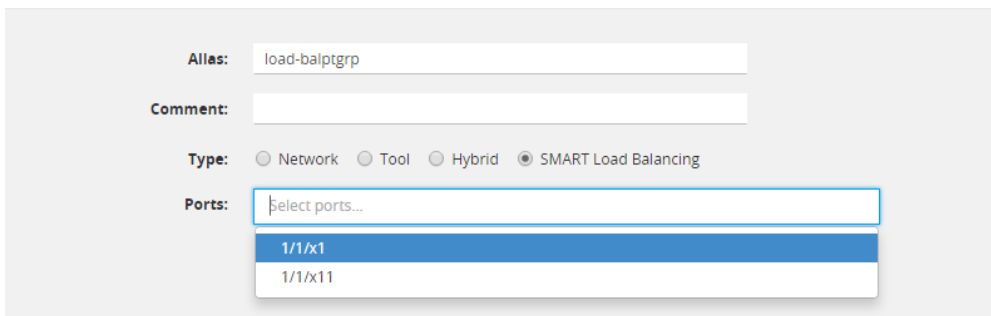


Figure 399: Port Group Page to Set Ports for Load Balancing

NOTES:

- Up to 50 load balancing port groups are supported, with a maximum of 256 ports for each group.
- Ports within port groups must be on the same chassis.
- Ports within port groups can have different rates.

Refer to the following examples:

- [Example 1: GigaSMART Stateful Load Balancing](#)
- [Example 2: GigaSMART Stateful Load Balancing](#)

For an example of load balancing on L2GRE encapsulation tunnel, refer to [Example 2 – GigaSMART L2GRE Tunnel Encap Stateful LB](#).

Example 1: GigaSMART Stateful Load Balancing

Example 1 configures stateful load balancing of GigaSMART GTP traffic among tool ports 1/1/x6, 1/1/x7, 1/2/x3, and 1/2/x4 based on bandwidth with different weights for each port. The same subscriber (imsi) traffic will be forwarded to the same tool port. GTP-c packets are replicated to all tool ports.

Task	Description	UI Steps
1.	Create a port group, specify the tool ports for load balancing, and weights for each tool port.	<ol style="list-style-type: none"> Select Ports > Port Groups. Click New Type portgrp1 in the Alias field. Select SMART Load Balancing Click in the Ports field to select the tool ports for the group. For example, 1/1/x6,1/1/x7,1/2/x3, and 1/2/x4. Specify the weights for each port as follows: weight 1/1/x6 5 weight 1/1/x7 10 weight 1/2/x3 20 weight 1/2/x4 10 Click Save.
2.	Create a GigaSMART group and specify a port and enable replicate GTP-c packets to all tool ports in the load balancing port group.	<ol style="list-style-type: none"> From the device view, select GigaSMART > GigaSMART Groups > GigaSMART Groups. Click New. Type gsgrp1 in the Alias field. Select the engine port. For example 1/3/e1. Under the Load Balance, select Replicate GTP-c. Click Save.

Task	Description	UI Steps
3.	Create a GSOP, including GTP application and load balancing metric.	<ol style="list-style-type: none"> a. From the device view, select GigaSMART > GigaSMART Operations (GSOP) > GigaSMART Operation. b. Click New. c. Type gsop1 in the Alias field d. Select gsgrp1 from the GigaSMART Groups list. e. Select the GigaSMART Operation Flow Filtering f. Select the GigaSMART Operation Load Balancing and set the operation as follows: <ul style="list-style-type: none"> • Select Stateful. • Select GTP for Type. • Select Weighted Least Bandwidth for the metric.
4.	Create a virtual port and associate it with the GigaSMART group.	<ol style="list-style-type: none"> a. From the device view, select GigaSMART > GigaSMART Operations (GSOP) > Virtual Ports. b. Click New. c. Type vp1 in the Alias field. d. Select gsgrp1 from the GigaSMART Group list. e. Click Save.
5.	<p>Create an ingress (first level) map. Note the following:</p> <ul style="list-style-type: none"> • You can specify only one port group as part of the map tool port in the to statement. • You can define the same load balancing port group in multiple maps, however, the load balancing metrics defined in the GSOPs on those maps have to be the same. • You cannot use a shared collector map for load balancing. <div style="border: 1px solid black; padding: 5px; margin-top: 10px;"> <p>NOTE: In the rules, 2123 is GTP-c traffic and 2152 is GTP-u traffic.</p> </div>	<ol style="list-style-type: none"> a. Select Maps > Maps > Maps. b. Click New. c. Type map11 in the Alias field. d. Select First Level for Type and By Rule for Subtype. e. Select port 1/1/x1 for the Source. f. Select virtual port vp1 for the Destination. g. Add Rule 1. <ul style="list-style-type: none"> • Click Add a Rule • Select Pass • Select Port Destination for the condition. • Set the port value to 2123. h. Add Rule 2. <ul style="list-style-type: none"> • Click Add a Rule • Select Pass • Select Port Destination for the condition. • Set the port value to 2125. i. Click Save.

Task	Description	UI Steps
6.	Create a second level map.	<ol style="list-style-type: none"> a. Select Maps > Maps > Maps. b. Click New. c. Type map22 in the Alias field. d. Select Second Level for Type and By Rule for Flow Filter. e. Select virtual port vp1 for the Source. f. Select port group portgrp1 for the Destination. g. Select gsop1 from the GSOP list. h. Click Add a Rule <ul style="list-style-type: none"> • Select Pass • Select GTP IMSI for the condition. • Enter 234567* for IMSI. • Select Any for Version. i. Click Save.

Example 2: GigaSMART Stateful Load Balancing

Example 2 configures stateful load balancing of GigaSMART GTP traffic among tool ports 1/1/x6, 1/1/x7, 1/2/x3, and 1/2/x4 based on hashing of the imei value. The same device ID (imei) traffic will be forwarded to the same tool port. GTP-c packets are replicated to all tool ports.

Step	Description	Command
1.	Create a port group and specify the tool ports for load balancing.	<ol style="list-style-type: none"> a. Select Ports > Port Groups. b. Click New c. Type portgrp1 in the Alias field. d. Select SMART Load Balancing e. Click in the Ports field to select the tool ports for the group. For example, 1/1/x6,1/1/x7,1/2/x3, and 1/2/x4. f. Click Save.
2.	Create a GigaSMART group and specify ports and enable replicate GTP-c packets to all tool ports in the load balancing port group.	<ol style="list-style-type: none"> a. From the device view, select GigaSMART > GigaSMART Groups > GigaSMART Groups. b. Click New. c. Type gsgrp1 in the Alias field. d. Select the engine port. For example 1/3/e1. e. Under the Load Balance, select Replicate GTP-c. f. Click Save.
3.	Create a GSOP, including GTP application and load balancing metric.	<ol style="list-style-type: none"> a. From the device view, select GigaSMART > GigaSMART Operations (GSOP) > GigaSMART Operations.

Step	Description	Command
		<ul style="list-style-type: none"> b. Click New. c. Type gsop1 in the Alias field d. Select gsgrp1 from the GigaSMART Groups list. e. Select the GigaSMART Operation Flow Filtering f. Select the GigaSMART Operation Load Balancing. g. Configure Load Balancing as follows: <ul style="list-style-type: none"> • Select Stateful. • Select GTP for Type. • Select Hashing for the metric. • Select IMEI h. Click Save.
4.	Create a virtual port and associate it with the GigaSMART group.	<ul style="list-style-type: none"> a. From the device view, select GigaSMART > GigaSMART Operations (GSOP) > Virtual Ports. b. Click New. c. Type vp1 in the Alias field. d. Select gsgrp1 from the GigaSMART Groups list. e. Click Save.
5.	<p>Create an ingress (first level) map. Note the following:</p> <ul style="list-style-type: none"> • You can specify only one port group as part of the map tool port in the to statement. • You can define the same load balancing port group in multiple maps, however, the load balancing metrics defined in the GSOPs on those maps have to be the same. • You cannot use a shared collector map for load balancing. <div style="border: 1px solid black; padding: 5px; margin-top: 10px;"> <p>NOTE: In the rules, 2123 is GTP-c traffic and 2152 is GTP-u traffic.</p> </div>	<ul style="list-style-type: none"> a. Select Maps > Maps > Maps. b. Click New. c. Type map11 in the Alias field. d. Select First Level for Type and By Rule for Subtype. e. Select port 1/1/x1 for the Source. f. Select virtual port vp1 for the Destination. g. Add Rule 1. <ul style="list-style-type: none"> • Click Add a Rule • Select Pass • Select Port Destination for the condition. • Set the port value to 2123. h. Add Rule 2. <ul style="list-style-type: none"> • Click Add a Rule • Select Pass • Select Port Destination for the condition. • Set the port value to 2125. i. Click Save.

Step	Description	Command
6.	Create a second level map.	<ol style="list-style-type: none"> a. Select Maps > Maps > Maps. b. Click New. c. Type map22 in the Alias field. d. Select Second Level for Type and By Rule for Flow Filter. e. Select virtual port vp1 for the Source. f. Select port group portgrp1 for the Destination. g. Select gsop1 from the GSOP list. h. Click Add a Rule <ul style="list-style-type: none"> • Select Pass • Select GTP IMSI for the condition. • Enter 234567* for IMSI. • Select Any for Version. i. Click Save.

Stateless Load Balancing

Stateless load balancing distributes GigaSMART processed traffic to multiple tools based on predefined protocol fields in the packet.

Unlike stateful load balancing, stateless load balancing can be configured together with most other GigaSMART operations or as a separate GigaSMART operation to provide more flexible traffic distribution options over what is available from a tool GigaStream. Packets processed by stateless load balancing are forwarded to a tool port within a port group.

Stateless load balancing supports packets with MPLS encapsulation and IEEE 802.1 Q-in-Q VLAN tags.

For details on stateless load balancing, refer to the following sections:

- [Stateless Load Balancing Metrics](#)
- [Configure Stateless Load Balancing](#)

To select stateless load balancing, do the following:

1. From the device view, select **GigaSMART > GigaSMART Operations (GSOP) GigaSMART Operation**, and then click **New**.
2. Type an alias in the **Alias** field.
3. From the **GigaSMART Groups** drop-down list, select a GigaSMART group.
4. From the **GigaSMART Operations (GSOP)** drop-down list, select **Load Balancing**.
5. Configure Load Balancing:

- Select **Stateless**
- Specify a load balancing metric. For example, **IP Only** as shown in [Figure 398: Configuring Stateful Load Balancing](#).

6. Click **Save**.

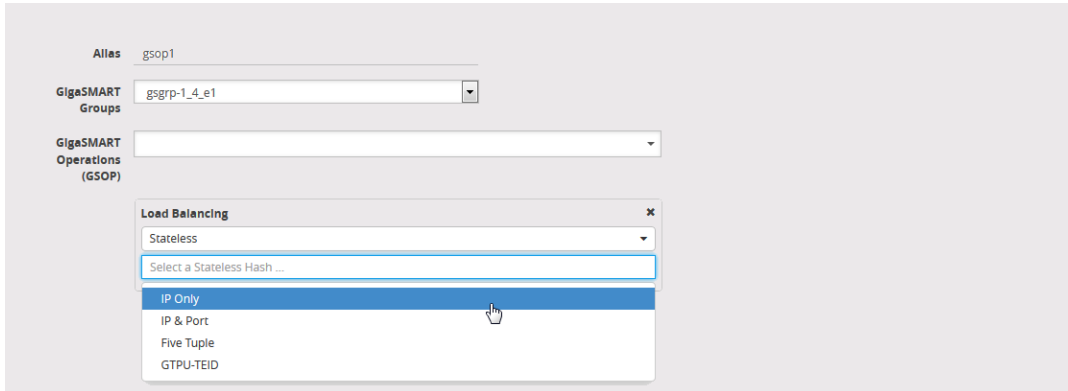


Figure 400: Selecting Stateless Load Balancing

For more information, refer to the following sections:

- [Stateless Load Balancing Metrics](#)
- [Configure Stateless Load Balancing](#)

Stateless Load Balancing Metrics

The load balancing metrics available for stateless load balancing are described in the following table.

A tool port is selected from a port list based on hashing. The fields to be hashed are described in the table.

To specify a metric for stateless load balancing:

1. From the device view, select **GigaSMART > GigaSMART Operations (GSOP) > GigaSMART Operation**.
2. Click **New** to create a new GigaSMART Operation or **Edit** to modify an existing one.
3. Select **Load Balancing** from the **GigaSMART Operations (GSOP)** drop-down list and configure load balancing as follows.
 - a. Select **Stateless**
 - b. Select one of the hashing metrics: IP Only, IP & PORT, Five Tuple, or GTPU-TEID.

[Table 61: Stateless Load Balancing Metrics](#) describes each of the metrics.

4. Click **Save**.

Table 61: Stateless Load Balancing Metrics

Metric	Description
IP Only	The source IP and destination IP addresses.
IP & Port	The source IP and destination IP addresses, and Layer 4 source port and destination port numbers.
Five Tuple	The source IP and destination IP addresses, source port and destination port numbers, and protocol field in the IP header.
GTPU-TEID	The GTP-u tunnel identifier (ID). NOTE: There is no inner or outer field location for GTPU-TEID .
outer	The first occurrence of header or field. For example, IP Only outer is the first IP header in the packet, which could be IPv4 or IPv6.
inner	The second occurrence of header or field. For example, ip-only inner is the second IP header in the packet. The first IP header could be IPv4 or IPv6, as follows: <ul style="list-style-type: none"> • IPv4-IPv4—IP Only inner is the IP addresses in the second IPv4 header • IPv6-IPv4—IP Only inner is the IP addresses in the IPv4 header • IPv4-IPv6—IP-Only inner is the IP addresses in the IPv6 header The supported IP encapsulation types are: IP-in-IP, VXLAN, GTP, GRE, and ERSPAN.

Configure Stateless Load Balancing

To configure stateless load balancing, specify the group of tool ports and enable load balancing in a port group.

1. Select **Ports > Port Groups > All Port Groups**.
2. Click **New**.
3. Type an alias in the **Alias** field. For example, load-balgrp.
4. Select **SMART Load Balancing**.
5. Use the Ports field to select the ports for this port group as shown in [Figure 399: Port Group Page to Set Ports for Load Balancing](#). Click **Save** when you are done.

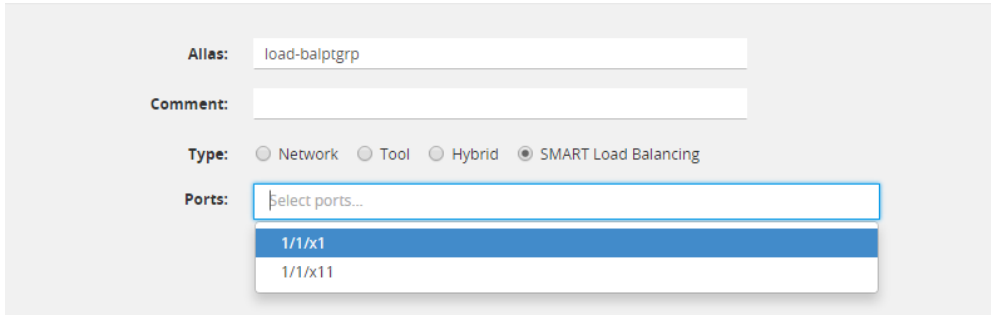


Figure 401: Port Group Page to Set Ports for Load Balancing

Notes:

- Up to 50 load balancing port groups are supported, with a maximum of 256 ports for each group.
- Ports within port groups must be on the same chassis.
- Ports within port groups can have different rates.

Refer to the following examples:

- [Example 1: GigaSMART Stateless Load Balancing](#)
- [Example 2: GigaSMART Stateless Load Balancing](#)
- [Example 3: GigaSMART Stateless Load Balancing](#)

For an example of load balancing on L2GRE encapsulation tunnel, refer to [Example 3 – GigaSMART L2GRE Tunnel Encap Stateless LB](#).

Example 1: GigaSMART Stateless Load Balancing

Example 1 configures stateless load balancing of traffic among tool ports 1/1/x6, 1/1/x7, 1/2/x3, and 1/2/x4 after slicing the packet to an offset of 70 bytes.

Step	Description	Command
1.	Create a port group and specify the tool ports for load balancing.	<ol style="list-style-type: none"> Select Ports > Port Groups. Click New Type portgrp1 in the Alias field. Select SMART Load Balancing Click in the Ports field to select the tool ports for the group. For example, 1/1/x6,1/1/x7,1/2/x3, and 1/2/x4. Click Save.
2.	Configure a GigaSMART group and associate it with GigaSMART engine ports.	<ol style="list-style-type: none"> From the device view, select GigaSMART > GigaSMART Groups > GigaSMART Groups. Click New.

Step	Description	Command
		<ul style="list-style-type: none"> c. Type gsgrp1 in the Alias field. d. Select the engine ports. For example 1/3/e1 and 1/3/e2. e. Click Save.
3.	<p>Create a GSOP, with load balancing.</p>	<ul style="list-style-type: none"> a. From the device view, select GigaSMART > GigaSMART Operations (GSOP) > Operations. b. Click New. c. Type lbiponlyouter in the Alias field d. Select gsgrp1 from the GigaSMART Groups list. e. Select the GigaSMART Operation Slicing. f. Configure Slicing as follows: <ul style="list-style-type: none"> • Select Stateful. • Select None for protocol • Set Offset to 70. g. From the device view, select GigaSMART Operation Load Balancing. h. Configure Load Balancing as follows: <ul style="list-style-type: none"> • Select Stateless • Select IP Only Outer for the hash metric i. Click Save.
4.	<p>Create a first level map.</p> <p>Note the following:</p> <ul style="list-style-type: none"> • You can specify only one port group as part of the map tool port in the to statement. • You can define the same load balancing port group in multiple maps, however, the load balancing metrics defined in the GSOPs on those maps have to be the same. • You cannot use a shared collector map for load balancing. 	<ul style="list-style-type: none"> a. Select Maps > Maps > Maps. b. Click New. c. Type map1 in the Alias field. d. Select First Level for Regular and By Rule for Subtype. e. Select port 1/1/x1 for the Source. f. Select port group portgrp1 for the Destination. g. Select lbiponlyouter from the GSOP list. h. Click Add a Rule <ul style="list-style-type: none"> • Select Pass • Select IP Version for the condition. • Select v4 for Version. i. Click Save.

Example 2: GigaSMART Stateless Load Balancing

Example 2 configures stateless load balancing of GTP traffic among tool ports 1/1/x6, 1/1/x7, 1/2/x3, and 1/2/x4. Data packets with the same GTP-u tunnel ID will be forwarded to the same tool port.

Step	Description	Command
1.	Create a port group and specify the tool ports for load balancing.	<ol style="list-style-type: none"> Select Ports > Port Groups. Click New Type portgrp1 in the Alias field. Select SMART Load Balancing Click in the Ports field to select the tool ports for the group. For example, 1/1/x6,1/1/x7,1/2/x3, and 1/2/x4. Click Save.
2.	Configure a GigaSMART group and associate it with GigaSMART engine ports.	<ol style="list-style-type: none"> From the device view, select GigaSMART > GigaSMART Groups > GigaSMART Groups. Click New. Type gsgrp1 in the Alias field. Select the engine ports. For example 1/3/e1 and 1/3/e2. Click Save.
3.	Create a GSOP, including load balancing metric.	<ol style="list-style-type: none"> From the device view, select GigaSMART > GigaSMART Operations (GSOP) > GigaSMART Operations. Click New. Type gsop1 in the Alias field Select gsgrp1 from the GigaSMART Groups list. Select the GigaSMART Operation Load Balancing. Configure Load Balancing as follows: <ul style="list-style-type: none"> Select Stateless Select GTPU-TEID for the hash metric Click Save.
4.	<p>Create first level maps.</p> <p>Note the following:</p> <ul style="list-style-type: none"> You can specify only one port group as part of the map tool port in the to statement. You can define the same load balancing port group in 	<p>Create the first map:</p> <ol style="list-style-type: none"> Select Maps > Maps > Maps. Click New. Type map1 in the Alias field. Select First Level for Regular and By Rule for Subtype. Select port 1/1/x1 for the Source. Select port group portgrp1 for the Destination. Click Add a Rule, and then select Pass Select IPv4 Protocol for the first condition.

Step	Description	Command
	<p>multiple maps, however, the load balancing metrics defined in the GSOPs on those maps have to be the same.</p> <ul style="list-style-type: none"> You cannot use a shared collector map for load balancing. 	<ol style="list-style-type: none"> i. Select UDP for Value j. Select Port Destination for the second condition. k. Enter 2123 for the port value. l. Click Save. <p>Create the second map:</p> <ol style="list-style-type: none"> a. Select Maps > Maps > Maps. b. Click New. c. Type map1 in the Alias field. d. Select First Level for Regular and By Rule for Subtype. e. Select port 1/1/x1 for the Source. f. Select port group portgrp1 for the Destination. g. Select gsop1 from the GSOP list. h. Click Add a Rule, and then select Pass i. Select IPv4 Protocol for the first condition. j. Select UDP for Value k. Select Port Destination for the second condition. l. Enter 2152 for the port value. m. Click Save.

Example 3: GigaSMART Stateless Load Balancing

Example 3 configures stateless load balancing of HTTP on GTP traffic among tool ports 1/1/x6, 1/1/x7, 1/2/x3, and 1/2/x4. Data packets with the same inner IP will be forwarded to the same tool port.

Step	Description	Command
1.	Create a port group and specify the tool ports for load balancing.	<ol style="list-style-type: none"> a. Select Ports > Port Groups. b. Click New c. Type portgrp1 in the Alias field. d. Select SMART Load Balancing e. Click in the Ports field to select the tool ports for the group. For example, 1/1/x6,1/1/x7,1/2/x3, and 1/2/x4. f. Click Save.
2.	Configure a GigaSMART group and associate it with GigaSMART engine ports.	<ol style="list-style-type: none"> a. From the device view, select GigaSMART > GigaSMART Groups > GigaSMART Groups. b. Click New. c. Type gsgrp1 in the Alias field. d. Select the engine ports. For example 1/3/e1 and 1/3/e2.

Step	Description	Command
3.	Create a GSOP, including load balancing metric.	<p>e. Click Save.</p> <p>f. From the device view, select GigaSMART > GigaSMART Operations (GSOP) > GigaSMART Operation.</p> <p>g. Click New.</p> <p>h. Type gsop1 in the Alias field</p> <p>i. Select gsgrp1 from the GigaSMART Groups list.</p> <p>j. Select the GigaSMART Operation Load Balancing.</p> <ul style="list-style-type: none"> • Select Stateless • Select IP Only Inner for the hash metric <p>k. Click Save.</p>
4.	<p>Create first level maps.</p> <p>Note the following:</p> <ul style="list-style-type: none"> • You can specify only one port group as part of the map tool port in the to statement. • You can define the same load balancing port group in multiple maps, however, the load balancing metrics defined in the GSOPs on those maps have to be the same. • You cannot use a shared collector map for load balancing. 	<p>Create the first map:</p> <ul style="list-style-type: none"> a. Select Maps > Maps > Maps. b. Click New. c. Type map1 in the Alias field. d. Select Regular for Type and By Rule for Subtype. e. Select port 1/1/x1 for the Source. f. Select port group portgrp1 for the Destination. g. Click Add a Rule, and then select Pass h. Select IPv4 Protocol for the first condition. i. Select UDP for Value j. Select Port Destination for the second condition. k. Enter 2123 for the port value. l. Click Save. <p>Create the second map:</p> <ul style="list-style-type: none"> a. Select Maps > Maps > Maps. b. Click New. c. Type map1 in the Alias field. d. Select First Level for Regular and By Rule for Subtype. e. Select port 1/1/x1 for the Source. f. Select port vp1 for the Destination. g. Select gsop1 from the GSOP list. h. Click Add a Rule, and then select Pass i. Select IPv4 Protocol for the first condition. j. Select UDP for Value k. Select Port Destination for the second condition. l. Enter 2152 for the port value. m. Click Save.

Step	Description	Command
5.	Create the second level map.	Create the third map: <ol style="list-style-type: none"> a. Select Maps > Maps > Maps. b. Click New. c. Type map22 in the Alias field. d. Select Second Level for Type and By Rule for Subtype. e. Select virtual vp1 for the Source. f. Select port group portgrp1 for the Destination. g. Select gsop1 from the GSOP list. h. Click Add a Rule, and then select Pass i. Select IPv4 Destination for the first condition. j. Enter 80 for the destination value. k. Select 2 for position. l. Click Save.

Enhanced Load Balancing

Required License: Enhanced Load Balancing

GigaSMART Enhanced Load Balancing supports evenly distributed traffic among multiple tool ports based on one or more user defined fields. When a tool port fails, the traffic is redistributed just for that tool port to other member tool ports. When the failed tool port recovers, the traffic that was redistributed is restored to the recovered tool port. Traffic across other member tool ports remain undisturbed during this process.

Traffic Handling and Load Balancing Distribution

- Non GTP traffic and (subsequent) fragmented packets to be load balanced to all tool ports based on outer IP.
- Rebalance traffic when the following occurs:
 - Tool port goes up or down
 - Tool port group membership changes
 - When a tool port fails redistribute the traffic just for that tool port and when the failed tool port recovers restore traffic just for that tool port
 - No tool port within the port group receives more than 5% of average traffic based on the enhanced load balancing metric defined

Enhanced Load Balancing Metrics

GigaSMART provides configuration support for a new enhanced load balancing (enhanced-lb) app. The enhanced-lb app allows users to define the fields used for load balancing.

Enhanced Load Balancing supports the following hashing metrics:

- inner IP address
- outer IP address
- inner L4 port
- outer L4 port
- GPRS Tunnel Endpoint Identifier (TEID)

Configure Enhanced Load Balancing

To configure enhanced load balancing, do the following:

1. Select >**Physical**.
2. Click on a node you want apply enhance load balancing.
3. Select **GigaSMART>Enhanced Load Balancing**. The enhance load balance screen displays.
4. Click **New**. The enhanced load balancing screen appears.

ALIAS*
Test1

+ - Hash Field Name Hash Field Location
IP Inner

5. Enter an Alias.
6. Select the Hash Field Name. The following options are available:
 - IP
 - L4 Port
 - GTP-U TEID
7. Select Hash Field Location. Options:
 - inner
 - outer

NOTE: Use the "+" or "-" icons to add and delete hash fields.

Hash Field Name	Hash Field Location
IP	Inner
IP	Outer
L4 Port	Outer
L4 Port	Inner
GTP-U TEID	None

You can configure up to five (5) different hash fields and location.

- Click **OK**.

NOTE: To view details about the enhanced load balancing parameters, click the **Alias**. The detail/edit dialog box displays.

Configure GigaSMART Operation (GSOP)

- Select > **Physical**.
- Select **GigaSMART > GSOP**.
- Click **New**.
- Enter **Alias**.
- Select a GSOP Group.
- Select a GSOP type: **Load Balancing**.
- Select GSOP type: Enhance load balancing. The Load Balancing dialog appears.

Load Balancing ✕

Load Balance Type Stateful Stateless Enhanced

- Select **Enhanced**.
- Select an Enhanced Load Balance Alias from the drop-down. This is the enhanced load balance you previously created.

Load Balancing ✕

Load Balance Type Stateful Stateless Enhanced

Enhanced Load Balance Alias Test01 ▼

10. Click **OK**. The enhanced load balance GSOP is now available on the GSOP page.

GigaSMART De-Duplication

Required License: De-Duplication

GigaSMART de-duplication detects duplicates of the following types:

- IPv4 packets
- IPv6 packets
- non-IP packets (including non-IPv4 and non-IPv6 packets)

Duplicates are packets in which the fields (including the headers and payload) are the same, with the exception of some field such as Time-to-Live (TTL). For example, if two packets are identical except for TTL, they will be counted as duplicates.

Duplicate packets are common in network analysis environments where both the ingress and egress data paths are sent to a single output (for example, as a result of a SPAN operation on a switch). They can also appear when packets are gathered from multiple collection points along a path. GigaSMART de-duplication lets you eliminate these packets, only forwarding a packet once and thus reducing the processing load on your tools.

There are two actions that can be specified for handling the duplicate packets detected:

- drop, which drops the duplicate packets
- count, which counts the duplicate packets, but does not drop them

A time interval can be configured within which an identical packet will be considered a duplicate. The greater the interval over which traffic can be checked for duplicates, the higher the accuracy of the de-duplication detection and subsequent elimination.

For example, if two of the same packets are seen in the specified time interval, the packets will be detected as duplicates. If one packet is seen in the time interval and another packet is seen in a later time interval, the packets will not be detected as duplicates.

For IPv4 and IPv6 packets, to determine if a packet is considered to be a duplicate, parts of the IP headers (Layer 3 and Layer 4), as well as the payload are compared.

For non-IP packets, a packet is considered to be a duplicate if it is identical.

Keep in mind the following when configuring GigaSMART de-duplication:

Feature	Description
Layer 2 Retransmissions Not Removed	Valid Layer 2 retransmissions are part of normal network behavior and are not removed by the de-duplication feature. Layer 2 retransmissions will show differences in the IP Window ID field.
Encapsulated Duplicates Not Removed	If the same packet is seen once with encapsulation (for example, GRE) and once without encapsulation, the GigaSMART will not detect and remove the duplicate.
No NAT or PAT	Packets tapped on opposite sides of a NAT or PAT boundary will differ in the Network layer and will not be detected as duplicates.
MPLS and VLAN Tags	De-duplication properly parses VLAN and MPLS tags to get to the IP headers.
VN-Tag Packets	VN-Tag packets are treated as non-IP packets. User Header Stripping to strip VN-Tag to get to the IP headers for de-duplication. Refer to GigaSMART Header Stripping .
GigaSMART Engine Ports	De-duplication operations can be assigned to GigaSMART groups consisting of multiple engine ports. Refer to Groups of GigaSMART Engine Ports for details.

De-Duplication Configuration Steps

To configure de-duplication, use the following steps:

- Configure GigaSMART parameters on a specified GigaSMART group.
- Configure a GigaSMART operation.
- Configure a map that will use the de-duplication GigaSMART operation. This ties de-duplication to rules defined in a flow map, which applies the GigaSMART operation to specific traffic flows.

These steps are detailed in [Example – GigaSMART De-Duplication](#).

Configure GigaSMART Parameters for Packet De-Duplication

Use the **Dedup** section under GigaSMART Parameters on the GigaSMART Groups configuration page to configure options for GigaSMART de-duplication operations. The following table describes the configuring parameters for de-duplication on a specified GigaSMART group:

Parameter	Description
Action	<p>Specifies whether duplicate packets are to be counted or dropped as follows:</p> <ul style="list-style-type: none"> Count – GigaSMART counts the duplicate packets, but does not drop them. Drop – GigaSMART drops the duplicate packets. <p>The default is drop.</p>
IP Tclass IP TOS TCP Sequence VLAN	<p>These options are useful when applying de-duplication operations to packets in a NAT environment. Different NAT implementations can change certain packet header fields (for example, the TCP sequence number). If you want to be able to detect duplicates without requiring that these fields match (ToS field, TCP sequence number, VLAN ID), you can disable the corresponding option.</p> <ul style="list-style-type: none"> IP Tclass – Ignore or include IPv6 traffic class. Use for IPv6. The default is include. IP TOS – Ignore or include the IP ToS bits when detecting duplicates. Use for IPv4. The default is include. TCP Sequence – Ignore or include the TCP Sequence number when detecting duplicates. The default is include. VLAN – Ignore or include the VLAN ID when detecting duplicates. The default is ignore. <p>Include means the field will be included when GigaSMART compares packets.</p> <p>Ignore means the field will be ignored when GigaSMART compares packets.</p>
Timer <Value: 10-500000 μs>	<p>Configures the time interval within which an identical packet will be considered a duplicate. The greater the interval over which traffic can be checked for duplicates, the higher the accuracy of the de-duplication detection and subsequent elimination.</p> <p>The default is 50,000μs.</p> <p>For example, if two same packets are seen in the specified time interval, the packets will be detected as duplicates. If one packet is seen in the time interval and another packet is seen in a later time interval, the packets will not be detected as duplicates.</p> <p>NOTE: Retransmissions are not counted as duplicates.</p>

Example – GigaSMART De-Duplication

To access GigaSMART within GigaVUE-FM, access a device that has been added to GigaVUE-FM from the GigaVUE-FM interface. GigaSMART appears in the navigation pane of the device view on supported devices. Refer to [Access GigaSMART from GigaVUE-FM](#) for details.

This example shows the configuration steps for a de-duplication operation in which the GigaSMART application drops duplicate packets.

Task	Description	UI Steps
1.	Configure a GigaSMART group and associate it with a GigaSMART engine port.	<ol style="list-style-type: none"> a. From the device view, select GigaSMART > GigaSMART Groups. b. Click New. c. Type an alias in the Alias field. For example, gs2port1. d. Click in Port List field and select an engine port. For example, 2/1/e1. e. Go to Task 2.
2.	Configure parameters on the GigaSMART group.	<ol style="list-style-type: none"> a. Under the Dedup section on the GigaSMART Group configuration page, set the parameters as the follows: Action: drop IP Tclass: Include IP TOS: Ignore TCP Sequence: Ignore Vlan: Ignore Timer (us) 500000 b. Click Save.
3.	Configure the GigaSMART operation for de-duplication and assign it to the GigaSMART group.	<ol style="list-style-type: none"> a. From the device view, select GigaSMART > GigaSMART Operations (GSOP) > GigaSMART Operation. b. Click New. c. Type a name for the operation in the alias field. For example, testdedup. d. Select the GigaSMART Group create in task 1. e. Select Deduplication from the GigaSMART Operations (GSOP) list and select Enable. f. Click Save.
4.	Create a map.	<ol style="list-style-type: none"> a. Select Maps > Maps > Maps. b. Click New. c. Type an alias in the Map Alias field that will help you identify this map. For example, testingdedup d. Select Regular and By Rule for the map type and subtype. e. Specify the network and tool ports in the Source and Destination fields. For example, 2/2/x4 and 2/2/x6 for Source and 2/2/x9 for Destination. f. From the GigaSMART Operation (GSOP) drop-down list, select the GigaSMART operation configured in Task 3. For example, testdedup in this example. g. Click Add a Rule under Map Rules and create the following rule: Select Pass, then select Bi Directional, and then select

Task	Description	UI Steps
		Port Source from the drop-down list and set the Min to 0 and Max to 443. h. Click Save.

Display De-Duplication Statistics

To display the statistics for de-duplication in a cluster environment, select **GigaSMART > GigaSMART Operations (GSOP) > Statistics**. The de-duplications statistics will be in the row labeled Dedup in the GS Operations column.

Refer to [De-duplication Statistics Definitions](#) for descriptions of these statistics as well as to [GigaSMART Operations Statistics Definitions](#).

GigaSMART MPLS Traffic Performance Enhancement

GigaSMART MPLS Traffic Performance Enhancement does not require a separate license.

The GigaSMART MPLS traffic performance enhancement provides a method to improve GigaSMART packet processing for MPLS traffic and other traffic having Layer 2 encapsulation, such as L2GRE or VNTag. This type of traffic has a header in the packet between the MAC address and the IP address. [Figure 402: MPLS Header Between MAC and IP Address in Packet](#) shows the MPLS example.



Figure 402: MPLS Header Between MAC and IP Address in Packet

The GigaSMART processor is able to identify IP flows if there is only the MAC address and no other header in the packet before the IP address or if the only header before the IP address is VLAN. Without this enhancement, the GigaSMART processor cannot identify IP flows if there are MPLS headers or Layer 2 encapsulation other than VLAN before the IP address.

Performance is impacted if the GigaSMART processor cannot use the IP source and destination (ipsrc, ipdst) to identify flows. This enhancement provides another method to identify flows. Using a flow mask, you select the portion of the packet for flow identification.

The flow mask consists of an offset and a length, in bytes. Use the offset to specify the number of bytes from the beginning of the packet to the start of the mask within the packet. Use the length to specify the number of bytes, following the offset, to mask within the packet. The length identifies the traffic flow.

Both the offset and the length are variable; however, the offset plus the length cannot be greater than 112 bytes.

A default mask is provided with an offset of 14 bytes and a length of 28 bytes.

To access GigaSMART within GigaVUE-FM, access a device that has been added to GigaVUE-FM from the GigaVUE-FM interface. **GigaSMART** appears in the navigation pane of the device view on supported devices. Refer to the [Access GigaSMART from GigaVUE-FM](#) for details.

To configure the MPLS traffic performance enhancement, do the following:

1. From the device view, select **GigaSMART > GigaSMART Group > GigaSMART Groups**.
2. Click **New** to create a new GigaSMART group or **Edit** to modify an existing one.
3. Go to Flow Mask under GigaSMART Parameters and select **Enable**.
4. Enter the offset and length in the **Offset (bytes)** and **Length (bytes)** fields.
If you do not enter any values in these fields, the default offset and length is used.
5. Click **Save**.

Refer to the following sections for examples:

- [Flow Masking Example 1](#)
- [Flow Masking Example 2](#)

Flow Masking Example 1

In Example 1 packets are expected to have two MPLS labels before the IP header, and no VLAN tag between the MAC and MPLS headers. IP addresses will be used to identify the flows.

The offset will be the sum of the following: 14 bytes for the MAC address + 8 bytes for the MPLS headers + 12 bytes offset from the beginning of the IP header = 34 bytes.

The length will be the sum of the following: 4 bytes for ipsrc + 4 bytes for ipdst = 8 bytes.

To access GigaSMART within GigaVUE-FM, access a device that has been added to GigaVUE-FM from the GigaVUE-FM interface. **GigaSMART** appears in the navigation pane of the device view on supported devices. Refer to the [Access GigaSMART from GigaVUE-FM](#) for details.

To configure Example 1, do the following:

1. From the device view, select **GigaSMART > GigaSMART Groups > GigaSMART Groups**.
2. Click **New** to create a new GigaSMART Group or **Edit** to modify an exiting one.
3. Under GigaSMART Parameters, go to Flow Mask and select **Enable**.

4. Enter 34 in the **Offset (bytes)** field and 8 in the **Length (bytes)** field as shown in the following figure

▼ Flow Mask

Enable

Offset (bytes)

Length (bytes)

5. Click **Save**.

Flow Masking Example 2

In Example 2, packets are expected to have one VLAN tag and two MPLS labels before the IP header. IP addresses will be used to identify the flows.

The offset will be the sum of the following: 14 bytes for the MAC address + 4 bytes for the VLAN tag + 8 bytes for the MPLS headers + 12 bytes offset from the beginning of the IP header = 38 bytes.

The length will be the sum of the following: 4 bytes for ipsrc + 4 bytes for ipdst = 8 bytes.

To access GigaSMART within GigaVUE-FM, access a device that has been added to GigaVUE-FM from the GigaVUE-FM interface. **GigaSMART** appears in the navigation pane of the device view on supported devices. Refer to the [Access GigaSMART from GigaVUE-FM](#) for details.

To configure Example 2, do the following:

To configure Example 1, do the following:

1. From the device view, select **GigaSMART > GS Groups > GS Groups**.
2. Click **New** to create a new GigaSMART Group or **Edit** to modify an existing one.
3. Click **Enable** under GS Params Flow Mask.
4. Enter 38 in the **Offset (bytes)** field and 8 in the **Length (bytes)** field as shown in the following figure.

▼ Flow Mask

Enable

Offset (bytes)

Length (bytes)

5. Click **Save**.

GigaSMART Header Stripping

Required License: Header Stripping

GigaSMART operations with a **Strip Header** component can identify and remove headers from tagged packets or headers and trailers from tunneled (encapsulated) packets. The following types of packets can be stripped:

- **Header Stripping** – Remove headers from ERSPAN, MPLS, MPLS+VLAN, VLAN, VN-Tag, VXLAN, GRE, tagged packets, Cisco FabricPath Headers, or FM6000 timestamps before they are sent to tool ports. This feature is handy when working with tools that either cannot recognize these headers or have to engage in additional processing to adjust for them. [Figure 403: Strip Header GigaSMART Operation Configured](#) shows the GigaSMART Operations page for configuring header stripping.
- **Tunnel Stripping** – Remove both the header and trailer of ISL or GTP-encapsulated packets, preserving the packet within for analysis. This is handy when sending data to tools that cannot parse the ISL or GTP tunnel information and analyze the packets within. [Figure 404: Tunnel Stripping GigaSMART Operation Configured](#) shows an example of the GS Operations page configured for tunnel stripping.

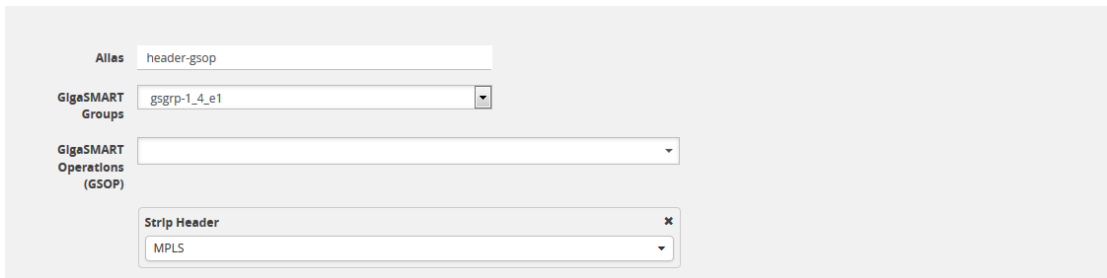


Figure 403: Strip Header GigaSMART Operation Configured

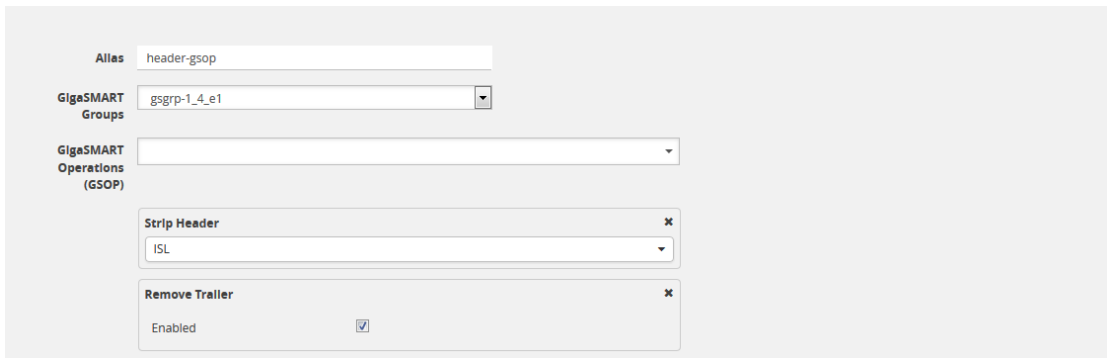


Figure 404: Tunnel Stripping GigaSMART Operation Configured

You can also use the **Strip Header** feature in tandem with the **Add VLAN** component to differentiate stripped packets from non-stripped packets. This is particularly useful when seeing stripped/non-stripped packets on common IP ranges (10.x.x.x; 192.168.x.x). Refer to the following table for more information.

Keep in mind the following when configuring GigaSMART operations with a **Strip Header** component:

Summary	Description
ERSPAN Header Stripping	<p>The ERSPAN header can be stripped. Specify an ERSPAN flow ID, from 0 to 1023. Use this option to strip ERSPAN Type II and Type III headers. A flow ID of zero is a wildcard value that matches all flow IDs.</p>
Cisco FabricPath Header Stripping	<p>The Cisco FabricPath headers can be stripped. The ability to decapsulate all packets with Cisco FabricPath headers; that is, all packets matching a destination switch ID and source switch ID. Also apply filters based on outer src/dst switch ID or ability to filter based on inner packet parameters with or without decapsulating the packet.</p> <p>The Fabric Switch ID Source and Fabric Switch ID Destination attributes are mandatory. Enter a value from 0 to 4095 ($<0\sim(2^{12}-1)>$) for a 12-bit switch ID. Enter 0 to strip all switch IDs.</p>
FM6000 Timestamp Header Stripping	<p>Packets entering GigaSMART from other devices may contain FM6000 timestamps. FM6000 is an Intel chip used for timestamping. The FM6000 timestamp can be stripped or it can be converted to UTC and appended to one of two Gigamon timestamping trailer formats.</p> <p>FM6000 has a hardware timestamp in the packet. For GigaSMART, the hardware timestamp needs to be translated into UTC time. An FM6000 device sends time mapping information in separate control packets called keyframes, which enable the UTC timestamp to be calculated. The calculated UTC timestamp can then be appended to the packets as a trailer.</p> <p>There are three timestamp formats: None, or GigaSMART, and X12-TS (for PRT-H00-X12TS). If the timestamp format is None, the FM6000 timestamp is stripped from the packet. If the timestamp format is GigaSMART or X12-TS, the FM6000 timestamp is stripped, converted to UTC, and a trailer containing the UTC timestamp is appended to the packets.</p> <p>The GigaSMART timestamp is added to the GigaSMART trailer. For the format of the GigaSMART trailer, refer to GigaSMART Trailer Reference. The X12-TS timestamp is added to the PRT-H00-X12TS trailer. For the format of the PRT-H00-X12TS trailer, refer to <i>GigaVUE-OS-CLI Reference Guide</i>.</p> <p>NOTES:</p> <ul style="list-style-type: none"> • FM6000 timestamp header stripping only supports an FM6000 timestamp that is present in the packet before the Frame Check Sequence (FCS). Packets containing an FM6000 timestamp that overwrites the existing FCS are discarded. Packets with a bad FCS are also discarded. • Keyframes must only be sent to GigaSMART from one FM6000 device. If there are multiple FM6000 devices, their clocks must be

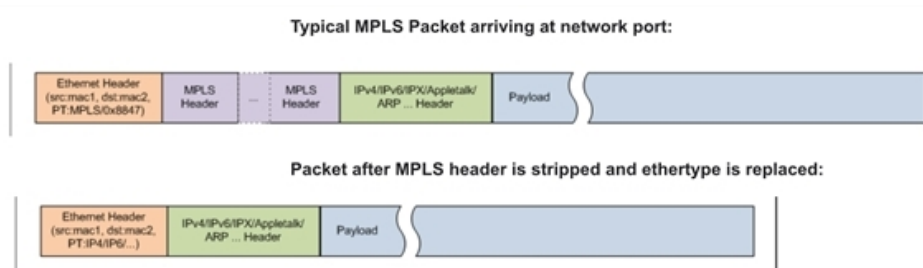
Summary	Description
	<p>synchronized using PTP.</p> <ul style="list-style-type: none"> The GigaVUE node maintains the keyframe database per GigaSMART operation (gsop). There is a one-to-one mapping of the keyframe database to each map associated with an FM6000 gsop. Ten (10) maps with an FM6000 gsop are supported per GigaSMART engine. The keyframe rate on the FM6000 device is important. If GigaSMART does not see the keyframe, the time that is converted and appended to the header will be a default start time (1969). In certain conditions, the keyframe rate on the FM6000 device might need to be increased so that GigaSMART does not miss seeing this frame. <p>For an FM6000 timestamping example, refer to Example – FM6000 Timestamping.</p>
GRE Header Stripping	<p>By specifying a GigaSMART Operation with a GSOP type of Strip Header GRE, the GigaSMART can strip GRE headers. It will automatically strip either Layer 3 or Layer 2 headers depending on the incoming packet.</p> <p>Layer 3 – The GigaSMART can strip the outer IPv4 delivery header and the GRE header to expose the encapsulated packet. Only IPv4 as the delivery protocol is supported. Any packet inside the GRE tunnel will be exposed, including IPv6 payloads. For an example, refer to Example – Stripping Layer 3 GRE IP Encapsulated Packets.</p> <p>Layer 2 – The GigaSMART can strip GRE MPLS encapsulated and GRE Ethernet encapsulated packets, as follows:</p> <ul style="list-style-type: none"> GRE MPLS encapsulation – strip outer Ethernet header, outer IP header, GRE header, and MPLS header. GRE Ethernet encapsulation (Transparent Ethernet Bridging) – strip outer Ethernet header, outer IP header, and GRE header. For an example, refer to Example – Stripping Layer 2 GRE Ethernet Encapsulated Packets.
Maximum MPLS Label Stack	The GigaSMART can strip MPLS headers up to a depth of seven labels.
Supported VLAN Types	The GigaSMART can strip both 802.1Q and Q-in-Q VLAN headers. Refer to How to Handle Q-in-Q Packets in Maps .
VXLAN Stripping	<p>GigaSMART can strip VXLAN (Virtual eXtensible Local Area Network) headers. You can strip either matching VXLAN headers or all VXLAN headers. Select Strip Header from the GigaSMART Operation, select VXLAN for the protocol and use the following value in the Vxlan Id field: 0~(2²⁴-1).</p> <p>The VXLAN header is 8 bytes long with a 3-byte VXLAN Network Identifier (VNI) field. The VNI field is matched with the configured value and if it matches, the outer header (L2+IP+UDP+VXLAN) is stripped and the inner frame is sent to the tool.</p>

Summary	Description
	<p>Specify a value of 0 to strip all outer VXLAN headers.</p> <div style="border: 1px solid #ccc; padding: 5px; margin-top: 10px;"> <p>NOTE: When processing packets with multiple encapsulation layers – for example, an ERSPAN-tunneled packet with a VXLAN tag – a VXLAN header-stripping operation will strip all the way to the end of the VXLAN layer instead of just the VXLAN tag.</p> </div>
ISL Tunnel Stripping	<p>ISL tunnel stripping removes the 26-byte header and the 4-byte FCS trailer associated with Cisco ISL VLAN encapsulation.</p> <p>IMPORTANT: Make sure the packets processed by a GigaSMART operation with a Strip Header ISL component are all using ISL encapsulation. GigaSMART operations do not distinguish between packets using ISL and packets that do not – it strips the requisite bytes from all packets it processes.</p>
GTP Tunnel Stripping	<p>GTP tunnel stripping removes the header and trailer for GTP-u packets inside the GTP tunnel between the SGSN and GGSN interfaces in a 3G network, and between the eNodeB (eNb) and the SGW and between the SGW and the PGW in an LTE network.</p> <p>The SGSN and GGSN interfaces are also referred to as the Gn (or Gp) interface.</p> <p>The interface between eNb and SGW is referred to as S1U. The user plane interface between SGW and PGW is referred to as S5-U/S8-U. Both use GTPv1.</p> <p>Both GTPv1 and GTPv0 are supported for stripping. GTP-c control packets are not stripped. GTP¹ (also referred to as “GTP-Prime”) is not supported for stripping.</p>
Ethertype Replaced	<p>After the VLAN/MPLS headers are stripped, the original ethertype carried in the Layer Two header is no longer valid. The GigaSMART replaces the ethertype field differently for MPLS and VLAN packets:</p> <p>Ethertype Replacement for VLAN Packets</p> <p>VLAN-tagged packets carry the original value for the ethertype field immediately after the VLAN tag. After the four-byte VLAN header is stripped, GigaSMART simply sets the ethertype field in the Layer 2 header to the value that was originally present in the packet past the VLAN tag.</p> <p>Ethertype Replacement for MPLS Packets</p> <p>Unlike VLAN-tagged packets, the Layer 3 protocol type is not carried in the packet for an MPLS packet – instead, it is applied by an egress router. To handle this, the GigaSMART examines the byte following the MPLS header to determine whether the packet is IPv4/IPv6 and takes the following actions:</p> <ul style="list-style-type: none"> • IPv4 – The GigaSMART replaces the ethertype from the MPLS packet with the IPv4 ethertype (0x0800) • IPv6 – The GigaSMART replaces the ethertype from the MPLS packet with the IPv6 Ethertype (0x86DD). • Non-IPv4/IPv6 – The GigaSMART passes the packet to destination tool ports without stripping the header. MPLS header stripping is only supported for IPv4/IPv6 packets.
CRCs Recalculated	The GigaVUE H Series node automatically recalculates and applies correct CRC checksums

Summary	Description
	based on the new packet length after the header is stripped.
Viewing Statistics	From the device view, select GigaSMART > GigaSMART Operations (GSOPS) > Statistics to see statistics related to ongoing header stripping operations. Refer to View GigaSMART Statistics for more information.
Combine with Other Components	You can combine the Strip Header component with other GigaSMART components in a single operation. Refer to How to Combine GigaSMART Operations for details on the combinations of GigaSMART operations. Refer to Order of GigaSMART Operations for information on the order in which components of a single GigaSMART operation are applied.
GigaSMART Engine Ports	Header stripping operations can be assigned to GigaSMART groups consisting of multiple engine ports. Refer to Groups of GigaSMART Engine Ports for details.
Generic	Use Generic Header Stripping to remove any arbitrary header from a packet by specifying the offset and the length of the header. For information about Generic Header Stripping, refer to Generic Header Stripping .

Header Stripping Illustrated

The following figures illustrate how the header-stripping operations work – you can see the original MPLS packet with its label stack intact, followed by a stripped packet with a recalculated CRC and a new ethertype field.



Example – Stripping MPLS Headers and Adding a VLAN ID

The example shown in [Figure 405: Strip Header GigaSMART Operation for Stripping MPLS Headers](#) illustrates a simple GigaSMART operation named **HeaderStrip** configured to strip MPLS headers and add a VLAN tag of 200. The operation is assigned to the GigaSMART group with the alias of gsGrp1.

The screenshot shows a configuration interface for a GigaSMART operation. The 'Alias' field is set to 'HeaderStrip'. The 'GigaSMART Groups' dropdown is set to 'gsGrp1'. The 'GigaSMART Operations (GSOP)' dropdown is empty. Below this, there are two expandable sections: 'Add Header' and 'Strip Header'. The 'Add Header' section is expanded, showing a 'VLAN' field with the value '200'. The 'Strip Header' section is also expanded, showing a dropdown menu with 'MPLS' selected.

Figure 405: Strip Header GigaSMART Operation for Stripping MPLS Headers

The example shown in [Figure 406: Strip Header GigaSMART Operation for Stripping GTP Tunnel Information](#) illustrates a simple GigaSMART header stripping operation named **gtp-strip** configured to strip GTP tunnel information. The operation is performed by the GigaSMART group with the alias of GS1.

The screenshot shows a configuration interface for a GigaSMART operation. The 'Alias' field is set to 'gtp-strip'. The 'GigaSMART Groups' dropdown is set to 'gsGrp1'. The 'GigaSMART Operations (GSOP)' dropdown is empty. Below this, there is one expandable section: 'Strip Header', which is expanded to show a dropdown menu with 'GTP' selected.

Figure 406: Strip Header GigaSMART Operation for Stripping GTP Tunnel Information

Example – Stripping Layer 3 GRE IP Encapsulated Packets

Use the configuration shown in the following figure to strip Layer 3 GRE IP encapsulated packets.

The screenshot shows a configuration interface for a GigaSMART operation. The 'Alias' field is set to 'header-strip-gre'. The 'GigaSMART Groups' dropdown is set to 'gsgrp-1_4_e1'. The 'GigaSMART Operations (GSOP)' dropdown is empty. Below this, there is one expandable section: 'Strip Header', which is expanded to show a dropdown menu with 'GRE' selected.

The following figure shows L3 GRE IP encapsulation before and after stripping.

Before L3 GRE Stripping:

```

Frame 1: 138 bytes on wire (1104 bits), 138 bytes captured (1104 bits)
Ethernet II, Src: c2:00:57:75:00:00 (c2:00:57:75:00:00), Dst: c2:01:57:75:00:00 (c2:01:57:75:00:00)
Internet Protocol Version 4, Src: 10.0.0.1 (10.0.0.1), Dst: 10.0.0.2 (10.0.0.2)
Generic Routing Encapsulation (IP)
  Flags and Version: 0x0000
  Protocol Type: IP (0x0800)
Internet Protocol Version 4, Src: 1.1.1.1 (1.1.1.1), Dst: 2.2.2.2 (2.2.2.2)
Internet Control Message Protocol

```

After L3 GRE Stripping:

```

Frame 1: 114 bytes on wire (912 bits), 114 bytes captured (912 bits) on interface 0
Ethernet II, Src: c2:00:57:75:00:00 (c2:00:57:75:00:00), Dst: c2:01:57:75:00:00 (c2:01:57:75:00:00)
  Destination: c2:01:57:75:00:00 (c2:01:57:75:00:00)
  Source: c2:00:57:75:00:00 (c2:00:57:75:00:00)
  Type: IP (0x0800)
Internet Protocol Version 4, Src: 1.1.1.1 (1.1.1.1), Dst: 2.2.2.2 (2.2.2.2)
Internet Control Message Protocol

```

Example – Stripping Layer 2 GRE Ethernet Encapsulated Packets

Use the configuration shown in the following figure to strip Layer 2 GRE Ethernet encapsulated (Transparent Ethernet Bridging) packets.



The following figure shows L2GRE Ethernet encapsulation before and after stripping.

Before L3 GRE Stripping:

```

Frame 1: 138 bytes on wire (1104 bits), 138 bytes captured (1104 bits)
Ethernet II, Src: c2:00:57:75:00:00 (c2:00:57:75:00:00), Dst: c2:01:57:75:00:00 (c2:01:57:75:00:00)
Internet Protocol Version 4, Src: 10.0.0.1 (10.0.0.1), Dst: 10.0.0.2 (10.0.0.2)
Generic Routing Encapsulation (IP)
  Flags and Version: 0x0000
  Protocol Type: IP (0x0800)
Internet Protocol Version 4, Src: 1.1.1.1 (1.1.1.1), Dst: 2.2.2.2 (2.2.2.2)
Internet Control Message Protocol

```

After L3 GRE Stripping:

```

Frame 1: 114 bytes on wire (912 bits), 114 bytes captured (912 bits) on interface 0
Ethernet II, Src: c2:00:57:75:00:00 (c2:00:57:75:00:00), Dst: c2:01:57:75:00:00 (c2:01:57:75:00:00)
  Destination: c2:01:57:75:00:00 (c2:01:57:75:00:00)
  Source: c2:00:57:75:00:00 (c2:00:57:75:00:00)
  Type: IP (0x0800)
Internet Protocol Version 4, Src: 1.1.1.1 (1.1.1.1), Dst: 2.2.2.2 (2.2.2.2)
Internet Control Message Protocol

```

Display Header Stripping Statistics

To display header stripping statistics, select **GigaSMART > GigaSMART Operations (GSOP) > Statistics**.

Refer to [Header Stripping Statistics Definitions](#) for descriptions of these statistics as well as to [GigaSMART Operations Statistics Definitions](#).

Example – FM6000 Timestamping

[Figure 407: Strip Packets with FM6000 Timestamp](#) shows an example GigaSMART Operation configured to strip packets containing the FM6000 timestamp:

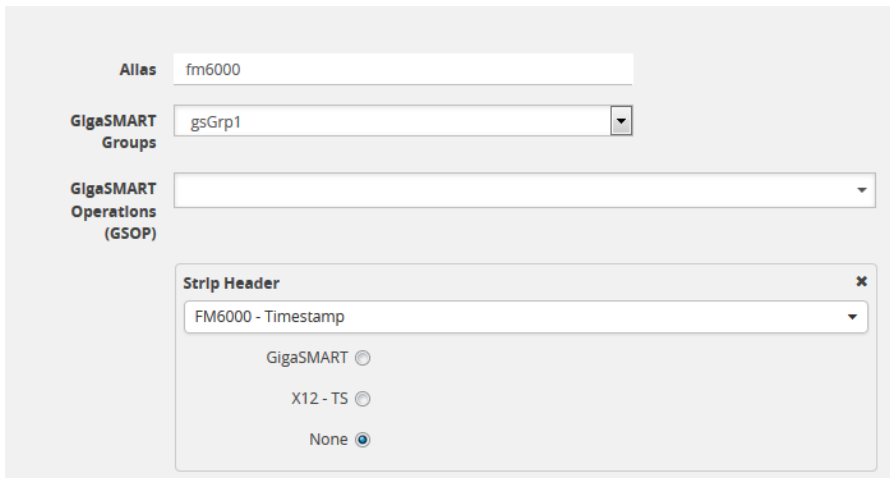


Figure 407: Strip Packets with FM6000 Timestamp

[Figure 429: GigaSMART Operation with a Static Offset](#) is an example GigaSMART Operation configured to convert packets containing the FM6000 timestamp to UTC and append the UTC timestamp to the Gigamon trailer:

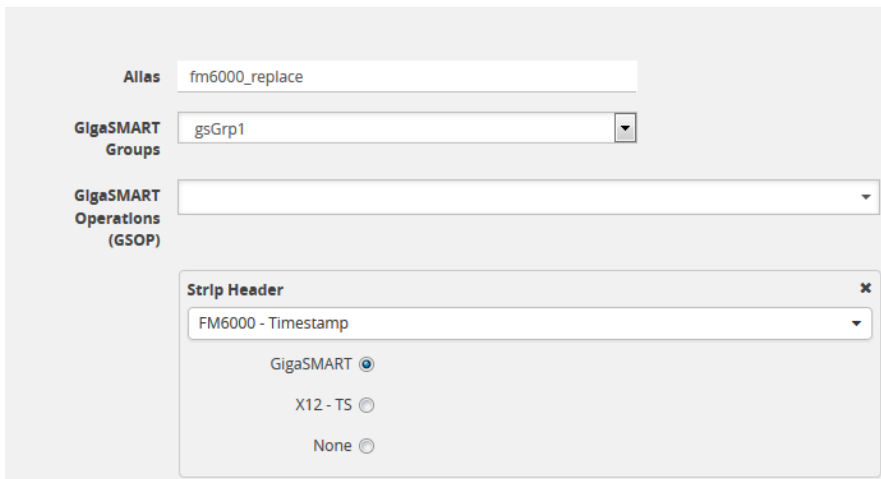


Figure 408: Strip Packets and Append UTC Timestamp to the Gigamon Trailer

Figure 409: Map with Strip Header GigaSMART Operation is an example map using the strip header GigaSMART operation in Figure 408: Strip Packets and Append UTC Timestamp to the Gigamon Trailer.

The screenshot shows a configuration page for a map. It is divided into two main sections: "Map Info" and "Map Source and Destination".

Map Info:

- Map Alias:** fm6000_map
- Comments:** (empty text field)
- Type:** Regular (dropdown menu)
- Subtype:** By Rule (dropdown menu)
- No Rule Matching:** Pass Traffic

Map Source and Destination:

- Port Editor:** (button)
- Source:** 56/1/g5 (dropdown menu)
- Destination:** 56/1/g9 (dropdown menu)
- GigaSMART Operations (GSOP):** fm6000_replace (gsgrp) (dropdown menu)

Figure 409: Map with Strip Header GigaSMART Operation

NOTE: (There is one-to-one mapping between the GigaSMART Operation (gsop) and the map.)

If there are multiple devices, each device can be configured with a different timestamp format. To configure this, use a different gsop and a different map for each device. For example, for packets arriving from FM6000 device1, configure a gsop for FM6000 device1 and associate it with map1. For packets arriving from FM6000 device2, configure a gsop for FM6000 device2 and associate it with map2.

All the maps can send all the packets to the same tool port.

Generic Header Stripping

To access GigaSMART within GigaVUE-FM, access a device that has been added to GigaVUE-FM from the GigaVUE-FM interface. GigaSMART appears in the navigation pane of the device view on supported devices. Refer to [Access GigaSMART from GigaVUE-FM](#) for details.

GigaSMART operations use **Generic** header stripping to remove any arbitrary headers from a packet. The headers are stripped based on the offset and the length of the header.

To perform the generic header stripping operation:

1. Click **GigaSMART** on the left navigation pane. The GigaSMART Operation (GSOP) page is displayed.

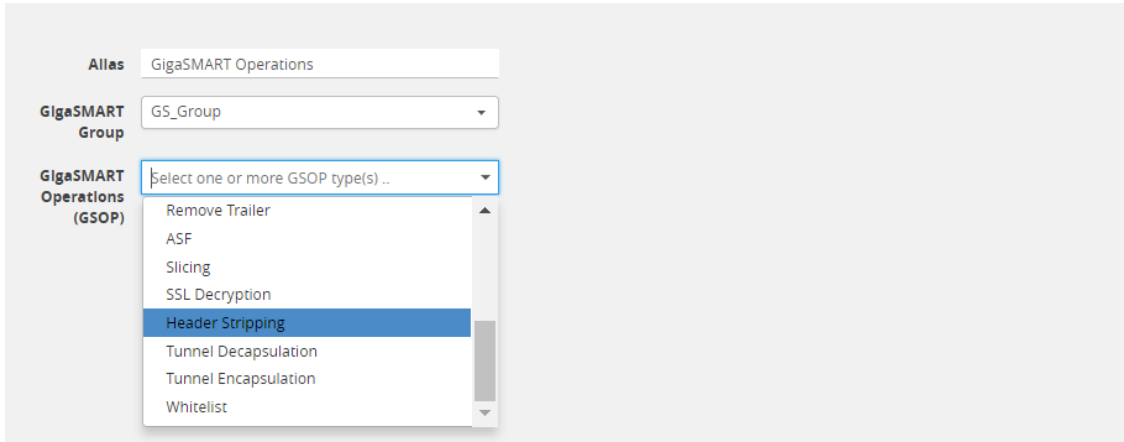


Figure 410: GigaSMART Header Stripping

2. In the **Alias** field, enter a name.
3. From the **GigaSMART group** drop-down list, select a GigaSMART group.
4. From the GigaSMART Operations (GSOP) drop-down list, select **Header Stripping**. A **Header Stripping** drop-down list is displayed.

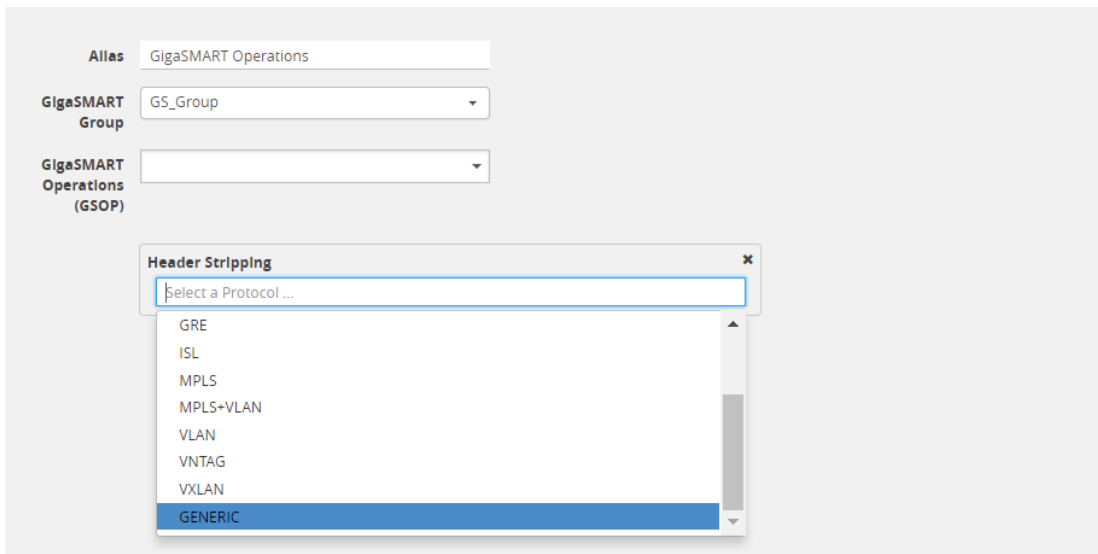


Figure 411: GigaSMART Generic Header Stripping

5. From the **Header Stripping** drop-down list, select **Generic**.

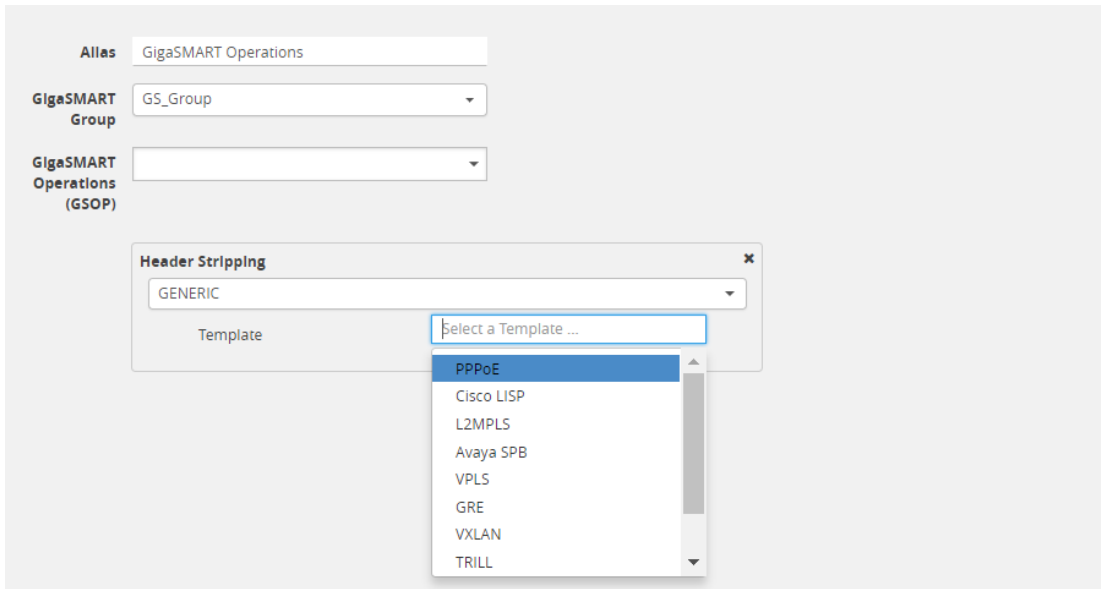


Figure 412: Generic Header Stripping Template

6. From the **Template** drop-down list, select one of the following options:
 - Custom
 - PPPoE
 - Cisco LISP
 - L2MPLS
 - Avaya SPB
 - VPLS
 - GRE
 - VXLAN
 - TRILL
 - Brocade VCS

Custom

A custom template lets you strip any arbitrary headers from a packet.

To strip any arbitrary header from a packet:

1. From the **Template** drop-down list, select **Custom**.

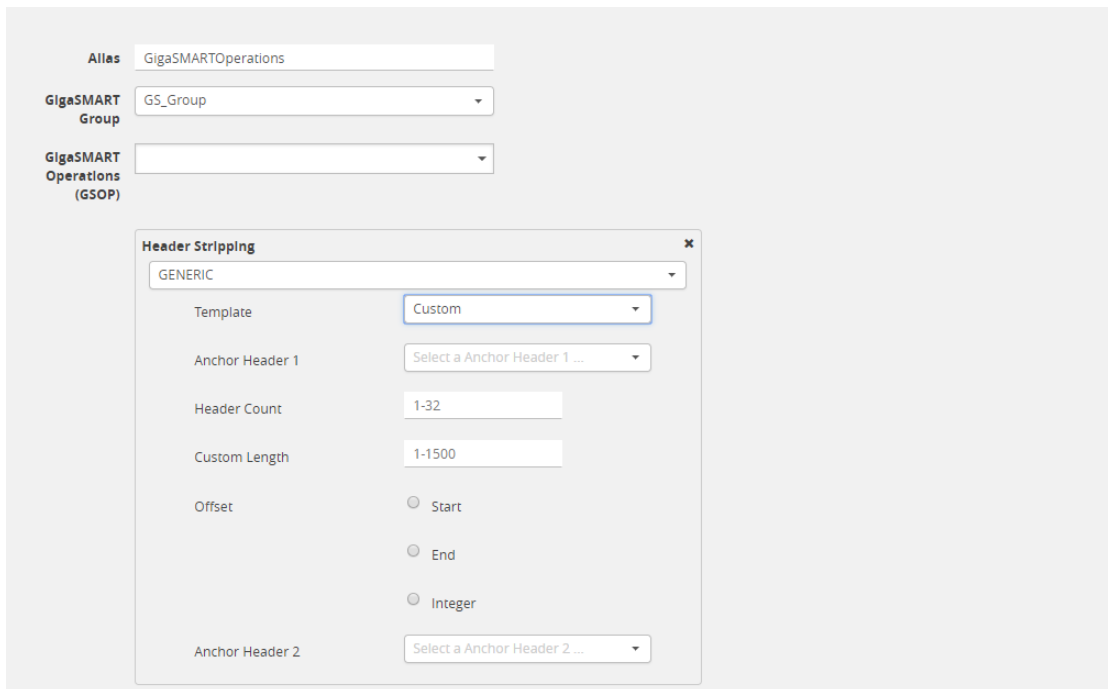


Figure 413: Generic Header Stripping - Custom

2. Select the following options to determine the headers to be stripped:

Component	Description
Anchor Header 1	<p>Specifies the protocol from where GigaSMART should start stripping the header. The following values can be specified:</p> <p>None, Eth, VLAN, MPLS, IPv4, and IPv6</p> <p>The value None starts the header stripping operation from the start of the packet. If None is selected for Anchor Header 1, the Anchor Header 2 must also be set to None. The offset must not be set to end.</p>
Offset	<p>Specifies exactly from which end of Anchor Header 1 the stripping operation should start. You can specify the offset in terms of the following:</p> <p>Start—the header stripping operation starts from the left end of the Anchor Header 1.</p> <p>End—the header stripping operation starts from the right end of the Anchor Header 1.</p> <p>Integer—the header stripping operation starts from the specified integer offset of the Anchor Header 1. The integer value varies depending on the Anchor Header 1 specified.</p>
Header Count	<p>Specifies how many headers from the offset GigaSMART should remove. This is applicable when the packet headers are of known type. The known headers are as follows: Ethernet, VLAN, MPLS, IPv4, and IPv6.</p> <p>It is important to note that, if start is specified for offset, the Anchor Header 1 is already counted for stripping. So, the value specified in the Header Count excludes the Anchor Header 1. If None is specified for Anchor Header 1, the Anchor Header 1 is not counted for stripping. So, the Header Count counts the Anchor Header 1 for stripping operation.</p>
Custom Length	<p>Specifies how many bytes of packet GigaSMART should remove. If the packet headers are</p>

Component	Description
	<p>unknown, the custom length of the unknown header can be specified to strip the packets. A combination of Header Count and Custom Length can also be used to strip the known and unknown headers.</p> <p>If Custom Length is specified, do not select Any for Anchor Header 2.</p>
Anchor Header 2	<p>Specifies the protocol that should become the next header after the stripping operation is complete. The following values can be specified:</p> <p>None, Eth, VLAN, MPLS, IPv4, IPv6, TCP, UDP, and Any</p> <p>The value Any indicates that the next possible header can be any one of the options displayed for Anchor Header 2.</p> <p>The value None indicates that it is not necessary to mention the Anchor Header 2.</p>

NOTE: Generic Header Stripping cannot strip unknown headers with variable length.

PPPoE

The PPPoE template lets you strip the PPPoE encapsulated packets from the packet structure. [Figure 414: PPPoE Encapsulated Packets](#) illustrates a red outline around the frame that needs to be striped.



Figure 414: PPPoE Encapsulated Packets

To strip the PPOE encapsulated packets:

1. From the **Template** drop-down list, select **PPPoE**. Refer to [Figure 415: Generic Header Stripping - PPPoE](#).

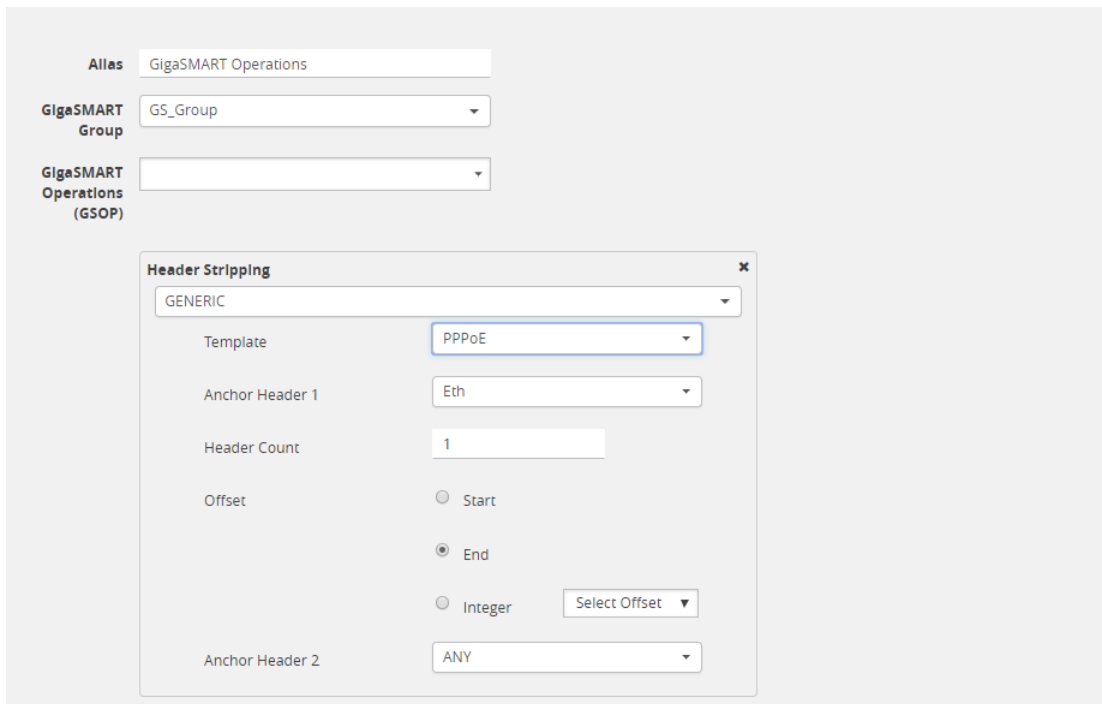


Figure 415: Generic Header Stripping - PPPoE

By default, the following values are selected:

Field	Value	Description
Anchor Header 1 Offset	Eth End	Starts the header stripping operation from the right end of the Ethernet header.
Header Count	1	Strips the header next to the Ethernet Header.
Anchor Header 2	Any	Updates a valid protocol as the Anchor Header 2 in the packet. In this case, any IPv4 or IPv6 protocol can become the Anchor Header 2.

2. Click **OK**. The header stripping operation is displayed in the GigaSMART Operations (GSOP) page.

Cisco LISP

Cisco LISP is used to carry original IP packets to support multi-homing. In this example, the IPv4 outer header, UDP header, and LISP header are stripped from the Cisco LISP header format. The LISP header is considered as an unknown header.

[Figure 416: Cisco LISP Encapsulated Packets](#) illustrates a red outline around the frame that needs to be striped.



Figure 416: Cisco LISP Encapsulated Packets

To strip the Cisco LISP encapsulated packets:

1. From the **Template** drop-down list, select **Cisco LISP**.

Figure 417: Generic Header Stripping - Cisco LISP

By default, the following values are selected:

Field	Value	Description
Anchor Header 1 Offset	Eth End	Starts the header stripping operation from the right end of the Ethernet header.
Header Count	2	Strips the next two headers— IPv4 Outer Header and UDP from the packet.
Custom Length	8	Strips 8 bytes of the unknown packet header. LISP is an unknown header.
Anchor Header 2	IPv4	Updates IPv4 protocol as the Anchor Header 2 in the packet.

2. Click **OK**. The header stripping operation is displayed in the GigaSMART Operations (GSOP) page.

L2 MPLS

The L2 MPLS packet, also known as VPLS, encapsulates Ethernet packets in the MPLS label stack. In this example, the outer Ethernet header and MPLS [PW Label] are stripped from the L2 MPLS encapsulated packets.

Figure 418: L2 MPLS Encapsulated Packets illustrates a red outline around the frame that needs to be stripped.



Figure 418: L2 MPLS Encapsulated Packets

To strip the outer MAC header from the L2 MPLS encapsulated packets:

1. From the **Template** drop-down list, select **L2MPLS**.

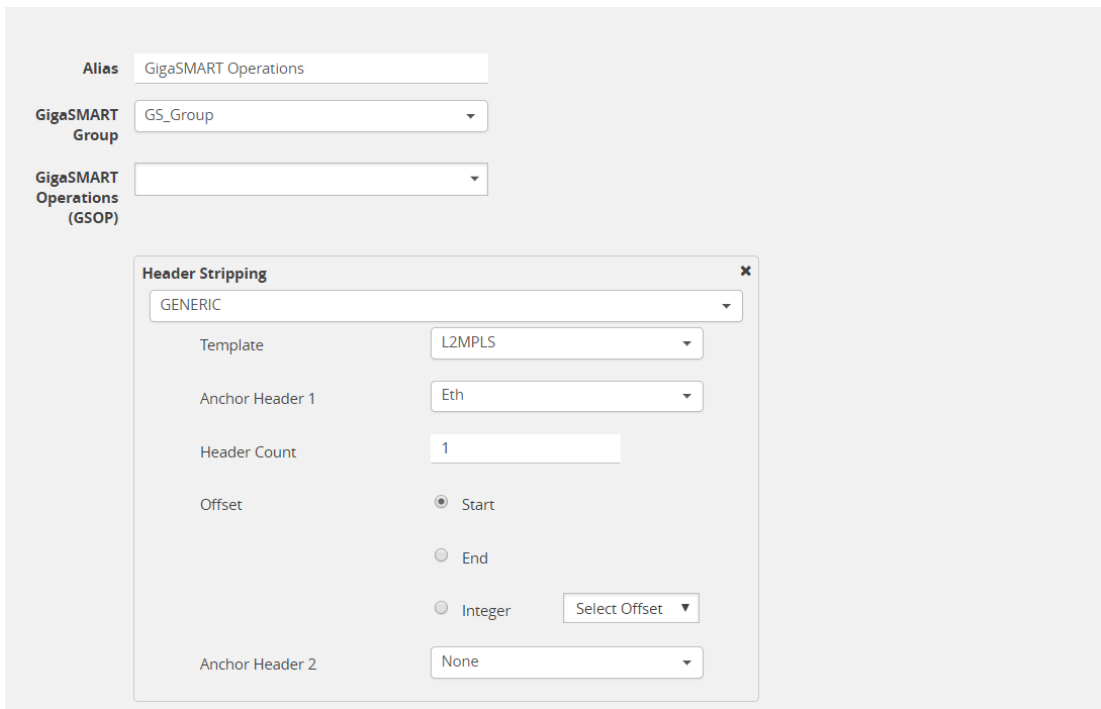


Figure 419: Generic Header Stripping - L2 MPLS

By default, the following values are selected:

Field	Value	Description
Anchor Header 1 Offset	None Start	Starts the header stripping operation from the start of the Ethernet header.

Field	Value	Description
Header Count	2	Strips the first and the second header from the packet. The outer Ethernet header and MPLS [PW label] packet header are both removed. As Anchor Header 1 is set to none, the Header Count counts the first header for stripping.
Anchor Header 2	None	Signifies that there is no need to specify the Anchor Header 2. In this case, the IPv4 protocol forms the first header of the packet after the stripping operation is complete.

2. Click **OK**. The header stripping operation is displayed in the GigaSMART Operations (GSOP) page.

VXLAN

VXLAN encapsulates Ethernet packets in IP using VXLAN header. In this example, the outer Ethernet header, outer IP header, outer UDP header, and VXLAN Header are stripped from the VXLAN encapsulated packets.

[Figure 420: VXLAN Encapsulated Packets](#) illustrates a red outline around the frame that needs to be striped.



Figure 420: VXLAN Encapsulated Packets

To strip the outer Ethernet frame from the VXLAN encapsulated packets:

1. From the **Template** drop-down list, select **VXLAN**.

Figure 421: Generic Header Stripping - VXLAN

By default, the following values are selected:

Field	Value	Description
Anchor Header 1 Offset	Eth Start	Starts the header stripping operation from the start of the Ethernet header.
Header Count	3	Strips the next three headers—outer IP header, outer UDP header, and VXLAN header.
Anchor Header 2	None	Signifies that there is no need to specify the Anchor Header 2. In this case, the IPv4 protocol forms the first header of the packet. NOTE: When the Anchor Header 1 is set to None , the Anchor Header 2 must also be set to None .

2. Click **OK**. The header stripping operation is displayed in the GigaSMART Operations (GSOP) page.

TRILL

TRILL encapsulates Ethernet packets in Ethernet frame to provide L2 layer routing in data centers. In this example, consider TRILL as an unknown header. This TRILL frame is stripped with the inner Ethernet header from the encapsulated packets. The combined length of TRILL header (6 bytes) and

inner Ethernet header (14 bytes) is 20 bytes.

Figure 422: TRILL Encapsulated Packets illustrates a red outline around the frame that needs to be striped.

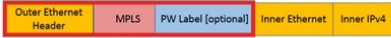


Figure 422: TRILL Encapsulated Packets

To strip TRILL from the encapsulated packets:

1. From the **Template** drop-down list, select **TRILL**.

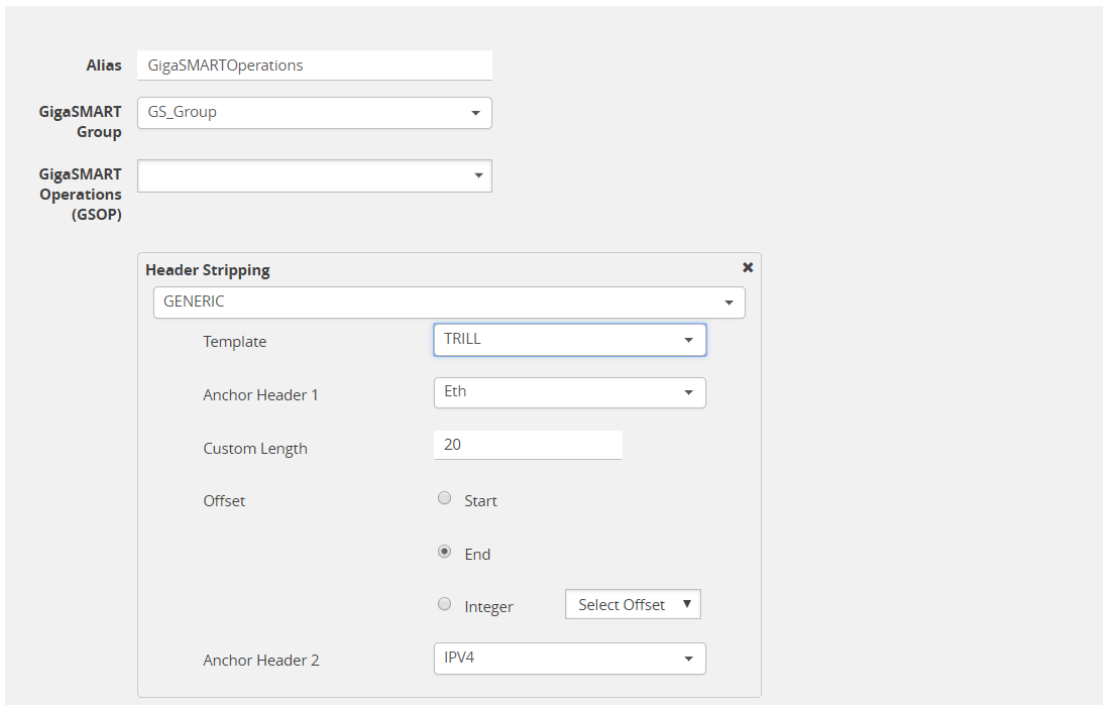


Figure 423: Generic Header Stripping - TRILL

By default, the following values are selected:

Field	Value	Description
Anchor Header 1 Offset	TRILL End	Starts the header stripping operation from the right end of the outer Ethernet header.
Custom Length	20	Strips 20 bytes of unknown header from the packets. In this case, the TRILL and the inner Ethernet headers are stripped.
Anchor Header 2	IPV4	Updates IPV4 protocol as the second header in the packet.

2. Click **OK**. The header stripping operation is displayed in the GigaSMART Operations (GSOP) page.

Avaya SPB

Avaya SPB (802.1ah) fabric encapsulates Ethernet packets using MAC-In-MAC headers. In this example, the outer Ethernet header and ITAG are removed from the packet structure.

Figure 424: Avaya SPB Encapsulated Packets illustrates a red outline around the frame that needs to be striped..



Figure 424: Avaya SPB Encapsulated Packets

To strip the outer Ethernet headers from the Avaya SPB encapsulated packets:

1. From the **Template** drop-down list, select **Avaya SPB**.

Figure 425: Generic Header Stripping - Avaya SPB

By default, the following values are selected:

Field	Value	Description
Anchor Header 1	None	Starts the header stripping operation from the left end of the outer Ethernet header.
Offset	Start	
Header Count	2	Strips the outer Ethernet and ITAG headers from the packet.

Field	Value	Description
Anchor Header 2	None	Signifies that it is not necessary to specify the next header. The inner Ethernet header becomes the first header after the stripping operation is complete.

2. Click **OK**. The header stripping operation is displayed in the GigaSMART Operations (GSOP) page.

You can also strip the ITAG, inner Ethernet header, and VLAN from the packet structure.

Figure 426: Avaya SPB Encapsulated Packets illustrates a red outline around the frame that needs to be striped.

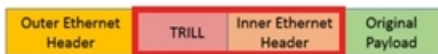


Figure 426: Avaya SPB Encapsulated Packets

To strip the inner Ethernet headers from the encapsulated packets:

1. Select the following values to strip the inner Ethernet headers from the encapsulated packets:

Field	Value	Description
Anchor Header 1 Offset	Eth End	Starts the header stripping operation from the right end of the outer Ethernet header.
Header Count	3	Strips the ITAG, inner Ethernet, and VLAN headers from the packet.
Anchor Header 2	Any	Indicates that any valid protocol available after the header stripping operation can become the next header in the packet.

2. Click **OK**. The header stripping operation is displayed in the GigaSMART Operations (GSOP) page.

GigaSMART Header Addition

Required License: Header Stripping

GigaSMART operations with an **Add Header** selected can add VLAN tags to packets. This operation is useful in the following situations:

- Differentiating stripped packets from non-stripped packets on common IP ranges (for example, 10.x.x.x; 192.168.x.x).

- Removing an arbitrary-length MPLS label stack and replacing it with a single, predictable, four-byte VLAN tag between the source address and ethertype field in the Layer 2 header. Many tools that are unable to parse the arbitrary length of an MPLS label stack can work with a predictable VLAN tag.

Keep in mind the following when configuring GigaSMART operations with an **Add Header** component:

Add VLAN Tag	<p>You can combine Strip Header with VLAN add to help identify packets with stripped headers. This approach lets you remove an arbitrary-length MPLS label stack and replace it with a single, predictable, four-byte VLAN tag between the source address and ethertype field in the Layer 2 header. Many tools that are unable to parse the arbitrary length of an MPLS label stack can work with a predictable VLAN tag.</p> <p>Packet Modifications for add_vlan</p> <p>The Add Header operation makes the following modifications to a packet:</p> <ul style="list-style-type: none"> • TPID – 0x8100 (802.1Q VLAN) or 0x88A8 and 0x9100 (Q-in-Q). The two-byte ethertype originally present in the Ethernet header is moved past the new VLAN header to identify the original Layer 3 header. • CFI – 0 • Priority – 0 • VLAN ID – User-provided value in the VLAN field of an Add Header GigaSMART Operation. <p>Refer to How to Handle Q-in-Q Packets in Maps for TPID.</p>
CRCs Recalculated	The GigaVUE H Series node automatically recalculates and applies correct CRC checksums based on the new packet length after the header is stripped.
Viewing Statistics	Use GS Operations Statistics page to see statistics related to ongoing GigaSMART operations. Refer to View GigaSMART Statistics for more information.
Combine with Other Components	You can combine the Add Header component with other GigaSMART components in a single operation. Refer to How to Combine GigaSMART Operations for details on the combinations of GigaSMART operations. Refer to Order of GigaSMART Operations for information on the order in which components of a single GigaSMART operation are applied.
GigaSMART Engine Ports	Header addition operations can be assigned to GigaSMART groups consisting of multiple engine ports. Refer to Groups of GigaSMART Engine Ports for details.

GigaSMART Masking

Required License: Base

GigaSMART operations with **Masking** selected write over a specific portion of a packet with a specified one-byte pattern. Masking operations consist of an **offset**, **length**, and **pattern** as shown in [Figure 427: GigaSMART Operations Page with Masking Selected](#).

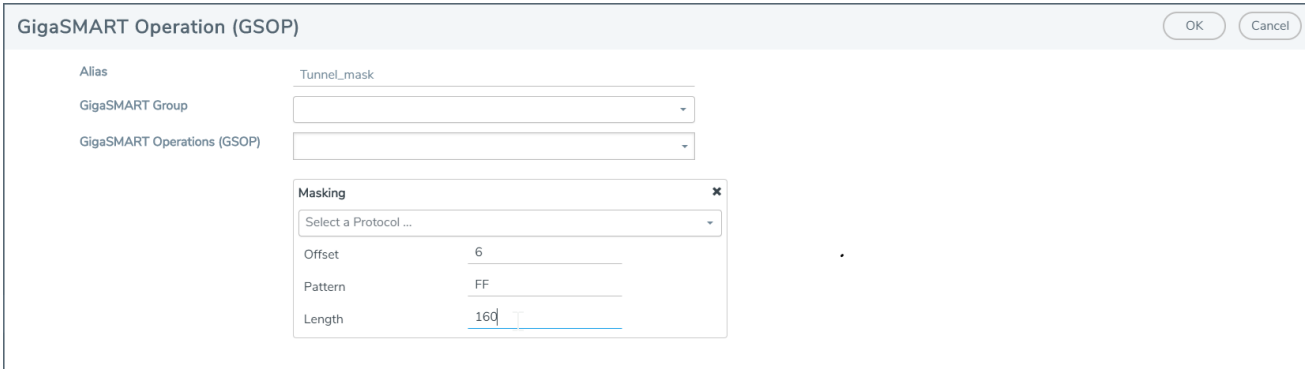


Figure 427: GigaSMART Operations Page with Masking Selected

The following table describes the fields.

Component	Description
Offset	Specifies where GigaSMART should start masking data with the supplied pattern. You can specify this in terms of either a static offset from the start of the packet or a relative offset from a particular protocol layer. This lets you automatically compensate for variable length headers, specifying a mask target in terms of a particular packet header.
Length	Specifies how much of the packet GigaSMART should mask. The specified one-byte pattern can be repeated to mask from 1-9600 bytes.
Pattern	Specifies what pattern GigaSMART should use to mask the specified portion of the packet. You can specify a one-byte hex pattern (for example, 0xFF).

Refer to the following when configuring GigaSMART operations with a **Masking** component:

Feature	Description
Protocol	<p>The following are the protocols that you can select for from the protocol drop-down list:</p> <ul style="list-style-type: none"> • IPV4 – Mask starting a specified number of bytes after the IPv4 header. • IPV6 – Mask starting a specified number of bytes after the IPv6 header. • UDP – Mask starting a specified number of bytes after the UDP header. • TCP – Mask starting a specified number of bytes after the TCP header. • FTP– Identify using TCP port 20. Mask payloads using offset from the TCP header. • https – Identify using TCP port 443. Mask payloads using offset from the TCP header. • SSH – Identify using TCP port 22. Mask payloads using offset from the TCP header. <p>The GigaSMART-HCO module can provide masking for GTP tunnels, provided the user payloads are unencrypted. Both GTPv1 and GTPv2 are supported – GTP' (GTP prime) is not supported. Keep in mind that only GTP-u (user plane packets) are masked. Control plane packets (GTP-c) are left unmodified.</p> <ul style="list-style-type: none"> • GTP – Mask starting a specified number of bytes after the outer GTP header. • GTP-IPV4 – Mask starting a specified number of bytes after the IPv4 header inside

Feature	Description
	<p>the encapsulating GTP packet.</p> <ul style="list-style-type: none"> • GTP-UDP – Mask starting a specified number of bytes after the UDP header inside the encapsulating GTP packet. • GTP-TCP – Mask starting a specified number of bytes after the TCP header inside the encapsulating GTP packet.
Masking Offset and Length	<p>You can specify either a relative offset or a static offset for the masking pattern:</p> <ul style="list-style-type: none"> • Static offsets begin masking a specific number of bytes from the start of the packet. Choose a static offset by setting Protocol to None and supplying an Offset from <0~9000> bytes. Zero (0) indicates the start of the Ethernet frame. • Relative offsets begin masking a specified number of bytes from the end of a particular header – IPv4, IPv6, and so on. Choose a relative offset by selecting any of the following values for the protocol argument and supplying an offset from the specified protocol header of <1~9000> bytes: <div data-bbox="488 898 1455 957" style="border: 1px solid #ccc; padding: 5px; margin-top: 10px;"> <p>NOTE: You can only mask one contiguous portion of a packet.</p> </div>
Recalculated CRC	GigaSMART automatically calculates a new Ethernet CRC based on the masked packet's length and data, and uses it to replace the existing CRC. This way, analysis tools do not report CRC errors for masked packets.
GigaSMART Trailer	Masking operations can optionally include the GigaSMART Trailer. If you do elect to include the GigaSMART Trailer, it will include the original packet length. Refer to GigaSMART Trailer Reference for details.
In Combination with Slicing	Masking operations can be assigned to GigaSMART groups consisting of multiple engine ports. Refer to Groups of GigaSMART Engine Ports for details.

Examples – GigaSMART Masking

The example shown in [Figure 428: GigaSMART Masking Operation](#) creates a GigaSMART masking operation named **Tunnel_mask**. This example starts masking six bytes after the end of the TCP layer in the GTP-encapsulated packet and continues for 150 bytes, writing over the existing data with an FF pattern.

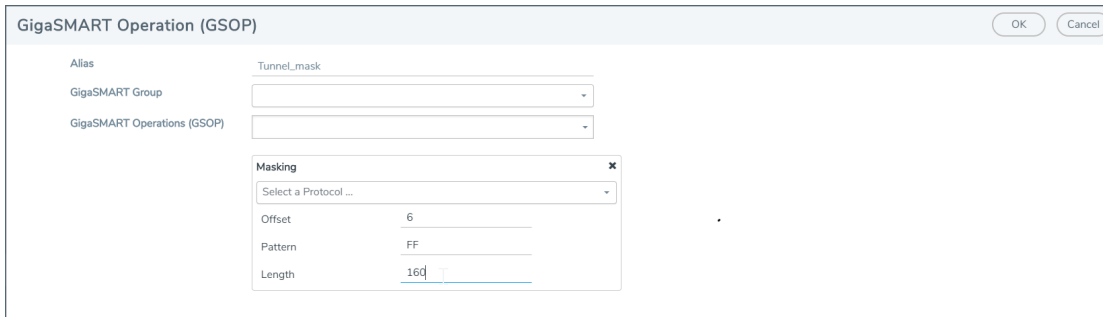


Figure 428: GigaSMART Masking Operation

This example shown in [Figure 429: GigaSMART Operation with a Static Offset](#) creates a GigaSMART masking operation named **Mask_FIX**. This example uses a static masking offset of 148 bytes and continues for the next 81 bytes, writing over the existing data with an **FF** pattern. This GigaSMART operation is assigned to the GigaSMART group with the alias of gs2port2.

This example simulates how to mask a FIX (Financial Information eXchange) packet so that generic information is preserved at the start and end of the FIX data portion of the packet while private information within is masked. This example does not include the optional GigaSMART Trailer.

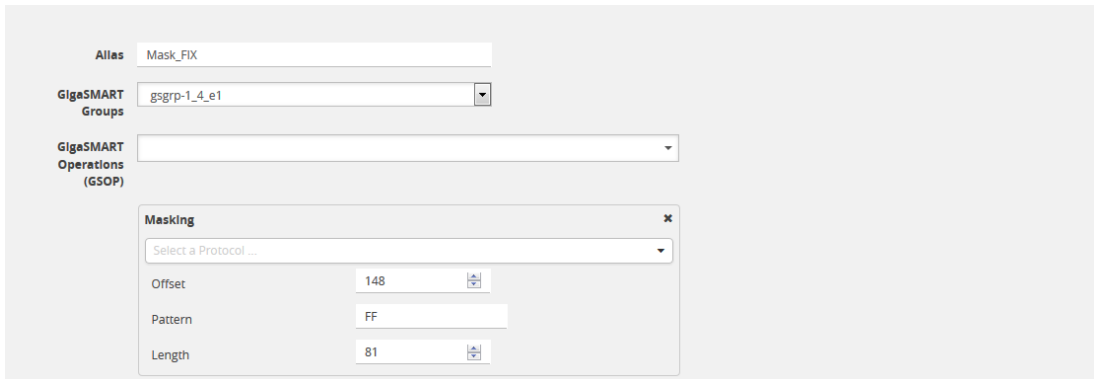


Figure 429: GigaSMART Operation with a Static Offset

Display Masking Statistics

To display masking statistics, select **GigaSMART > GigaSMART Operations (GSOP) > Statistics**. The statistics for masking will be in the row labeled Masking in the GS Operations column.

Refer to [Masking Statistics Definitions](#) for descriptions of the masking statistics as well as to [GigaSMART Operations Statistics Definitions](#).

GigaSMART NetFlow Generation

Required License: NetFlow Generation

Required License for NetFlow with Second Level Maps: Adaptive Packet Filtering (APF)

NetFlow Generation is a simple and effective way to increase visibility into traffic flows and usage patterns across systems. The flow-generated data can be used to build relationships and usage patterns between nodes on the network. Routers and switches that support NetFlow can collect IP traffic statistics to be exported as NetFlow records.

However, the processor and memory load of enabling NetFlow can cause service degradation and affect their ability to pass traffic without introducing latency and packet drops. Due to this processing overhead, sampled NetFlow is implemented in most of the high-end routers. Sampling in every "N" packets for NetFlow processing can severely limit the visibility needed to monitor flows.

The advanced capabilities of GigaSMART[®] technology can be leveraged to summarize and generate unsampled NetFlow statistics from incoming traffic streams. Offloading NetFlow Generation to an out-of-band solution like the Gigamon Visibility Platform completely eliminates the risk of using core production network resources in generating this data. Combined with the flexibility offered by Gigamon's patented Flow Mapping[®] technology, operators can pick and choose from which flows to generate NetFlow statistics, while at the same time sending the original packets to other monitoring tools.

Support for NetFlow versions 5 and 9 and IP Information Export (IPFIX), as well as CEF, enables seamless integration with standards-based collectors. NetFlow records can also be exported to multiple collectors concurrently, providing a single flow source for business-critical management applications such as security, billing, and capacity planning. Exported flows can also be filtered so that collectors only receive the specific records relevant to them.

Gigamon has also extended IPFIX to include URL information, providing insight into HTTP and SIP traffic. Other enterprise extensions for IPFIX are HTTP, DNS, and SSL certificates, which provide metadata that can be used for security analysis.

Additionally, Gigamon's Visibility Platform architecture is the first in the industry to summarize flow statistics as well as to provide the flexibility of aggregating, replicating, filtering, and forwarding raw traffic streams to monitoring tools for detailed troubleshooting and analytics.

The Gigamon Visibility Platform establishes a scalable framework to deliver pervasive flow-level visibility across enterprises, data centers, and service provider environments to accurately design, engineer, optimize, and manage their network infrastructure.

NOTE: NetFlow Generation exports records using IPv4. IPv6 is not supported.

GigaSMART operations with a NetFlow component can be assigned to multiple GigaSMART groups or GigaSMART groups consisting of multiple GigaSMART engine ports.

NetFlow/IPFIX Generation is a pillar of the GigaSECURE Security Delivery Platform.

NetFlow Generation is displayed in [Figure 430: NetFlow Generation Gigamon Solution](#).

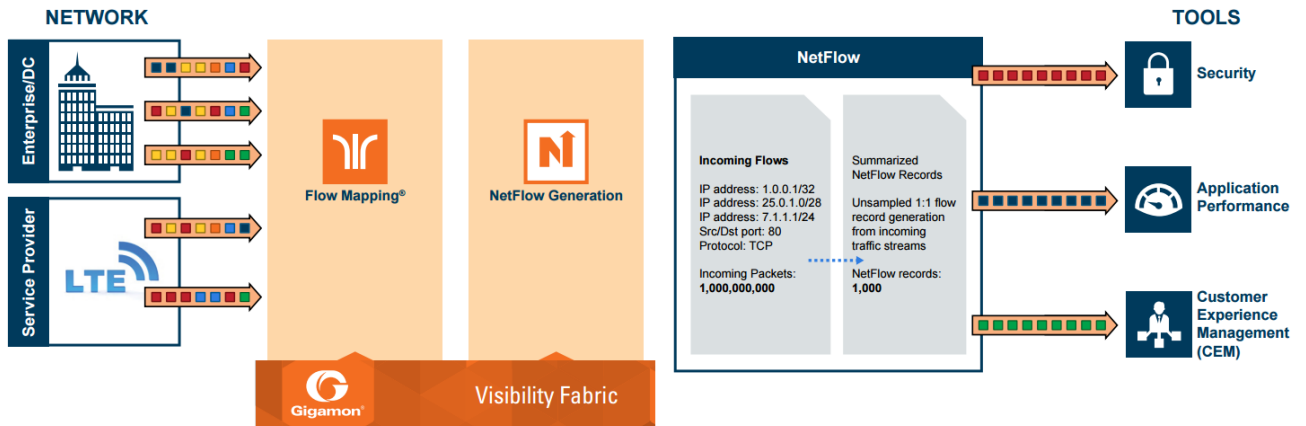


Figure 430: NetFlow Generation Gigamon Solution

In [Figure 430: NetFlow Generation Gigamon Solution](#), incoming packets from network(s) enter the Gigamon Visibility Platform and are directed by maps to NetFlow. NetFlow examines the incoming packets and converts the packets of choice into flows records. Specific flows are then forwarded to specific tools, such as Security, Application Performance, and Customer Experience Management (CEM) tools.

NetFlow Generation Components

NetFlow Generation collects IP traffic statistics on all interfaces where a NetFlow Monitor is enabled. It then gathers the statistics of the traffic flows and exports the NetFlow records to at least one NetFlow collector (typically a device that performs the actual traffic analysis based on the information from the NetFlow records).

[Figure 431: NetFlow Generation Components](#) shows the NetFlow Generation components.

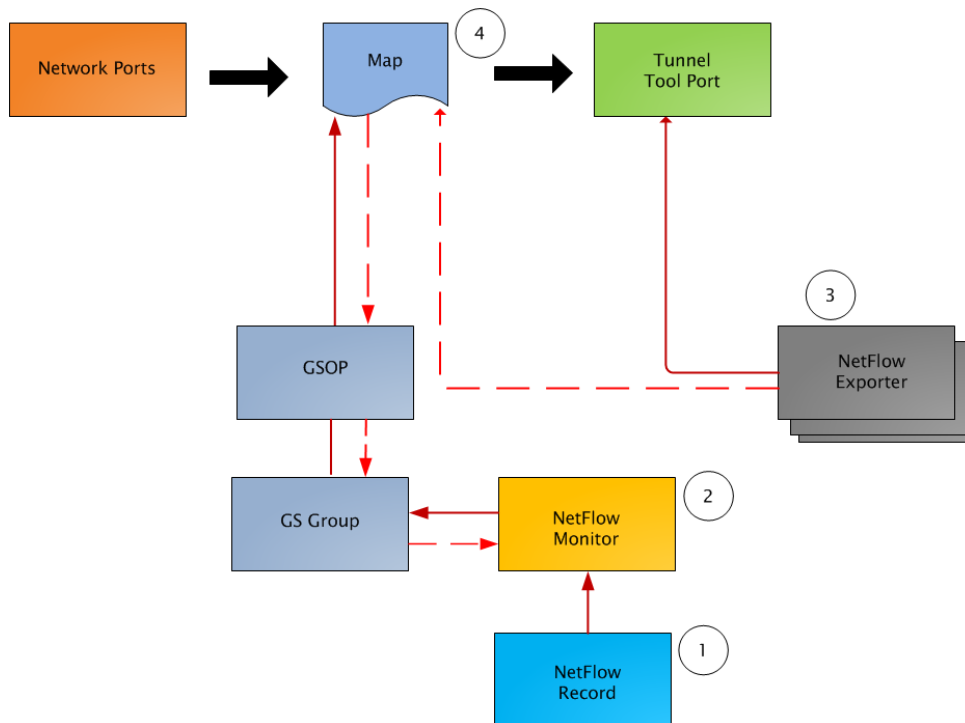


Figure 431: NetFlow Generation Components

GigaSMART NetFlow Generation illustrates the NetFlow Generation and how its components are associated. The NetFlow Generation associates its components in the following order:

1. One or more Records are associated to the Monitor.
2. The Monitor is associated to the GigaSMART group.
3. The Exporter is associated to the IP interface with tool port.
4. The map will eventually bind to the Exporter, Record, and Monitor.

NOTE: The dotted line from the map represents the interaction between the NetFlow Generation components.

Refer to [Example 1: NetFlow Generation Configuration](#) on page 631 for an example configuration of the following components.

Network Ports

NetFlow operates on the network flow. The incoming traffic on the network ports contains inputs such as, source and destination IP addresses, source and destination ports, interfaces, and so on. The network ports provide traffic to maps.

Map(s)

Traffic is received and acted upon according to maps. Maps determine what traffic is forwarded to NetFlow. Through map configuration, you add rules to filter the packets that need to go to NetFlow, and associate the map to the IP interface with tool port to specify where to send the filtered traffic.

Starting in software version 4.3.01, NetFlow supports both first level and second level maps. First level maps contain flow mapping rules to filter traffic that is needed by NetFlow and then send the filtered traffic to the IP interface with tool ports.

Second level maps are used for configuring filtering rules enabled through Adaptive Packet Filtering (APF). A virtual port is configured that directs traffic to the second level map. After the APF rules are applied, the filtered traffic that is needed by NetFlow is sent to the IP interface tool ports.

For examples of first level maps, refer to [Example 1: NetFlow Generation Configuration](#) and [Example 2: NetFlow Generation Configuration](#).

For examples of first and second level maps, refer to [Example 3: NetFlow Generation Configuration](#) and [Example 4: NetFlow Generation Configuration](#).

GigaSMART Group

The GigaSMART group specifies the GigaSMART engine to use, such as 8/1/e1 or 8/1/e2.

GSOP

The GigaSMART operation enables NetFlow. If a second level map is configured, the GigaSMART operation directs traffic to APF first, and then to NetFlow.

NetFlow Records

A NetFlow record contains key elements that specify what to match in the flow, such as all packets with the same source and destination port, or anything that comes in on a particular interface. A flow record also contains non-key elements that specify what information to collect for the flow, such as when the flow started or the number of bytes in the flow.

For NetFlow-v5, the fields in the flow record are fixed. For details, refer to [V5 Fixed Record Template on page 657](#).

For NetFlow-v9 and IPFIX, you configure the fields, and thus create a record template. You specify how the fields are organized and in what order. The template is sent to the collector, so the collector knows what fields to expect in a NetFlow record. The template is sent periodically.

Starting in software version 4.6, multiple records are supported. An increased number of records allows more NetFlow data to be exported.

The maximum number of records is five. For all five records, each record must have the same match fields but differing collect fields. The same match fields will define the flows being considered. The different collect fields will define multiple templates sent to the NetFlow servers.

Starting in software version 5.1 for IPFIX and software version 5.2 for v5 and v9, a mix of IPv4 and IPv6 collect fields (IPv4 source/destination and IPv6 source/destination) are not supported in one record. Instead, create two records, one for IPv4 collect fields and one for IPv6 collect fields. When the IPv4/IPv6 collect fields are in separate records, an exporter will only send out records with non-blank elements.

NetFlow Monitors

Monitors store the NetFlow records associated with them. The configuration of a monitor includes the definition of the cache that specifies the records that you want to store, as well as timeouts associated with the cache. The cache can contain up to 4 million entries.

There can be a maximum of two monitors on a GigaSMART line card or module, one associated with each **e** port.

Starting in software version 4.6, up to five records can be added to the monitor. This results in the creation of five templates. For all five records, each record must have the same match fields but differing collect fields.

Sampled NetFlow Data

NetFlow data can be sampled. Sampling reduces the amount of ingress traffic sent to NetFlow for processing, which reduces the load on external collectors.

A NetFlow monitor can have multiple records with different sampling rates. The records are only updated with packets at the rate specified.

The following types of sampling are available: single-rate or multi-rate, as well as no sampling.

Sampling is enabled and disabled on the NetFlow monitor, across all flows. When sampling is enabled, you define the sampling rate by specifying a number for 1 in N, where N is the packet count.

For single-rate, the number can be from 10 to 16000. For multi-rate, the number can be from 1 to 16000. Single-rate applies to all records, whereas multi-rate applies to any record.

NOTE: In a single-rate sampling type, all the NetFlow records are sampled in the same rate. In multi-rate sampling type, the sampling rate of the NetFlow records differ according to the settings defined in the individual records.

For example, if sampling is 1 in 1024, 1 packet in 1024 will be selected for NetFlow. The default is 1 in 1, which means no sampling.

NetFlow Exporters

NetFlow records are sent to exporters. Each exporter is associated with one external collector. Records can be exported to both IPv4 and IPv6 destination. Either IPv4 or IPv6 destination address can be configured in an exporter. There can be up to six exporters that send flow records to up to six external collectors. The six destinations are per GigaSMART engine.

The configuration of an exporter includes the IP address of a collector, the transport protocol and destination port, and the template refresh interval, which specifies the frequency of when the record template is sent to the collector.

Starting in software version 5.1, an option is added to assign different exporters to different records. Instead of records being sent to all exporters, you can add an exporter to a record, which defines the exporter to which the record is sent.

IP Interface with Tool Ports

NetFlow exporters are associated with IP interface, since exporters route both records and templates to collectors in the network.

NOTE: It is expected that the gateway specified in the IP interface configuration does Layer 3 routing. However, when the IP interface and the collector's IP address are in the same subnet, the following applies:

- Configure the IP interface's gateway IP address to the same as the collector's IP address.
- Configure the IP interface's subnet mask.
- The maximum number of exporters supported per GigaSMART group is six.

Enhancements to NetFlow

In addition to the NetFlow components, there are also the following enhancements:

- [Exporter Filtering](#)
- [Remote Interface IDs](#)
- [NetFlow Option Templates](#)

- *IPFIX Extension: HTTP Response Code*
- *IPFIX Extension: Packet URL*
- *IPFIX Extension: User Agent*
- *IPFIX Extension: Domain Name Service (DNS)*
- *IPFIX Extension: SSL Metadata*
- *SNMP Packet Support on IP Interfaces with Tool Ports*
- *NetFlow Format Support on Exporters*

Exporter Filtering

Not all collectors are interested in all kinds of packets. On each exporter, you can configure pass filters to filter the records transmitted to a collector. Thus, you can send a subset of records to a collector, such as the flow records for UDP packets or for packets coming in on a particular port.

Filtering is based on criteria, such as ports or IP addresses. For example, you can filter on different interfaces, such as single port (1/1/x1) or a contiguous range of ports (1/1/x1..x4). Note that you can only filter the criteria or a subset of the criteria that you configured for the match fields in the record.

NOTE: If no filters are configured, all records are sent to the collectors.

The exporter pass filters are as follows:

- Input interface
- IPv4 and IPv6 DiffServ Code Point (DSCP)
- IPv4 and IPv6 source address
- IPv4 and IPv6 destination address
- IPv4 protocol
- IPv4 Type of Service (TOS)
- IPv6 flow label
- L4 source and destination port
- MAC source and destination address
- VLAN ID

Take into account the following considerations:

- an exporter can have up to 5 filter rules
- each rule can have up to 4 attributes
- input interface can only be specified once per filter

- other attributes can be specified multiple time in a rule
- two rules cannot be identical

For an example of exporter filtering, refer to [Example 2: NetFlow Generation Configuration](#).

Remote Interface IDs

Interface ID, ingress as well as egress, can be configured as match and collect fields. Interface IDs can be local or remote. If you are interested in the interface ID on which a packet arrives, you need the port number of the node sending the packet. To get that information, you can use the LLDP/CDP discovery protocols that talk to neighbors to fetch the remote interface ID.

Discovery has to be either enabled or disabled on all the ports in a map. If discovery is enabled, the remote interface ID is sent in the NetFlow data record, as learned through LLDP/CDP.

To configure port discovery with NetFlow, enable discovery on the port or ports that are specified in the **Source** field of the associated map.

Note the following:

- You cannot modify discovery once the map is defined.
- Local port IDs are unique across a cluster. Remote IDs might not be unique. With port discovery enabled, there is a possibility of port ID collisions.

NOTE: If port discovery is not enabled, the local port ID is sent in the NetFlow data record.

When port discovery is enabled, the sending of the remote ID requires the collaboration of the end nodes. NetFlow expects an integer for port ID. If end nodes send an alphanumeric string, MAC address, or IP address (non-integers), that cannot be translated in an integer, NetFlow interprets them as either 0xFFFF or 0xFFFFFFFF.

When port discovery is enabled and ingress LLDP/CDP packets contain interface IDs that cannot be translated into an integer, use the collect field **interface input name** in the flow record definition. Using an interface name will send meaningful information about a network port to help identify the port to which the flow record refers.

To access GigaSMART within GigaVUE-FM, access a device that has been added to GigaVUE-FM from the GigaVUE-FM interface. **GigaSMART** appears in the navigation pane of the device view on supported devices. Refer to the [Access GigaSMART from GigaVUE-FM](#) for details.

To use the collect field interface input name, do the following:

1. From the device view, select **GigaSMART > NetFlow / IPFIX Generation > Records**.

2. Click **New** to create a new Record or select the record and click Edit to change an existing record.
3. Click in the field **Non-Key Fields (Collect)** and select **Interface** from the list.
4. Select **Input** and then **Input Name**. Specify an input **Width** as shown in [Figure 432: Collect Field Interface input Name](#).
5. Click **Save**.

The image shows a user interface element labeled "Non-Key Fields (Collect)" with a dropdown arrow. Below it, a dialog box titled "Interface" is open. The dialog box contains several options with checkboxes and a text field:

- Input**: checked with a checkbox.
- Input Name**: checked with a checkbox.
- Input Width**: set to the value "32" in a text field with a dropdown arrow.
- Physical**: unchecked with a checkbox.
- Output**: unchecked with a checkbox.

Figure 432: Collect Field Interface input Name

NetFlow Option Templates

For NetFlow-v9 and IPFIX, each exporter periodically sends option templates and option data records. There are two supported option templates, as follows:

- Interface ID to name mapping template and data record
- Exporter statistics template and data record

The option template for interface ID to name mapping contains an interface ID and name pair. Instead of a local port ID, the actual port number is available. For NetFlow-v9, the name field has a fixed length of 32 bytes. Names shorter than 32 bytes will be padded, while names longer than 32 bytes will be truncated. For IPFIX, the name field is of variable length.

NOTE: When port discovery is disabled for the port or ports specified in the **Source** field of the associated map, the interface option data record sends the interface ID to name mapping. But when discovery is enabled, interface option data records are not sent.

Each exporter sends out statistics, based on the standards. The exporter statistics option template includes information such as the exported flow record count, the exported message total count, and the exported octet total count.

By default, the transmission of option templates from the exporter is always enabled. The frequency of the transmission can be configured using the **Template Refresh interval** field in the NetFlow Exporter configuration page. To open the configuration page, select **GigaSMART > NetFlow / IPFIX Generation > Exporters** and click **New**.

IPFIX Extension: HTTP Response Code

For IPFIX only, use the collect field **Private PEN HTTP Response Code** in the flow record definition for capturing any packet with an HTTP response code embedded in it. This is a private information element extension, specific to Gigamon. The only valid private enterprise name (pen) is gigamon.

The HTTP response code information is captured from the packet and reported in the NetFlow record. The captured HTTP response code will be from the first packet that has HTTP/1 at the start of the HTTP header.

The field length in the flow record is a fixed length of 2 bytes. The range of response code values is from 100 to 599, as follows:

- 100-199 (informational)
- 200-299 (success related)
- 300-399 (redirection)
- 400-499 (client requests)
- 500-599 (server related)

If there is no HTTP response code in the flow, a zero value will be reported.

NOTE: In releases prior to software version 5.2, **HTTP Response Code** was directly under **Private PEN**. Starting in software version 5.2, there is a new **HTTP** section with **Response Code** under it. For backwards compatibility, both are supported.

To access GigaSMART within GigaVUE-FM, access a device that has been added to GigaVUE-FM from the GigaVUE-FM interface. **GigaSMART** appears in the navigation pane of the device view on supported devices. Refer to the [Access GigaSMART from GigaVUE-FM](#) for details.

To configure the NetFlow record for capturing any packet with an HTTP response code embedded in it, do the following:

1. From the device view, select **GigaSMART > NetFlow / IPFIX Generation > Records**.
2. Click **New**. Refer to [Figure 433: NetFlow Record Configuration for HTTP Response Code](#).

NetFlow Record Info

Alias: rec1

Description: Description

Export Blank Pen:

Sampling Rate: Disabled: 0, Default: 1, value should be between 0 - 16000

Exporters: No exporters Available..

Version: NetFlow-v9 IPFIX

Configuration

Key Fields (Match): Select a Match Type ..

Non-Key Fields (Collect):

Private [x]

PEN	gigamon
HTTP	
URL	<input type="checkbox"/>
HTTP Response Code	<input checked="" type="checkbox"/>
User Agent	<input type="checkbox"/>
SSL	
DNS	

Figure 433: NetFlow Record Configuration for HTTP Response Code

3. For Version, select **IPFIX**.
4. Click the **Non-Key Fields (Collect)** drop-down list and select **Private**.
5. In the Private non-key field, do the following:
 - Set **PEN** to gigamon. (This is the default.)
 - Select **HTTP Response Code**.
6. Click **Save**.

IPFIX Extension: Packet URL

For IPFIX only, use the collect field **Private PEN HTTP URL** in the flow record definition for capturing any packet with a URL embedded in it. This is a private information element extension, specific to Gigamon. The only valid private enterprise name (pen) is gigamon.

The following URL information is captured from the packet and reported in the NetFlow record:

- HTTP: GET, POST, PUT, DELETE, and HEAD method types
- SIP: INVITE, ACK, BYE, REGISTER, OPTIONS, and CANCEL request types

The captured URL will be from the first packet that contains a URL. If there are additional URLs in subsequent packets in the flow, they will be ignored. If there is no URL in the flow, a zero length will be reported.

NOTE: The URL will always appear as the last element in a template, no matter the order in which the collect fields were configured.

NOTE: In releases prior to software version 5.2, **URL** was directly under **Private PEN**. Starting in software version 5.2, there is a new **HTTP** section with **URL** under it. For backwards compatibility, both are supported.

In [Figure 433: NetFlow Record Configuration for HTTP Response Code](#) in the Private non-key field, select URL and enter an optional width.

IPFIX Extension: User Agent

For IPFIX only, use the collect field **Private PEN HTTP User Agent** in the flow record definition for capturing any packet with a user agent in the HTTP request header to gather information about clients user agents.

In general, the HTTP request is sent from the browser to the web application, so **User Agent** is filled in by the browser. As such, different browsers fill in this field with different values.

The maximum user agent length that is allowed in the data record is 250 bytes. The default is 150 bytes. Use the width parameter to specify a user agent length of up to 250 bytes.

In [Figure 433: NetFlow Record Configuration for HTTP Response Code](#) in the Private non-key field, select User Agent and enter an optional width.

IPFIX Extension: Domain Name Service (DNS)

For IPFIX only, use the non-key or collect field **Private PEN DNS** in the flow record definition for capturing any packet with Domain Name Service (DNS) parameters embedded in it. This is a private information element, specific to Gigamon. The only valid private enterprise name (pen) is gigamon.

A domain name service translates host names into IP addresses. DNS has been exploited by attackers. Use this NetFlow enterprise element to gather metadata to help protect against security threats.

When certain DNS parameters are configured, the corresponding values for those collect parameters can be displayed in hexadecimal format or in text format. The following DNS parameters can display their values as text when the text version of that parameter is used:

- Additional Class, Additional Class Text
- Additional Type, Additional Type Text
- Authority Class, Authority Class Text
- Authority Type, Authority Type Text

- Query Class, Query Class Text
- Query Type, Query Type Text
- Response Class, Response Class Text
- Response IPv4 Address, Response IPv4 Address Text
- Response IPv6 Address, Response IPv6 Address Text
- Response Type, Response Type Text

For example, if the DNS **query-type** parameter collects a hexadecimal value of **0x1**, the **query-type-text** parameter collects the text string A, which refers to the IP address of the host.

The DNS parameters are captured from the packet and reported in the NetFlow record. Refer to [Display Exporter Statistics](#) and [NetFlow Exporter Statistics Definitions](#).

Handle Blank Records for IPFIX

In the NetFlow record, the collect fields may contain one the following:

- Only private enterprise elements such as SSL, HTTP, or DNS
- Only non-private enterprise elements such as source IP address
- Both private and non-private elements

If all the collect fields contain only the private enterprise elements, and if during run-time, the records are blank or empty, they will not be added to NetFlow, however they will be counted in the exporter statistics as Empty Records Not Added.

If the collect fields contain both private and non-private enterprise elements, and if during run-time, the private enterprise elements are blank or empty, the records can be exported to the collector.

Configure DNS Record for IPFIX

To access GigaSMART within GigaVUE-FM, access a device that has been added to GigaVUE-FM from the GigaVUE-FM interface. **GigaSMART** appears in the navigation pane of the device view on supported devices. Refer to the [Access GigaSMART from GigaVUE-FM](#) for details.

To configure the NetFlow record for capturing any packet with (DNS) parameters embedded in it, do the following:

1. Go to **GigaSMART > NetFlow / IPFIX Generation > Records**.
2. Click **New**. Refer to [Figure 434: NetFlow Record Configuration for DNS](#).

NetFlow Record Info

Alias NetFlow Record alias

Description Description

Export Blank Pen

Sampling Rate Isabled: 0, Default: 1, value should be between 0 - 16000

Exporters Select Exporters..

Version NetFlow-v9 IPFIX

Configuration

Key Fields (Match) Select a Match Type ..

Non-Key Fields (Collect)

Private

PEN gigamon

➤ URL

➤ HTTP Response Code

➤ SSL

▼ DNS

DNS

Additional Name	<input type="checkbox"/>
Additional Type	<input type="checkbox"/>
Additional Type Text	<input type="checkbox"/>
Additional Class	<input type="checkbox"/>
Additional Class Text	<input type="checkbox"/>
Additional TTL	<input type="checkbox"/>

Figure 434: NetFlow Record Configuration for DNS

- In the **Alias** field, enter a name.
- To export the blank pen records, select **Export Blank Pen**.
- For Version, select **IPFIX**.
- Click the **Non-Key fields (Collect)** drop-down list and select **Private**.
- In the **PEN** field, enter **gigamon**. (This is the default.)
- Click **DNS** and select the parameters. The Number of Collects field is displayed for some DNS parameters. Refer to [Table 62: DNS Parameters](#) .
- In the **Number of Collects** field, specify the number of instances of elements to collect from the DNS request. The value ranges from 1 to 10. The default value is 1.
- Click **Save**.

Table 62: DNS Parameters

Method	For more information:
Additional Name	The domain name in the additional records section.
Additional Type	The additional type containing one of the RR type code.
Additional Type Text	The text string that corresponds to the hexadecimal value of the additional type containing one of the RR type code.
Additional Class	The additional class containing one of the RR class code.
Additional Class Text	The text string that corresponds to the hexadecimal value of the additional class containing one of the RR class code.
Additional TTL	The time-to-live (TTL), which is the time interval in seconds that the record is cached in the additional records section.
Additional RData	The content that describes the resource in the additional records section.
Additional RData Length	The length of the rdata field in the additional records section.
AN Count	The number of resource records in the answer section.
AR Count	The number of resource records in the additional records section.
Authority Name	The domain name in the authority section.
Authority Type	The authority type containing one of the RR type code.
Authority Type Text	The text string that corresponds to the hexadecimal value of the authority type containing one of the RR type code.
Authority Class	The authority class containing one of the RR class code.
Authority Class Text	The text string that corresponds to the hexadecimal value of the authority class containing one of the RR class code.
Authority TTL	The time-to-live (TTL), which is the time interval in seconds that the record is cached in the authority section.
Authority RData	The content that describes the resource in the authority section. The format of the rdata field varies according to the type and class of the resource record.
Authority RData Length	The length of the rdata field in the authority section.
Bits Count	The variable length of a bit map. The bit map must be a multiple of 8 bits long. For example: "/QR=1/AA=0/TC=0/RD=1/RA=1/AD=0/CD=0/Z=0", where /QR is the query (0) or a response (1), /AA is the authoritative answer, /TC is the truncation, /RD is the

Method	For more information:
	recursion desired, /RA is the recursion available, /AD is the authentic data, /CD is the checking disabled, and /Z is the reserved for future use.
Identifier	The identifier generated by the device that creates the DNS query and is copied by the server into the response so it can be used by that device to match that query to the corresponding reply received from the DNS server.
NS Count	The number of the name server (NS) resource records in the authority records section.
Op Code	The query type.
Qd Count	The number of entries in the question section.
Query Class	The query format containing one of the RR class codes.
Query Class Text	The text string that corresponds to the hexadecimal value of the query format containing one of the RR class codes.
Query Name	The domain name requested in the query. The maximum name length is 64 bytes. If the name is longer, it will be truncated.
Query Type	The query format containing one of the RR type codes.
Query Type Text	The text string that corresponds to the hexadecimal value of the query format containing one of the RR type codes.
Response Code	The type of the response.
Response Class	The response format containing one of the RR class codes.
Response Class Text	The text string that corresponds to the hexadecimal value of the response format containing one of the RR class codes.
Response Name	The domain name in the response. The maximum name length is 64 bytes. If the name is longer, it will be truncated.
Response Type	The query type specified in the response.
Response Type Text	The text string that corresponds to the hexadecimal value of the query type specified in the response.
Response RData Length	The length of the rdata field in the response data field.
Response RData	The content that describes the resource in the response data field. The format of the rdata field varies according to the type and class of the resource record.
Response-TTL	The time-to-live (TTL), which is the time interval in seconds that the record is cached.

Method	For more information:
Response IPv4 Address	The IPv4 address in the response if the response type host and class are Internet/IPv4.
Response IPv4 Address Text	The text string that corresponds to the hexadecimal value of the IPv4 address in the response if the response type host and class are Internet/IPv4. The format is dotted decimal.
Response IPv6 Address	The IPv6 address in the response if the response type host and class are Internet/IPv6.
Response IPv6 Address Text	The text string that corresponds to the hexadecimal value of the IPv6 address in the response if the response type host and class are Internet/IPv6. The format is dotted decimal.

IPFIX Extension: SSL Metadata

For IPFIX only, use the collect field **Private PEN ssl** in the flow record definition for capturing any packet with Secure Sockets Layer (SSL) or server metadata embedded in it, such as common name. This is a private information element extension, specific to Gigamon. The only valid private enterprise name (pen) is gigamon.

Examining the parameters associated with the SSL certificate or the SSL server provides visibility into SSL flows in the network and helps detect malicious activity. For example, checking the issuer might reveal an unknown self-signed certificate or a certificate signed by a questionable Certificate Authority (CA). Checking the certificate validity dates might reveal an expired certificate.

When NetFlow collects SSL certificate metadata, it makes use of the GigaSMART SSL application, described in [GigaSMART Out-of-Band SSL Decryption](#). The data is routed to the SSL application first and then to NetFlow. If de-duplication is also enabled, the data is routed from de-duplication to SSL, and then to NetFlow. The SSL application does not decrypt the data.

NOTE: Only the NetFlow Generation license is needed for NetFlow to collect SSL certificate metadata.

When certain SSL certificate parameters are configured, the corresponding values for those collect parameters can be displayed in hexadecimal format or in text format. The following SSL certificate parameters can display their values as text when the text version of that parameter is used:

- Serial Number, Serial Number Text
- Signature Algorithm, Signature Algorithm Text
- Subject Algorithm, Subject Algorithm Text
- Valid Not After, Valid Not After Text
- Valid Not Before, Valid Not Before Text

To access GigaSMART within GigaVUE-FM, access a device that has been added to GigaVUE-FM from the GigaVUE-FM interface. **GigaSMART** appears in the navigation pane of the device view on supported devices. Refer to the [Access GigaSMART from GigaVUE-FM](#) for details.

To configure a record for SSL Certificate or SSL Server, do the following:

1. From the device view, select **GigaSMART > NetFlow / IPFIX Generation > Records**.
2. Click **New**.
3. For Version, select **IPFIX**.
4. Click in the **Non-Key fields (Collect)** field.
5. Select **Private** from the drop-down list.
6. In the Private non-key field, do the following:
 - Set **PEN** to gigamon.
 - Under SSL, select the SSL Certificate and SSL Server parameters and specify a width value in bytes. For example, **Certificate Issuer Common Name** and **Certificate Subject Common Name** as shown in [Figure 435: NetFlow Record Configuration for SSL](#).

▼ NetFlow Record info

Alias

Description

Export Blank Pen

Sampling Rate

Exporters

Version NetFlow-v9 PFIX

▼ Configuration

Key Fields (Match)

Non-Key Fields (Collect)

Private ✕

PEN

▶ URL

▶ HTTP Response Code

▼ SSL

SSL

Certificate

Certificate Issuer Common Name	<input type="checkbox"/>
Certificate Subject Common Name	<input type="checkbox"/>
Certificate Issuer	<input type="checkbox"/>
Certificate Subject	<input type="checkbox"/>
Certificate Valid Not Before	<input type="checkbox"/>
Certificate Valid Not After	<input type="checkbox"/>
Certificate Serial Number	<input type="checkbox"/>
Certificate Signature Algorithm	<input type="checkbox"/>
Certificate Signature Algorithm Text	<input type="checkbox"/>
Certificate Subject Algorithm	<input type="checkbox"/>
Certificate Subject Algorithm Text	<input type="checkbox"/>
Certificate Subject Key Size	<input type="checkbox"/>
Certificate Subject Alternative Name	<input type="checkbox"/>

Server

Server Name Indication	<input type="checkbox"/>
Server Version	<input type="checkbox"/>
Server Version Text	<input type="checkbox"/>
Server Cipher	<input type="checkbox"/>
Server Cipher Text	<input type="checkbox"/>
Server Compression Method	<input type="checkbox"/>
Server Session ID	<input type="checkbox"/>

▶ DNS

Figure 435: NetFlow Record Configuration for SSL

SSL Certificate Parameters

When certain SSL server parameters are configured, the corresponding values for those collect parameters can be displayed in hexadecimal format or in text format. The following SSL server parameters can display their values as text when the text version of that parameter is used:

- Cipher, Cipher Text

- Version, Version Text

For example, if the **ssl server cipher** parameter collects a hexadecimal value of **C027**, the **ssl server cipher-text** parameter collects the following text string:

```
TLS_ECDH_RSA_WITH_AES_128_GCM_SHA256
```

The parameters supported for the SSL certificate are as follows:

- **Certificate Issuer**—the certificate issuer, which identifies the entity that has signed and issued the certificate. For example: "/C=US/ST=Arizona/L=Scottsdale/O=MyCo2.com, Inc./OU=http://certs.myco2.com/repository//CN=MyCo2 Secure Certificate Authority", where /C is the country name, /ST is the state or province, /L is the locality name, /O is the organization name, /OU is the organizational unit name, and /CN is the common name.
- **Certificate Issuer Common Name**—the certificate issuer common name, which is a subset of **Issuer**.
- **Certificate Subject**—the certificate subject, which identifies the entity associated with the public key stored in the subject public key. The **Certificate Subject** has the same fields as the **Certificate Issuer**.
- **Certificate Subject Common Name**—the certificate subject common name, which is a subset of **Subject**.
- **Certificate Subject Alternative Name**—the subject alternative name, which allows identities to be bound to the subject of the certificate. This parameter is useful to detect if the certificate claims to sign for anything else and to detect anomalies such as certificates that claim to sign for a wildcard (*). The first subject alternative name present in the certificate is collected.
- **Certificate Valid Not Before** and **Certificate Valid Not After**—the date on which the certificate validity period begins and ends. The certificate validity period is the time interval during which the CA warrants that it will maintain information about the status of the certificate. It is expressed in universal time. The format is YYMMDDHHMMSSZ, where Z is Zulu time (GMT).
- **Certificate Valid Not Before Text** and **Certificate Valid Not After Text**—the text string that corresponds to the hexadecimal value of the date on which the certificate validity period begins and ends. The format is MMM DD HH:MM:SS YYYY GMT.
- **Certificate Serial Number**—the unique number for each certificate issued by a given CA. The issuer name and serial number identify a unique certificate. This parameter is useful to detect any certificate changes or substitutions.
- **Certificate Serial Number Text**—the text string that corresponds to the hexadecimal value of the unique number for each certificate issued by a given CA.

- **Certificate Signature Algorithm**—the identifier for the cryptographic algorithm used by the CA to sign the certificate, defined in ASN.1 format. This parameter is useful to detect servers that are not compliant with an organization's cryptographic standards.
- **Certificate Signature Algorithm Text**—the text string that corresponds to the hexadecimal value of the identifier for the cryptographic algorithm used by the CA to sign the certificate, defined in ASN.1 format. This parameter is useful to detect servers that are not compliant with an organization's cryptographic standards.
- **Certificate Subject Algorithm**—the subject public key algorithm used, defined in ASN.1 format, such as RSA or DSA.
- **Certificate Subject Algorithm Text**—The text string that corresponds to the hexadecimal value of the subject public key algorithm used, defined in ASN.1 format, such as RSA or DSA.
- **Certificate Subject Key Size**—the subject public key size.

Optionally, on the **issuer**, **Certificate Issuer Common Name**, **Certificate Subject**, **Certificate Subject Common Name**, and **Certificate Subject Alternative Name** parameters, you can indicate the width of the field in bytes.

SSL Server Parameters

The parameters supported for the SSL server are as follows:

- **Server Name Indication**—the extension to the Transport Layer Security (TLS) protocol by which a client indicates the host name to which it is attempting to connect at the start of the handshaking process.
- **Server Version**—the version of SSL, including the major and minor version.
- **Server Version Text**—the text string that corresponds to the hexadecimal value of the identifier for the version of SSL, including the major and minor version.
- **Server Cipher**—the cipher that the server agreed to use for that session.
- **Server Cipher Text**—the text string that corresponds to the hexadecimal value of the identifier for the cipher that the server agreed to use for that session.
- **Server Compression Method**—the server compression method, which is typically not set (in other words, NULL). This parameter is useful to detect attacks that use compression.
- **Server Session ID**—the session identifier, generated by a server, which identifies a particular session. This parameter is useful to detect a session restart.

Optionally, on the **Server Name Indication** parameter, you can indicated the width of the field in bytes.

Restrict Ports for NetFlow SSL Sessions

SSL metadata is collected by sending all traffic to the SSL module. The SSL module accepts all IPv4 TCP packets and attempts to find SSL sessions. During the process of finding these sessions, the metadata required by NetFlow is extracted.

To improve the throughput of SSL metadata extraction for NetFlow, the TCP ports can be restricted. Reducing the TCP packets inspected by limiting the TCP ports inspected reduces the amount of packets sent to the SSL module.

Configure the monitor to scan specific ports for SSL. Options are available to scan all ports, a list of up to 10 ports, or well-known ports.

The following are the well-known ports:

- MAP_SSL_PORT 993
- POP3_SSL_PORT 995
- SMTP_SSL_PORT 465
- LDAP_SSL_PORT 636
- NNTP_SSL_PORT 563
- HTTP_SSL_PORT 443

Configure SSL Certificate and Server Parameters

To access GigaSMART within GigaVUE-FM, access a device that has been added to GigaVUE-FM from the GigaVUE-FM interface. **GigaSMART** appears in the navigation pane of the device view on supported devices. Refer to the [Access GigaSMART from GigaVUE-FM](#) for details.

To configure the SSL certificate and server parameters to collect, do the following in the UI, for example:

1. From the device view, select **GigaSMART > NetFlow / IPFIX Generation > Records**.
2. Click **New**.
3. Enter an alias in the **Alias** field to identify this record. For example, ipfixrec.
4. Select **IPFIX**.
5. From the **Non-Key Field (Collect)** list, select **Private**.
6. Set **PEN** to gigamon. (This is the default.)
7. Under SSL, select any of the following:
 - Certificate issuer Common Name Width 30
 - Certificate Subject Common Name Width 40

- Certificate issuer Width 150
- Certificate Subject Width 120
- Certificate Valid Not Before
- Certificate Valid Not After
- Certificate Serial Number
- Certificate Signature Algorithm
- Certificate Signature Algorithm Text
- Certificate Subject Algorithm
- Certificate Subject Algorithm Text
- Certificate Subject Key Size
- Certificate Subject Alternative Name
- Server Name Indication Width 64
- Server Version
- Server Version Text
- Server Cipher
- Server Cipher Text
- Server Compression Method
- Server Session ID

8. Click **Save**.

Best Practices for Collecting SSL Metadata

When collecting SSL certificate metadata, the match conditions must be configured so that the NetFlow sessions match the SSL sessions. To do this, configure the following in the NetFlow record for IPv4 flows:

1. From the device view, select **GigaSMART** > NetFlow Record / IPFIX Generation.
2. Select the record ipfixrec and click Edit. (This is the record configured in the previous section [Configure SSL Certificate and Server Parameters](#).)
3. From the **Key Fields (Match)** list, select **IPv4**.
4. Select **Protocol**.
5. Under **Source** select **Address**.
6. Under **Destination** select **Address**.
7. From the **Key Fields (Match)** list, select **Transport** and then select the following:
 - **Source Port**
 - **Destination Port**
8. Click **OK**.

Or, configure the following in the NetFlow record for IPv6 flows:

1. From the device view, select **GigaSMART** > NetFlow Record / IPFIX Generation.
2. Select the record ipfixrec and click Edit. (This is the record configured in the previous section [Configure SSL Certificate and Server Parameters.](#))
3. From the **Key Fields (Match)** list, select **IPv6**.
4. Select **Protocol**.
5. Under **Source** select **Address**.
6. Under **Destination** select **Address**.
7. From the **Key Fields (Match)** list, select **Transport** and then select the following:
 - **Source Port**
 - **Destination Port**
8. Click **OK**.

Or, configure the following in the NetFlow record for a mix of IPv4 and IPv6 flows:

1. From the device view, select **GigaSMART** > NetFlow Record / IPFIX Generation.
2. Select the record ipfixrec and click Edit. (This is the record configured in the previous section [Configure SSL Certificate and Server Parameters.](#))
3. From the **Key Fields (Match)** list, select **IPv4**.
4. Select **Protocol**.
5. Under **Source** select **Address**.
6. Under **Destination** select **Address**.
7. From the **Key Fields (Match)** list, select **IPv6**.
8. Select **Protocol**.
9. Under **Source** select **Address**.
10. Under **Destination** select **Address**.
11. From the **Key Fields (Match)** list, select **Transport** and then select the following:
 - **Source Port**
 - **Destination Port**
12. Click **OK**.

Refer to [NetFlow Statistics Definitions](#) for descriptions of these statistics as well as to [GigaSMART Operations Statistics Definitions](#).

Notes and Considerations for SSL Certificate Metadata

Refer to the following notes and considerations for SSL certificate metadata:

- When the GigaSMART SSL application is gathering SSL certificate metadata for NetFlow, it is not able to decrypt SSL packets at the same time.
- Using the SSL application plus NetFlow to collect SSL certificate metadata consumes GigaSMART resources, resulting in less memory for other GigaSMART applications.
- To retrieve SSL certificate metadata, there must be a valid SSL session in which most of the packets that form the session are received, as follows:
 - For the SSL certificate parameters, all packets up to at least the certificate packet must be received.
 - For the SSL server parameters except **Sever Name Indication**, all packets up to the server hello packet must be received.
 - For the **Server Name Indication** SSL server parameter, all packets up to the client hello packet must be received.

SNMP Packet Support on IP Interfaces with Tool Ports

SNMP packet support on IP interfaces with tool ports processes SNMP packets arriving on IP interfaces with tool ports and forwards them to GigaSMART so that external NetFlow collectors can integrate with GigaSMART NetFlow Generation.

External collectors need to recognize GigaSMART NetFlow Generation as a valid NetFlow interface. The validation can be manual or automatic, as follows:

- with manual validation, configuration on the collector side must provide the details of GigaSMART NetFlow Generation
- with automatic validation, the recipient collector initiates an SNMP query requesting relevant information and GigaSMART NetFlow Generation responds to it with the required information

SNMP packet support on IP interfaces with tool ports provides automatic validation. Starting in software version 4.5, GigaSMART NetFlow Generation processes SNMP packets arriving on IP interfaces with tool ports.

NetFlow records are sent to exporters through IP interfaces with tool ports. Each NetFlow exporter is associated with one external collector. Up to six exporters can send flow records to up to six external collectors.

An IP interface with tool port can have multiple exporters. An external collector can listen to multiple exporters.

To listen to SNMP packets from external collectors, enable SNMP under the NetFlow exporter. The following are the steps to allow external collectors to send SNMP packets to the IP interface with tool port:

1. From the device view, select **GigaSMART > NetFlow > Exporters**.
2. Click **New** to create a new exporter or Edit to configure an existing exporter.
3. Select **SNMP** under the SNMP section.

These steps enables SNMP on the default port, which is port number 161.

NOTE: Only the default SNMP port is supported for packets arriving on the IP interface. If the incoming request uses a non-default SNMP port, they will be dropped at the IP interface.

To disable listening for SNMP packets by a specified NetFlow exporter, uncheck the SNMP check box.

By default, listening to SNMP packets from external collectors is disabled.

NetFlow Format Support on Exporters

NetFlow Exporters support versions IPFIX, v5, and v9. Starting in software version 5.3, the Common Event Format (CEF) version 23 is also supported. CEF is a standard format used by event collection/correlation Security Information and Event Management (SIEM) vendors. SIEMs such as Arcsight, Splunk, and QRadar accept CEF format. By supporting CEF, NetFlow metadata can integrate with and use a variety of SIEMs.

CEF is a logging format that uses the syslog message as a transport mechanism, meaning that the CEF message (header and payload) is included within the syslog message. The transport protocol that is supported is UDP and the default port number is 514.

Metadata that is generated by NetFlow can be exported in the supported formats to one or more collectors. Each exporter must have the same export type (v5, v9, IPFIX, or CEF). One CEF message is sent out per record per flow.

Also, starting in software version 5.3, IP fragmentation is supported. CEF does not allow a message to be split over multiple CEF payloads. Since CEF messages are verbose, they can be larger than the MTU.

To support CEF messages that exceed the MTU, a single IP datagram containing a CEF message will be broken up into multiple packets of smaller sizes. The reassembly of the datagram will occur at the receiving end (at the SIEMs).

For details on the CEF message format, refer to

CEF Message Format

An example of the CEF message format is as follows:

```
Fri Feb 23 02:25:37 2018 9/3/e1  
CEF:23|Gigamon|metadata|5.3.00|4|metadatageneration|6| src=68.94.156.1  
GigamonMdataDnsAdditionalType=41GigamonMdataDnsAdditionalTypeText=OPT
```

In the example CEF message, there is a syslog header, a CEF header, and an extension that contains the CEF payload. The fields are delimited with a vertical bar (|).

The syslog header contains the following:

- timestamp—Fri Feb 23 02:25:37 2018
- host name identifier—9/3/e1

NOTE: The host name identifier has the format <box ID>/<slot ID>/<engine ID>. For example, 9/3/e1 means 9 is the box ID, 3 is the slot ID, and e1 is the engine ID.

The CEF header contains the following:

- version—CEF:23
- device vendor—Gigamon
- device product—metadata
- device version—5.3.00
- signature identifier—4
- name—metadata generation
- severity—6

The CEF extension contains key-value pairs delimited with a space. In the example CEF message, the following is the CEF payload, in plaintext:

- src=68.94.156.1
- GigamonMdataDnsAdditionalType=41
- GigamonMdataDnsAdditionalTypeText=OPT

The CEF standard specifies key-value pairs. There are some predefined standard keys, for example, src is a predefined key for source IP address.

For keys that are not predefined in the CEF standard, such as the NetFlow metadata elements in the CEF extension, there are custom-defined keys. Custom-defined keys have the following format:

- <VendorNameProductNameExplanatoryKeyName>

For example, GigamonMdataDnsAdditionalTypeText, is a custom-defined key that contains the following:

- VendorName—Gigamon
- ProductName—Mdata
- ExplanatoryKeyName—DnsAdditionalTypeText

Another example of the CEF format is the following SSL record:

```
Thu Mar 1 08:21:28 2018 1/1/e1 CEF:23|Gigamon|metadata|5.3.00|4|metadata
generation|6|GigamonMdataSslIssuerName=DigiCert SHA2 High Assurance S
dpt=54839 GigamonMdataSslValidNotBefore=31373031303630303030305a
GigamonMdataSslSerialNo=0118ee3c2167b99e1b718c6eadb8fb4d00000000
GigamonMdataSslValidNotAfter=323030313135313230303030305a
GigamonMdataSslCertSigAlgo=2a864886f70d01010b
GigamonMdataSslCertSubAlgo=2a864886f70d010101
GigamonMdataSslCertSubKeySize=270 GigamonMdataSslServerVersion=771
GigamonMdataSslCertSubAltName=*.stickyadstv.com
GigamonMdataSslServerCompressionMethod=192 GigamonMdataSslServerCipher=49199
GigamonMdataSslServerVersionText=TLSv1.2 GigamonMdataSslServerSessionId=63
GigamonMdataSslIssuer=2f433d55532f4f3d446967694365727420496e632f4f553d7777772
e6469676963
6572742e636f6d2f434e3d446967694365727420534841322048696768204173737572616e636
52053657276 6572204341 GigamonMdataSslCertSubCommonName=*.stickyadstv.com
GigamonMdataSslSub=2f433d55532f53543d4e657720596f726b2f4c3d4e657720596f726b2f
4f3d4672656
```

```
5776865656c204d6564696120496e632f4f553d46726565776865656c2f434e3d2a2e737469636b796164737
4762e636f6d dst=10.50.22.59 src=38.106.34.118 spt=443
```

Configure NetFlow Generation

The following are the step for setting up a typical NetFlow Generation configuration with H-VUE:

- [Step 1: Configure a GigaSMART Group](#)
- [Step 2: Configure the NetFlow Exporter](#)
- [Step 3: Configure an IP Interface](#)
- [Step 4: Configure the NetFlow Record](#)
- [Step 5: Configure the NetFlow Monitor](#)
- [Step 6: Add the NetFlow Monitor to GigaSMART Group](#)
- [Step 7: Configure the GigaSMART Operation](#)
- [Step 8: Configure Mapping Rules to Filter Packets](#)

Step 1: Configure a GigaSMART Group

Configure a GigaSMART Group using the following steps. you will use this GigaSMART Group in [Step 6: Add the NetFlow Monitor to GigaSMART Group](#), where you assign a NetFlow Monitor to the group.

1. From the device view, select **GigaSMART > GigaSMART Groups**.
2. Click **New** to create a new GigaSMART Group or select an existing GigaSMART Group and click **Edit**.
3. Enter an alias to help identify this GigaSMART group. For example, Netflow-gsgrp
4. Select an engine port. (The **e** port references the GigaSMART line card or module.) Your GigaSMART group should look similar to the example shown in the following figure.

The screenshot shows a configuration form for a GigaSMART Group. At the top, there is a dropdown menu labeled 'GigaSMART Group Info'. Below it, there are two input fields: 'Alias' with the value 'NetFlow-gsgrp' and 'Port List' with the value 'E 1/5/e1'.

5. Click **Save**.

Notes:

- To use NetFlow, the GigaSMART Group can only contain one GigaSMART engine port.
- Only one NetFlow Generation Monitor can be configured per GigaSMART Group.

Step 2: Configure the NetFlow Exporter

Configure one or more NetFlow Generation Exporters. There can be up to six NetFlow Generation Exporters for each NetFlow Generation Monitor.

To access GigaSMART within GigaVUE-FM, access a device that has been added to GigaVUE-FM from the GigaVUE-FM interface. **GigaSMART** appears in the navigation pane of the device view on supported devices. Refer to the [Access GigaSMART from GigaVUE-FM](#) for details.

To configure the NetFlow Exporter, do the following:

1. From the device view, select **GigaSMART > NetFlow / IPFIX Generation > Exporters**.
2. Click **New**. The NetFlow Exporters page appears.
3. On the NetFlow Exporter page, enter the information for the exporter. [Table 63: NetFlow Exporter Configuration Fields](#) describes the fields.

NOTE: The NetFlow version must be configured with the same version of the Exporter and the Record. If no version is specified, version 9 is the default.

4. Under the **Filters** section, click **Add a Rule** to create a filter for the exporter.
5. Click **Save**.

Table 63: NetFlow Exporter Configuration Fields

Field	Description
Alias	The alias name for the NetFlow Exporter.
Description	An optional description of the NetFlow record.
Format	The format is either NetFlow or CEF.
Version	The version is either NetFlow-v9, NetFlow-v5, or IPFIX.
Template Refresh Interval	After each template-refresh-interval, the record template is sent to the collector. Also, the option template is sent.
SNMP	Enables SNMP packet support on IP interfaces associated with the NetFlow Exporter.
Transport Protocol	The UDP port of the collector. This value cannot be changed.
IP Version	IP Version of the destination IP. You can select IPv4 or IPv6. Default is set as v4.
Destination IP	The IP address of the NetFlow/IPFIX collector. Default is set as 0.0.0.0.
Destination Port	Port for the destination IP. Default is set as 2055.
DSCP	The DSCP priority of the packet. Default is set as 0.
TTL	The Time to Live of the packet. Default is set as 64.

Step 3: Configure an IP Interface

In this step, you identify the collector port and configure it as a tool port, where the NetFlow collector will be connected, and then configure an IP interface. The steps are as follows:

1. Select the port to use and configure it as a tool port.
 - a. Select **Ports > Ports > All Ports**.
 - b. Click the **Quick Port Editor** button to open the Quick Port Editor.
 - c. In the Quick Port Editor select the port to use for the IP interface, provide an alias to help identify the port (for example, NetFlow_Tunnel_Port), select **Tool** for the port type, and select **Enable**.
 - d. Click **OK**.
2. Select **Ports > IP Interfaces**.

3. Click **New**.
4. On the IP Interface page, do the following:
 - a. In the **Alias** and **Comment** fields, enter a name and description for the IP interface.
 - b. From the **Port** drop-down list, select the tool port that you configured in [Step 1](#).
 - c. Select the type of IP interface as either **IPv4** or **IPv6**.
 - d. Enter the **IP Address**, **IP Mask**, **Gateway** address, and **MTU** value.
 - e. From the **GigaSMART Group** drop-down list, select the GigaSMART group you created in [Step 1: Configure a GigaSMART Group](#).
 - f. From the Exporters drop-down list, select the NetFlow exporter you created in [Step 2: Configure the NetFlow Exporter](#).

Step 4: Configure the NetFlow Record

Configure a NetFlow Generation Record that has the following:

- **match** parameters that identify unique flows
- **collect** parameters that identify fields you want to collect for the unique flows

To access GigaSMART within GigaVUE-FM, access a device that has been added to GigaVUE-FM from the GigaVUE-FM interface. **GigaSMART** appears in the navigation pane of the device view on supported devices. Refer to the [Access GigaSMART from GigaVUE-FM](#) for details.

To configure the NetFlow Record, do the following:

1. From the device view, select **GigaSMART > NetFlow / IPFIX Generation > Records**.
2. Click **New**. The NetFlow record page shown in [Figure 436: NetFlow Record Page](#) displays.

▼ NetFlow Record Info

Alias NetFlow Record alias

Description Description

Export Blank Pen

Sampling Rate Default: 0, value should be between 1 - 16000

Exporters Select Exporters...

Version NetFlow-v9 IPFIX

▼ Configuration

Key Fields (Match) Select a Match Type ..

Non-Key Fields (Collect) Select a Collect Type ..

Figure 436: NetFlow Record Page

3. On the NetFlow Record page, do the following:

a. Specify the NetFlow Record information:

- Enter an **alias** to help identify the record
- Enter a **Description** (optional)
- Enter the **Sampling Rate** that you want
- Select the Exporter that you want from the **Exporters** menu
- Select the **Version**

The **Version** is either **NetFlow-v9** or **IPFIX**. The NetFlow version must be configured with the same version of the Exporter and the Record. **NetFlow-v9** is the default.

The **Sampling Rate** is **multi-rate** only, and is specified as 1 in N, where N is the packet count. The packet count can be a number from 1 to 16000. Refer to [Sampled NetFlow Data](#). The **Sampling Rate** is disabled by default.

NetFlow-v9 and **IPFIX** let you configure Match/Key and Collect/Non-Key elements.

Make sure that you configure the NetFlow version prior to configuring the match and collect parameters because the subsequent parameters depend on the NetFlow version configured.

b. Specify the Configuration:

Key Fields (Match) — the parameters that identify unique flows. The available Match/Key fields are based on the configured NetFlow version

Non-Key Fields (Collect) — the parameters that identify what you want to collect for the unique flows. The number of Collect/Non-Key elements in a record can be up to 32.

For details about the match and collect parameters, refer to [NetFlow Generation Match/Key and Collect/Non-Key Elements](#)

Step 5: Configure the NetFlow Monitor

Configure a NetFlow Generation Monitor and associate the NetFlow Generation Record to the specified NetFlow Generation Monitor by doing the following:

1. From the device view, select **GigaSMART > NetFlow / IPFIX Generation > Monitors**.
2. Click **New**. The Monitors page displays.
3. On the Monitors page, do the following:
 - a. Enter an **Alias** to identify the monitor.
 - b. Enter a **Description** (optional).
 - c. Configure the **Cache** parameters. Refer to [Table 64: NetFlow Monitor Parameters](#).
 - d. Configure the **Sampling** parameters. Refer to [Table 64: NetFlow Monitor Parameters](#).
 - e. Select the **Record** that you configured in [Step 4: Configure the NetFlow Record](#).

4. Click **Save**.

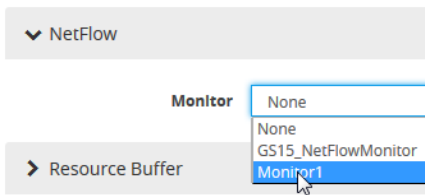
Table 64: NetFlow Monitor Parameters

Parameter	Description
Cache Type	Set as Normal.
Cache Timeout Active	Despite the flow being active, it is “flushed out” to the Exporter after this timeout, which is set in seconds.
Cache Timeout Inactive	Inactive flows are “flushed out” to the Exporter after this timeout, which is set in seconds.
Cache Timeout Event	Applies to the TCP flow. The flow is “flushed out” to the Exporter after detecting a FIN or RST.
Mode	Select the sampling mode that you want: <ul style="list-style-type: none"> • No sampling • Multi rate • Single rate
Single Sampling Rate	Refer to Sampled NetFlow Data .

Step 6: Add the NetFlow Monitor to GigaSMART Group

Return to the GigaSMART Group configured in [Step 1: Configure a GigaSMART Group](#) and set the NetFlow Monitor to the monitor created in [Step 2: Configure the NetFlow Exporter](#).

1. From the device view, select **GigaSMART > GigaSMART Groups > GigaSMART Groups**.
2. Select the GigaSMART Group configured in [Step 1: Configure a GigaSMART Group](#), and then click **Edit**.
3. Under GigaSMART Parameters, go to NetFlow. Click in the **Monitor** field and select the NetFlow monitor configured in [Step 5: Configure the NetFlow Monitor](#) as shown in the following figure.



4. Click **Save**.

Step 7: Configure the GigaSMART Operation

Define a GigaSMART operation to enable NetFlow Generation. If combining NetFlow with APF or Deduplication GSOPs, make sure that you select both operations when creating the GigaSMART Operation.

To access GigaSMART within GigaVUE-FM, access a device that has been added to GigaVUE-FM from the GigaVUE-FM interface. **GigaSMART** appears in the navigation pane of the device view on supported devices. Refer to the [Access GigaSMART from GigaVUE-FM](#) for details.

To configure the GigaSMART Operation, do the following:

1. From the device view, select **GigaSMART > GigaSMART Operations (GSOP)**.
2. Click **New**. The GigaSMART Operations (GSOP) page displays. (Refer to [Figure 437: GigaSMART Operation \(GSOP\) Page](#).)
3. On the GigaSMART Operations page, do the following:
 - a. In the **Alias** field, enter a alias to help identify this gsop.
 - b. In the **GigaSMART Groups** field, select the gsop configured in [Step 1: Configure a GigaSMART Group](#).

aln the **GigaSMART Operations (GSOP)** field, select **NetFlow**. The NetFlow GigaSMART Operation is enabled by default as shown in [Figure 437: GigaSMART Operation \(GSOP\) Page](#).

The screenshot shows the configuration interface for a GigaSMART Operation (GSOP). It includes the following fields and settings:

- Alias:** A text input field containing "NetFlow-gsop".
- GigaSMART Groups:** A dropdown menu with "gsgrp-1_4_e1" selected.
- GigaSMART Operations (GSOP):** A dropdown menu with "NetFlow" selected.
- NetFlow:** A section showing "Enabled" with a checked checkbox and a close button (x).

Figure 437: GigaSMART Operation (GSOP) Page

4. Click **Save**.

Step 8: Configure Mapping Rules to Filter Packets

To add flow mapping rules to filter packets that are needed to run NetFlow, configure a map and associate the map to the IP interface with tool port.

For more detailed information about flow mapping, refer to [About Flow Mapping®](#) and [Manage Maps](#).

Notes:

- For a single NetFlow GigaSMART Operation, make sure that you create a Regular By Rule map. When combining with APF or Deduplication, use First Level or Single Level map types.
- Make sure that the other combining GigaSMART Operations are configured before creating maps using NetFlow.
- When combining NetFlow with APF or Deduplication, create virtual ports to use with the second level maps.
- The destination tool port must be the IP interface with tool port identified in [Step 3: Configure an IP Interface](#)

For second level maps, you will need to create virtual ports. To create virtual ports, do the following:

1. From the device view, select **GigaSMART > Virtual Ports**.
2. Click **New**. The Virtual Ports page displays.
3. Enter an alias in the **Alias** field to identify the virtual port.
4. In the **GigaSMART Groups** field, select the GigaSMART Group configured in [Step 1: Configure a GigaSMART Group](#).
5. Click **Save**.

To configure mapping rules to filter packets, do the following:

1. Select **Maps > Maps > Maps**.
2. Click **New** to create a new map.
3. On the New Map page, do the following:
 - a. Enter an alias in the **Alias** field and select the map **Type** and **Subtype**.
 - b. Specify **Source** and **Destination** ports.
 - c. In the **GigaSMART Operations (GSOP) field**, select the GigaSMART Operation configured in [Step 7: Configure the GigaSMART Operation](#).
 - d. Click **Add a Rule** to add the rules needed for the map.
4. Click **Save**.

Configure NetFlow Generation Examples

The following sections provide examples of NetFlow Generation.

- [Example 1: NetFlow Generation Configuration](#)
- [Example 2: NetFlow Generation Configuration](#)
- [Example 3: NetFlow Generation Configuration](#)
- [Example 4: NetFlow Generation Configuration](#)

Example 1: NetFlow Generation Configuration

In Example 1, the steps set up a typical NetFlow Generation configuration.

Ex 1, Step 1: Configure the GigaSMART Group

Configure a GigaSMART group and associate it with a GigaSMART engine port.

NOTE: To use NetFlow, the gsgroup can only contain one GigaSMART engine port.

Step	Description	UI Steps
1.	Configure the GigaSMART Group	<ul style="list-style-type: none"> a. From the device view, select GigaSMART > GigaSMART Groups > GigaSMART Groups. b. Click New. c. Type gsgp2 in the Alias field to identify this GigaSMART Group. d. Click in the Port List field and select an engine port. For example, 1/5/e1. e. Click Save.
2.	Display the information about the GigaSMART Group.	<ul style="list-style-type: none"> • On the GigaSMART Group page, click on the alias gsgp2 to display the GigaSMART Group Quick View.

Ex 1, Step 2: Configure the NetFlow Generation Exporter

Configure one or more NetFlow Generation Exporters. There can be up to 6 NetFlow Generation Exporters for each NetFlow Generation Monitor.

The following parameters apply to this example:

- **Transport Protocol** — the UDP port of the collector.
- **Version** — the version is either **NetFlow-v9** or **IPFIX**. The NetFlow version must be configured with the same version of the Exporter and the Record. If no version is specified, version 9 is the default.
- **Template Refresh Interval** — after each template-refresh-interval, the record template is sent to the collector. Also, the option template is sent.

- **SNMP** — enables SNMP packet support for the NetFlow exporter.
- **Destination IP** — the IP address of the NetFlow/IPFIX collector.
- **DSCP** — the DSCP priority of the packet.
- **TTL** — the Time to Live of the packet.

Step	Description	UI Steps
1.	Configure the exporter. The exporter (exp4) will be used in Ex 1, Step 8: Configure Mapping Rules to Filter Packets .	<ol style="list-style-type: none"> From the device view, select GigaSMART > NetFlow / IPFIX Generation > Exporters. Click New. Set NetFlow Exporter Info as follows: Alias: exp4. Version: IPFIX Template Refresh Interval: 60 Enable SNMP. Set Transport Configuration. Transport Protocol: UDP IP Version: v4 Destination IP: 20.20.20.20 Destination Port: 2055 DSCP: 10 TTL: 64 Click Save.
2.	Display the exporter configuration.	<ol style="list-style-type: none"> From the device view, select GigaSMART > NetFlow / IPFIX Generation > Exporters. Click on the row with the alias exp4 to display the details in the Exporter Quick View.

Ex 1, Step 3: Configure the IP Interface with Tool Port and Associate with the Exporter

Create an IP interface with tool port. You must associate this IP interface with the NetFlow Exporter you configured in [Ex 1, Step 2: Configure the NetFlow Generation Exporter](#).

Step	Description	UI Steps
1.	Identify the collector port and configure it as a tool port, where the NetFlow collector will be connected.	<ol style="list-style-type: none"> Identify the port to use as an IP interface with tool port. For example, 1/1/g3. Select Ports > All Ports. Use the Quick Port Editor to configure port 1/1/g3 as a tool port.
2.	Configure the IP interface. The IP address is for the NetFlow interface.	<ol style="list-style-type: none"> Select Ports > IP Interfaces. Click New.

Step	Description	UI Steps
		<ul style="list-style-type: none"> c. In the Alias and Comment fields, enter the name and description of the IP interface. d. From the Port drop-down list, select port 1/1/g3. e. Enter 10.10.10.10 in the IP Address field. f. Enter 255.255.255.255 in the Mask field g. Enter 10.10.10.1 in the Gateway field. h. Enter 1500 in the MTU field. i. Select the GigaSMART Group created in Ex 1, Step 1: Configure the GigaSMART Group. j. Click Save.
3.	Display the IP interface configuration.	<ul style="list-style-type: none"> a. Select Ports > IP Interfaces. b. Click on the row for port 1/1/g3 to display the IP interface details in a Quick View.

Ex 1, Step 4: Configure the Record

Configure one or more NetFlow Generation Records, which have the following:

- **Match** parameters that identify unique flows
- **Collect** parameters that identify fields you want to collect for the unique flows

NOTE: NetFlow v9 and IPFIX let you configure Match/Key and Collect/Non-Key elements. For details refer to [NetFlow Generation Match/Key and Collect/Non-Key Elements](#).

The following NetFlow Record parameters apply to this example:

- **Version** — the version is either **NetFlow-v9** or **IPFIX**. The NetFlow version must be configured with the same version of the Exporter and the Record. If no version is specified, version 9 is the default.
- **Key Fields (Match)** — the parameters that identify unique flows. The available Match/Key fields are based on the configured NetFlow version.
- **Non-Key Fields (Collect)** — the parameters that identify what you want to collect for the unique flows. The number of Collect/Non-Key elements in a record can be up to 32.

In this example, the IP source and destination address on the incoming traffic is used to identify network traffic between the unique pair of source and destination addresses. Once unique flows are identified, the following sample parameters are collected and exported for each flow:

- IP source and destination address
- Total number of packets received that match the unique flows

- IPv4 protocol
- Transport source and destination ports
- Input and output interface, plus interface name
- Packet URL
- DNS query name
- Timestamp for the beginning and end of flow

NOTE: Configure the NetFlow version prior to configuring the match and collect parameters because the subsequent parameters depend on the NetFlow version configured. If no version is specified, the version 9 is the default (NetFlow-v9).

Task	Description	UI Steps
1.	<p>Configure the record. The NetFlow version must be the same as the NetFlow version specified in Ex 1, Step 2: Configure the NetFlow Generation Exporter.</p> <p>The record (rec2) will be used in Ex 1, Step 5: Configure the Monitor.</p>	<ol style="list-style-type: none"> From the device view, select GigaSMART > NetFlow / IPFIX Generation > Records. Click New. Type rec2 in the Alias field. Select IPFIX for Version. Click in the Key Fields (Match) field and select IPv4. <ul style="list-style-type: none"> Select Source, and then select Address Select Destination, and then select Address Click in Non-Key Fields (Collect) and Select IPv4. <ul style="list-style-type: none"> Select Source, and then select Address Select Destination, and then select Address Click in Non-Key Fields (Collect) and select Counter. <ul style="list-style-type: none"> Select Bytes Select Packets Click in Non-Key Fields (Collect) and select Transport. <ul style="list-style-type: none"> Select Source Port Click in Non-Key Fields (Collect) and select Interface. <ul style="list-style-type: none"> Select Output Click in Non-Key Fields (Collect) and select Private. <ul style="list-style-type: none"> PEN is gigamon Select URL Click in Non-Key Fields (Collect) and select Timestamp. <ul style="list-style-type: none"> Select Sys-Uptime First

Task	Description	UI Steps
		<ul style="list-style-type: none"> Select Sys-Uptime Last <ol style="list-style-type: none"> Click Save.
2.	<p>Configure a second record. The NetFlow version must be the same as the NetFlow version specified in Ex 1, Step 2: Configure the NetFlow Generation Exporter. The match fields must be the same as in Step 1. Each record must have the same match fields but differing collect fields.</p> <p>The record (rec3) will be used in Ex 1, Step 5: Configure the Monitor.</p>	<ol style="list-style-type: none"> From the device view, select GigaSMART > NetFlow / IPFIX Generation > Records. Click New. Type rec3 in the Alias field. Select IPFIX for Version. Click in the Key Fields (Match) field and select IPv4. <ul style="list-style-type: none"> Select Source, and then select Address Select Destination, and then select Address Click in Non-Key Fields (Collect) and Select IPv4. <ul style="list-style-type: none"> Select Source, and then select Address Select Destination, and then select Address Click in Non-Key Fields (Collect) and select Private. <ul style="list-style-type: none"> PEN is gigamon Select URL Select Query Name under DNS Click in Non-Key Fields (Collect) and select Timestamp. <ul style="list-style-type: none"> Select Sys-Uptime First Select Sys-Uptime Last Click Save.
3.	Display the record configuration.	<ul style="list-style-type: none"> Click on the row with the alias rec2 to display the Record Quick View.

Ex 1, Step 5: Configure the Monitor

Configure a NetFlow Generation Monitor and associate the NetFlow Generation Record to the specified NetFlow Generation Monitor.

The following parameters show the binding of the records. The parameters also define the cache (holding statistics for unique flows).

- **Cache Timeout Event** — Set to **Transaction End**. This applies to the TCP flow. The flow is “flushed out” to the Exporter after detecting a FIN or RST.
- **Cache Timeout Active** — Despite the flow being active, it is “flushed out” to the Exporter after this timeout, which is set in seconds.

- **Cache Timeout inactive** — Inactive flows are “flushed out” to the Exporter after this timeout, which is set in seconds.
- **Sampling** — Enables sampled NetFlow and defines the sampling rate by specifying a number for 1 in N, where N is the packet count from 10 to 16000.
- **Records** — Records generated for the flow are defined in the record and are stored in the internal cache.

Step	Description	UI Steps
1.	<p>Configure the monitor. The monitor (mon2) will be used in Ex 1, Step 8: Configure Mapping Rules to Filter Packets.</p> <p>The records (rec2 and rec3) were created in Ex 1, Step 4: Configure the Record.</p> <p>In this example, NetFlow sampling is enabled. The sampling rate is 1 in 1024.</p>	<ol style="list-style-type: none"> From the device view, select GigaSMART > NetFlow > Monitors. Click New. Type mon2 in the Alias field. Define Config Cash Type: Normal Cash Timeout Event: Transaction End Cash Timeout Active: 60 Cash Timeout Inactive: 15 Sampling: 1024 Select Record(s) Select rec2 Select rec3 Click Save.
2.	Display the monitor configuration.	<ul style="list-style-type: none"> Click on the row with the alias mon2 to display the Monitor Quick View.

Ex 1, Step 6: Add the monitor to the GigaSMART Group

Add the monitor created in [Ex 1, Step 5: Configure the Monitor](#) to the GigaSMART Group created in [step Ex 1, Step 1: Configure the GigaSMART Group](#).

NOTE: Only one NetFlow Generation Monitor can be configured per gsgroup.

Step	Description	UI Steps
1.	Select the GigaSMART Group configured in Ex 1, Step 1: Configure the GigaSMART Group .	<ol style="list-style-type: none"> From the device view, select GigaSMART > GigaSMART Groups > GigaSMART Groups. On the GigaSMART Groups page, select gsgp2. Click Edit. Click in the Monitor field and select the NetFlow Monitor created in Ex 1, Step 5: Configure the Monitor

Step	Description	UI Steps
		<ul style="list-style-type: none"> e. Click Save.
2.	Display the GigaSMART Group information.	<ul style="list-style-type: none"> a. From the device view, select GigaSMART Groups > GigaSMART Groups. b. On the GigaSMART Groups page, click on the alias to display the information in a Quick View.

Ex 1, Step 7: Configure the GigaSMART Operation

Define a GigaSMART Operation to enable NetFlow Generation as follows:

Step	Description	UI Steps
1.	Configure the GigaSMART Operation and associate it with the GigaSMART Group created in Ex 1, Step 1: Configure the GigaSMART Group	<ul style="list-style-type: none"> a. From the device view, select GigaSMART > GigaSMART Operations (GSOP) > GigaSMART Operation. b. Click New. c. Type an alias in the Alias field to identify this operation. For example, gsop2. d. For GigaSMART Groups, select gsgp2. e. For GigaSMART Operations (GSOP), select NetFlow. f. Click Save.
2.	Display the configuration GigaSMART Operation.	<ul style="list-style-type: none"> • On the GigaSMART Operations page, click on the alias gsop2 to open the GigaSMART Operation Quick View.

Ex 1, Step 8: Configure Mapping Rules to Filter Packets

To add flow mapping rules to filter packets that are needed to run NetFlow, configure a map and associate the map to the IP interface with tool port, as follows:

Step	Description	UI Steps
1.	Configure the map. (This is a first level map.)	<ul style="list-style-type: none"> a. Select Maps > Maps > Maps. b. Click New. c. Type map3 in the Alias field. d. Select Regular for Type and By Rule for Subtype. e. Select the network port for Source. For example 1/1/x11 f. Select 1/1/g3 for Destination. This is the IP interface configured in Ex 1, Step 3: Configure the IP Interface with Tool Port and Associate with the Exporter. g. Click Add a Rule.

Step	Description	UI Steps
		Select IP Version. Set Version to 4. h. Click Save.
2.	Display the map configuration.	<ul style="list-style-type: none"> Click on the row for map3 to display the Quick View for the map.

Example 2: NetFlow Generation Configuration

Starting in software version 4.2, NetFlow exporters can filter NetFlow records. The filtered NetFlow records are sent to the collectors.

In Example 2, there are three exporters, with filtering configured on two of them. Because the second exporter does not have any filtering configured, all the records are sent to the collector. In this example, there are also two tunnels and two maps. Both maps are first level maps.

Ex 2, Step 1: Configure the GigaSMART Group

Configure a GigaSMART group and associate it with a GigaSMART engine port, as follows:

Step	Description	UI Steps
1.	Configure the GigaSMART Group	<ul style="list-style-type: none"> a. From the device view, select GigaSMART > GigaSMART Groups > GigaSMART Groups. b. Click New. c. Type grp in the Alias field to identify this GigaSMART Group. d. Click in the Port List field and select an engine port. For example, 1/5/e1. e. Click Save.
2.	Display the information about the GigaSMART Group.	<ul style="list-style-type: none"> On the GigaSMART Group page, click on the alias gsgp2 to display the GigaSMART Group Quick View.

Ex 2, Step 2: Configure the Exporters

Configure one or more NetFlow Generation Exporter(s), as follows:

Task	Description	UI Steps
1.	Configure the first exporter.	<ol style="list-style-type: none"> a. From the device view, select GigaSMART > NetFlow / IPFIX Generation > Exporters. b. Click New. c. Set NetFlow Exporter Info <ul style="list-style-type: none"> • Alias: exp1. • Version: IPFIX • Template Refresh Interval: Use the default d. Select SNMP e. Set Transport Configuration. <ul style="list-style-type: none"> • Transport Protocol: UDP • IP Version: v4 • Destination IP: 1.1.1.1 • Destination Port: 2055 • DSCP: 0 • TTL: 64 f. Add Filter Rule 1 <ul style="list-style-type: none"> • Click Add a Rule • Select IPv4 Destination • Enter 1.1.1.1 for the IPv4 Address • Enter 255.255.255.248 for the Net Mask • Select 0. g. Add Filter Rule 2 <ul style="list-style-type: none"> • Click Add a Rule. • Select VLAN. • Enter 1 for min. • Set Position to 0. h. Add Filter Rule 3 <ul style="list-style-type: none"> • Click Add a Rule. • Select Port Destination. • Enter 1 for min. • Set Position to 0. i. Click Save.

Task	Description	UI Steps
2.	Configure the second exporter.	<ol style="list-style-type: none"> a. From the device view, select GigaSMART > NetFlow > Exporters. b. Click New. c. Set NetFlow Exporter Info <ul style="list-style-type: none"> • Alias: exp2. • Version: IPFIX • Template Refresh Interval: Use the default d. Select SNMP e. Set Transport Configuration. <ul style="list-style-type: none"> • Transport Protocol: UDP • IP Version: v4 • Destination IP: 2.2.2.2 • Destination Port: 2055 • DSCP: 0 • TTL: 64 f. Click Save.
3.	Configure the third exporter.	<ol style="list-style-type: none"> a. From the device view, select GigaSMART > NetFlow > Exporters. b. Click New. c. Set NetFlow Exporter Info <ul style="list-style-type: none"> • Alias: exp1. • Version: IPFIX • Template Refresh Interval: Use the default d. Select SNMP e. Set Transport Configuration. <ul style="list-style-type: none"> • Transport Protocol: UDP • IP Version: v4 • Destination IP: 3.3.3.3 • Destination Port: 2055 • DSCP: 0 • TTL: 64 f. Add Filter Rule 1 <ul style="list-style-type: none"> • Click Add a Rule • Select IPv4 Destination

Task	Description	UI Steps
		<ul style="list-style-type: none"> • Enter 3.3.3.3 for the IPv4 Address • Enter 255.255.255.248 for the Net Mask • Select 0. g. Add Filter Rule 2 • Click Add a Rule. • Select VLAN. • Enter 3 for min. • Set Position to 0. h. Add Filter Rule 3 • Click Add a Rule. • Select Port Destination. • Enter 3 for min. • Set Position to 0. i. Click Save.

Ex 2, Step 3: Configure the IP Interfaces with Tool Ports and Associate with the Exporters

In this example, create two IP interfaces with tool ports. You must associate these IP interfaces with the NetFlow Exporters in [Ex 2, Step 2: Configure the Exporters](#).

Task	Description	UI Steps
1.	Identify the collector ports and configure them as a tool ports, where the NetFlow collector will be connected	<ul style="list-style-type: none"> a. Identify the ports to use as an IP interface with tool port. For example, 1/1/g1 and 1/1/g2. b. Select Ports > All Ports. c. Use the Quick Port Editor to configure port 1/1/g1 and 1/1/g2 as tool ports. d. Click OK.
2.	Configure the first IP interface.	<ul style="list-style-type: none"> a. Select Ports > IP Interfaces. b. Click New. c. In the Alias and Comment fields, enter the name and description for the IP interface. d. Select the tool port 1/1/g1 from the Port list. e. Set the IP address to 1.1.1.1. f. Set the IP Mask to 255.255.0.0. g. Set the Gateway address to 3.3.3.3.

Task	Description	UI Steps
		<ul style="list-style-type: none"> h. Set MTU to 2000. i. Select the GigaSMART Group grp from the GigaSMART Group list. j. From the Exporters drop-down list, select the first Exporter that you configured. k. Click OK.
3.	Configure the second IP interface.	<ul style="list-style-type: none"> a. Select Ports > IP Interfaces. b. Click New. c. In the Alias and Comment fields, enter the name and description of the IP interface. d. Select the tool port 1/1/g2 from the Port list. e. Set the IP address to 2.2.2.2. f. Set the IP Mask to 255.255.255.248. g. Set the Gateway address to 4.4.4.4. h. Set MTU to 2000. i. Select the GigaSMART Group grp from the GigaSMART Group list. j. From the Exporters drop-down list, select the third Exporter that you configured. k. Click Save.
4.	Display the IP interfaces configurations.	<ul style="list-style-type: none"> • Select Ports > IP Interfaces. On the IP Interfaces page, click on the IP interfaces to display the details.

Ex 2, Step 4: Configure the Record

Configure a NetFlow Generation Record, as follows:

Task	Description	UI Steps
1.	Configure the record.	<ul style="list-style-type: none"> a. From the device view, select GigaSMART > NetFlow / IPFIX Generation > Records. b. Click New. c. Type rec1 in the Alias field. d. Select IPFIX. e. Configure Key Fields (Match) <ul style="list-style-type: none"> • IPv4 TLL • IPv6 Traffic Class f. Configure Non-Key Fields (Collect)

Task	Description	UI Steps
		<ul style="list-style-type: none"> IPv6 Transport UDP Source Port IPv6 Transport Transport TCP Source Port <p>g. Click Save.</p>
2.	Display the record configuration.	<ul style="list-style-type: none"> Click on the row with the Alias rec1 to display the Record Quick View.

Ex 2, Step 5: Configure the Monitor

Configure a NetFlow Generation Monitor and associate the NetFlow Generation Record to the specified NetFlow Generation Monitor, as follows:

Task	Description	UI Step
1.	Configure the monitor. <div style="border: 1px solid #ccc; padding: 5px; margin-top: 10px;"> <p>NOTE: In this example, NetFlow sampling is not enabled.</p> </div>	<p>a. From the device view, select GigaSMART > NetFlow / IPFIX Generation > Records.</p> <p>b. Click New.</p> <p>c. Type mon1 in the Alias field.</p> <p>d. Select rec1 from the Record list.</p> <p>e. Click Save.</p>
2.	Display the monitor configuration.	<ul style="list-style-type: none"> Click on the row with the Alias mon1 to display the Monitor Quick View.

Ex 2, Step 6: Add the Monitor to the GigaSMART Group

Add the monitor created in [Ex 1, Step 5: Configure the Monitor](#) to the GigaSMART Group created in step [Ex 1, Step 1: Configure the GigaSMART Group](#).

NOTE: Only one NetFlow Generation Monitor can be configured per gsgroup.

Step	Description	UI Steps
1.	Select the GigaSMART Group configured in Ex 2, Step 1: Configure the GigaSMART Group .	<p>a. From the device view, select GigaSMART > GigaSMART Groups > GigaSMART Groups.</p> <p>b. On the GigaSMART Groups page, select gsgp2.</p> <p>c. Click Edit.</p> <p>d. Click in the Monitor field and select the NetFlow</p>

Step	Description	UI Steps
		<p>Monitor created in Ex 2, Step 5: Configure the Monitor</p> <p>e. Click Save.</p>
2.	Display the GigaSMART Group information.	<p>a. From the device view, select GigaSMART Groups > GigaSMART Groups.</p> <p>b. On the GigaSMART Groups page, click on the alias to display the information in a Quick View.</p>

Ex 2, Step 7: Configure the GigaSMART Operation

Define a GigaSMART Operation to enable NetFlow Generation, as follows:

Step	Description	UI Steps
1.	Configure the GigaSMART Operation and associate it with the GigaSMART Group created in Ex 2, Step 1: Configure the GigaSMART Group	<p>a. From the device view, select GigaSMART > GigaSMART Operations (GSOP) > GigaSMART Operation.</p> <p>b. Click New.</p> <p>c. Type an alias in the Alias field to identify this operation. For example, gsop2.</p> <p>d. For GigaSMART Groups, select grp.</p> <p>e. For GigaSMART Operations (GSOP), select NetFlow.</p> <p>f. Click Save.</p>
2.	Display the configuration GigaSMART Operation.	<ul style="list-style-type: none"> On the GigaSMART Operations page, click on the alias gsop2 to open the GigaSMART Operation Quick View.

Ex 2, Step 8: Configure Mapping Rules to Filter Packets

To add flow mapping rules to filter packets that are needed to run NetFlow, configure maps and associate the maps to the IP interfaces with tool ports, as follows:

Task	Description	UI Steps
1.	Configure the first map. (This is a first level map.)	<p>a. Select Maps > Maps > Maps.</p> <p>b. Click New.</p> <p>c. Type map1 in the Alias field.</p> <p>d. Select Regular for Type and By Rule for Subtype.</p> <p>e. Set network ports 1/1/x1 and 1/1/x2 as the Source.</p> <p>f. Set tool port 1/1/g1 as the Destination.</p> <p>g. From the device view, select GigaSMART Group for this map from the GSOP list. For example, gsop1.</p>

Task	Description	UI Steps
		<ul style="list-style-type: none"> h. Click Add a Rule. i. Select IP Version. j. Set Version to v4. k. Click Save.
2.	Configure the second map. (This is also a first level map.)	<ul style="list-style-type: none"> a. Select Maps > Maps > Maps. b. Click New. c. Type map2 in the Alias field. d. Select Regular for Type and By Rule for Subtype. e. Set network ports 1/1/x3 and 1/1/x4 as the Source. f. Set tool port 1/1/g1 as the Destination. g. From the device view, select GigaSMART Group for this map from the GSOP list. For example, gsop1. h. Click Add a Rule. i. Select Pass j. Select IP Version. k. Set Version to v4. l. Click Save.
3.	Display the map configuration.	<ul style="list-style-type: none"> a. Select Table View. b. Select alias of the port to see the Quick View for the port.

Example 3: NetFlow Generation Configuration

Starting in software version 4.3.01, NetFlow supports both first level and second level maps. In Example 3, there are two maps. However, unlike Example 2, which has two first level maps, in this example, one map is a first level map and the other is a second level map. A virtual port is configured that directs traffic to the second level map.

The configuration of the GigaSMART operation in Example 3 differs from Example 1 and Example 2. The GigaSMART Operation sends traffic to APF first, and then to NetFlow.

In the first level map, the traffic matching the rule is sent to the virtual port. The same traffic is also sent to two tool ports (2/1/g2 and 2/1/g3).

In the second level map, the traffic from the virtual port matching the gsrule is sent to NetFlow and then to the IP interface with tool port, 2/1/g7.

Ex 3, Step 1: Configure the GigaSMART Group

Configure a GigaSMART group and associate it with a GigaSMART engine port, as follows:

Step	Description	UI Steps
1.	Configure the GigaSMART Group	<ul style="list-style-type: none"> a. From the device view, select GigaSMART > GigaSMART Groups > GigaSMART Groups. b. Click New. c. Type grp in the Alias field to identify this GigaSMART Group. d. Click in the Port List field and select an engine port. For example, 1/5/e1. e. Click Save.
2.	Display the information about the GigaSMART Group.	<ul style="list-style-type: none"> • On the GigaSMART Group page, click on the alias gsgp2 to display the GigaSMART Group Quick View.

Ex 3, Step 2: Configure IP Interface and Associate with Exporter

Configure the IP interface and associate with the NetFlow Generation Exporter, as follows:

Task	Description	UI Steps
	Configure the IP interface.	<ul style="list-style-type: none"> a. Select Ports > IP Interfaces b. Click New. c. In the Alias and Comment fields, enter the name and description of the IP interface. d. Click in the Port field and select the tool port 1/1/g7. e. Set the IP address to 10.115.9.5. f. Set the IP Mask to 255.255.248.0. g. Set the Gateway address to 10.115.8.1. h. Set MTU to 1500. i. Select the GigaSMART Group created in Ex 3, Step 1: Configure the GigaSMART Group. j. From the Exporters drop-down list, select exp1. k. Click OK.

Ex 3, Step 3: Configure IP Interface with Tool Port

Create an IP interface with tool port.

Step	Description	UI Steps
1.	Identify the collector port and configure it as a tool port, where the NetFlow collector will be connected.	<ul style="list-style-type: none"> a. Identify the port to use as an IP interface with tool port. For example, 1/1/g7. b. Select Ports > All Ports.

Step	Description	UI Steps
		<ul style="list-style-type: none"> c. Use the Quick Port Editor to configure port 1/1/g3 as tool port.
2.	Configure the IP interface. The IP address is for the NetFlow interface.	<ul style="list-style-type: none"> a. Select Ports > IP Interfaces. b. Click New. c. In the Alias and Comment fields, enter the name and description of the IP interface. d. Click in the Port field and select port 1/1/g3. e. Enter 10.115.9.5 in the IP Address field. f. Enter 255.255.255.255 in the Mask field g. Enter 10.115.9.1 in the Gateway field. h. Enter 1500 in the MTU field. i. Select the GigaSMART Group created in Ex 1, Step 1: Configure the GigaSMART Group. j. Click Save.
3.	Display the IP interface configuration.	<ul style="list-style-type: none"> a. Select Ports > IP Interfaces. b. Click on the row for port 1/1/g7 to display the IP Interfaces details in a Quick View.

Ex 3, Step 4: Configure Record

Configure a NetFlow Generation Record, as follows:

	Description	UI Steps
	Configure the record.	<ul style="list-style-type: none"> a. From the device view, select GigaSMART > NetFlow > Records. b. Click New. c. Type rec1 in the Alias field. d. Select IPFIX. e. Configure Key Fields (Match) Select TOS. Select IPv4 and enable Source. Select Address. f. Configure Non-Key Fields (Collect) Select IPv4 and enable Source. Select Interface. g. Click Save.

Ex 3, Step 5: Configure the Monitor

Configure a NetFlow Generation Monitor and associate the NetFlow Generation Record to the specified NetFlow Generation Monitor, as follows:

	Description	UI Steps
	Configure the monitor.	<ol style="list-style-type: none"> a. From the device view, select GigaSMART > NetFlow > Records. b. Click New. c. Type mon1 in the Alias field. d. Select rec1 from the Record list. e. Click Save.

Ex 3, Step 6: Add the Monitor to the GigaSMART Group

Add the monitor created in [Ex 3, Step 5: Configure the Monitor](#) to the GigaSMART Group created in step [Ex 3, Step 1: Configure the GigaSMART Group](#).

NOTE: Only one NetFlow Generation Monitor can be configured per gsgroup.

Step	Description	UI Steps
1.	Select the GigaSMART Group configured in Ex 3, Step 1: Configure the GigaSMART Group .	<ol style="list-style-type: none"> a. From the device view, select GigaSMART > GigaSMART Groups > GigaSMART Groups. b. On the GigaSMART Groups page, select grp. c. Click Edit. d. Click in the Monitor field and select the NetFlow Monitor created in Ex 3, Step 5: Configure the Monitor e. Click Save.
2.	Display the GigaSMART Group information.	<ol style="list-style-type: none"> a. From the device view, select GigaSMART Groups > GigaSMART Groups. b. On the GigaSMART Groups page, click on the alias to display the information in a Quick View.

Ex 3, Step 7: Configure the GigaSMART Operation

Define a GigaSMART Operation to enable NetFlow Generation, as follows:

Step	Description	UI Steps
1.	Configure the GigaSMART Operation and associate it with the GigaSMART Group	<ol style="list-style-type: none"> a. From the device view, select GigaSMART > GigaSMART Operations (GSOP) > GigaSMART Operation.

Step	Description	UI Steps
	created in Ex 3, Step 1: Configure the GigaSMART Group	<ul style="list-style-type: none"> b. Click New. c. Type an alias in the Alias field to identify this operation. For example, gsop2. d. For GigaSMART Groups, select grp. e. For GigaSMART Operations (GSOP), select NetFlow. f. Click Save.
2.	Display the configuration GigaSMART Operation.	<ul style="list-style-type: none"> • On the GigaSMART Operations page, click on the alias gsop2 to open the GigaSMART Operation Quick View.

Ex 3, Step 8: Configure the Virtual Port

For the second level map that you will create in [Ex 3, Step 9: Configure Mapping Rules to Filter Packets](#), you will need to create a virtual port.

Configure a virtual port and associate it with the GigaSMART group, as follows:

Step	Description	UI Steps
1.	Configure the virtual port for the second level map.	<ul style="list-style-type: none"> a. From the device view, select GigaSMART > Virtual Ports. b. On the GigaSMART Groups page, select grp. c. Click New. d. Type an alias for the virtual port in the Alias field. For example, vp1. e. Click in the GigaSMART Group field and select the GigaSMART Group created in Ex 3, Step 1: Configure the GigaSMART Group. f. Click Save.
2.	Display the virtual port information.	<ul style="list-style-type: none"> a. From the device view, select GigaSMART Groups > Virtual Ports. b. On the Virtual Ports page, click on the virtual port alias to display the information in a Quick View.

Ex 3, Step 9: Configure Mapping Rules to Filter Packets

To add flow mapping rules to filter packets that are needed to run NetFlow, configure maps and associate the maps to the IP interface with tool port, as follows:

Task	Description	UI Steps
1.	Configure the first map. (This is a	<ul style="list-style-type: none"> a. Select Maps > Maps > Maps.

Task	Description	UI Steps
	first level map.)	<ul style="list-style-type: none"> b. Click New. c. Type map1 in the Alias field. d. Select First Level for Type and By Rule for Subtype. e. Set network port 1/1/g1 as the Source. f. Set virtual port v1 and tool ports 21/1/g2 and 2/1/g3 as the Destination. g. Click Add a Rule. h. Select Pass i. Select MAC Destination. j. Set the MAC address and mask to 00:00:00:00:00:00 k. Click Save.
2.	Configure the second map. (This is a second level map.)	<ul style="list-style-type: none"> a. Select Maps > Maps > Maps. b. Click New. c. Type map2 in the Alias field. d. Select Second Level for Type and By Rule for Subtype. e. Set virtual port v1 as the Source. f. Set tool port v1 2/1/g7 as the Destination. g. Select gsop_apf_netflow from the GSOP list. h. Click Add a Rule. i. Select Pass j. Select MAC Destination. k. Set the MAC address and mask to 00:00:00:00:00:00 l. Click Save.

Example 4: NetFlow Generation Configuration

Starting in software version 4.3.01, NetFlow supports both first level and second level maps. In Example 4, there are three maps. One map is a first level map and the other two are second level maps. Two virtual ports are configured that direct traffic to the second level maps.

Two GigaSMART operations are configured. One gsop sends traffic to masking. The other gsop sends traffic to APF and then to NetFlow.

In the first level map, the traffic matching the rule is sent to two virtual ports. The same traffic is also sent to a tool port (11/1/g3).

In the first second level map, the traffic from the first virtual port, vp1, that matches the gsrule, is sent to masking and then to the tool port 11/1/g2.

In the next second level map, the traffic from the second virtual port, vp2, that matches the gsrule, is sent to NetFlow and then to the IP interface with tool port, 11/1/g4.

Ex 4, Step 1: Configure the GigaSMART Group

Configure two GigaSMART groups and associate them with a GigaSMART engine port, as follows:

Step	Description	UI Steps
1.	Configure the first GigaSMART Group.	<ol style="list-style-type: none"> a. From the device view, select GigaSMART > GigaSMART Groups > GigaSMART Groups. b. Click New. c. Type an grp1 in the Alias field to identify this GigaSMART Group. d. Click in the Port List field and select an engine port. For example, 1/5/e1. e. Click Save.
2.	Configure the second GigaSMART Group	<ol style="list-style-type: none"> a. From the device view, select GigaSMART > GigaSMART Groups > GigaSMART Groups. b. Click New. c. Type an grp2 in the Alias field to identify this GigaSMART Group. d. Click in the Port List field and select an engine port. For example, 1/5/e1. e. Click Save.
3.	Display the information about the GigaSMART Group.	<ul style="list-style-type: none"> • On the GigaSMART Group page, click on the alias gsgp2 to display the GigaSMART Group Quick View.

Ex 4, Step 2: Configure the IP Interface with Tool Port

Create an IP interface with tool port. You must associated this IP interface with the NetFlow Exporter in [Ex 4, Step 3: Configure the IP Interface and Associate with Exporter](#).

Step	Description	UI Steps
1.	Identify the collector port and configure it as a tool port, where the NetFlow collector will be connected.	<ol style="list-style-type: none"> a. Identify the port to use as an IP interface with tool port. For example, 1/1/g3. b. Select Ports > All Ports. c. Use the Quick Port Editor to configure port 1/1/g3 as tool port.
2.	Configure the IP interface. The IP address is for the NetFlow interface.	<ol style="list-style-type: none"> a. Select Ports > IP Interfaces. b. Click New. c. In the Alias and Comment fields, enter the name and description of the IP interface. d. Click in the Port field and select port 1/1/g3. e. Enter 10.10.10.10 in the IP Address field.

Step	Description	UI Steps
		<ul style="list-style-type: none"> f. Enter 255.255.255.255 in the Mask field g. Enter 10.10.10.1 in the Gateway field. h. Enter 1500 in the MTU field. i. Select the GigaSMART Group grp2 created in Ex 4, Step 1: Configure the GigaSMART Group. j. Click Save.
3.	Display the IP interfaces configuration.	<ul style="list-style-type: none"> a. Select Ports > IP Interfaces. b. Click on the row for port 1/1/g3 to display the details in a Quick View.

Ex 4, Step 3: Configure the IP Interface and Associate with Exporter

Configure the IP interface and associate the NetFlow Generation Exporter, as follows:

	Description	Command
	Configure the IP interface.	<ul style="list-style-type: none"> a. Select Ports > IP Interfaces. b. Click New. c. In the Alias and Comment fields, enter the name and description of the IP interface. d. Click in the Port field and select the IP interface configured in Ex 4, Step 2: Configure the IP Interface with Tool Port. e. Set the IP address to 10.115.9.6. f. Set the IP Mask to 255.255.248.0. g. Set the Gateway address to 10.115.8.1. h. Set MTU to 1500. i. Select the GigaSMART Group grp2 from the GigaSMART Group list. j. From the Exporter drop-down list, select ex21. k. Click Save.

Ex 4, Step 4: Configure the Record

Configure a NetFlow Generation Record, as follows:

	Description	UI Steps
	Configure the record.	<ul style="list-style-type: none"> a. From the device view, select GigaSMART > NetFlow / IPFIX Generation > Records. b. Click New.

	Description	UI Steps
		<ul style="list-style-type: none"> c. Type rec1 in the Alias field. d. Select IPFIX. e. Configure Key Fields (Match) Select IPV4 Select TOS and then select Source. f. Configure Non-Key Fields (Collect) Select IPv4 and then select Protocol and Source Select Interface g. Click Save.

Ex 4, Step 5: Configure the Monitor

Configure a NetFlow Generation Monitor and associate the NetFlow Generation Record to the specified NetFlow Generation Monitor, as follows:

	Description	Command
	Configure the monitor.	<ul style="list-style-type: none"> a. From the device view, select GigaSMART > NetFlow / IPFIX Generation > Records. b. Click New. c. Type mon1 in the Alias field. d. Select Normal for Cache Type. e. Set Cache Timeout Active to 2. f. Set Cache Timeout Inactive to 2 g. Select rec1 from the Record list. h. Click Save.

Ex 4, Step 6: Add the Monitor to the GigaSMART Group

Add the monitor created in [Ex 4, Step 5: Configure the Monitor](#) to the GigaSMART Group created in [step Ex 4, Step 1: Configure the GigaSMART Group](#).

NOTE: Only one NetFlow Generation Monitor can be configured per gsgroup.

Step	Description	UI Steps
1.	Select the GigaSMART Group configured in Ex 4, Step 1: Configure the GigaSMART Group .	<ul style="list-style-type: none"> a. From the device view, select GigaSMART > GigaSMART Groups > GigaSMART Groups. b. On the GigaSMART Groups page, select grp2. c. Click Edit.

Step	Description	UI Steps
		<ul style="list-style-type: none"> d. Click in the Monitor field and select the NetFlow Monitor created in Ex 4, Step 5: Configure the Monitor e. Click Save.
2.	Display the GigaSMART Group information.	<ul style="list-style-type: none"> a. From the device view, select GigaSMART Groups > GigaSMART Groups. b. On the GigaSMART Groups page, click on the alias grp2 to display the information in a Quick View.

Ex 4, Step 7: Configure the GigaSMART Operation

Define the two GigaSMART operation to enable masking and NetFlow, as follows:

Step	Description	UI Steps
1.	Configure the first GigaSMART Operation for APF and masking	<ul style="list-style-type: none"> a. From the device view, select GigaSMART > GigaSMART Operations (GSOP) > GigaSMART Operation. b. Click New. c. Type gsop_mask_aa in the Alias field d. For the GigaSMART Group, select grp. e. Click in th GigaSMART Operations (GSOP) field and select Adaptive Packet Filtering. f. Click in th GigaSMART Operations (GSOP) field and select Masking. Set Masking as follows: Protocol: None Offset: 50 Pattern: aa. Length: 100 g. Click Save.
2.	Configure the second GigaSMART Operation for NetFlow	<ul style="list-style-type: none"> a. From the device view, select GigaSMART > GigaSMART Operations (GSOP) > GigaSMART Operation. b. Click New. c. Type an alias in the Alias field to identify this operation. For example, gsop2. d. For GigaSMART Group, select grp e. For GigaSMART Operations (GSOP), select NetFlow. f. Click Save.
3.	Display the configuration GigaSMART Operation.	<ul style="list-style-type: none"> • On the GigaSMART Operations page, click on the alias gsop2 to open the GigaSMART Operation Quick View.

Ex 4, Step 8: Configure the Virtual Port

For the second level map that you will create in [Ex 4, Step 9: Configure Mapping Rules to Filter Packets](#), you will need to create virtual ports.

Configure a virtual port and associate it with the GigaSMART group, as follows:

Step	Description	UI Steps
1.	Configure the first virtual port for the second level map.	<ol style="list-style-type: none"> a. From the device view, select GigaSMART > Virtual Ports. b. On the GigaSMART Groups page, select grp. c. Click New. d. Type vp1 in the Alias field. e. Click in the GigaSMART Group field and select grp1. f. Click Save.
7.	Configure the second virtual port for the second level map.	<ol style="list-style-type: none"> a. From the device view, select GigaSMART > Virtual Ports. b. On the GigaSMART Groups page, select grp. c. Click New. d. Type vp2 in the Alias field. e. Click in the GigaSMART Group field and select the grp2. f. Click Save.
4.	Display the virtual port information.	<ol style="list-style-type: none"> a. From the device view, select GigaSMART Groups > Virtual Ports. b. On the Virtual Ports page, click on the virtual port alias to display the information in a Quick View.

Ex 4, Step 9: Configure Mapping Rules to Filter Packets

To add flow mapping rules to filter packets that are needed to run NetFlow, configure maps and associate the maps to the IP interfaces with tool ports, as follows:

Task	Description	UI Steps
1.	Configure the first map. (This is a first level map.)	<ol style="list-style-type: none"> a. Select Maps > Maps > Maps. b. Click New. c. Type map1 in the Alias field. d. Select First Level for Type and By Rule for Subtype. e. Set network port 11/1/g1 as the Source. f. Set virtual ports v1 and v2 plus tool port 1/1/g3 as the Destination. g. Click Add a Rule.

Task	Description	UI Steps
		<ul style="list-style-type: none"> h. Select Pass i. Select MAC Destination. j. Set the MAC address and mask to 00:00:00:00:00:00 k. Click Save.
2.	Configure the second map. (This is a second level map.)	<ul style="list-style-type: none"> a. Select Maps > Maps > Maps. b. Click New. c. Type map2 in the Alias field. d. Select Second Level for Type and By Rule for Subtype. e. Set virtual port v1 as the Source. f. Set tool port v1 11/1/g2 as the Destination. g. Select gsof_mask_aa from the GSOP list. h. Click Add a Rule. i. Select Pass j. Select MAC Destination. k. Set the MAC address and mask to 00:00:00:00:00:00 l. Click Save.
3.	Configure the third map. (This is also a second level map.)	<ul style="list-style-type: none"> a. Select Maps > Maps > Maps. b. Click New. c. Type map2 in the Alias field. d. Select Second Level for Type and By Rule for Subtype. e. Set virtual port v2 as the Source. f. Set tool port v1 11/1/g4 as the Destination. g. Select gsof_apf_netflow from the GSOP list. h. Click Add a Rule. i. Select Pass j. Select MAC Destination. k. Set the MAC address and mask to 00:00:00:00:00:00 l. Click Save.

Display Exporter Statistics

To display exporter statistics, select **GigaSMART > GigaSMART Operations (GSOP) > Statistics** and open the GigaSMART Statistics Quick View to view the NetFlow Statistics.

Refer to [NetFlow Exporter Statistics Definitions](#) for descriptions of the statistics.

Display Monitor Statistics

To display exporter statistics, select **GigaSMART > GigaSMART Operations (GSOP) > Statistics** and open the GigaSMART Statistics Quick View to view the NetFlow Statistics.

Refer to [NetFlow Monitor Statistics Definitions](#) for descriptions of these statistics.

Display IP Interfaces Statistics

To display IP interfaces statistics, select **Ports > IP Interfaces > Statistics** and look for the IP interface ID in the statistics table.

Refer to [IP Interfaces Statistics Definitions](#) for descriptions of these statistics.

NetFlow Generation Configuration Modification and Removal

There may be instances where a NetFlow Generation configuration may require alteration by modifying a NetFlow Generation Monitor Configuration or a NetFlow Generation Record Configuration. It may further require that the configuration be removed entirely. In such instances, refer to the following.

Modify NetFlow Generation Monitor Configuration

This example shows the modification of a NetFlow Generation Monitor configuration.

1. Unlink the monitor from GigaSMART Parameters.
 - a. From the device view, select **GigaSMART > GigaSMART Groups > GigaSMART Groups**.
 - b. Select the GigaSMART group to modify.
 - c. Click **Edit**.
 - d. Under NetFlow, select **None** in the **Monitor** field.
 - e. Click **Save**.
2. Modify the monitor parameters.
 - a. From the device view, select **GigaSMART > NetFlow / IPFIX Generation > Monitors**.
 - b. Select the Monitor to modify.
 - c. Click **Edit**.
 - d. Under Config, modify the monitor parameters.
 - e. Select the record from the **Record(s)** list to re-add it to the monitor.
3. Re-add the monitor to GigaSMART Parameters for the changes to take affect.
 - a. From the device view, select **GigaSMART > GigaSMART Groups > GigaSMART Groups**.
 - b. Select the GigaSMART group to modify.
 - c. Click **Edit**.

- d. Under NetFlow, select the monitor in the **Monitor** field.
- e. Click **Save**.

Modify NetFlow Generation Record Configuration

This example shows the modification of a NetFlow Generation Record configuration.

1. Unlink the monitor from gsparams.
 - a. From the device view, select **GigaSMART > GigaSMART Groups > GigaSMART Groups**.
 - b. Select the GigaSMART group to modify.
 - c. Click **Edit**.
 - d. Under NetFlow, select **None** in the **Monitor** field.
 - e. Click **Save**.
2. Modify the record bound to the monitor.
 - a. From the device view, select **GigaSMART > NetFlow / IPFIX Generation > Records**.
 - b. Select the record to modify.
 - c. Click **Edit**.
 - d. Modify the record configuration.
3. Re-add the monitor to the GigaSMART Parameters for changes in record to take affect.
 - a. From the device view, select **GigaSMART > GigaSMART Groups > GigaSMART Groups**.
 - b. Select the GigaSMART group to modify.
 - c. Click **Edit**.
 - d. Under NetFlow, select the monitor in the **Monitor** field.
 - e. Click **Save**.

Remove NetFlow Generation Configuration

Use the following steps to remove a NetFlow Generation Configuration:

1. Remove the NetFlow parameter from the GigaSMART Group.
 - a. From the device view, select **GigaSMART > GigaSMART Groups > GigaSMART Groups**.
 - b. Select the GigaSMART Group.
 - c. Click **Edit**.
 - d. Under NetFlow, select **None** in the **Monitor** field.

2. Delete the Maps.
 - a. Select **Maps > Maps > Maps**.
 - b. Select Table View.
 - c. Select the Maps.
 - d. Click **Delete**.
3. Delete the IP interface.
 - a. Select **Ports > IP Interfaces**.
 - b. Select the port.
 - c. Click **Delete**.
4. Delete the monitor, records, and exporter
 - a. From the device view, select **GigaSMART > NetFlow / IPFIX Generation > Monitors**.
 - b. Select the monitor, and then click **Delete**.
 - c. Select **Records**
 - d. Select the record, and then click **Delete**
 - e. Select **Records**.
 - f. Select the record, and then click **Delete**.

V5 Fixed Record Template

NetFlow v5 records have a template of fixed fields that cannot be edited. The template contains Match/Key and Collect/Non-Key elements. It has an alias of **predefined_netflow_v5_record**.

To display the template, select **GigaSMART > NetFlow / IPFIX Generation > Records** and click on **predefined_netflow_v5_record** to display the Record Quick View shown in [Figure 438: NetFlow Record predefined_netflow_v5_record](#).

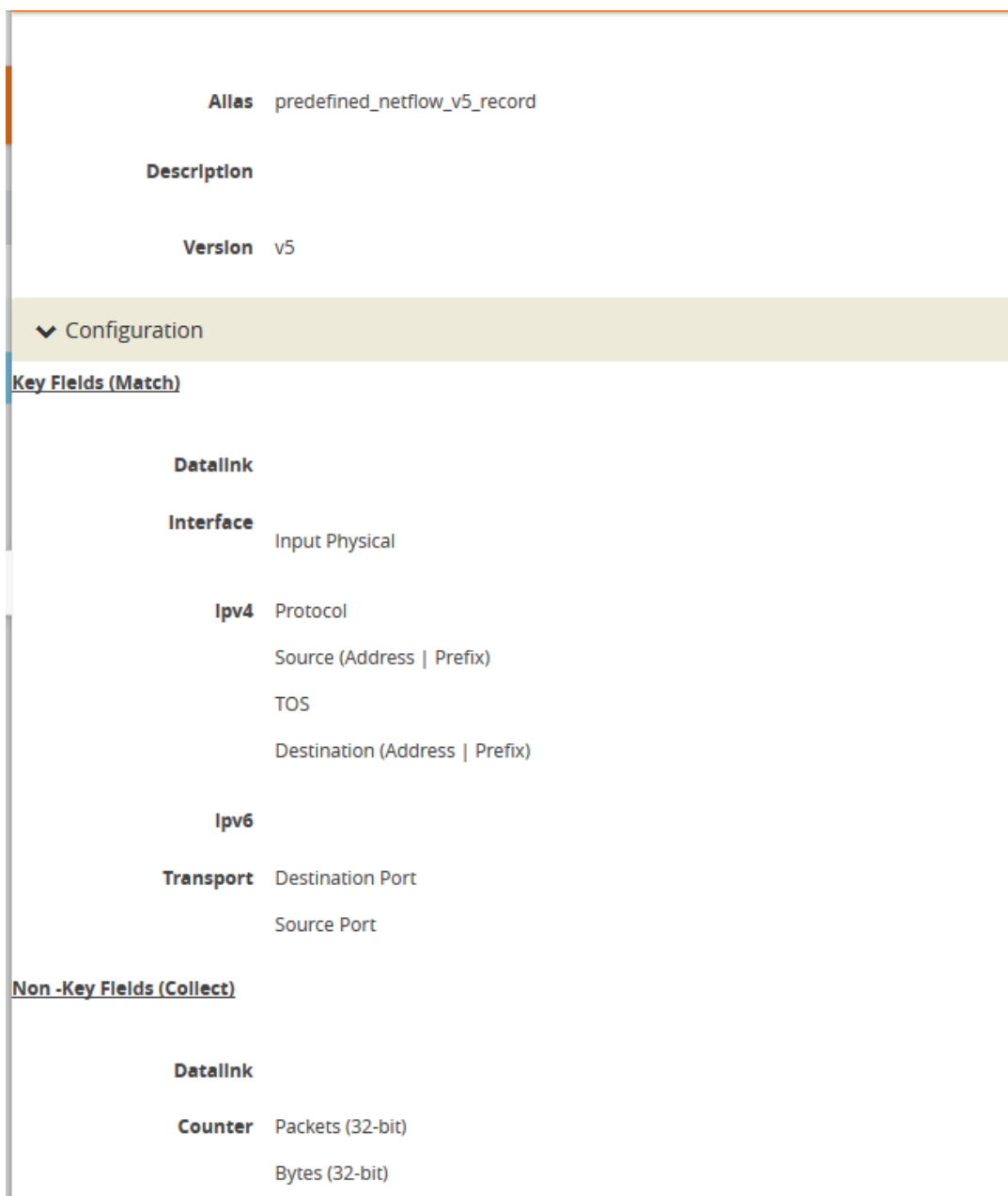


Figure 438: NetFlow Record predefined_netflow_v5_record

NetFlow Generation Match/Key and Collect/Non-Key Elements

NetFlow v9 and IPFIX records allow the user to configure Match/Key and Collect/Non-Key elements.

Match/Key Syntax

NetFlow v9 and IPFIX records allow the you to configure Match/Key elements.

NOTE: NetFlow v9 does not support Match/Key elements whose ID on the specified link is greater than 128. For additional information, refer to the following:

<http://www.iana.org/assignments/ipfix/ipfix.xhtml>

To configure the Match/Key elements, click in the Key Fields (Match) field in the NetFlow Record configuration page and select the match type.

The supported combinations of Match/Key elements are outlined in the following table:

Match Type	Parameters			Description
Data Link	Source Mac			Supported for v9 and IPFIX.
	Destination			Supported for v9 and IPFIX.
	VLAN			Supported for v9 and IPFIX.
Interface	Input physical	Physical Width-2 Physical Width-4		Supported for v9 and IPFIX. for width, the only supported values are 2 or 4.
IPv4	Destination	Address		Configures the IPv4 destination address as a key field. Supported for v9 and IPFIX.
		Prefix	<netmask mask_length>	Configures a prefix for the IPv4 destination address as a key field. Supported for v9 and IPFIX.
		DSCP		Supported only for IPFIX.
		Fragmentation Flags		Supported only for IPFIX.
		Fragmentation ID		Supported for v9 and IPFIX.
		Fragmentation Offset		Supported for v9 and IPFIX.
		Header Length		Supported only for IPFIX.
		Option Map		Supported only for IPFIX.
		Precedence		Supported only for IPFIX.

Match Type	Parameters			Description
	Protocol			Supported for v9 and IPFIX.
	Section	Header Size	<size>	Configures the number of bytes of raw data starting at the IPv4 header, to use as a key field. The range is from 1 to 128. Supported only for IPFIX.
		Payload Size	<size>	Configures the number of bytes of raw data starting at the IPv4 payload, to use as a key field. The range is from 1 to 128. Supported only for IPFIX.
	Source	Address		Supported for v9 and IPFIX.
		Prefix	<netmask mask_length>	Supported for v9 and IPFIX.
	TOS			Supported only for IPFIX.
	Total Length	maximum minimum		Supported only for IPFIX.
	TTL			Supported only for IPFIX.
	Version			Supported for v9 and IPFIX.
IPv6	Destination	Address		Supported for v9 and IPFIX.
		Prefix	<netmask mask_length>	Supported only for IPFIX.
	DSCP			Supported only for IPFIX.
	Extension Map			Supported for v9 and IPFIX.
	Flow Label			Supported for v9 and IPFIX.
	Fragmentation Flags			Supported only for IPFIX.
	Fragmentation ID			Supported for v9 and IPFIX.
	Fragmentation Offset			Supported for v9 and IPFIX.
	Hop Limit			Supported only for IPFIX.
	Length	Header		Supported only for IPFIX.
		Payload		Supported only for IPFIX.

Match Type	Parameters			Description
		Total		Supported only for IPFIX.
	Next Header			Supported only for IPFIX.
	payload-length			Supported only for IPFIX.
	Precedence			Supported only for IPFIX.
	Protocol			Supported for v9 and IPFIX.
	Section	Header Size	<size>	Supported only for IPFIX. The range is from 1 to 128.
		Payload Size	<size>	Supported only for IPFIX. The range is from 1 to 128.
	Source	Address		Supported for v9 and IPFIX.
		Prefix	<netmask mask_length>	Supported only for IPFIX.
	Traffic Class			Supported for v9 and IPFIX.
	Version			Supported for v9 and IPFIX.
Transport	Destination Port			Supported for v9 and IPFIX.
	ICMP	IPv4	Code	Supported only for IPFIX.
			Type	Supported only for IPFIX.
		IPv6	Code	Supported only for IPFIX.
			Type	Supported only for IPFIX.
	Source Port			Supported for v9 and IPFIX.
	TCP	ACK Number		Supported only for IPFIX.
		Destination Port		Supported only for IPFIX.
		Flags <enable disable>	[ACK] [CWR] [ECE] [FIN] [PSH] [RST] [SYN] [URG]	Supported only for v9 and IPFIX.
		Header Length		Supported only for IPFIX.
		Sequence Number		Supported only for IPFIX.
		Source Port		Supported only for IPFIX.
		Urgent Pointer		Supported only for IPFIX.

Match Type	Parameters		Description
		window-size	Supported only for IPFIX.
	UDP	Destination Port	Supported only for IPFIX.
		Message Length	Supported only for IPFIX.
		Source Port	Supported only for IPFIX.

Collect/Non-Key Syntax

NetFlow v9 and IPFIX records allow the user to configure Collect/Non-Key elements.

The number of Collect/Non-Key elements in a record can be up to 32. Each Collect/Non-Key element has a size. The accumulated size of the Collect/Non-Key elements in the record cannot exceed 1024 bytes. The supported Collect/Non-Key elements is determined either by the maximum number of elements in a record (32) or by the maximum size (1024 bytes), whichever is reached first.

NOTE: NetFlow v9 does not support Collect/Non-Key elements whose ID on the specified link is greater than 128. For additional information, refer to the following:

<http://www.iana.org/assignments/ipfix/ipfix.xhtml>

To configure the Collect/Non-Key elements, click in the **Non-Key Fields (Collect)** field in the NetFlow Record configuration page and select the match type.

The supported combinations of Collect/Non-Key elements are outlined in the following table:

Collect Type	Parameters	Size	Description
Counter	Bytes	32	Supported for v9 and IPFIX.
		64	
	Packets	32	Supported for v9 and IPFIX.
		64	
Datalink	Source		Supported for v9 and IPFIX.
	Mac Destination		Supported for v9 and IPFIX.
	VLAN		Supported for v9 and IPFIX.

Collect Type	Parameters	Size		Description	
Flow	End Reason			Supported only for IPFIX.	
Interface	Input Name	Input Width	[width]	Supported for v9 and IPFIX. For width, the range is from 1 to 32.	
	Physical	Physical Width-2 Physical Width-4		Supported for v9 and IPFIX. For width, the only supported values are 2 or 4.	
	Output	Physical Width-2 Physical Width-4		Supported for v9 and IPFIX. For width, the only supported values are 2 or 4.	
IPv4	Destination	Address		Configures the IPv4 destination address as a non-key field. Supported for v9 and IPFIX.	
		Prefix	<netmask mask_length>	Supported for v9 and IPFIX.	
	DSCP			Supported only for IPFIX.	
	Fragmentation Flags			Supported only for IPFIX.	
	Fragmentation ID			Supported for v9 and IPFIX.	
	Offset			Supported for v9 and IPFIX.	
	Header Length			Supported only for IPFIX.	
	Option Map			Supported only for IPFIX.	
	Precedence			Supported only for IPFIX.	
	Protocol			Supported for v9 and IPFIX.	
		Section	Header Size	<size>	Configures the number of bytes of raw data starting at the IPv4 header, to use as a key field. The range is from 1 to 128. Supported for v9 and IPFIX.
			Payload Size	<size>	Configures the number of bytes of raw data starting at the IPv4 payload to use as a key field. The range is from 1 to 128. Supported for v9 and IPFIX.

Collect Type	Parameters	Size		Description
	Source	Address		Supported for v9 and IPFIX.
		Prefix	<netmask mask_length>	Configures a prefix for the IPv4 destination address as a non-key field. Supported for v9 and IPFIX.
	TOS			Supported only for IPFIX.
	Total Length	[maximum]		Supported only for IPFIX.
		[minimum]		Supported only for IPFIX.
	TTL			Supported only for IPFIX.
	Version			Supported for v9 and IPFIX.
IPv6	Destination	Address		Supported for v9 and IPFIX.
		Prefix	<netmask mask_length>	Supported only for IPFIX.
	DSCP			Supported only for IPFIX.
	Extension Map			Supported for v9 and IPFIX.
	Flow Label			Supported for v9 and IPFIX.
	Fragmentation Flags			Supported only for IPFIX.
	Fragmentation ID			Supported for v9 and IPFIX.
	Fragmentation Offset			Supported for v9 and IPFIX.
	Hop Limit	[maximum]		Supported only for IPFIX.
		[minimum]		Supported only for IPFIX.
	Length	Header		Supported for v9 and IPFIX.
		Payload		Supported only for IPFIX.
		Total	[maximum]	Supported only for IPFIX.
			[minimum]	Supported only for IPFIX.
	Next Header			Supported only for IPFIX.
	Precedence			Supported only for IPFIX.
	Protocol			Supported for v9 and IPFIX.
	Section	Header Size	<size>	Supported only for IPFIX. The

Collect Type	Parameters	Size		Description
				range is from 1 to 128.
		Payload Size	<size>	Supported only for IPFIX. The range is from 1 to 128.
	Source	Address		Supported for v9 and IPFIX.
		Prefix	<netmask mask_length>	Configures a prefix for the IPv4 destination address as a non-key field. Supported only for IPFIX.
	Traffic Class			Supported for v9 and IPFIX.
	Version			Supported for v9 and IPFIX.
Private	PEN <pen name>	DNS	<additional-class [number-of-collects <1-10>] additional-class-text [number-of-collects <1-10>] additional-name [number-of-collects <1-10>] additional-rd-length [number-of-collects <1-10>] additional-rdata [number-of-collects <1-10> width <1- 128>] additional-ttl [number-of-collects <1-10>] additional-type [number-of-collects <1-10>] additional-type-text [number-of-collects <1-10>] an-count ar-count authority-class [number-of-collects <1-10>] authority-class-text [number-of-collects <1-10>]	Supported only for IPFIX.

Collect Type	Parameters	Size		Description
			authority-name [number-of-collects <1-10>] authority-rd-length [number-of-collects <1-10>] authority-rdata [number-of-collects <1-10> width <1-128>] authority-ttl [number-of-collects <1-10>] authority-type [number-of-collects <1-10>] authority-type-text [number-of-collects <1-10>] bits identifier ns-count op-code qd-count query-class [number-of-collects <1-10>] query-class-text [number-of-collects <1-10>] query-name [number-of-collects <1-10>] query-type [number-of-collects <1-10>]	
Private (continued)	PEN <pen name>	DNS	query-type-text [number-of-collects <1-10>] response-class [number-of-collects <1-10>] response-class-text [number-of-collects <1-10>] response-code response-ipv4-addr [number-of-collects <1-10>]	Supported only for IPFIX.

Collect Type	Parameters	Size		Description
			response-ipv4-addr-text [number-of-collects <1-10>] response-ipv6-addr [number-of-collects <1-10>] response-ipv6-addr-text [number-of-collects <1-10>] response-name [number-of-collects <1-10>] response-rd-length [number-of-collects <1-10>] response- rdata [number-of-collects <1-10> width <1-128>] response-ttl [number-of-collects <1-10>] response-type [number-of-collects <1-10>] response-type-text [number-of-collects <1-10>]>	
Private	PEN <pen name>	HTTP	Response Code	Supported only for IPFIX.
Private	PEN <pen name>	HTTP	URL	Supported only for IPFIX. For width, the range is from 1 to 250.
Private	PEN <pen name>	HTTP	User Agent	Supported only for IPFIX. For width, the range is from 1 to 250.
Private	PEN <pen name>	SSL Certificate	<Issuer [width] Issuer Common Name [width] Serial Number Serial Number Text Signature Algorithm Signature Algorithm Text Subject [width] Subject Algorithm Subject Algorithm Text Subject Alternative Name [width]	Supported only for IPFIX. For width of Issuer and Subject, the range is from 1 to 250. For width of Issuer Common Name, Subject Alternative Name, and Subject Common Name, the range is from 1 to 64.

Collect Type	Parameters	Size		Description
			Subject Common Name [width] Subject Key Size Valid Not After Valid Not After Text Valid Not Before Valid Not Before Text>	
Private	PEN <pen name>	SSL Server	<Cipher Cipher Text Compression Method Name Indication [width] Session ID Version Version Text>	Supported only for IPFIX. For width, the range is from 1 to 64.
Private	PEN <pen name>	URL	[width]	Supported only for IPFIX. For width, the range is from 1 to 250.
timestamp	Sys-uptime First			Supported for v9 and IPFIX.
	Sys-uptime First Last			Supported for v9 and IPFIX.
transport	Destination Port			Supported for v9 and IPFIX.
	ICMP	IPv4 Code		Supported only for IPFIX.
		IPv4 Code Type		Supported only for IPFIX.
		ipv6 Code		Supported only for IPFIX.
		ipv6 Type		Supported only for IPFIX.
	Source Port			Supported for v9 and IPFIX.
	TCP Flags	[ACK] [CWR] [ECE] [FIN] [PSH] [RST] [SYN] [URG]		Supported for v9 and IPFIX.
	TCP	ACK Number		Supported only for IPFIX.
		Destination Port		Supported only for IPFIX.
		Header Length		Supported only for IPFIX.
		Sequence Number		Supported only for IPFIX.

Collect Type	Parameters	Size	Description
		Source Port	Supported only for IPFIX.
		Urgent Pointer	Supported only for IPFIX.
		Window Size	Supported only for IPFIX.
	UDP	Destination Port	Supported only for IPFIX.
		Message Length	Supported only for IPFIX.
		Source Port	Supported only for IPFIX.

GigaSMART Packet Slicing

Required License: Base

GigaSMART operations with a **Slicing** selected truncate packets after either a specified header/layer and offset (a **relative** offset) or at a specific offset. Slicing operations are typically configured to preserve specific packet header information, allowing effective network analysis without the overhead of storing full packet data.

Packets can have multiple variable-length headers, depending on where they are captured, the different devices that have attached their own headers along the way, and the protocols in use (for example, IPv4 versus IPv6). Because of this, slicing operations with a hard-coded offset will not typically provide consistent results.

To address this, the GigaSMART lets you configure packet slicing using **relative offsets** – a particular number of bytes after a specific packet header (IPv4, IPv6, UDP, and so on). The GigaSMART parses through Layer 4 (TCP/UDP) to identify the headers in use, slicing based on the variable offset identified for a particular header instead of a hard-coded number of bytes.

Keep in mind the following when configuring GigaSMART operations with a **Slicing** component:

Feature	Description
Protocol	<p>The following are the protocols that you can select for from the protocol drop-down list:</p> <ul style="list-style-type: none"> • IPV4 – Slice starting a specified number of bytes after the IPv4 header. • IPV6 – Slice starting a specified number of bytes after the IPv6 header. • UDP – Slice starting a specified number of bytes after the UDP header. • TCP – Slice starting a specified number of bytes after the TCP header. • FTP – Identify using TCP port 20 and slice payloads using offset from the TCP header.

Feature	Description
	<ul style="list-style-type: none"> • HTTPS – Identify using TCP port 443. Slice encrypted payloads using offset from the TCP header. • SSH – Identify using TCP port 22. Slice encrypted payloads using offset from the TCP header. <p>The GigaSMART can provide slicing for GTP tunnels, provided the user payloads are unencrypted. Both GTPv1 and GTPv2 are supported – GTP' (GTP prime) is not supported. Keep in mind that only GTP-u (user plane packets) are sliced. Control plane packets (GTP-c) are left unmodified because of their importance for analysis.</p> <ul style="list-style-type: none"> • GTP – Slice starting a specified number of bytes after the outer GTP header. • GTP-IPV4 – Slice starting a specified number of bytes after the IPv4 header inside the encapsulating GTP packet. • GTP-UDP – Slice starting a specified number of bytes after the UDP header inside the encapsulating GTP packet. • GTP-TCP – Slice starting a specified number of bytes after the TCP header inside the encapsulating GTP packet.
Slicing Offsets	<p>You can specify either a relative offset or a static offset for the start of the packet slice:</p> <ul style="list-style-type: none"> • Static offsets begin slicing a specific number of bytes from the start of the packet. Choose a static offset by setting protocol to none and supplying an offset from <64~9000> bytes. • Relative offsets begin slicing a specified number of bytes from the end of a particular header – IPv4, IPv6, and so on. Choose a relative offset by selecting any of the values listed for the protocol argument, along with an offset of <4~9000> bytes from the end of the specified layer:
Recalculated CRC	<p>GigaSMART packet slicing automatically calculates and appends a new four-byte Ethernet CRC based on the sliced packet's length and data and uses it to replace the existing CRC. This way, analysis tools do not report CRC errors for sliced packets.</p> <div data-bbox="435 1272 1455 1392" style="border: 1px solid #ccc; padding: 5px;"> <p>NOTE: The minimum relative offset is 4 bytes to allow the recalculated CRC to be added. The packet is sliced at the relative offset, and then the recalculated 4 bytes CRC is added to the sliced packet.</p> </div>
GigaSMART Trailer	<p>Slicing operations can optionally include the GigaSMART Trailer. If you do elect to include the GigaSMART Trailer, it will include the original packet length before slicing.</p> <div data-bbox="435 1493 1455 1577" style="border: 1px solid #ccc; padding: 5px;"> <p>NOTE: Refer to How to Use GigaSMART Trailers for details on when the GigaSMART Trailer is required for a GigaSMART Operation as well as the information found in it.</p> </div>
In Combination with Masking	<p>Slicing operations can be assigned to GigaSMART groups consisting of multiple engine ports. Refer to Groups of GigaSMART Engine Ports for details.</p>

Example – GigaSMART Packet Slicing

This example creates a GigaSMART slicing operation named **IPv6_Headers**. This operation truncates all packet data starting four bytes after the IPv6 header. The sliced packet would include the DLC, IPv6, and TCP headers, which are often enough for analysis needs.

The screenshot shows the configuration interface for GigaSMART Operations (GSOP). The 'Alias' field is set to 'IPv6_Headers'. The 'GigaSMART Groups' dropdown is set to 'gsgrp-1_4_e1'. The 'GigaSMART Operations (GSOP)' dropdown is empty. The 'Slicing' dropdown is expanded, showing 'IPv6' selected. Below it, the 'Offset' is set to '4'.

Figure 439: GigaSMART Operations (GSOP) Page with Slicing Selected

Display Slicing Statistics

To display slicing statistics, select **GigaSMART > GigaSMART Operations > Statistics**. The statistics for slicing will be in the row labeled Slicing in the GS Operations column.

Refer to [Slicing Statistics Definitions](#) for descriptions of these statistics as well as to [GigaSMART Operations Statistics Definitions](#).

GigaSMART Advanced Flow Slicing

Required License: Advanced Flow Slicing

Advanced Flow Slicing allows you to slice traffic on multiple network protocols, each with different offset. In Advanced Flow Slicing, you can configure multiple protocols within a profile with rules for slicing of a packet which in turn reduces the number of GigaSMART Operations (GSOP) and the maps to be configured. In this feature, the slicing of packets occurs after the packet count has reached a configured value thereby preventing the slicing of control information and other important data of the networking protocols.

Limitations

- Supports up to five enhanced profiles.
- Supports up to ten protocol rules for each profile.
- Slicing profile cannot be edited after attaching it to GSOP.
- Supports up to 80 million sessions per GigaSMART group.

Create Advance Flow Slicing Profile

To create an advance flow slicing profile, follow these steps:

1. Go to **Physical > Physical Nodes**.
2. Click the required cluster ID.
3. On the left navigation pane, go to **GigaSMART > Enhanced Slicing**. The Enhanced Slicing page appears.
4. Click **New**.
 - Enter an alias.
 - Enter the Maximum Sessions. In a profile, you can configure from 4 to 80 million sessions.
 - Select the Protocol from the drop-down list.
 - Choose the protocol type as Inner or Outer.
 - Enter the value for Offset. The value specifies the number of bytes that should be sliced after the protocol header. The value ranges from 64 to 9000, if there is no protocol selected. The value ranges from 0 to 9000 when other protocol is selected.
 - Select the Flow Session from the drop-down list. For a profile with flow-session defined, a session is created when a packet is received and when there is no existing flow-session for that flow.

Slicing or dropping starts on the next packet of a session after the number of packets reaches the specified value in the packet count.

- Choose either to Slice or Drop the session. The default action is Slice.

The slicing or drop occurs for the first matching rule in a profile.

- Enter the timeout sessions from 10 to 300 seconds. The default value is 30 seconds.
- Enter the Skip Packet Count value to slice or drop the packet after it reaches the given count value.

Each profile must have atleast one protocol field. You can add a maximum of 10 rules in a profile. Click + to add new rules in a profile.

5. Click **OK**.

Slicing or drop cannot be performed in the following conditions:

- When the traffic does not match any rule in the profile.
- When a packet does not contain the configured inner or outer IP and I4-port in a defined flow-session.

Example-GigaSMART Advanced Slicing

This example shown in creates a GigaSMART Advanced slicing operation named **eslice-gtpu**. In this operation, slicing occurs at HTTPS (port 443) over GTPu-TCP and GTPu-UDP traffic after 10 packets for each TLS connection. This operation truncates all packet data starting 40 bytes after the TCP header. The slicing starts after TCP header gets encapsulated by GTP.

ALIAS *	Maximum Sessions	
eslice-gtpu	5	
<hr/>		
+ - Protocol *	L4 Port	Offset *
GTPU TCP	443	40
<hr/>		
Flow Session	Timeout	Skip Packet Count
Inner	<input checked="" type="radio"/> Slice <input type="radio"/> Drop 200	10
<hr/>		
+ - Protocol *	L4 Port	Offset *
GTPU UDP	443	40
<hr/>		
Flow Session	Timeout	Skip Packet Count
Inner	<input checked="" type="radio"/> Slice <input type="radio"/> Drop 200	10

Figure 440: Enhanced Slicing

Display Slicing Statistics

To display Advanced Slicing statistics, select **GigaSMART** > **Enhanced Slicing** > **Statistics**. You can view the statistics of the Advanced Flow Slicing.

GigaSMART SSL Decryption for Inline and Out-of-Band Tools

Required License: SSL Decryption for Inline and Out-of-Band Tools

SSL decryption for inline and out-of-band tools is described in [Inline SSL Decryption](#). It is supported on all GigaVUE-HC1, GigaVUE-HC2, and GigaVUE-HC3 devices.

Configuring SSL Decryption Examples

Writer Comment: This section hidden until UI version of examples can be created.

The following sections provide examples of SSL decryption. Refer to the following:

- [Example 1: SSL Decryption with a Regular Map on page 613](#)
- [Example 2: SSL Decryption with De-Duplication on page 615](#)
- [Other Usage Examples on page 615](#)

Example 1: SSL Decryption with a Regular Map

In Example 1, a regular map is configured to use with the SSL decryption GigaSMART operation.

Step	Description	Command
1.	Upload a key and create a service. Refer to <i>Working with Keys and Services</i> on page 609.	(config) # apps ssl key alias key1 download type private-key url https://keyserver.domain.com/path/keyfile.pem (config) # apps ssl service alias service1 server-ip 192.168.1.1 server-port 443
2.	Configure a GigaSMART group..	(config) # gsgroup alias gsgrp1 port-list 1/1/e1
3.	Specify the GigaSMART group alias.	(config) # gsparams gsgroup gsgrp1
4.	Specify a failover action.	(config gsparams gsgroup gsgrp1) # ssl-decrypt decrypt-fail-action drop
5.	Configure session timeouts, in seconds.	(config gsparams gsgroup gsgrp1) # ssl-decrypt pending-session-timeout 60 (config gsparams gsgroup gsgrp1) # ssl-decrypt session-timeout 300 (config gsparams gsgroup gsgrp1) # ssl-decrypt tcp-syn-timeout 20
6.	Configure cache timeouts, in seconds.	(config gsparams gsgroup gsgrp1) # ssl-decrypt key-cache-timeout 9000 (config gsparams gsgroup gsgrp1) # ssl-decrypt ticket-cache-timeout 9000
7.	Configure a key/service mapping that maps how a key is assigned to an IP address of a server.	(config gsparams gsgroup gsgrp1) # ssl-decrypt key-map add service service1 key key1
8.	Enable SSL decryption.	(config gsparams gsgroup gsgrp1) # ssl-decrypt enable
9.	Exit the GigaSMART group configuration mode.	(config gsparams gsgroup gsgrp1) # exit (config) #
10.	Configure a GigaSMART operation for SSL decryption.	(config) # gsop alias gdssl1 ssl-decrypt in-port any out-port auto port-list gsgrp1

In the previous step, **gdssl1** is the alias for a GigaSMART operation, **in-port** specifies the destination port on which to listen, **out-port** specifies the destination port on which to send decrypted traffic, and **port-list** is set to the GigaSMART group alias previously configured. The **in-port** and **out-port** arguments can also be a port number between 1 and 65535.

Next, configure a traffic map, as follows:

Step	Description	Command
1.	Specify a map alias (m1) and specify the map type and subtype.	(config) # map alias m1 (config map alias m1) # type regular byRule
2.	Specify the GigaSMART operation alias (gdssl1) as part of the map. This applies the associated GigaSMART functionality to packets matching a rule in the map.	(config map alias m1) # use gsop gdssl1
3.	Specify a map rule.	(config map alias m1) # rule add pass ipver 4
4.	Specify the destination for packets matching this map.	(config map alias m1) # to 1/1/g2
5.	Specify the source port(s) for this map.	(config map alias m1) # from 1/1/g1
6.	Exit the map prefix mode.	(config map alias m1) # exit (config) #
7.	Display the configuration.	(config) # show gsop (config) # show map (config) # show gsparams

Example 2: SSL Decryption with De-Duplication

In Example 2, the configuration steps are the same except when you configure a GigaSMART operation you send the decrypted traffic to de-duplication for additional filtering, as follows:

```
(config) # gsop alias gdssl1 ssl-decrypt in-port any out-port auto dedup set port-list gsgrp1
```

Other Usage Examples

Two typical usage examples are as follows:

- Use map rules to filter on the IP address of the server and send everything to GigaSMART. Configure a GigaSMART operation to listen on the **in-port** used by the server. The GigaSMART will drop other traffic.
- Use map rules to filter on the IP address of the server and **in-port** and send specific port traffic to the GigaSMART. Configure a GigaSMART operation to listen on **in-port any**.

Inline SSL Decryption

This chapter describes SSL decryption for inline and out-of-band tools, referred to as inline SSL decryption. It provides introductory material as well as configuration examples for GigaVUE-FM. Refer to the following sections for details:

- [About Inline SSL Decryption](#)
- [Get Started with Inline SSL Decryption](#)

- [Configure Inline SSL Decryption](#)

About Inline SSL Decryption

This section introduces inline SSL decryption. Refer to the following sections for details:

- [SSL Decryption for Inline Tools](#)
- [What Inline SSL Decryption Provides](#)
- [Example Inline SSL Decryption](#)
- [Deploy Inline SSL Decryption](#)
- [GigaVUE Modules for Inline SSL Decryption](#)
- [Packet Flows](#)
- [Filter Traffic in GigaSMART](#)
- [SSL Sessions](#)
- [SSL Terminology and Acronyms](#)
- [Keys and Certificates](#)
- [Policy Profile](#)
- [Policy Evaluation](#)
- [Inline SSL Decryption Port Map](#)
- [Caches](#)
- [GigaSMART Overload Bypass](#)
- [Inline SSL Monitor Mode](#)
- [Inline Tool Configurations](#)

SSL Decryption for Inline Tools

SSL decryption for inline tools provides visibility into encrypted traffic. Inline SSL decryption delivers decrypted packets to tools that can be placed inline or out-of-band. The tools look into decrypted packets for threats, such as viruses or other malware.

The amount of Internet traffic that is encrypted is increasing, and much of it is encrypted with Secure Sockets Layer (SSL) or Transport Layer Security (TLS) protocols.

NOTE: Throughout this document, the terms Secure Sockets Layer (SSL) and Transport Layer Security (TLS) are used interchangeably.

Malware increasingly uses encrypted SSL traffic, thus a significant percentage of attacks hide in SSL. Inline SSL decryption offers visibility into encrypted applications and hidden threats in your organization.

Many applications, such as email, also use SSL. Encryption protects data from being viewed in transit over the Internet such as in an exchange of emails. Encryption also keeps the data private. But when data is encrypted, packets are not inspected, which can create blind spots in your network.

Providing visibility into encrypted traffic eliminates this blind spot. SSL/TLS blind spots in your network can be eliminated across any port or application, for example, port 443, or email, Web, or VoIP applications.

Inline SSL decryption differs from the existing GigaSMART SSL decryption application, which is passive. Out-of-band SSL decryption delivers decrypted traffic to out-of-band tools that can then detect threats entering the network. When a threat is detected, the tools can send a notification.

Inline SSL decryption offloads the decryption task so that tools can inspect traffic easily and effectively. The advantage of operating inline is that tools can act when a threat is detected.

Inline SSL decryption supports SSL version 3.0 and TLS versions 1.0, 1.1, and 1.2.

Also, the inline SSL decryption solution is able to decrypt Perfect Forward Secrecy (PFS) ciphers, for example, ECDHE-RSA-AES256-SHA384 and DHE-RSA-AES128-SHA256. Passive SSL decryption does not decrypt PFS ciphers.

What Inline SSL Decryption Provides

Inline SSL decryption provides the following:

- Identifies/detects encrypted traffic flows (SSL traffic) in a network across any port.
- Intercepts encrypted traffic flows between a client and a server.
- Filters encrypted traffic flows based on policy. For example, if the encrypted traffic flows contain health care or financial information, let those flows bypass decryption.
- Decrypts packets. Inline SSL decryption decrypts packets once at a single decryption point.
- Delivers decrypted traffic flows to multiple security tools. The tools can be inline or out-of-band. The tools can detect threats such as malware in the decrypted traffic flows.
- Re-encrypts traffic flows after receiving them back from the inline tools.
- If a tool acts on traffic flows based on the threats it finds, when malware is found in the decrypted traffic flows, the tool can:
 - modify the traffic flows
 - terminate the connection
- If the tool modifies the packets, GigaSMART will re-encrypt them. If the tool terminates the connection, GigaSMART will terminate the connection between the client and the server.

When SSL traffic is decrypted, sensitive data will be exposed in the connected tools. For example, if email traffic is decrypted, user passwords might be exposed or if financial data is decrypted, social security numbers might be exposed in the decrypted traffic.

Because SSL connections might carry sensitive data, not all connections should be inspected. Some of the SSL connections carrying user data such as financial or medical information should be bypassed without inspection, based on a configured policy.

Inline SSL decryption addresses acceptable use policies and adheres to privacy and compliance requirements. It offers advanced controls to select the traffic to decrypt.

Example Inline SSL Decryption

Refer to [Figure 441: Inline SSL Decryption Example, Outbound](#) for an example of inline SSL decryption.

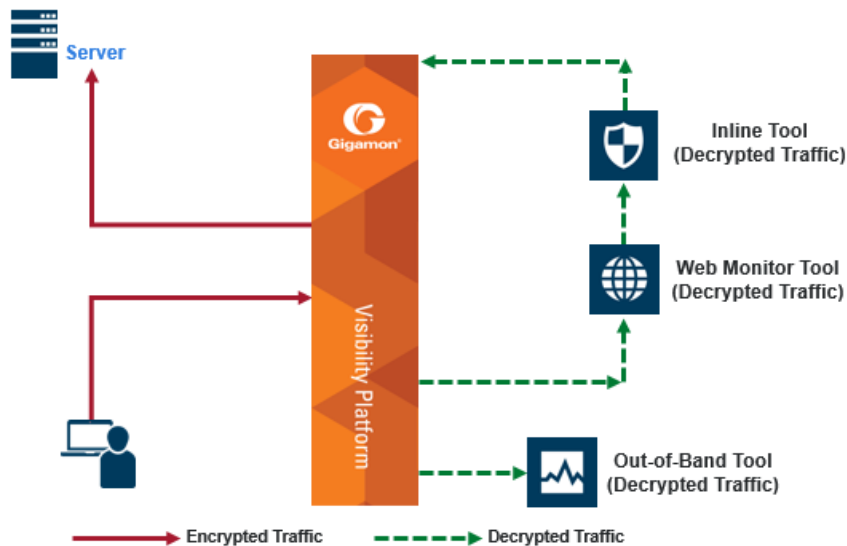


Figure 441: Inline SSL Decryption Example, Outbound

Use case for inline SSL decryption:

- Clients in internal network
- Servers on the Internet
- Organization does not have the private key of the server
- Diffie-Hellman and Perfect Forward Secrecy is being used

[Figure 441: Inline SSL Decryption Example, Outbound](#) shows the inline SSL decryption solution with the client and GigaVUE node within an enterprise. The server, in the top left of the figure, resides on the Internet. This is an example of an outbound deployment.

The client is on the lower left of the figure. The client is a user who is, for example, using a browser to go to a website on the Internet, such as a bank or a search engine. The traffic from the user could be encrypted or it might not be encrypted. For example, the user might be going to a bank website using the HTTPS protocol or going to a search engine website using the HTTP protocol. The solid line from the user to the GigaVUE node represents encrypted traffic, but there might also be traffic from the user that is not encrypted. Traffic that is not encrypted can either be bypassed or it can go to tools for inspection.

In [Figure 441: Inline SSL Decryption Example, Outbound](#), instead of the user interacting directly with the server at the top left, the GigaVUE node is placed in the middle. Thus, the GigaVUE node intercepts the client/server session.

In the GigaVUE node, encrypted packets are identified, then filtered. Selected packets are decrypted and sent to tools for inspection. The dotted lines represent decrypted packets. Packets are decrypted once, then the same decrypted packets can be sent to inline tools and/or out-of-band tools connected to the GigaVUE node.

The traffic from the inline tools is returned to the GigaVUE node to be re-encrypted and then sent to the destination on the Internet, for example, the website that the user is visiting. The solid line to the server represents traffic that has been re-encrypted in the GigaVUE node.

Deploy Inline SSL Decryption

There are two ways to deploy inline SSL decryption as follows:

- sessions are inbound
- sessions are outbound

Refer to [Figure 442: Inbound Deployment of Inline SSL Decryption](#) for an example of an inbound deployment. The client is on the Internet. The server and the GigaVUE node are located within the same enterprise network, with the GigaVUE node deployed on the server side. The GigaVUE node needs access to the private keys of the server to perform Man-in-the-Middle (MitM) decryption.

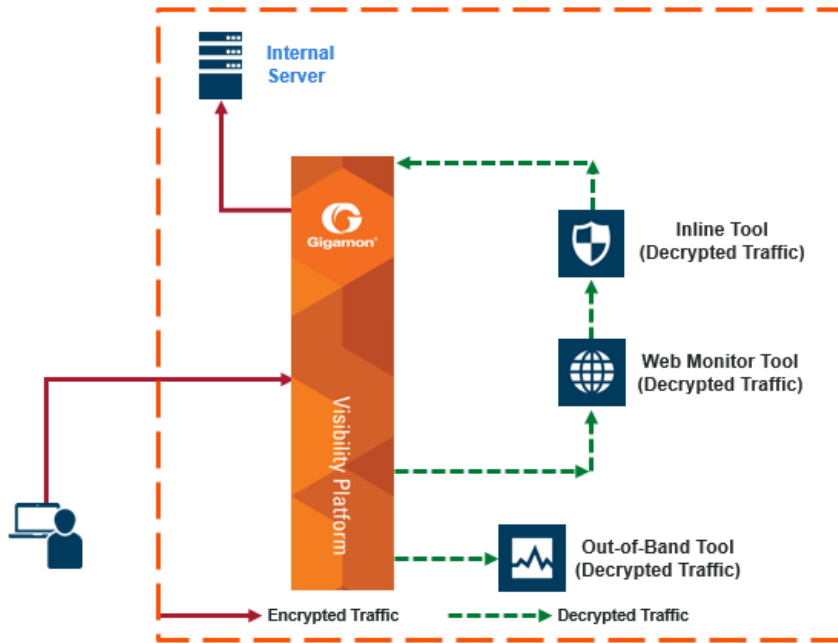


Figure 442: Inbound Deployment of Inline SSL Decryption

Use case for inline SSL decryption:

- Clients on the Internet
- Servers in internal network
- Organization has the private key of the server
- Diffie-Hellman and Perfect Forward Secrecy is being used

Refer to [Figure 443: Outbound Deployment of Inline SSL Decryption](#) for an example of an outbound deployment. The client and the GigaVUE node are located within the same enterprise network, with the GigaVUE node deployed on the client side. The server is located in another network on the Internet. In this deployment, the role of the GigaVUE node is that of a Man-in-the-Middle (MitM). In this deployment, the GigaVUE node does not have access to the private keys of the server, but as a trusted MitM, the GigaVUE node can look at SSL traffic.

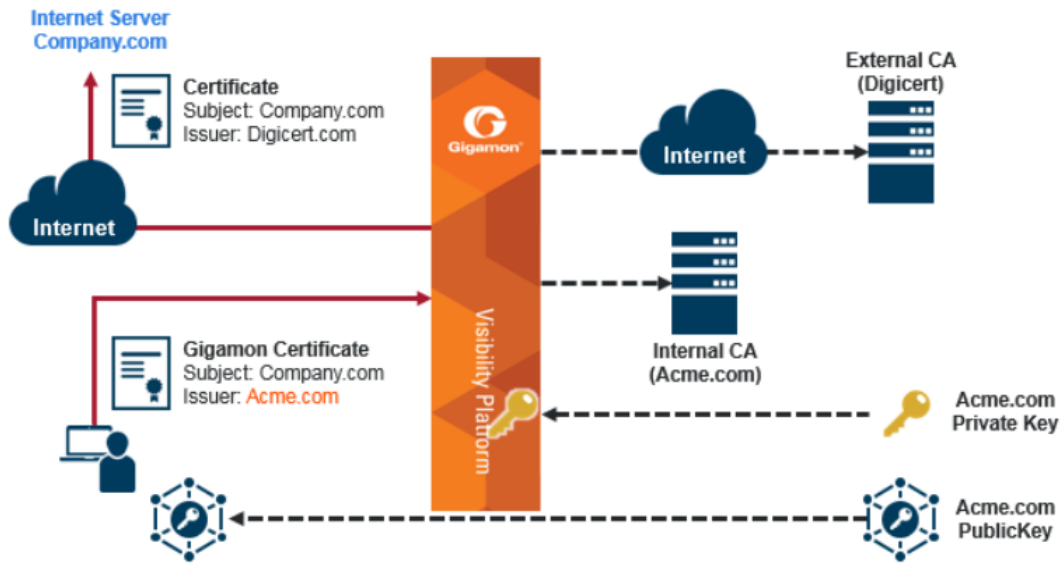


Figure 443: Outbound Deployment of Inline SSL Decryption

GigaVUE Modules for Inline SSL Decryption

Inline SSL decryption is supported on GigaVUE-HC1, GigaVUE-HC2, and GigaVUE-HC3 nodes, with the GigaSMART and inline bypass modules installed on the same node.

For physical inline bypass, install a fiber bypass (BPS) combo module. On GigaVUE-HC1 and GigaVUE-HC2, a copper TAP also supports physical bypass.

Table 65: [Inline Bypass Modules](#) lists the inline bypass modules.

Table 65: *Inline Bypass Modules*

GigaVUE Node	Description
GigaVUE-HC1	Bypass Combo Module 10Gb SX/SR (50/125µm multi-mode)
	Copper TAP module
GigaVUE-HC2	Bypass Combo Module 10Gb SX/SR (50/125µm multi-mode)
	Bypass Combo Module 10Gb SX/SR (62.5/125µm multi-mode)
	Bypass Combo Module 10Gb LX/LR (single mode)
	Bypass Combo Module 40Gb SR4 (multi-mode)
	Copper TAP module
GigaVUE-HC3	Bypass Combo Module 100Gb/40Gb SR4 MPO

Figure 444: GigaVUE Modules: GigaSMART and Inline Bypass shows a GigaVUE-HC2 with the GigaSMART module and the inline bypass (BPS) module. The GigaSMART module contains the SSL decryption software. The inline network ports are on the inline bypass module. The inline and out-of-band tool ports are on the same GigaVUE node.

For inline traffic, the inline network ports and the inline tool ports each need two links, called port pairs, for bidirectional traffic. For out-of-band (offline) traffic, only one link is needed, because the traffic is not bidirectional.

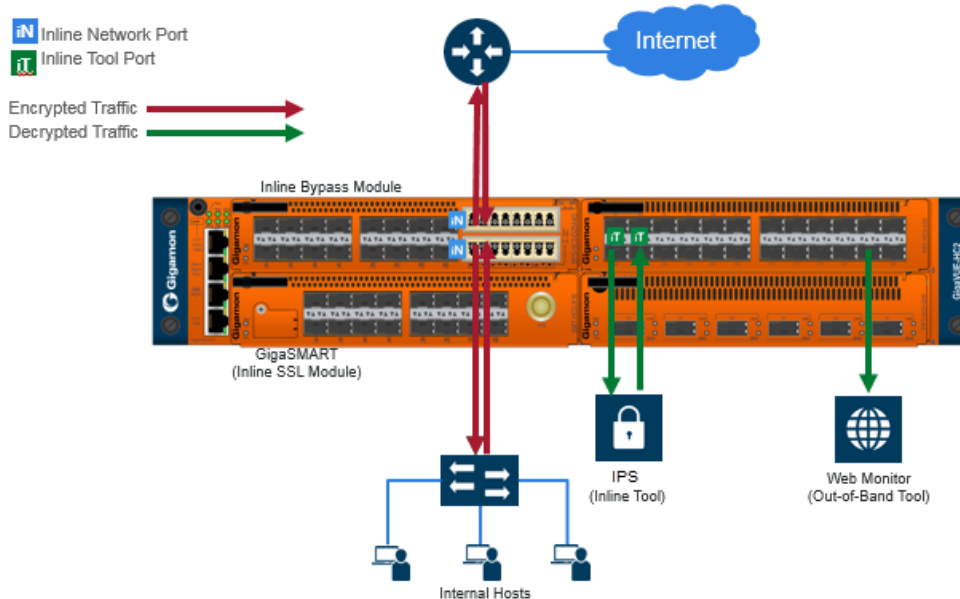


Figure 444: GigaVUE Modules: GigaSMART and Inline Bypass

Packet Flows

Normally, a client and server talk directly to each other, such as when you are using a browser to go to a bank website, a health care provider, or a search engine.

As shown in [Figure 443: Outbound Deployment of Inline SSL Decryption](#), the GigaVUE node is placed in the middle between the client and the server. All traffic from the Internet goes through the GigaVUE node.

Incoming traffic arrives on an ingress inline network port on the inline bypass module.

SSL traffic, which is TCP traffic, is directed to the GigaSMART module. Until the traffic is processed by the GigaSMART module, it is not known if it is SSL traffic or not.

The GigaSMART module decides what traffic is bypassed, what traffic is sent to tools without decryption, and what traffic is decrypted and then sent to tools. So, there are three types of decisions as follows:

- to bypass or not
- to decrypt or not
- to send to tools or not

Figure 445: Packet Flow for Inline SSL Decryption shows the flow for a configuration consisting of a single inline network, a single inline tool, and a single out-of-band tool.

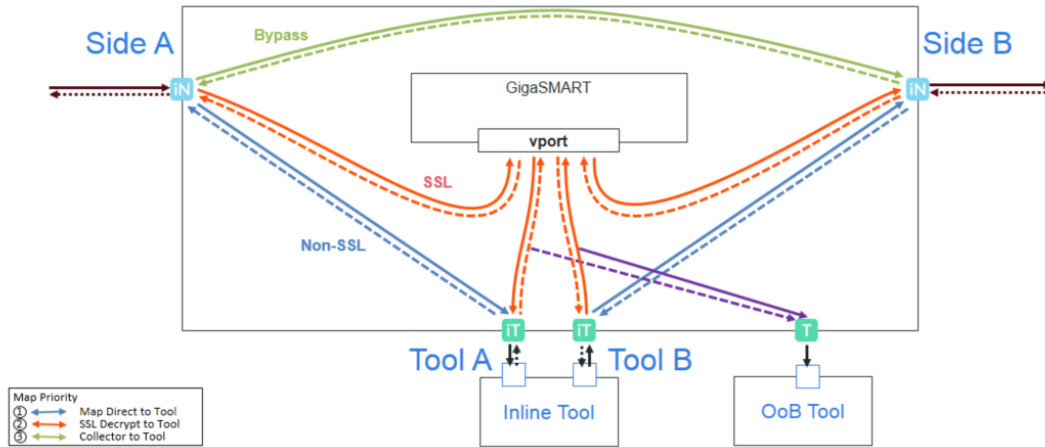


Figure 445: Packet Flow for Inline SSL Decryption

Traffic enters the inline SSL decryption solution at the side A inline network port on the inline bypass module.

Some traffic can be bypassed. That traffic goes from the side A inline network port to the side B inline network port on the inline bypass module as shown in the solid green line in [Figure 445: Packet Flow for Inline SSL Decryption](#). Bidirectional traffic is shown by dotted lines.

Traffic that is not encrypted (non-SSL) can be sent to tools for inspection. That traffic goes from the side A inline network port to the inline tool A port, to the inline tool, and from the inline tool to the inline tool B port and the side B inline network port on the inline bypass module without going through the GigaSMART module as shown in the solid blue lines in [Figure 445: Packet Flow for Inline SSL Decryption](#).

Traffic that is encrypted (SSL) goes from the side A inline network port on the inline bypass module to the GigaSMART module. That traffic goes to a virtual port (vport) that directs traffic to an inline SSL GigaSMART operation as shown by the red line on the left in [Figure 445: Packet Flow for Inline SSL Decryption](#). The traffic is decrypted in the GigaSMART module based on policy configuration, sent to the inline tool A port to the inline tool and from the inline tool to the inline tool B port, then back to the GigaSMART module for re-encryption as shown in the solid red lines in the center of

Figure 445: Packet Flow for Inline SSL Decryption. Finally, the re-encrypted traffic is sent from the GigaSMART module to the side B inline network port on the inline bypass module as shown by the red line on the right in [Figure 445: Packet Flow for Inline SSL Decryption](#).

The out-of-band tool can also receive the traffic as shown by the purple line on the right in [Figure 445: Packet Flow for Inline SSL Decryption](#).

Starting in software version 5.2, an out-of-band map from a virtual port to a single tool port is supported. Starting in software version 5.3.01, an out-of-band map from a virtual port to multiple tool ports is supported. The ports can be tool, hybrid, or GigaStream. Out-of-band maps from a vport to port groups are also supported when the ports in the group are tool or hybrid.

Modules Matrix

For traffic that is encrypted, there is a question as to whether or not it needs to be decrypted. For example, is there a policy for or against decrypting that traffic? There might be a policy, such as do not decrypt financial or health care traffic, or there might be a blacklist that states that traffic from a particular site should always be decrypted, or there might be a whitelist that states that traffic from a particular site should always be bypassed. So encrypted packets need to be filtered because some packets will not be decrypted, while others will be decrypted.

[Table 66: GigaVUE Modules Used for Type of Traffic](#) is a matrix of the GigaVUE module used for different types of traffic.

Table 66: GigaVUE Modules Used for Type of Traffic

Type of Traffic	GigaSMART	Inline Bypass	GigaSMART
Bypassing GigaSMART	No	Yes - to network	No
Not encrypted (non-SSL)	Yes	Yes - to tools then to network	Yes, depending on the configuration
Encrypted (SSL), and to be decrypted	Yes	Yes - to tools	Yes - to be re-encrypted, then to network

The GigaSMART module does the decryption as well as handling policies, whitelists, and blacklists. The decision to decrypt or not is made in the GigaSMART module.

Filter Traffic in GigaSMART

Because SSL/TLS connections can carry sensitive data, some organizations may require the SSL/TLS connections to avoid inspection. The SSL connections that carries user data such as financial or health care information can be bypassed without inspection, based on a configured policy.

Based on the decryption policies, some connections are not decrypted and are passed through, optionally to and through tools, without decryption. The inline SSL decryption solution respects data privacy and supports compliance.

Inline SSL decryption provides different ways to filter traffic, as follows:

- Whitelists specify traffic to always pass through. A whitelist policy states that traffic from certain sites should always skip decryption. Refer to [Whitelisting Policy](#).
- Blacklists specify traffic to always decrypt. A blacklist policy states that traffic from certain sites should always be decrypted. Refer to [Blacklisting Policy](#).
- URL Web Services categorizes the URLs by their type, such as MyBank.com is a financial institution, so as a policy, do not decrypt that traffic. This is also called URL filtering. Typically, banking and health care information are not decrypted. Refer to [URL Categorization](#).
- Policy rules based on network attributes, such as
 - Source IPv4 address
 - Destination IPv4 address
 - VLAN
 - L4 port

Whitelisting Policy

Whitelists are typically used in environments where the default is to decrypt, excepting for certain sites or classes of sites which cannot be decrypted for legal or compliance reasons. By default, traffic that is not to be decrypted is forwarded to the tools unless otherwise configured.

A whitelist file can contain a maximum of 10,000 entries.

Blacklisting Policy

Blacklisting is typically used at sites where specific classes of connections must be decrypted, although the default for other traffic is not to decrypt. Blacklisted domains and host names will always be decrypted.

A blacklist file can contain a maximum of 10,000 entries.

URL Categorization

URL categories make it convenient to apply policies on all the possible URLs by simplifying the number of policy rules. Categorization is based on the hostname in the TLS Server Name Indication (SNI) or the hostname from the server certificate if there is no SNI. There are 83 categories including one for Uncategorized, which is a default category for URLs that do not match any of the other 82 categories. The categories are fixed meaning that categories cannot be added, deleted or modified.

GigaSMART ships with a local database of 1M entries and will also perform a cloud lookup for those hosts not found in the local database. The URL Web Service provides the URL categorization. The URL database is updated daily from the URL Web Service. Each update likely adds new entries and purges other entries, but always keeping the database at 1M entries.

NOTE: When a URL is not in the cache, for cloud look-ups the stack port interface on GigaSMART must be configured to provide Internet access. Refer to [Configure Stack Port Interface](#) for more information.

URL Look-ups and Caching

As part of the iSSL processing, URL look-ups are performed against the database. If the URL is not found in the database, then a lookup is performed against the local cache. If the URL is not found in the local cache, then an external lookup to the URL Web Services may be performed, if configured. If the URL is found in the external look-up, then it is dynamically saved in the local cache. Future look-ups may then find the URL in the local cache instead of requiring the external look-up.

The local cache can hold up to 250k entries (in addition to the 1M entry database). The local cache works like a circular buffer – older entries are discarded to make room for newer ones if the cache is full. Each cache entry is valid for 24 hours and updated with current time stamp whenever an entry is made. If an expired entry is encountered, a new query is issued to the URL Web Services to refresh the entry in the cache. Expired entries don't get actively deleted from the cache.

While the URL Web Service is hosted on AWS, external look-ups need to occur very quickly. Gigamon provides a timeout option, up to 10 seconds for external URL look-ups via the URL cache miss defer option.

NOTE:

- URLs may get recategorized as part of updates from the URL Web Services. This is transparent to Gigamon and customers.
- The URL category classification is fixed, and a new category cannot be added. Gigamon provides the whitelist/blacklist functionality, which can achieve the same result as creating a custom category.
- If a URL belongs to multiple categories, any no-decrypt policy would take precedence over all decrypt policies.

Inline SSL URL categories

The following are the list of Inline SSL URL categories with examples.

NOTE: Gigamon does not endorse any of the following categories, descriptions, and examples, but replicated the information from the URL Web Services. Some categories are presented without examples since they are not appropriate.

Category Name	Description and Examples
Abortion	Abortion topics, either pro-abortion and anti-abortion.
Abused Drugs	Discussion or remedies for illegal, illicit, or abused drugs such as heroin, cocaine, or other street drugs. This category includes information on the misuse of non-proscribed substances (eg. "glue sniffing"), or the misuse of prescription medications.
Adult and Pornography	Sexually explicit material for the purpose of arousing a sexual or prurient interest. Online groups, including newsgroups and forums, that are sexually explicit in nature.
Alcohol and Tobacco	Sites that provide information on, promote, or support the sale of alcoholic beverages or tobacco products and associated paraphernalia.
Auctions	Sites that support the offering and purchasing of goods between individuals as their main purpose. Does not include classified advertisements. <ul style="list-style-type: none"> • http://ebay.co • http://quibids.com

Category Name	Description and Examples
Botnets	These are URLs, typically IP addresses, which are determined to be part of a Bot network, from which network attacks are launched. Attacks may include SPAM messages, DOS, SQL injections, proxy jacking, and other unsolicited contacts.
Business and Economy	Business firms, corporate websites, business information, economics, marketing, management, and entrepreneurship. <ul style="list-style-type: none"> • http://samsung.com • http://ups.com
Content Delivery Networks	Delivery of content and data for third parties, including ads, media, files, images, and video. <ul style="list-style-type: none"> • http://metacdn.co • http://edgestream.com
Cheating	Sites that support cheating on examinations and contain such materials, including free essays, exam copies, plagiarism, etc.
Computer and Internet Info	General computer and Internet sites, technical information. SaaS sites and other URLs that deliver internet services. <ul style="list-style-type: none"> • http://ranking.co • http://system.netsuite.com
Computer and Internet Security	Computer/Internet security, security discussion groups. <ul style="list-style-type: none"> • http://siteadvisor.co • http://webroot.com
Confirmed Spam Sources	Confirmed SPAM sources.
Cult and Occult	Internet resources which include discussion of astrology, spells, curses, magical powers, satanic rituals or supernatural beings. This includes horoscope sites.
Dating	Dating websites focused on establishing personal relationships. <ul style="list-style-type: none"> • http://eharmony.com
Dead Sites	These are dead sites that do not respond to http queries. Policy engines should usually treat these as "Uncategorized" sites. <ul style="list-style-type: none"> • http://g00gle.com • http://whitehouse.info

Category Name	Description and Examples
Dynamic Content	<p>Domains that generate content dynamically based on arguments to their URL or other information (like geo-location) on the incoming web request.</p> <ul style="list-style-type: none"> • booking.com
Education Institution	<p>Pre-school, elementary, secondary, high school, college, university, and vocational school and other educational content and information including enrollment, tuition, and syllabus.</p> <ul style="list-style-type: none"> • http://mit.edu • http://ox.ac.uk
Entertainment and Arts	<p>Motion pictures, videos, television, music and programming guides, books, comics, movie theatres, galleries, artists or reviews on entertainment.</p> <ul style="list-style-type: none"> • http://eonline.com • http://warnerbros.com
Fashion and Beauty	<p>Fashion or glamour magazines, beauty, clothes, cosmetics, style.</p> <ul style="list-style-type: none"> • http://visionmodels.co.uk • http://genejuarez.com
Financial Services	<p>Banking services and other types of financial information, such as loans, accountancy, actuaries, banks, mortgages, and general insurance companies. Does not include sites that offer market information, brokerage or trading services.</p> <ul style="list-style-type: none"> • http://firstpremierbankcards.com • http://paypal.com
Gambling	<p>Gambling or lottery web sites that invite the use of real or virtual money. Information or advice for placing wagers, participating in lotteries, gambling, or running numbers. Virtual casinos and offshore gambling ventures. Sports picks and betting pools.</p>
Games	<p>Playing or downloading, video games, computer games, electronic games, tips, and advice on games or how to obtain cheat codes. Also includes sites dedicated to selling board games as well as journals and magazines dedicated to game playing.</p> <ul style="list-style-type: none"> • http://duowan.com • http://ubi.com

Category Name	Description and Examples
Government	<p>Information on government, government agencies and government services such as taxation, public, and emergency services. Also includes sites that discuss or explain laws of various governmental entities. Includes local, county, state, and national government sites.</p> <ul style="list-style-type: none"> • http://www.nasa.gov • http://premier-ministre.gouv.fr
Gross	<p>Sites that contain material which describe or display material which would be considered foul or disgusting. Examples would include bodily fluids, injuries, gore.</p>
Hacking	<p>Illegal or questionable access to or the use of communications equipment/software. Development and distribution of programs that may allow compromise of networks and systems.</p>
Hate and Racism	<p>Sites that contain content and language in support of hate crimes and racism.</p>
Health and Medicine	<p>General health, fitness, well-being, including traditional and non-traditional methods and topics. Medical information on ailments, various conditions, dentistry, psychiatry, optometry, and other specialties.</p> <ul style="list-style-type: none"> • http://webmd.com • http://missionvalleymedical.com
Home and Garden	<p>Home issues and products, including maintenance, home safety, decor, cooking, gardening, home electronics, design, etc.</p> <ul style="list-style-type: none"> • http://homedepot.com • http://waysidegardens.com
Hunting and Fishing	<p>Sport hunting, gun clubs, and fishing.</p> <ul style="list-style-type: none"> • http://fishingworks.com • http://wildlifelicense.com
Illegal	<p>Criminal activity, copyright and intellectual property violations, etc.</p>
Image and Video Search	<p>Photo and image searches, online photo albums/digital photo exchange, image hosting.</p> <ul style="list-style-type: none"> • http://images.google.fr • http://gettyimages.com
Individual Stock Advice	<p>Promotion and facilitation of securities trading and management of</p>

Category Name	Description and Examples
and Tools	investment assets. Also includes information on financial investment strategies, quotes, and news. <ul style="list-style-type: none"> • http://stockstar.com • http://morningstar.com
Internet Com- munications	Internet telephony, messaging, VoIP services and related businesses. <ul style="list-style-type: none"> • http://skype.com • http://www.chatib.com/
Internet Portals	Web sites that aggregate a broader set of Internet content and topics, and which typically serve as the starting point for an end user. <ul style="list-style-type: none"> • http://yahoo.com • http://qq.com
Job Search	Assistance in finding employment, and tools for locating prospective employers, or employers looking for employees. <ul style="list-style-type: none"> • http://monster.com • http://51job.com
Keyloggers and Mon- itoring	Downloads and discussion of software agents that track a user's key-strokes or monitor their web surfing habits.
Kids	Sites designed specifically for children and teenagers. <ul style="list-style-type: none"> • http://www.mundogaturro.com • http://www.poptropica.com
Legal	Legal websites, law firms, discussions and analysis of legal issues. <ul style="list-style-type: none"> • http://www.pepperlaw.com • http://earlcaterlaw.com
Local Information	City guides and tourist information, including restaurants, area/regional information, and local points of interest. <ul style="list-style-type: none"> • http://downtownlittlerock.com • http://sandiegorestaurants.com
Malware Sites	Malicious content including executables, drive-by infection sites, malicious scripts, viruses, trojans, and code.
Marijuana	Marijuana use, cultivation, history, culture, legal issues.
Military	Information on military branches, armed services, and military history. <ul style="list-style-type: none"> • http://defense.gov

Category Name	Description and Examples
	<ul style="list-style-type: none"> • http://www.mod.uk
Motor Vehicles	<p>Car reviews, vehicle purchasing or sales tips, parts catalogs. Auto trading, photos, discussion of vehicles including motorcycles, boats, cars, trucks and RVs. Journals and magazines on vehicle modifications.</p> <ul style="list-style-type: none"> • http://www.carmax.com • http://carsales.com.au
Music	<p>Music sales, distribution, streaming, information on musical groups and performances, lyrics, and the music business.</p> <ul style="list-style-type: none"> • http://itunes.com • http://bandcamp.com
News and Media	<p>Current events or contemporary issues. Also includes radio stations, magazines, online newspapers, headline news sites, newswire services, personalized news services, and weather sites.</p> <ul style="list-style-type: none"> • http://abcnews.go.com • http://newsoftheworld.co.uk
Nudity	<p>Nude or seminude depictions of the human body. These depictions are not necessarily sexual in intent or effect but may include sites containing nude paintings or photo galleries of artistic nature.</p>
Online Greeting Cards	<p>Online Greeting card sites.</p> <ul style="list-style-type: none"> • http://123greetings.com • http://greeting-cards.com
Online Personal Storage	<p>Online storage and posting of files, music, pictures, and other data.</p> <ul style="list-style-type: none"> • http://box.net • http://freefilehosting.net
Open HTTP Proxies	<p>The proxy servers that are accessible by any Internet user.</p>
P2P (Peer to Peer)	<p>Peer to peer clients and access that includes torrents, music download and programs.</p>
Parked Sites	<p>Parked domains are URLs which host limited content or click-through ads which may generate revenue for the hosting entities but generally do not contain content useful to the end user. Also includes Under Construction, folders, and web server default home pages.</p> <ul style="list-style-type: none"> • http://000.com

Category Name	Description and Examples
	<ul style="list-style-type: none"> • http://buythisdomain.com
Pay to Surf	Sites that pay users in the form of cash or prizes, for clicking on or reading specific links, email, or web pages.
Personal Sites and Blogs	Personal websites posted by individuals or groups, as well as blogs. <ul style="list-style-type: none"> • http://blogger.com • http://wordpress.org
Philosophy and Political Advocacy	Politics, philosophy, discussions, promotion of a particular viewpoint or stance in order to further a cause. <ul style="list-style-type: none"> • http://philosophynow.org • http://political.com
Phishing and Other Frauds	Phishing, pharming, and other sites that pose as a reputable site, usually to harvest personal information from a user. These sites are typically quite short-lived, so examples may not last long.
Private IP Addresses	RFC 1918, Address Allocation for Private Intranets. 10.0.0.0 - 10.255.255.255 (10/8 prefix) 192.168.0.0 - 192.168.255.255 (192.168/16 prefix)
Proxy Avoid and Anonymizers	Proxy servers and other methods to gain access to URLs in any way that bypasses URL filtering or monitoring. Web-based translation sites that circumvent filtering.
Questionable	Tasteless humor, "get rich quick" sites, and sites that manipulate the user experience or client in some unusual, unexpected, or suspicious manner.
Real Estate	Information on renting, buying, or selling real estate or properties. Tips on buying or selling a home. Real estate agents, rental or relocation services, and property improvement. <ul style="list-style-type: none"> • http://prudentialproperties.com • http://realtor.com
Recreation and Hobbies	Information, associations, forums and publications on recreational pastimes such as collecting, kit airplanes, outdoor activities such as hiking, camping, rock climbing, specific arts, craft, or techniques; animal

Category Name	Description and Examples
	<p>and pet related information, including breed-specifics, training, shows and humane societies.</p> <ul style="list-style-type: none"> • http://petloverspublications.com • http://craftster.org
Reference and Research	<p>Personal, professional, or educational reference material, including online dictionaries, maps, census, almanacs, library catalogues, genealogy, and scientific information.</p> <ul style="list-style-type: none"> • http://reference.com • http://wikipedia.org
Religion	<p>Conventional or unconventional religious or quasi-religious subjects as well as churches, mosques, synagogues, or other places of worship.</p> <ul style="list-style-type: none"> • http://therocksandiego.org • http://biblesociety.ca
Search Engines	<p>Search interfaces using key words or phrases. Returned results may include text, websites, images, videos, and files.</p> <ul style="list-style-type: none"> • http://google.com • http://sogou.com
Sex Education	<p>Information on reproduction, sexual development, safe sex practices, sexually transmitted diseases, sexuality, birth control, sexual development, and contraceptives.</p> <ul style="list-style-type: none"> • http://sexetc.org
Shareware and Free-ware	<p>Sites that contains softwares, screensavers, icons, wallpapers, utilities, ringtones including downloads that request a donation on open source projects.</p> <ul style="list-style-type: none"> • http://download.com • http://sourceforge.net
Shopping	<p>Department stores, retail stores, company catalogs and other sites that allow online consumer or business shopping to purchase goods and services.</p> <ul style="list-style-type: none"> • http://amazon.com • http://groupon.com
Social Network	<p>Social networking sites that have user communities where users interact, post messages, pictures, and otherwise communicate.</p>

Category Name	Description and Examples
	<ul style="list-style-type: none"> • http://facebook.com • http://twitter.com
Society	<p>A variety of topics, groups, and associations relevant to the general populace, broad issues that impact a variety of people, including safety, children, societies, and philanthropic groups.</p> <ul style="list-style-type: none"> • http://dar.org • http://unicefusa.org
Spam URLs	URLs contained in SPAM.
Sports	<p>Team or conference web sites, international, national, college, professional scores and schedules; sports-related online magazines or newsletters, fantasy sports and virtual sports leagues.</p> <ul style="list-style-type: none"> • http://nba.com • http://schoenen-dunk.de
Spyware and Adware	<p>Spyware or Adware sites that provide or promote information gathering or tracking that is unknown to, or without the explicit consent of, the end user or the organization, also unsolicited advertising popups and programs that may be installed on a user's computer.</p>
Stream Media	<p>Sales, delivery, or streaming of audio or video content, including sites that provide downloads for such viewers.</p> <ul style="list-style-type: none"> • http://youtube.com • http://ustream.tv
Swimsuits and Intimate Apparel	Swimsuits, intimate apparel or other types of suggestive clothing.
Training and Tool	<p>Distance education, trade schools, online courses, vocational training, software training, and skills training.</p> <ul style="list-style-type: none"> • http://trainingtools.com • http://prezi.com
Translation	<p>Language translation sites that allow users to see URL pages in other languages.</p> <ul style="list-style-type: none"> • http://translate.google.com • http://microsofttranslator.com
Travel	Airlines and flight booking agencies. Travel planning, reservations,

Category Name	Description and Examples
	vehicle rentals, car rentals, descriptions of travel destinations, promotions for hotels or casinos. <ul style="list-style-type: none"> • http://cheapflights.com • http://expedia.com
Uncategorized	Sites that have not been categorized by URL Web Service.
Unconfirmed Spam Sources	Unconfirmed SPAM sources.
Violence	Sites that advocate violence, depictions and methods, including game/-comic violence, and suicide.
Weapons	Sales, reviews, descriptions of weapons such as guns, knives, martial arts accessories.
Web Advertisements	Advertisements, media, content, and banners. <ul style="list-style-type: none"> • http://casalemedia.com • http://justwebads.com
Web Based Email	Sites offering web-based email and email clients. <ul style="list-style-type: none"> • http://google.com/mail • http://foxmail.com
Web Hosting	Free or paid hosting services for web pages and information concerning their development, publication, and promotion. <ul style="list-style-type: none"> • http://siteground.com • http://bluehost.com

SSL Sessions

Secure Sockets Layer (SSL) is a protocol that allows the transmission of secure data between a server and client. Transport Layer Security (TLS) is a cryptographic protocol that adds security to TCP/IP communication.

Inline SSL decryption supports SSL version 3.0 and TLS versions 1.0, 1.1, and 1.2.

TLS and SSL are used in communications such as Web browsing, email, instant messaging, and voice over IP (VoIP). TLS and SSL encrypt these communications.

The client initiates the SSL session. The GigaVUE node intercepts the connection and negotiates an SSL session with the client.

The GigaVUE node monitors all TCP connections, then intercepts the SSL session. Non-TCP traffic is passed transparently without any changes.

All the incoming SSL traffic terminates on the GigaVUE node. The SSL connections are decrypted in inbound or outbound deployments, passed to the inline tools, and eventually to the server.

The session to the client is terminated on the GigaVUE node, but information about the session, such as the initiator's IP address is maintained, so that the GigaVUE node can "reconnect" the client and server.

The GigaVUE node performs SSL decryption and feeds tools, either inline or out-of-band.

The session to the server is from the GigaVUE node to the server. The GigaVUE node negotiates a new SSL session with the server.

SSL Handshake

SSL encryption secures traffic between a client and a server, such as a Web server. SSL decryption uses keys to decode the traffic between the client and server.

SSL and Transport Layer Security (TLS) protocols consist of a set of messages exchanged between a client and server to set up and tear down the SSL connection between them. To set up the connection, the client and server use the Public Key Infrastructure (PKI) to exchange the bulk encryption keys needed for data transfer.

[Figure 446: Basic SSL Handshake](#) shows the basic SSL handshake between a client and server to establish a session.

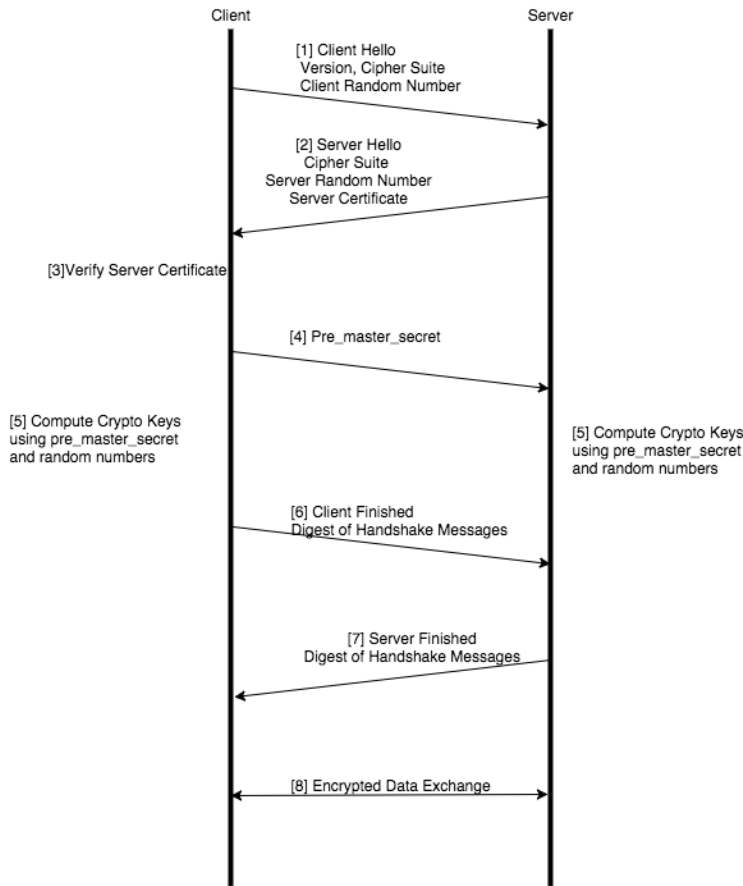


Figure 446: Basic SSL Handshake

SSL Handshake Steps

The SSL handshake steps in [Figure 446: Basic SSL Handshake](#) are as follows:

1. The SSL or TLS client sends a Client Hello message that contains information such as the SSL or TLS version and the list of cipher suites supported by the client. The message also contains a client random number.
2. The SSL or TLS server responds with a Server Hello message that contains the SSL or TLS version it supports and the cipher suite chosen by the server from the list provided by the client, and a server random number. The server also sends its digital certificate.
3. The SSL or TLS client verifies the server's digital certificate.
4. Using the random numbers from the Hello messages, the SSL or TLS client computes the pre_master_secret that enables both the client and the server to compute the secret key to be used for encrypting subsequent message data. The pre_master_secret is encrypted with the server's public key and sent.
5. The SSL or TLS server verifies the client's certificate.

6. The SSL or TLS client sends the server a Client Finished message containing a digest (MAC) of the messages in the handshake, which is encrypted with the secret key, indicating that the client part of the handshake is complete.
7. The SSL or TLS server sends the client a Server Finished message containing a digest (MAC) of the messages in the handshake, which is encrypted with the secret key, indicating that the server part of the handshake is complete.
8. For the duration of the SSL or TLS session, the server and client can now exchange messages that are symmetrically encrypted with the shared secret key.

Figure 447: Man-in-the-Middle SSL Handshake shows the SSL handshake when a Man-in-the-Middle sits between the client and server.

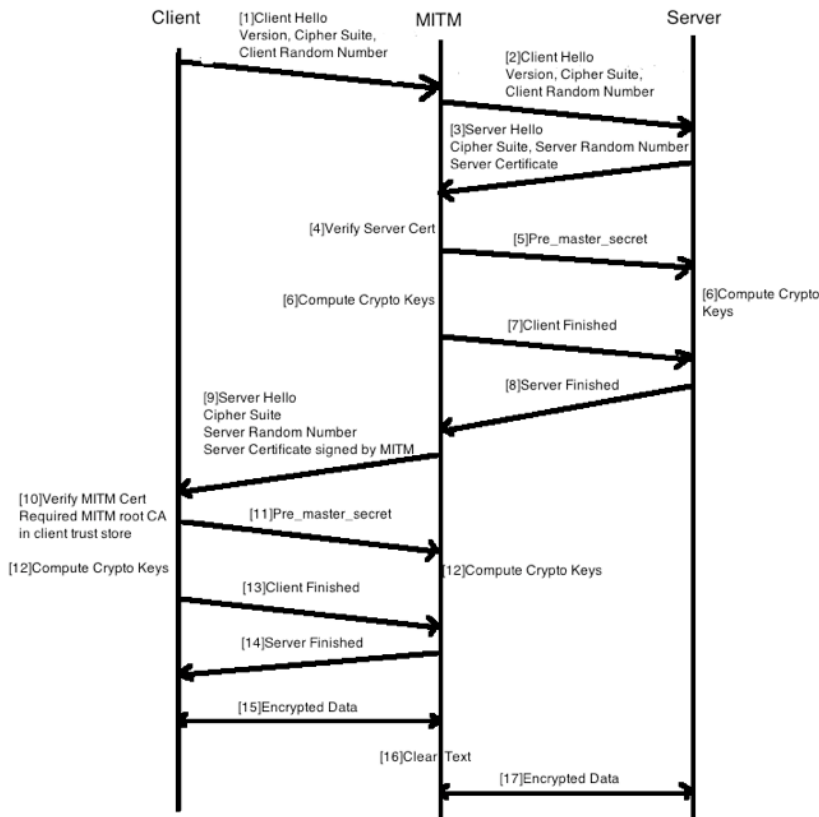


Figure 447: Man-in-the-Middle SSL Handshake

SSL Session, Inbound Deployment

Figure 442: Inbound Deployment of Inline SSL Decryption shows an inline SSL decryption inbound deployment. The client is on the Internet. The server and the GigaVUE node are located within the same enterprise network, with the GigaVUE node deployed on the server side. The GigaVUE node needs access to the private keys of the server.

The SSL session is created as follows:

1. Client traffic, such as from the Internet, arrives on an inline-network port on the GigaVUE node and establishes a TCP connection.
2. The GigaVUE node initiates a TCP connection to the server.
3. Gigamon establishes the SSL handshake with the server parameters from the SSL client's Hello request.
4. Gigamon establishes the SSL handshake with the client using the server's certificate and key, and using the appropriate parameters.

SSL Session, Outbound Deployment

Figure 443: Outbound Deployment of Inline SSL Decryption shows an inline SSL decryption outbound deployment. The client is in your network, and it connects to a server outside your network on the Internet. Traffic is destined to servers where you not have access to the private keys.

The SSL session is created as follows:

1. Client traffic, such as from an employee on the enterprise's Intranet is destined to a server on the Internet. The traffic arrives on a network port on the GigaVUE node.
2. Gigamon initiates a new connection to the server as the client.
3. The server responds with its server certificate and presents it to Gigamon.
4. Gigamon spoofs the server certificate and presents it to the client, but now the certificate is signed by Gigamon.
5. The end client verifies that the certificate is valid as it belongs to the server and has been signed by Gigamon, which has been listed as one of the valid CAs.
6. Gigamon now maintains two TCP connections, one with the client and one with the server.

SSL Session Resumption

SSL sessions can be resumed to improve performance. SSL session resumption speeds up the SSL handshake.

Once a session has been established, the keys are saved so a session can be resumed efficiently later. The resumed SSL handshake has fewer steps.

Session identifier-based resumption is supported. The GigaVUE node maintains the session identifier data in the cache. Session ticket-based resumption is not supported.

By default, resumption is enabled.

SSL Session Search

Starting in software version 5.2, you can search an existing session based on a hostname. The input is matched against the Server Name Indication (SNI) or the certificate subject name of the current sessions.

StartTLS

StartTLS provides a mechanism for protocols such as SMTP, IMAP, and POP3 to start in plaintext mode and upgrade to encrypted mode on the existing port instead of using another port.

The StartTLS command is initiated from the client or the server. Upon receiving a response from either end, TLS handshake messages are exchanged between the client and the server.

To support StartTLS, the GigaVUE node monitors the TCP connections for protocols, such as SMTP, IMAP, and POP3. Upon detecting the StartTLS message on a port, the processing of packets for decryption can start.

Starting in software version 5.2, the specific ports to monitor StartTLS traffic must be specified. Up to 20 ports can be monitored.

Inline SSL Decryption Behavior with StartTLS

For connections that use StartTLS to upgrade from non-TLS mode to secure mode, the inline SSL decryption solution decrypts correctly if the decision to decrypt or not is made in the certificate phase.

If the CLIENT HELLO packet does not have SNI information, the inline SSL decryption solution will apply policy rules in certificate phase of the policy evaluation.

For explicit proxy connections policy, rules are applied in certificate phase of policy evaluation. For information on the certificate phase of policy evaluation, refer to [Policy Evaluation](#).

NOTE: You need to enable StartTLS for decryption sessions established through explicit proxy.

SSL Terminology and Acronyms

[Table 67: SSL Terminology](#) provides definitions of SSL terminology:

Table 67: SSL Terminology

Term	Definition
Plaintext	The original, unencrypted data.
Ciphertext	The encrypted data.
Cryptography	The practice of secure communications.
Encryption	The process of turning plaintext into ciphertext.
Decryption	The process of turning ciphertext into plaintext.
Encryption algorithm	The algorithm used to perform encryption and decryption. It is also called the cipher.
Encryption key	The key used for encryption.
Decryption key	The key used for decryption.
Symmetrical encryption algorithm	The algorithm used for encryption in which the encryption key and the decryption key are identical.
Asymmetrical encryption algorithm	The algorithm used for encryption in which the encryption key and the decryption key are different.
Public key	The key used for encryption.
Private key	The key used for decryption.

Table 68: SSL Acronyms lists SSL acronyms:

Table 68: SSL Acronyms

Acronym	Definition
AES	Advanced Encryption Standard
CA	Certificate Authority
CBC	Cipher Block Chaining
CN	Common Name
CRL	Certificate Revocation List
DES	Data Encryption Standard
DH, D-H	Diffie-Hellman
DSA	Digital Signature Algorithm
ECDH	Elliptic Curve Diffie-Hellman

Acronym	Definition
ECDSA	Elliptic Curve Digital Signature Algorithm
FQDN	Fully Qualified Domain Name
IDS	Intrusion Detection System
IPS	Intrusion Prevention System
MAC	Message Authentication Code
MD	Message Digest
MitM	Man-in-the-Middle
OCSP	Online Certificate Status Protocol
OoB	Out-of-Band
PEM	Privacy Enhanced Mail
PFS	Perfect Forward Secrecy
PKCS12	Public Key Cryptography Standard #12
PKI	Public Key Infrastructure
RSA	Rivest-Shamir-Adleman
SHA	Secure Hash Algorithm
SSL	Secure Sockets Layer
TCP	Transmission Control Protocol
TLS	Transport Layer Security
URL	Uniform Resource Locator

Keys and Certificates

The SSL protocol allows the transmission of secure data between a server and client who both have the keys to decode the transmission and the certificates to verify trust between them.

An SSL certificate is a digital document containing a public key, host information, and a digital signature from the certificate issuer, known as a Certificate Authorities (CAs). The certificate allows trust to be established between two communicating endpoints.

The inline SSL decryption solution has a trust store, which is a collection of certificates of CAs. Gigamon only trusts server certificates that have a trust anchor in the configured trust store, in other words, if the certificate chain can be built with one of the root CAs in the trust store. Gigamon ships with a default trust store, which you can replace.

The inline SSL decryption solution acts as a Man-in-the-Middle (MitM). In the outbound deployment case, the MitM generates server certificates on-the-fly signed by the installed Signing CA. In the inbound deployment case, server certificate generation is not needed but the server's private key and certificate chain need to be made available to the MitM.

The inline SSL decryption solution also has a key store, which is a collection of SSL private keys (for inbound deployments) and SSL certificates and corresponding private keys that are used to digitally sign the emulated server certificates (for outbound deployments).

Figure 448: Sample Certificate shows a sample certificate and its relevant parts.

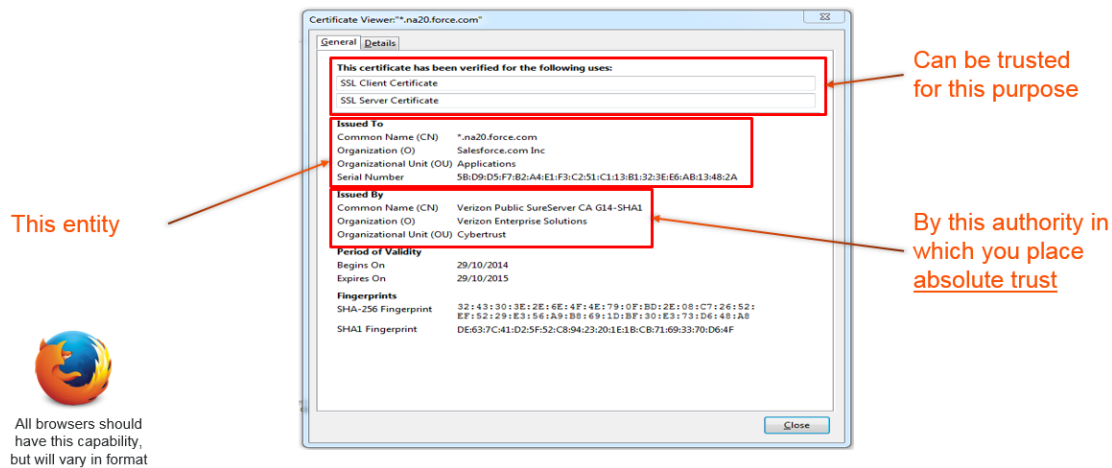


Figure 448: Sample Certificate

Key Store

The key store contains keys and certificate-key pairs. The key store can contain a maximum of 1000 key pairs.

A particular key in the key store can be selected only for decryption (inbound deployment) or for re-signing and decryption (outbound deployment).

Starting in software version 5.2, encrypted or password protected PEM is supported for fetching or downloading a private key.

Starting in software version 5.6.00, ECDSA keys are supported for both inbound and outbound deployments.

Set Up Key Store Certificate Management

A Key Store certificate can be setup to be auto-enabled, auto-deleted and auto-retained to an inline-SSL profile. The configuration can be done as follows:

1. On the top navigation pane, click **Physical**.
2. In the Physical Nodes page, select the node for which you want to configure Key Store settings.
3. Go to **GigaSMART > Inline SSL > Key Store** .
4. Click **Settings**. Configure from the given Key Store settings which are as follows:
 - **Auto Enable New Certificates** – Associates new certificates to an inline-SSL profile, if the new certificate shares a common name with an existing certificate(s) of the inline-SSL profile. The setting will be triggered as and when a new certificate is uploaded or pushed by a third-party tool.
 - **Auto Delete Expired Certificates** – Deletes expired certificates automatically. This setting will be triggered once a day at 12:00:00 UTC. Specify the number of days to retain an expired certificate in the '**Number of days to retain expired certificates**' field. The default value would be 30 days.
 - **Auto Delete Certificates with same entity** – Deletes expired certificates with similar name associated to an inline-SSL profile. Once the setting is updated; the oldest certificate will be deleted as and when the maximum number of allowed certificates are crossed. Specify the maximum number of days to retain an expired certificate with same entity in the '**Max number of Certificates to retain for the same Entity**' field.




Generate and Add a Certificate to Key Store

To generate and add an inline-SSL signing certificate to key store for outbound deployment, perform the following steps:

1. Create an internal root CA (for example, using Microsoft AD, or OpenSSL, or any other CA implementation).
2. Push this CA root certificate to all devices.
3. Issue a sub-CA certificate for Gigamon.
4. Upload the sub-CA certificate to Gigamon with the private key of only the sub-CA.

Display Key Store Certificates

The key store certificates added would be displayed in Key Store page. The following table describes the fields :

Component	Description
Key Alias	The alias name of the Key certificate.
Type	Defines whether the Key Store is a Certificate or a Private Key .
Common name	A common name given to group the key based on domain.
Health Status	<p>The health indicator of a certificate used in traffic flow. The three major indicators with their respective color legend are as follows:</p> <p>Green  - The key certificate is attached to an inline-SSL profile and the profile is part of the inline-SSL GSOP which is used in a traffic map. This will also indicate a certificate which is being used as a signing CA in outbound deployment .</p> <p>Blue  - The key certificate is not actively participating in any traffic flow.</p> <p>Red  - The key certificate has been expired .</p>
Organization	Organization name that provided the key .
.Organization Unit	Organization unit name that provided the key.
Expiry Date	Date on which the key certificate would get expired.
Installed On	Date on which the key certificate was installed.

You can control the key store certificates display by utilizing the filters provided such as ; Key Alias, Common Name, Organization, Organization Unit, Health Status, Expiry Date and Installation Date.

Trust Store

The trust store contains a trusted certificate authority (CA) for server validation. A default trust store from Mozilla is included with this GigaVUE-OS software version. The trust store is updated periodically. You can also fetch a trust store file containing certificates in PEM format if you want to replace the default trust store.

Starting in software version 5.2, CA certificates can be appended to the trust store or specific certificates can be deleted from the trust store. Also, the trust store can be queried for a specific certificate by its fingerprint. The query includes the hex representation of the first four octets of the certificate's SHA1 fingerprint.

Certificate Validation

Gigamon needs to validate the server certificate so that an incoming untrusted certificate is not made legal by Gigamon re-signing the certificate.

The certificate validation process includes several steps as follows:

- **Certificate expiration date and validity period:** The GigaVUE node compares the current date to the validity period listed in the certificate. If the expiration date has not passed and the current date is within the period, the certificate is good.
- **Certificate issued by trusted CA:** The GigaVUE node maintains a list of trusted root CAs. This list determines the certificates that the client will accept. The trust store acts as a trust anchor during certificate validation. The GigaVUE node validates that each incoming certificate chain is trusted by one of the certificates in the trust store.
- **Server name:** The GigaVUE node validates that the server certificate is valid for the hostname mentioned in the SNI. This validation is not performed if the client does not send SNI.
- **Certificate revocation check:** The GigaVUE node validates the server certificate status using OCSP and CRL lists downloaded from the concerned CAs. Internet connectivity is required for this functionality. The certificate revocation check determines the revocation status of the server certificate.

Certificates that pass the validation are accepted. The primary MitM CA signs the forged certificate. Certificates that fail validation can be accepted if security exceptions are configured and the secondary MitM CA signs the corresponding forged certificate. For self-signed certificates, the forged certificate will also be self-signed.

Client applications will typically add the primary MitM CA to their trust store and not to the secondary. This will act as a mechanism to bubble up certificate validation errors on the client applications and provide the end users an opportunity to reject the connection.

If there are certificate validation errors, the SSL connection is dropped unless explicitly permitted by the security exceptions in the policy profile. The certificate validation errors are grouped into the following four categories:

- **Expired:** The validity period of the certificate is in the past.
- **Self-signed:** The certificate is self-signed, meaning that the subject and the issuer are the same. The validity period is current and the certificate signature is valid.
- **Unknown CA:** The CA is not valid. The issuer certificate cannot be obtained from the certificate chain or is not in the trust store.

- **Invalid:** The certificate is not valid for the given SNI (for the Client Hello containing the SNI). There might have been a failure to decrypt or decode the certificate signature or the fields, not and before/not, were not read.

For security exceptions for expired, unknown CA, and invalid certificates, the resulting certificate is signed (re-signed) by the secondary MitM CA, so the user can accept or reject the connection.

Client Authentication

A server can challenge the client by requesting for a client certificate after the server responds with its Server Hello message. The client then respond with its certificate and the server validates the client certificate.

Gigamon does not support client authentication for outbound and inbound connections. If client authentication is detected during server handshake, then the connection is bypassed.

Re-Signed Certificates

As a MitM, Gigamon re-signs certificates. The following fields are copied from the original certificate:

- subject name
- primary signing CA
- certificate validity

The following fields are set in the re-signed certificate:

- certificate type—v3
- serial number—randomly generated
- v3 extensions:
 - basicConstraints CA—True

NOTE: As this is a CA certificate, basicConstraints is set to True. For leaf certificates, basicConstraints is set to False.

- keyUsage—digitalSignature and keyEncipherment
- extendedkeyUsage—serverAuth
- subjectKeyIdentifier—hash
- authorityKeyIdentifier—keyid,issuer:always

Checking Certificate Revocation Status

All server certificates for decrypted outbound connections are issued by the GigaVUE node. The issuing CA is imported into the client's browsers as a trusted CA. Thus, the clients will trust all certificates signed by the GigaVUE node. This interferes with the ability of the clients to check for the revocation status of the certificates. Thus the burden is upon the node to perform the revocation checks on the original server certificates before regenerating the certificates to the clients.

If revocation check is enabled with soft fail, decryption will continue even if the revocation status is not already known, whereas with hard fail, traffic will not be decrypted unless the revocation status is determined for certain.

If revocation check is enabled, once the GigaVUE node determines that the server certificate is revoked, further SSL connections to the server are dropped.

By default, revocation check is disabled.

There are two methods to check the revocation status of the certificates as follows:

- using a Certificate Revocation List (CRL) from the issuing Certificate Authorities (CAs). Refer to [Certificate Revocation List \(CRL\)](#).
- using the Online Certificate Status Protocol (OCSP). Refer to [Online Certificate Status Protocol \(OCSP\)](#).

Certificate Revocation List (CRL)

A Certificate Revocation List (CRL) is an online database of certificates that have been revoked.

Each issuing CA in the PKI infrastructure maintains a list of revoked certificates that they had issued earlier. The list contains the serial number of the revoked certificates and the reasons for the revocation. Any revoked certificate should not be trusted even if the signatures are valid. CAs publish the revocation list periodically.

Each server certificate will contain the CRL location in the "CRL distribution points" X.509 extension.

Online Certificate Status Protocol (OCSP)

The Online Certificate Status Protocol (OCSP) is an Internet protocol used for obtaining the revocation status of an X.509 certificate.

Certificate status can be verified near real-time by querying the OCSP link in the certificate. The link will be present in the "Authority Information Access" X.509 extension.

CRL and OCSP

If both CRL and OCSP are enabled, OCSP is performed first, followed by CRL.

Both CRL and OCSP require Internet connectivity. Refer to [Configure Stack Port Interface](#) for more information.

Supported Ciphers

Inline SSL decryption supports modern cryptographic algorithms. It supports the commonly-supported ciphers.

Combining the following ciphers, MACs, and key exchange algorithms results in many cipher suites:

- Ciphers: RC4_128, DES_CBC, 3DES_EDE_CBC, AES_128_CBC, AES_128_GCM, AES_256_GCM, AES_256_CBC, Camellia, Chacha20
- MAC: MD5, SHA, SHA256, SHA384, Poly1305
- Key exchange algorithms: RSA, DHE_RSA, ECDHE_RSA, ECDHE_ECDSA

Cipher Name	Kx	Au	Enc	Mac
TLS_RSA_EXPORT_WITH_RC4_40_MD5	RSA_EXPORT	RSA_EXPORT	RC4_40	MD5
TLS_RSA_WITH_RC4_128_MD5	RSA	RSA	RC4_128	MD5
TLS_RSA_WITH_RC4_128_SHA	RSA	RSA	RC4_128	SHA
TLS_RSA_EXPORT_WITH_DES40_CBC_SHA	RSA_EXPORT	RSA_EXPORT	DES40_CBC	SHA
TLS_RSA_WITH_DES_CBC_SHA	RSA	RSA	DES_CBC	SHA
TLS_RSA_WITH_3DES_EDE_CBC_SHA	RSA	RSA	3DES_EDE_CBC	SHA
TLS_DHE_RSA_EXPORT_WITH_DES40_CBC_SHA	DHE	RSA_EXPORT	DES40_CBC	SHA
TLS_DHE_RSA_WITH_DES_CBC_SHA	DHE	RSA	DES_CBC	SHA
TLS_DHE_RSA_WITH_3DES_EDE_CBC_SHA	DHE	RSA	3DES_EDE_CBC	SHA
TLS_RSA_WITH_AES_128_CBC_SHA	RSA	RSA	AES_128_CBC	SHA
TLS_DHE_RSA_WITH_AES_128_CBC_SHA	DHE	RSA	AES_128_CBC	SHA
TLS_RSA_WITH_AES_256_CBC_SHA	RSA	RSA	AES_256_CBC	SHA
TLS_DHE_RSA_WITH_AES_256_CBC_SHA	DHE	RSA	AES_256_CBC	SHA

Cipher Name	Kx	Au	Enc	Mac
TLS_RSA_WITH_AES_128_CBC_SHA256	RSA	RSA	AES_128_CBC	SHA256
TLS_RSA_WITH_AES_256_CBC_SHA256	RSA	RSA	AES_256_CBC	SHA256
TLS_RSA_WITH_CAMELLIA_128_CBC_SHA	RSA	RSA	CAMELLIA_128_CBC	SHA
TLS_DHE_RSA_WITH_CAMELLIA_128_CBC_SHA	DHE	RSA	CAMELLIA_128_CBC	SHA
TLS_RSA_EXPORT1024_WITH_RC4_MD5	RSA_EXPORT 1024	RSA_EXPORT 1024	RC4	MD5
TLS_RSA_EXPORT1024_WITH_DES_CBC_SHA	RSA_EXPORT 1024	RSA_EXPORT 1024	DES_CBC	SHA
TLS_RSA_EXPORT1024_WITH_RC4_SHA	RSA_EXPORT 1024	RSA_EXPORT 1024	RC4	SHA
TLS_DHE_RSA_WITH_AES_128_CBC_SHA256	DHE	RSA	AES_128_CBC	SHA256
TLS_DHE_RSA_WITH_AES_256_CBC_SHA256	DHE	RSA	AES_256_CBC	SHA256
TLS_RSA_WITH_CAMELLIA_256_CBC_SHA	RSA	RSA	CAMELLIA_256_CBC	SHA
TLS_DHE_RSA_WITH_CAMELLIA_256_CBC_SHA	DHE	RSA	CAMELLIA_256_CBC	SHA
TLS_RSA_WITH_SEED_CBC_SHA	RSA	RSA	SEED_CBC	SHA
TLS_DHE_RSA_WITH_SEED_CBC_SHA	DHE	RSA	SEED_CBC	SHA
TLS_RSA_WITH_AES_128_GCM_SHA256	RSA	RSA	AES_128_GCM	SHA256
TLS_RSA_WITH_AES_256_GCM_SHA384	RSA	RSA	AES_256_GCM	SHA384
TLS_DHE_RSA_WITH_AES_128_GCM_SHA256	DHE	RSA	AES_128_GCM	SHA256
TLS_DHE_RSA_WITH_AES_256_GCM_SHA384	DHE	RSA	AES_256_GCM	SHA384
TLS_ECDHE_ECDSA_WITH_RC4_SHA	ECDHE	ECDSA	RC4	SHA
TLS_ECDHE_ECDSA_WITH_3DES_EDE_CBC_SHA	ECDHE	ECDSA	3DES_EDE_CBC	SHA
TLS_ECDHE_ECDSA_WITH_AES128_CBC_SHA	ECDHE	ECDSA	AES128_CBC	SHA
TLS_ECDHE_ECDSA_WITH_AES256_CBC_SHA	ECDHE	ECDSA	AES256_CBC	SHA
TLS_ECDHE_RSA_WITH_RC4_SHA	ECDHE	RSA	RC4	SHA

Cipher Name	Kx	Au	Enc	Mac
TLS_ECDHE_RSA_WITH_3DES_EDE_CBC_SHA	ECDHE	RSA	3DES_EDE_CBC	SHA
TLS_ECDHE_RSA_WITH_AES_128_CBC_SHA	ECDHE	RSA	AES_128_CBC	SHA
TLS_ECDHE_RSA_WITH_AES_256_CBC_SHA	ECDHE	RSA	AES_256_CBC	SHA
TLS_ECDHE_ECDSA_WITH_AES_128_CBC_SHA256	ECDHE	ECDSA	AES_128_CBC	SHA256
TLS_ECDHE_ECDSA_WITH_AES_256_CBC_SHA384	ECDHE	ECDSA	AES_256_CBC	SHA384
TLS_ECDHE_RSA_WITH_AES_128_CBC_SHA256	ECDHE	RSA	AES_128_CBC	SHA256
TLS_ECDHE_RSA_WITH_AES_256_CBC_SHA384	ECDHE	RSA	AES_256_CBC	SHA384
TLS_ECDHE_ECDSA_WITH_AES_128_GCM_SHA256	ECDHE	ECDSA	AES_128_GCM	SHA256
TLS_ECDHE_ECDSA_WITH_AES_256_GCM_SHA384	ECDHE	ECDSA	AES_256_GCM	SHA384
TLS_ECDHE_RSA_WITH_AES_128_GCM_SHA256	ECDHE	RSA	AES_128_GCM	SHA256
TLS_ECDHE_RSA_WITH_AES_256_GCM_SHA384	ECDHE	RSA	AES_256_GCM	SHA384
TLS_ECDHE_RSA_WITH_CHACHA20_POLY1305	ECDHE	RSA	CHACHA20	POLY1305
TLS_ECDHE_ECDSA_WITH_CHACHA20_POLY1305	ECDHE	ECDSA	CHACHA20	POLY1305
TLS_DHE_RSA_WITH_CHACHA20_POLY1305	DHE	RSA	CHACHA20	POLY1305

Diffie Hellman Ephemeral (DHE) is a key exchange protocol.

Inline SSL decryption supports key cipher suites and exchanges without downgrading cryptography levels of the organization.

Ciphersuites are a standard combination of the following:

- bulk encryption algorithm—Specifies how to encrypt communications, including the algorithm, key size, and the cryptographic mode used. For example, AES_128_CBC is AES with 128-bit keys in Cipher Block Chaining mode.
- key exchange algorithm—Specifies how both sides authenticate each other during the SSL handshake. For example, RSA.
- message authentication code (MAC)—Specifies the hash algorithm used to verify that communications have not been tampered with. For example, SHA.
- pseudorandom function—Specifies how a 384 bit master secret, which is used as a source of randomness for session keys, is generated.

NOTE: SSL transactions with unsupported ciphers will be bypassed/TCP proxied.

The following key sizes are supported:

- RSA—512, 1024, 2048, 3072, 4096, 8192
- DH—1024, 2048, 4096
- ECC—prime256v1, ecsecp256r1, ecsecp384r1, ecsecp521r1

The following TLS extension is supported:

- RFC7301—Application-Layer Protocol Negotiation (ALPN)

Policy Profile

The policy profile consists of multiple rules, with each rule having a decrypt or no-decrypt action for the match condition. For example, there might be a policy to decrypt all but financial-related traffic.

In addition to the rules, the profile also consists of various configuration options that affect the decryption decision as follows:

- The default action to take if none of the rules match.
- The URL cache miss action to take if the URL category-based rules are configured, but GigaSMART does not have the category information.
- For decrypted traffic, options to override expired, invalid, self-signed, and unknown CA certificates and to enable or disable the certificate revocation check.
- Whether or not to send decrypted/non-decrypted traffic through the tools.

Each policy rule consists of a match condition and the decrypt or no-decrypt action for the match. The following rule types are available:

- URL category
- hostname/domain name
- server certificate issuer
- source and destination IP address
- source and destination port numbers
- VLAN identifier

NOTE: You can configure up to 1024 policy rules under a policy profile.

Policy Evaluation

Policies are evaluated by GigaSMART at various phases as shown in [Figure 449: Policy Validation Flow](#).

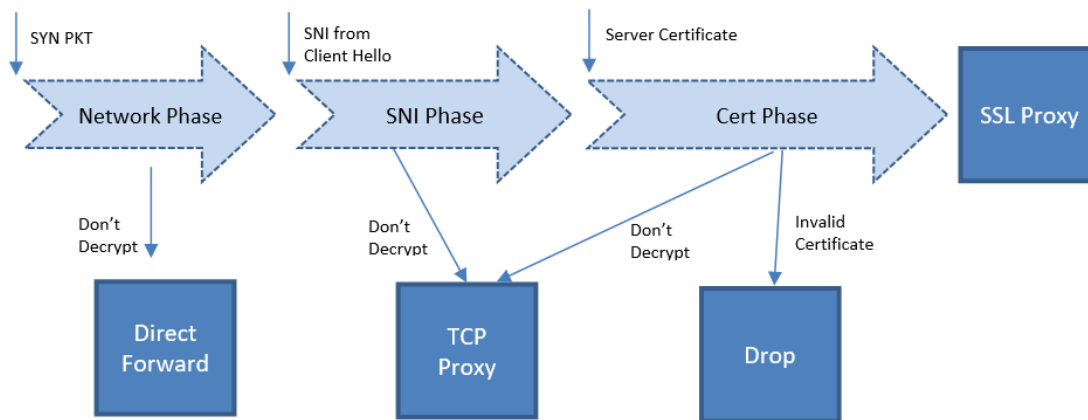


Figure 449: Policy Validation Flow

Network Phase

The Network Phase of the policy is done on the SYN packet. In this phase:

- The policy engine inputs are source and destination IP addresses, source and destination ports, and VLAN identifiers.
- The no-decrypt rules are evaluated before the decrypt rules, which are ordered by the following match conditions: source IP, destination IP, source port, destination port and VLAN.
- If traffic is not to be decrypted, packets are processed as non-proxy traffic. The bypass VLAN is used. Refer to Direct Forward in [Figure 449: Policy Validation Flow](#).

NOTE: The no-decrypt verdict is always final for the lifetime of the given TCP connection.

- Traffic that is to be decrypted continues to the next phase. The decrypt verdict from the Network Phase can be overridden by more specific rules in the next phase.

Following conditions are considered for traffic that is to be decrypted:

- If the Client Hello packet contains SNI, policy is evaluated in the SNI phase and then in the Certificate phase.
- If the Client Hello packet does not contain SNI, policy is evaluated only in the Certificate phase.
- For HTTPS proxy connections, policy rules are evaluated based on the hostname from the HTTPS proxy CONNECT request in addition to the SNI.

SNI Phase

The SNI Phase of the policy is done on the Server Network Indication (SNI) from the Client Hello. In this phase:

- The policy engine input is the hostname from SNI.
- Rules are evaluated in the following order:
 - whitelist/no-decrypt domain
 - blacklist/decrypt domain
 - no-decrypt category
 - decrypt category

NOTE: Domain/whitelist rules apply for all subdomains as well. For example the following are recognized as being part of gigamon.com: ftp.gigamon.com, www.gigamon.com, www.gigamon.com/default.htm.

- If traffic is not to be decrypted, packets are processed as TCP proxy. Refer to TCP Proxy in [Figure 449: Policy Validation Flow](#).
- For traffic that is to be decrypted, the plaintext version is sent through the tools based on the decrypt tool-bypass configuration.

If URL category-based rules are configured and a URL cache miss occurs, the policy verdict is based on the settings of the URL cache miss action. A cache miss action of decrypt or no-decrypt will cause the traffic to be decrypted or not decrypted immediately. The defer action will cause delays.

For compliance reasons, the cache miss action of no-decrypt is recommended.

Certificate Validation

In the case of a decrypt decision from the SNI phase or if the Client Hello does not contain SNI, GigaSMART will verify the server certificate using the configured trust store. Additional checks will be performed for certificate expiry, hostname mismatch, and self-signed certificate. If configured, revocation check will also be done on otherwise valid server certificates.

For valid server certificates, GigaSMART will issue the corresponding server certificate using the primary MitM CA. If the validation fails, the connection will be dropped unless a security exception is configured. The secondary MitM CA, if configured, will be used to issue server certificates in that case.

Starting in software version 5.2, the primary MitM CA is not mandatory for an inbound deployment.

Cert Phase

The certificate phase of policy evaluation is done for all connections after the certificate validation is completed. In this phase:

- The policy engine inputs are the certificate issuer and the certificate subject name.
- The Common Name (CN) attribute is extracted from the server certificate subject name. Policy evaluation in this phase is performed on the value of the CN attribute. This is similar to the SNI phase. If no matching rules are found, the certificate issuer-based rules are evaluated. For issuer-based rules, the CN attribute and the Domain Name (DN) attribute of the issuer are considered.
- If traffic is not to be decrypted, packets are processed as TCP proxy. Refer to TCP Proxy in [Figure 449: Policy Validation Flow](#). The server SSL session is reset and the Client Hello is resent to the server.
- GigaSMART supports certificate based policy evaluation for HTTPS proxied connections. It applies policy rules based on the hostname from HTTPS proxy CONNECT request for HTTPS proxy connections. Also, if required it applies no-decrypt in the certificate phase for HTTPS proxy connections.
- Certificate phase policies are also evaluated for HTTPS proxy connections.

Policy Profile Options

This section describes a few of the options for the policy profile. Refer to the following:

- [Inline SSL Decryption Port Map](#)
- [Enable or Disable Tool Bypass](#)
- [High Availability Active Standby](#)
- [Inline Network Group Multiple Entry](#)

Inline SSL Decryption Port Map

The TCP destination port for decrypted traffic sent to inline tools can be configured as part of the profile.

Following are the two priorities that GigaSMART uses to decide on the TCP port number used for decrypted traffic:

- Priority 1—This is a port map, which is user configurable. You can specify both the In Port and the Out Port. The In Port is the TCP destination port from a client. The Out Port is the TCP port used to send traffic to inline tools.

- Priority 2—This is a default Out Port. This TCP port will be used if the incoming port does not match those specified in Priority 1.

Enable or Disable Tool Bypass

Tool bypass can be enabled or disabled for the following types of traffic:

- SSL decrypted traffic
- non-decrypted SSL traffic (non-SSL TCP)
- non-SSL traffic (non-TCP)

By default, tool bypass is disabled on these traffic types, meaning that all decrypted SSL, non-decrypted SSL, and non-SSL traffic is sent to the tools. When tool bypass is enabled on a specified traffic type, that traffic is not sent to the tools.

High Availability Active Standby

Starting in software version 5.2, inline network high availability active standby is supported. When enabled, link switchover by an upstream device in active/standby scenario is detected.

For example, when there is an inline SSL network group topology with two network port pairs (Na1, Nb1 and Na2, Nb2), the incoming traffic from one network (for example, Na1) may change to another network (for example, Na2) due to upstream devices, such as firewalls performing high availability active standby failover. If an upstream device fails over, GigaSMART will forward traffic to the correct inline network.

The default is disabled.

NOTE: Do not enable this option if the inline SSL network group links are in an active/active scenario.

Inline Network Group Multiple Entry

An inline network group topology can have multiple network port pairs (for example, Na1, Nb1 and Na2, Nb2). With multiple network port pairs, traffic from a network interface might traverse GigaSMART multiple times. Intercepted traffic from GigaSMART might reenter GigaSMART through a different network interface within the same network group as shown in [Figure 450: Inline SSL Inline Network Group Configuration](#).

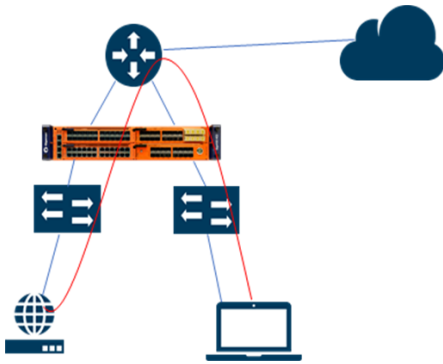


Figure 450: Inline SSL Inline Network Group Configuration

When the inline SSL GigaSMART sits between internal devices and the upstream router, traffic from the devices to the Internet will be intercepted by GigaSMART. When internal devices belonging to different network port pairs within the same inline network group communicate with each other, traffic initiated from a device will be intercepted by GigaSMART and sent to the upstream router. This traffic will be routed back to GigaSMART from a different network port pair to reach the destination device.

Starting in software version 5.3, the same traffic sent from GigaSMART can reenter GigaSMART.

GigaSMART remembers the inline incoming inline network interface (for example, Na1) for each connection. When traffic from the same connection reaches GigaSMART with a different inline network interface within the same network group (for example, Na2), GigaSMART will forward the traffic to the corresponding opposite network interface (for example, Nb2), without further processing. This allows traffic from the same connection to reenter GigaSMART. GigaSMART will detect it and start forwarding traffic to the new network port pair.

However, the same traffic sent by GigaSMART reentering through the same network port pair (for example, Nb2, Na2) is not supported.

Other than the use case described above, any connection with traffic passing through GigaSMART involving more than the original network pair is not supported. If the first packet of a connection comes in through Na1, all traffic has to enter GigaSMART through the network port pair, Na1, Nb1.

You can enable or disable the inline network group multiple entry for the profile. The default is disabled.

Caches

There are four in-memory caches as follows. They are not configurable.

- re-signed certificate cache
- URL category cache

- revocation certificate cache
- session resumption cache

Cache Persistence

Caches are maintained for Internet lookups such as URL categorization and certificate revocation checks using OCSP or CRL for faster subsequent lookups. The cache persistence feature allows the information to be saved on the GigaVUE node in the control card's persistent storage so that it can be retrieved in case of reboots. This allows the GigaSMART card to start with the information learned earlier. This feature is enabled by default and can be disabled if needed.

You can search for specific entries in the caches, clear them, and display a summary of the records.

GigaSMART Overload Bypass

Packet buffers, CPU, and concurrent connections are monitored for overloaded conditions. GigaSMART goes to bypass when resource usage exceeds thresholds. Existing connections will continue to be processed by GigaSMART, but any new connections will be bypassed. Refer to [Overload Bypass Connections and Thresholds](#) for information on connections and thresholds.

Table 69: Overload Bypass Connections and Thresholds

Criteria	GigaVUE-HC1	GigaVUE-HC2 (per module)	GigaVUE-HC3 (per GigaSMART Engine)
Maximum connections per second	1500	<ul style="list-style-type: none"> • 2000 (SMT-HC0-X16 and SMT-HC0-R) • 5000 (SMT-HC0-Q02X08) 	5000
Maximum connections	100000	<ul style="list-style-type: none"> • 100000 (SMT-HC0-X16 and SMT-HC0-R) • 200000 (SMT-HC0-Q02X08) 	200000
FPA overload	Default 80% (configurable)		
Heap exhaust	Default 80% (configurable)		
CPU	Default 90% (configurable)		

CPU Overload Threshold

Due to sudden bursts of traffic, the GigaSMART CPU can become too busy and drop packets. However, when a system or application reaches a threshold, SSL sessions can be bypassed. When a maximum CPU is reached, incoming connections will be bypassed.

When the CPU overload threshold is set to a configured value, (for example, 90%), the lower threshold is set to two-third of the CPU overload threshold configured (in this example 60%). A mean threshold is calculated, which will be the average of the CPU overload threshold and the lower threshold (in this example 75%).

The following actions will be taken:

- If the CPU hits the overload threshold, all new SSL connections will be bypassed.
- If the CPU reduces to the mean threshold, half of the new SSL connections will be bypassed.
- If the CPU reduces further to the lower threshold, all new SSL connections will be decrypted.

If you choose connectivity-over-security, the CPU overload threshold must be set to the lower threshold value.

Inline SSL Monitor Mode

Use the inline SSL monitor mode to assist in understanding your network topology. Monitor mode provides information about the traffic going to the GigaSMART card, which can help to learn about your deployment. When monitor mode is enabled, the monitor application collects information such as TCP ports used and VLAN information about the incoming traffic.

After inline SSL decryption is configured and monitor mode is enabled, the inline SSL application does not terminate the session. Instead, the monitor application collects information and forwards packets to the tool port or network port based on the configuration of the non-SSL TCP bypass action. For any Monitor mode, you can enable or disable seamlessly without any other configuration changes.

Monitor mode is disabled by default. To enable the monitor mode, refer to [Configure the Inline SSL Monitor Mode](#).

For packets coming from the network port, the monitor application collects packet flow information.

From the information collected from monitor mode, you can analyze the following cases:

- duplicate TCP SYN—For a given session, the SYN messages with a different packet signature than 5tuple, for example, a different VLAN ID, indicates the packet is coming from multiple paths.

- asymmetric routing—For a given session, packets arriving from multiple network interfaces indicates a packet is coming from multiple paths.

Inline SSL Monitor mode only captures TCP information, not SSL information. However Inline SSL Persistent Monitor mode captures both TCP and SSL information.

NOTE: Monitor mode is supported for standalone nodes only, not for nodes in a cluster.

Configure the Inline SSL Monitor Mode

You can enable or disable the inline SSL monitor mode, or enable persistent inline SSL monitor mode using either CLI command or GigaVUE-FM.

To enable or disable the monitor mode using CLI, run the following CLI command:

```
(config) # apps inline-ssl profile alias sslprofile monitor enable
(config) # apps inline-ssl profile alias sslprofile monitor disable
```

To enable the persistent monitor mode using CLI, run the following CLI command:

```
(config) # apps inline-ssl profile alias sslprofile monitor inline
```

To enable the monitor mode using GigaVUE-FM:

1. From the device view, go to **GigaSMART > Inline SSL > SSL Profiles**.
2. Click **Edit**.
3. From the **SSL Monitor Mode** drop-down list, select
 - **Disable** to disable SSL monitor mode, and enable SSL decryption/encryption.
 - **Enable** to enable SSL monitor mode, and disable SSL decryption/encryption.
 - **Inline** to enable persistent monitor mode (both SSL monitor mode, and SSL decryption/encryption).
4. Click **OK**.

Inline Tool Configurations

Inline tools connect to the GigaVUE node through inline bypass (BPS) modules, available on the GigaVUE-HC1, GigaVUE-HC2, and GigaVUE-HC3.

The inline bypass arrangements supported by inline SSL decryption are as follows:

- single inline network. The inline network ports can be protected, unprotected, or a mix of protected and unprotected.
- inline network group, consisting of multiple inline networks
- single inline tool

- inline tool group, consisting of multiple inline tools over which traffic is distributed
- inline tool group with a spare inline tool, in which the failure of one tool in the inline tool group will trigger a failover to the spare
- inline series, in which traffic is guided through inline tools in a particular order

In summary, inline SSL decryption can be deployed in any combination of inline network and inline network group with any inline tool, inline tool group, or inline series.

Inline tool ports can be configured in shared mode. When an inline tool is shared (true), the decrypted traffic will be VLAN tagged. The connected inline device is expected to receive VLAN tagged packets instead of untagged packets. There is an extra outer VLAN tag added to the packet, which the connected inline device needs to see. When an inline tool is not shared (false), the extra VLAN tag is not added. This allows untagged traffic to be sent to the tool ports. Use false for inline tools that are not able to handle more than one VLAN tag, such as Q-in-Q tagged packets. For tagless mode, if an inline tool is involved in an inline SSL map, the inline tool cannot be used in any other classic inline map.

Refer to [Figure 451: Simple Inline Tool Arrangement](#) to [Figure 453: Serial Inline Tool Arrangement](#) for inline tool arrangements. Encrypted traffic is shown in solid lines, decrypted traffic is shown in dotted lines.

[Figure 451: Simple Inline Tool Arrangement](#) shows a simple inline tool arrangement with one inline tool connected to the GigaVUE node. Traffic is decrypted and sent to the inline tool.

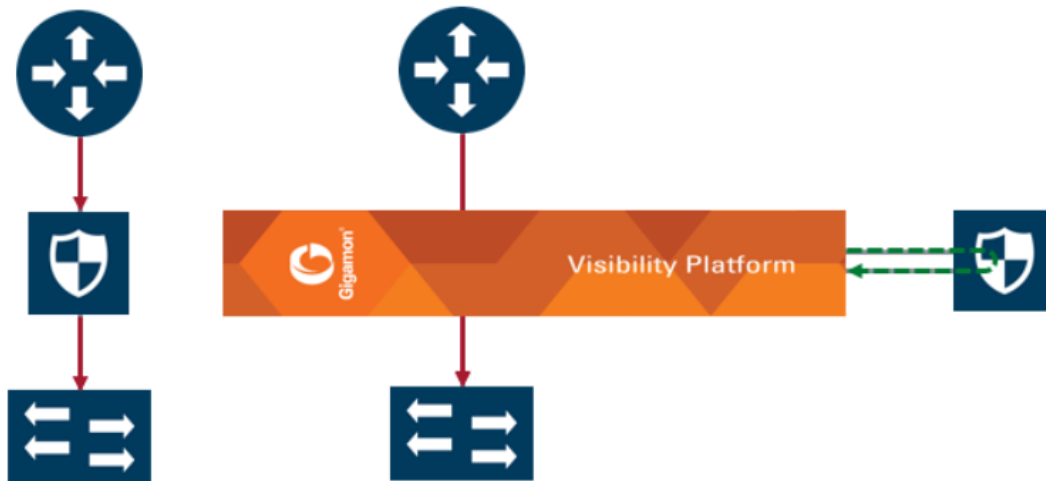


Figure 451: Simple Inline Tool Arrangement

[Figure 452: Multiple Inline Tool Arrangement](#) shows a multiple inline tool arrangement with three inline tools connected to the GigaVUE node. Decrypted traffic is distributed across the tools.

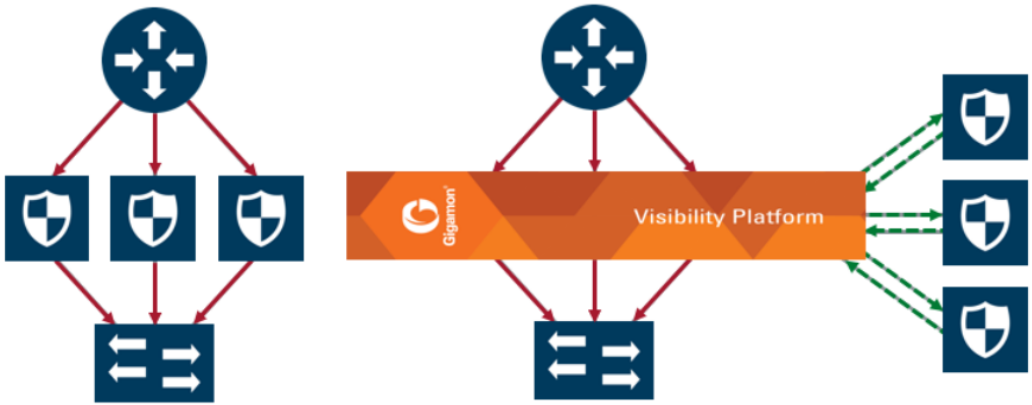


Figure 452: Multiple Inline Tool Arrangement

Figure 453: Serial Inline Tool Arrangement shows a serial inline tool arrangement in which traffic is decrypted on the GigaVUE node, sent serially through the inline tool, and then re-encrypted on the GigaVUE node.

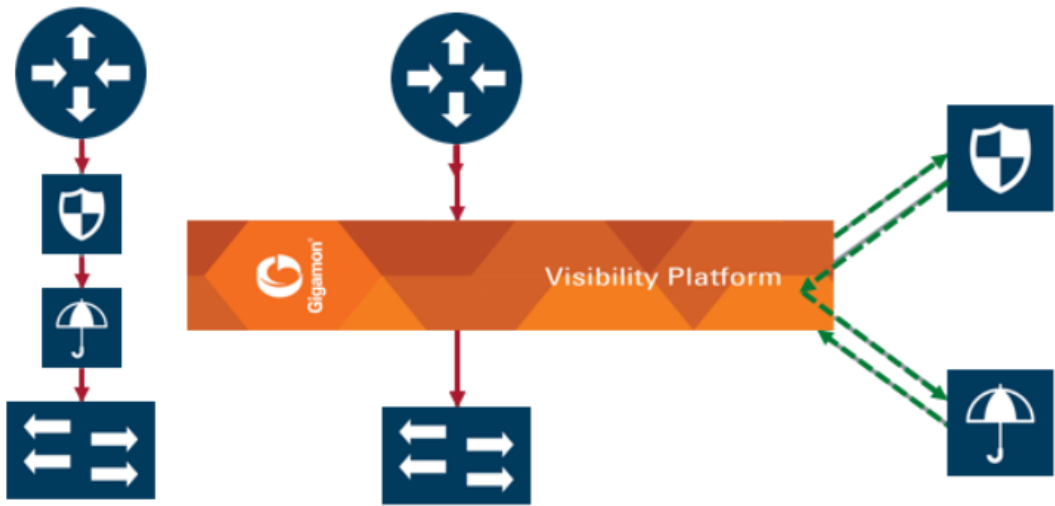


Figure 453: Serial Inline Tool Arrangement

Inline Bypass Restriction

The inline bypass arrangements supported by inline SSL decryption have the following restriction:

- inline network group does not support ingress VLAN tagging on the member links

Forwarding

Inline SSL decryption supports the following kinds of forwarding:

- inline forwarding—Packets can be forwarded from the inline network or inline network group to the inline tool, inline tool group, or inline series.
- inline out-of-band forwarding—Packets from inline ports can be sent to regular tool ports.
- inline bypassing—Packets can be put in loopback between two ports of an inline network.
- SSL forwarding—Packets from an inline network or inline network group can be sent to GigaSMART, then from GigaSMART to an inline tool, inline tool group, or inline series.
- GigaSMART out-of-band forwarding—Packets from GigaSMART can be copied to tool ports.

Failover

The inline bypass module detects failure either through link loss or tool heartbeat failure.

The inline bypass module supports the following failover actions:

- inline tool failover action—Specifies the failover action taken in response to a failure of an inline tool.
- inline tool group failover actions—Specifies the failover action taken in response to a failure of an inline tool group, when the number of healthy inline tools in the inline tool group (including the spare inline tool, if configured) falls below the configured minimum.
- inline tool series failover actions—Specifies the failover action taken in response to a failure of an inline tool series as a whole. An inline tool series is declared to be in a failure condition as soon as any of its member inline tools goes into a failure condition. An inline tool series recovers from a failure condition after all the member inline tools recover from their failure conditions. The failover-action attributes of the individual inline tools participating in an inline tool series are ignored. Instead, the failover-action configured for the inline tool series is respected.

The inline bypass failover actions are configurable. Refer to the *GigaVUE-OS-CLI Reference Guide* for the actions and default values of the `inline-tool`, `inline-tool-group`, and `inline-serial` commands.

The virtual port also has configurable failover actions. Refer to the *GigaVUE-OS-CLI Reference Guide* for the actions and default value of the `vport` command.

The GigaSMART module might also have events such as port down or card down. These failover actions are not configurable but are triggered by events. These events should not impact traffic.

Out-of-Band and Inline Tools

After decryption, traffic can be sent to multiple tools. The tools can be either inline or out-of-band.

Out-of-band tools process the decrypted packets offline. The tools are connected to the GigaVUE node through tool or hybrid ports, GigaStream, or port groups with tool or hybrid ports. The out-of-band tools receive a copy of the decrypted packets from the GigaSMART module. This is referred to as GigaSMART out-of-band forwarding.

Inline tools process the decrypted packets inline. Inline tools are connected to the GigaVUE node through inline bypass (BPS) modules.

An out-of-band tool might be an Intrusion Detection System (IDS) examining decrypted packets:

- If it detects a threat, the IDS will send a notification back, but does not have the ability to act.

An inline tool might be an Intrusion Prevention System (IPS) examining decrypted packets:

- If it does not detect a threat in the decrypted packets, the traffic comes out of the inline tool and goes back to the GigaSMART module to be re-encrypted and sent to the server.
- If it detects a threat, the IPS can act. The action depends on the tools' behavior. It can either terminate the connection or modify packets
- If the IPS terminates the connection, then GigaVUE node will terminate the connection between the client and the server.
- If the IPS modifies packets, then the modified packets will come out of the inline tool, go to the GigaSMART module to be re-encrypted, and sent to the server.

When an inline tool is shared, you must:

- configure the inline second level out-of-band map to forward proxy traffic from GigaSMART to the out-of-band tool port.

When an inline tool is not shared, you must configure only the inline second level out-of-band map to forward proxy and non-proxy traffic from GigaSMART to the out-of-band tool port.

Service Chaining of Decrypted Traffic

Service chaining of decrypted traffic may be required for compliance purposes.

This is done by directing the decrypted traffic to a hybrid port and applying the required GigaSMART operations on the traffic that is looped back from the hybrid port, before forwarding the traffic to the out-of-band tool.

The GigaSMART operations must be configured on a different GigaSMART engine than the one used for inline SSL decryption.

Get Started with Inline SSL Decryption

This section describes the pre-requisites needed before you begin configuring inline SSL decryption. Refer to the following sections for details:

- [Supported Platforms](#)
- [GigaSMART Licensing](#)
- [GigaSMART Compatibility](#)
- [Install GigaVUE Modules](#)
- [Install Software Version](#)
- [Install U-Boot Version on GigaVUE-HC2](#)
- [Install MitM Certificates in Client Trust Store](#)
- [Configure Stack Port Interface](#)
- [Set up GigaSMART for Inline SSL decryption on GigaVUE-HC1](#)
- [SSL Decryption for Inline Tools](#)
- [Configure Primary Certificate and Key](#)

Supported Platforms

Inline SSL decryption is supported on GigaVUE-HC1, GigaVUE-HC2, and GigaVUE-HC3 nodes.

GigaSMART Licensing

The required GigaSMART license is SSL Decryption for Inline and Out-of-Band Tools.

NOTE: A GigaSMART license for Inline SSL is required to upgrade a passive SSL to inline SSL.

GigaSMART Compatibility

Inline SSL decryption is not compatible with any other GigaSMART operations, including out-of-band SSL decryption. Configure inline SSL decryption on a GigaSMART engine that is not shared with any other GigaSMART operation. Inbound and Outbound Inline-SSL decryption can be deployed on a single GigaSMART engine. Moreover, for GigaVUE-HC2 nodes, it is recommended that you create separate GigaSMART operations for front and rear GigaSMART engines.

However, in GigaVUE-HC1 nodes, you can configure inline SSL along with other GigaSMART applications. Refer to [Set up GigaSMART for Inline SSL decryption on GigaVUE-HC1](#) for more information.

Install GigaVUE Modules

Install the GigaSMART and inline bypass module or copper TAP on the same GigaVUE-HC1 or GigaVUE-HC2 node or install the GigaSMART and inline bypass module on the same GigaVUE-HC3 node.

Install Software Version

Install software version 5.2.xx or higher for the GigaVUE-OS CLI, GigaVUE-OS H-VUE, and GigaVUE-FM.

Install U-Boot Version on GigaVUE-HC2

The U-Boot version on GigaVUE-HC2 nodes must be upgraded to version 2011.06.9 or higher. The upgrade can only be done from the CLI.

To check the U-Boot version, use the following command:

```
(config) # show version
```

For example on a GigaVUE-HC2 node, the following output is displayed:

```
U-Boot version: 2011.06.8
```

If you do not have version 2011.06.9 or higher, you will have to do a U-Boot upgrade, after the image installation. Refer to the *GigaVUE-OS Upgrade Guide* for details on installing an image.

After the image installation of the software, use the following command to upgrade the U-Boot version:

```
(config) # uboot install
```

The binary bootloader code included with the installed image is installed.

NOTE: The newer U-Boot version only goes into effect after a reload.

Install MitM Certificates in Client Trust Store

For an outbound deployment, the Man-in-the-Middle (MitM) certificates must be installed in the client trust store. Install the certificates as a Trusted Root Authority in web browsers on the client PC.

Refer to your browser's documentation for installing CA certificates to the trust store.

Configure Stack Port Interface

Internet connectivity is required for CRL, OCSP, and URL categorization. The stack port interface must be configured on the GigaSMART engine. You can configure one stack port for all the GigaSMART engines in a GigaVUE node. However, you must configure all the engines with unique DHCP or static

IP address.

Refer to [Figure 454: Stack Port Location on GigaVUE-HC2 Front](#) for the location of the stack port on the front of the GigaVUE-HC2. It is the second port from the top on the left side of the chassis.

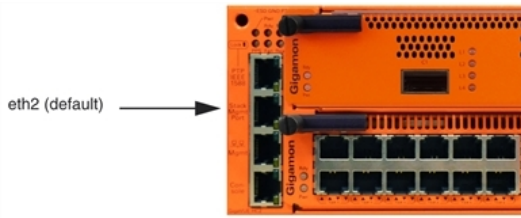


Figure 454: Stack Port Location on GigaVUE-HC2 Front

Refer to [Figure 455: Stack Port Location on GigaVUE-HC3 Front](#) for the location of the two stack ports, eth2 (default) and eth3 on the control card in the front of GigaVUE-HC3. You can use either one or both the stack ports for GigaSMART connectivity.

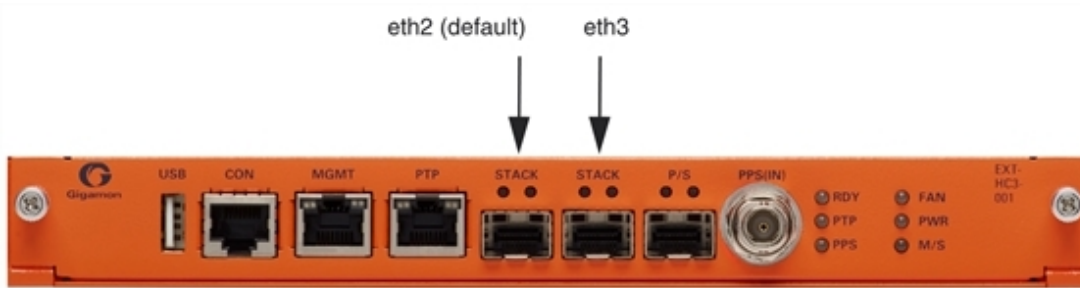


Figure 455: Stack Port Location on GigaVUE-HC3 Front

Refer to [Figure 456: Stack Port Location on GigaVUE-HC1 Front](#) for the location of the stack port on the front of the GigaVUE-HC1. It is the top port on the right.

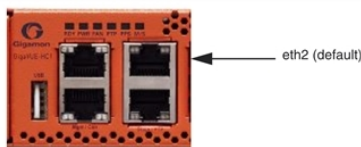


Figure 456: Stack Port Location on GigaVUE-HC1 Front

Configure Stack Port Interface

To configure the stack port interface:

1. Go to **Ports > All Ports**. Select a GigaSMART engine port and click **Edit**.
2. Specify either an IP Address, Netmask, Gateway, DNS IP, and optional MTU or select DHCP. Specify a VLAN ID in the range from 20 to 4094. Select the stack port interface, Eth2 or Eth3. The default is Eth2.
3. Click **OK**. The stack port interface is added.

Set up GigaSMART for Inline SSL decryption on GigaVUE-HC1

You can configure GigaSMART engine resources on GigaVUE-HC1 to reduce the Inline SSL resource utilization by 50% and use the rest of the resource to configure the other GigaSMART applications. The Inline SSL application runs in the following two modes:

- **Standalone mode Enabled**—The Inline SSL feature takes the entire GigaSMART engine resource. By default standalone mode is enabled for Inline SSL.
- **Standalone mode Disabled**—The GigaSMART engine resource allocated for Inline SSL feature is reduced to 50% and the residual GigaSMART engine resource can be configured for other GigaSMART applications.

On GigaVUE-HC1, you can configure the following GigaSMART applications along with the Inline SSL feature:

- De-duplication (SMT-HC1-DD1)
- NetFlow Generation (SMT-HC1-NF1)
- BSE Combo (SMT-HC1-BSE) - Masking, Slicing, and Trailer
- Header-stripping (SMT-HC1-HS1)
- Flow Sampling (SMT-HC1-FVU)
- Tunneling, ERSPAN (SMT-HC1-TUN)

Limitations

- It is not recommended to configure Inline SSL feature with other GigaSMART applications, except the applications listed above.
- The OoB SSL decryption is not recommended to be configured with Inline SSL feature and combination of Netflow and SSL decryption do not work with the Inline SSL.
- For inline SSL decryption, Internet connectivity to GigaSMART and clustering is not supported on the same interface, for example, eth2.

Enable Standalone mode for Inline SSL decryption

To enable Standalone mode for Inline SSL decryption on GigaVUE-HC1:

1. From the GigaVUE-HC1 device view, select **GigaSMART > GigaSMART Groups > GigaSMART Groups**.
2. Click **New** to create a new GigaSMART group or click **Edit** to modify an existing GigaSMART group.
3. Go to **Inline SSL** under **GigaSMART Parameters**, and select **Standalone**.
4. Click **OK**.

Configure Keychain Password

For Inbound and Outbound Inline-SSL deployments, the keychain password must be configured before installing the certificates and private keys into the keystore.

Refer to [Configure Inline SSL Decryption Using GigaVUE-FM](#) for the configuration steps.

Configure Primary Certificate and Key

For an outbound deployment, at least one of the CAs must be configured (primary or secondary). For an inbound deployment, a CA is not necessary.

The primary CA re-signs certificates for servers that present a valid certificate. The secondary CA re-signs certificates for servers that are invalid or that fail validation. If the secondary CA is not configured, the primary CA will be used for all certificates.

Refer to [Configure Inline SSL Decryption Using GigaVUE-FM](#) for the configuration steps.

Configure an Inline SSL Session Logging Server Using CLI

You can configure an inline SSL session logging server to store the logged events that are generated when there are any changes made to the devices. You can specify the type of events that must be logged in to the server.

The following table provides a mapping of the severity, log level and its description:

Severity	Log Level	Description
0	Emergency	System is unusable
1	Alert	Action must be taken immediately
2	Critical	Critical condition
3	Error	Error condition
4	Warning	Warning condition
5	Notice	Normal but significant condition
6	Informational	Informational message
7	Debug	Debug message

The logged events are stored in the Common Event Format (CEF) as follows:

```
<SYSLOG_HEADER> <Timestamp> <hostname:engine> CEF:0[Gigamon]<Device Model>|<GigaVUE OS Version>|<Event ID>|<Event name>|<Severity>|[Extension]
```

Here is an example of a logged event:

```
Thu Jun 14 15:50:16 2018 hostname:hc2_test:1/1/e1
CEF:0|Gigamon|HC2|5.5.0|102|SESSION_DECRYPT|6|src=126.1.0.20
dst=126.1.0.10 spt=34267 dpt=443 dhost=example.com
cs1Label=Certificate Subject cs1=C\=US, ST\=CA, L\=Santa Clara,
CN=*.example.com cs2Label=Cipher Suite cs2=DHE-RSA-AES128-GCM-SHA256
```

You can view and track these logs to troubleshoot system issues, maintain audit trails, and for compliance purpose.

To configure an inline SSL session logging server using GigaVUE-FM:

Task	Description	UI Steps
1.	Configure a tool port.	<ol style="list-style-type: none"> From the device view, go to Ports > All Ports. Click Quick Port Editor. Use Quick search to find the port to configure. Set the type as Tool for the required port, and then select Enable. Click OK.
2.	Configure an IP interface with an IP address, subnet mask, default gateway, and MTU setting. Assign it to the GigaSMART group.	<ol style="list-style-type: none"> From the device view, go to Ports > Ports > IP Interfaces. Click New. The IP Interface page opens. In the Alias and Comment fields, enter the name and description of the IP interface. From the Ports drop-down list, select the tool port that you configured in step 1. Select the Type of the IP interface as IPv4 or IPv6. Enter the IP address, subnet mask, gateway, and MTU settings in the respective fields. From the GS Groups drop-down list, select a GigaSMART group under which you want to configure the inline SSL session logging server. Click OK.
3.	Configure the inline SSL session logging server under the GigaSMART group to which you assigned the IP interface in the task 2.	<ol style="list-style-type: none"> From the device view, go to GigaSMART > GigaSMART Groups.

Task	Description	UI Steps
		<ol style="list-style-type: none"> b. Choose the GigaSMART group to which you assigned the IP interface that you configured in task 2. c. Click Edit. d. Under GigaSMART Parameters > Inline SSL Session Logging, click Add Remote Syslog Server. e. In the Remote Syslog IP and Remote Syslog Port Number fields, enter the IP address and port number of the remote syslog server. f. From the Associated IP Interface drop-down list, select the IP interface that you assigned to the GigaSMART group in task 2. g. From the Log Level drop-down list, select the severity log level of the events that you want to send to the inline SSL session logging server. h. Click OK.

Configure Inline SSL Decryption

This section describes the workflows for configuration inline SSL decryption using GigaVUE-FM. It also provides the details of the workflows for inline SSL map. Refer to the following sections for details:

- [Introduction to Inline SSL Map Workflows](#)
- [Configure Inline SSL Decryption Using GigaVUE-FM](#)
- [View Statistics](#)

Introduction to Inline SSL Map Workflows

In GigaVUE-FM, workflows guide you through configuration steps. For the Inline SSL Map configuration, there are seven flows, Flow A to Flow G based on which you can perform different configurations.

Go to **Workflows** and select **Inline SSL Map** from the Inline GigaSMART Operations section as shown in [Figure 457: Select Inline SSL Map Configuration](#).

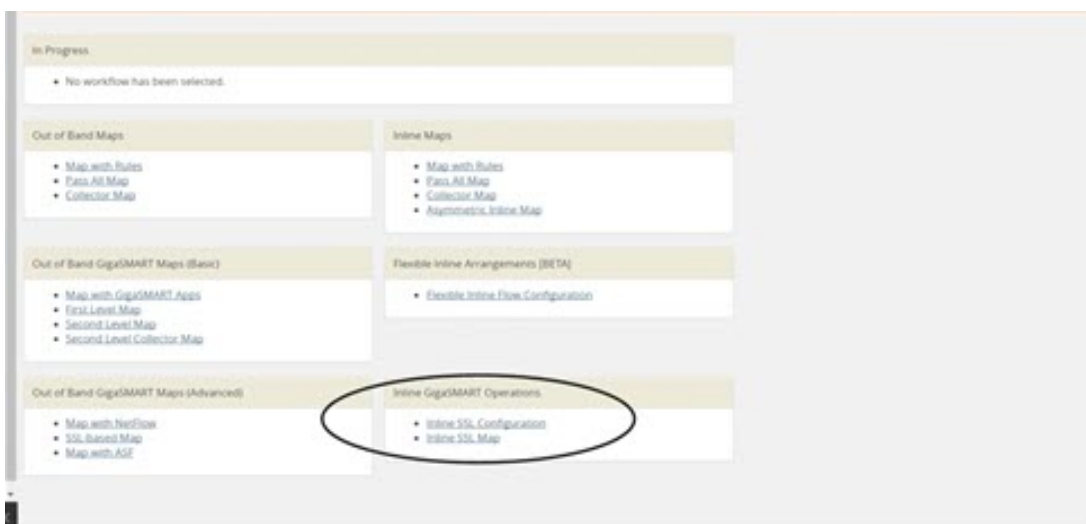


Figure 457: Select Inline SSL Map Configuration

Flow A to Flow G are displayed as shown in Figure 458: Flow A to Flow G.



Figure 458: Flow A to Flow G

The following sections describe each flow:

- Install GigaVUE Modules
- Install Software Version
- Install U-Boot Version on GigaVUE-HC2
- Flow D
- Flow E
- Flow F
- Flow G

Flow A

Flow A is for the following use case:

- filter HTTP traffic and direct it to the tool(s)
- filter remaining TCP traffic and direct it to the GigaSMART engine for inspection before forwarding it to the tool(s)
- direct all other traffic to the tool(s)

Refer to [Figure 459: FLOW A Views](#) for a larger view of Flow A on the left and a pictorial view on the right.

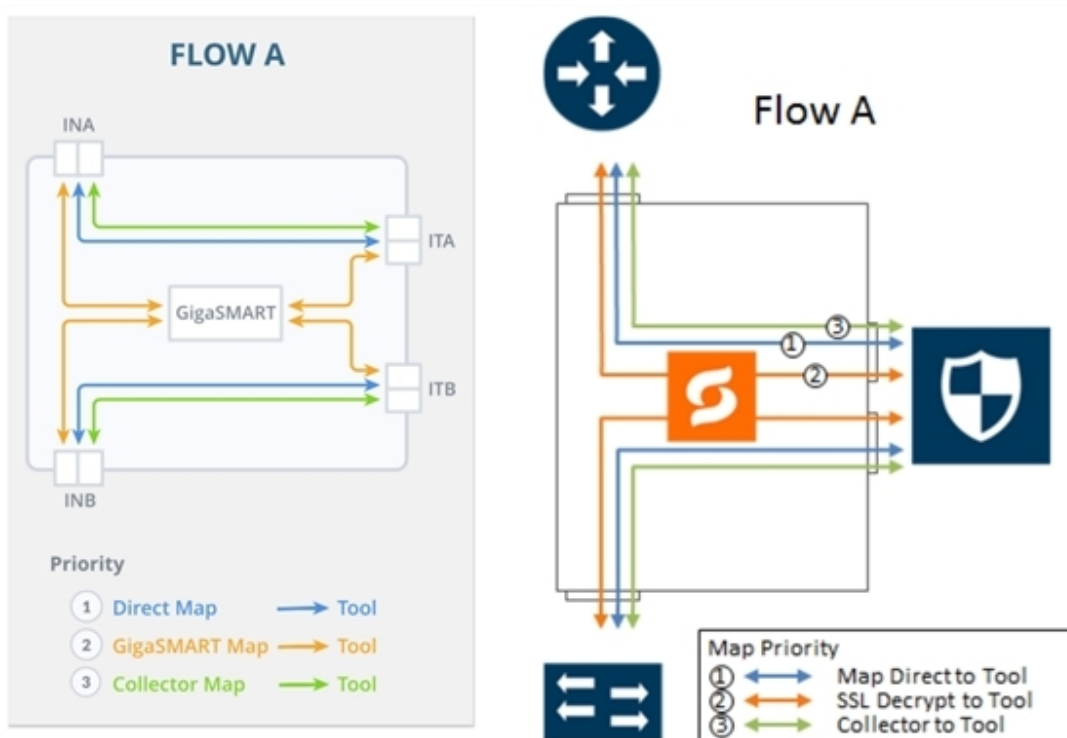


Figure 459: FLOW A Views

The map priorities of Flow A are as follows:

1. limit traffic going to decryption
2. selectively forward traffic for decryption
3. direct unselected traffic to a collector, which sends traffic to tool

Flow B

Flow B is for the following use case:

- filter HTTP traffic and direct it to the tool(s)
- filter remaining TCP traffic and direct it to the GigaSMART engine for inspection before forwarding it to the tool(s)
- bypass all other traffic

Refer to [Figure 460: FLOW B Views](#) for a larger view of Flow B on the left and a pictorial view on the right.

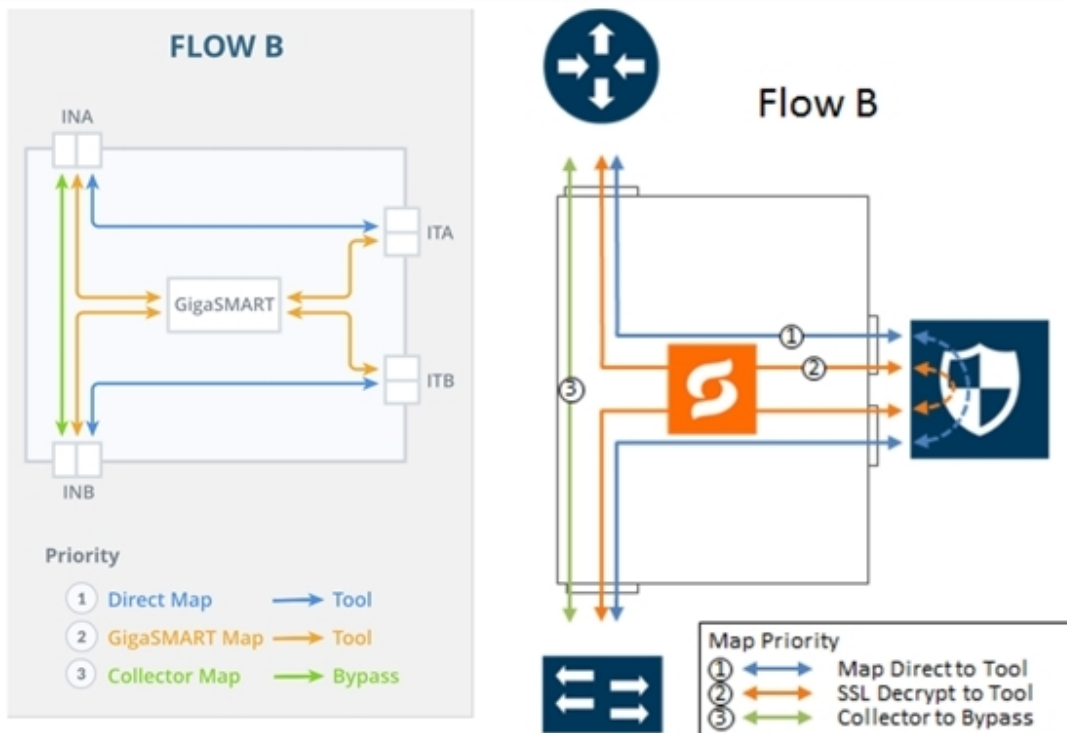


Figure 460: FLOW B Views

The map priorities of Flow B are as follows:

1. limit traffic going to decryption
2. selectively forward traffic for decryption
3. direct unselected traffic to a collector, which sends traffic to bypass

Flow C

Flow C is for the following use case:

- filter traffic from or to certain VLANs (for example, a guest WiFi VLAN) and direct it to bypass
- filter remaining TCP traffic and direct it to the GigaSMART engine for inspection before forwarding it to the tool(s)

- direct all other traffic to the tool(s)

Refer to [Figure 461: FLOW C Views](#) for a larger view of Flow C on the left and a pictorial view on the right.

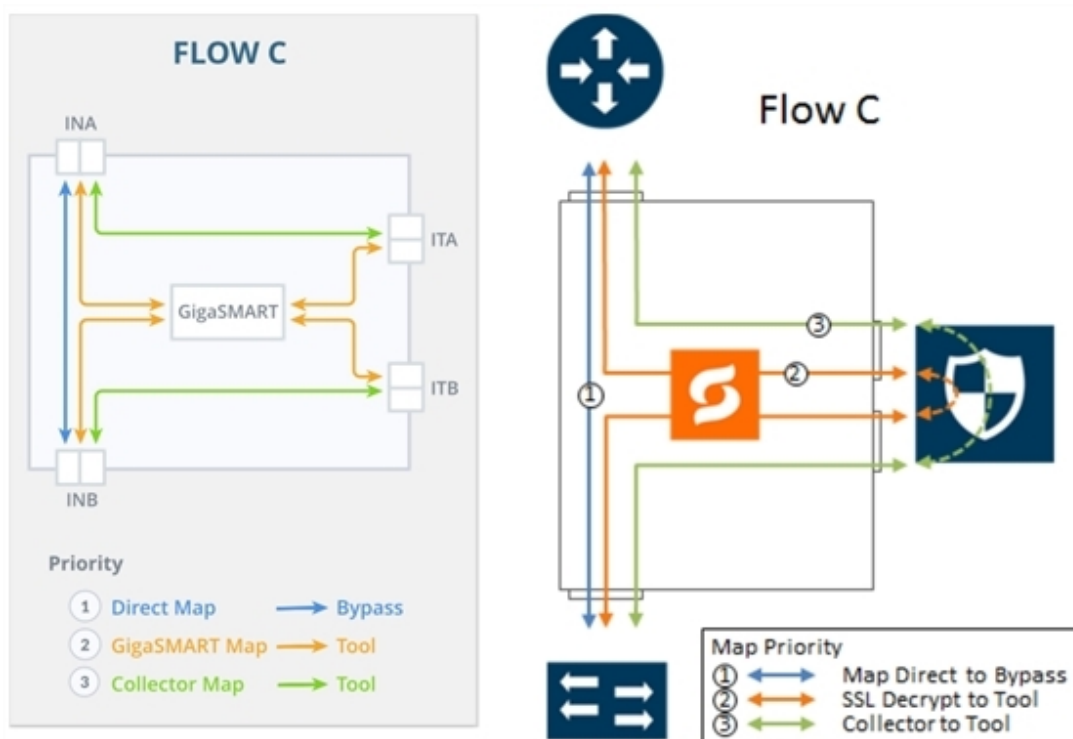


Figure 461: FLOW C Views

The map priorities of Flow C are as follows:

1. send trusted traffic to bypass
2. selectively forward traffic for decryption
3. direct unselected traffic to a collector, which sends traffic to tool

Flow D

Flow D is for the following use case:

- filter traffic from certain VLANs (for example, an employee WiFi VLAN) and direct it to the GigaSMART engine for inspection before forwarding it to the tool(s)
- filter traffic from or to selected internal servers and direct it to bypass
- direct all other traffic to tool(s)

Refer to [Figure 462: FLOW D Views](#) for a larger view of Flow D on the left and a pictorial view on the right.

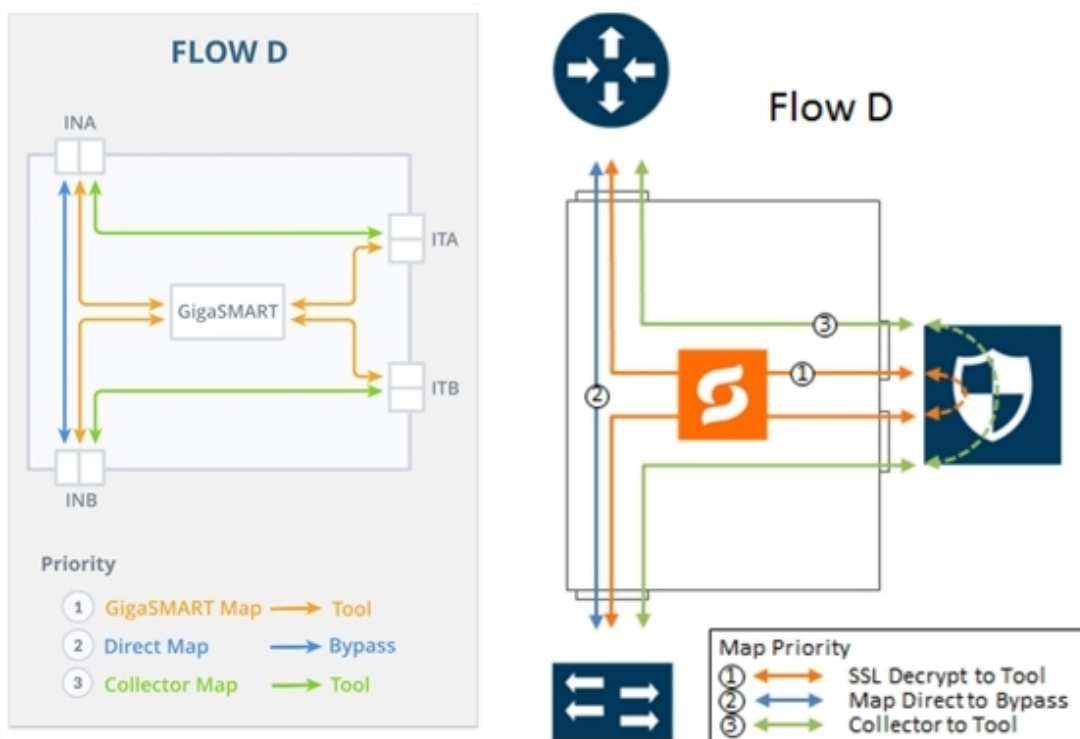


Figure 462: FLOW D Views

The map priorities of Flow D are as follows:

1. selectively forward traffic for decryption
2. send trusted traffic to bypass
3. direct unselected traffic to a collector, which sends traffic to tool

Flow E

Flow E is for the following use case:

- filter traffic from certain VLANs (for example, an employee WiFi VLAN) and direct it to the GigaSMART engine for inspection before forwarding it to the tool(s)
- filter traffic from or to selected internal servers and direct it to the tool(s)
- bypass all other traffic

Refer to [Figure 463: FLOW E Views](#) for a larger view of Flow E on the left and a pictorial view on the right.

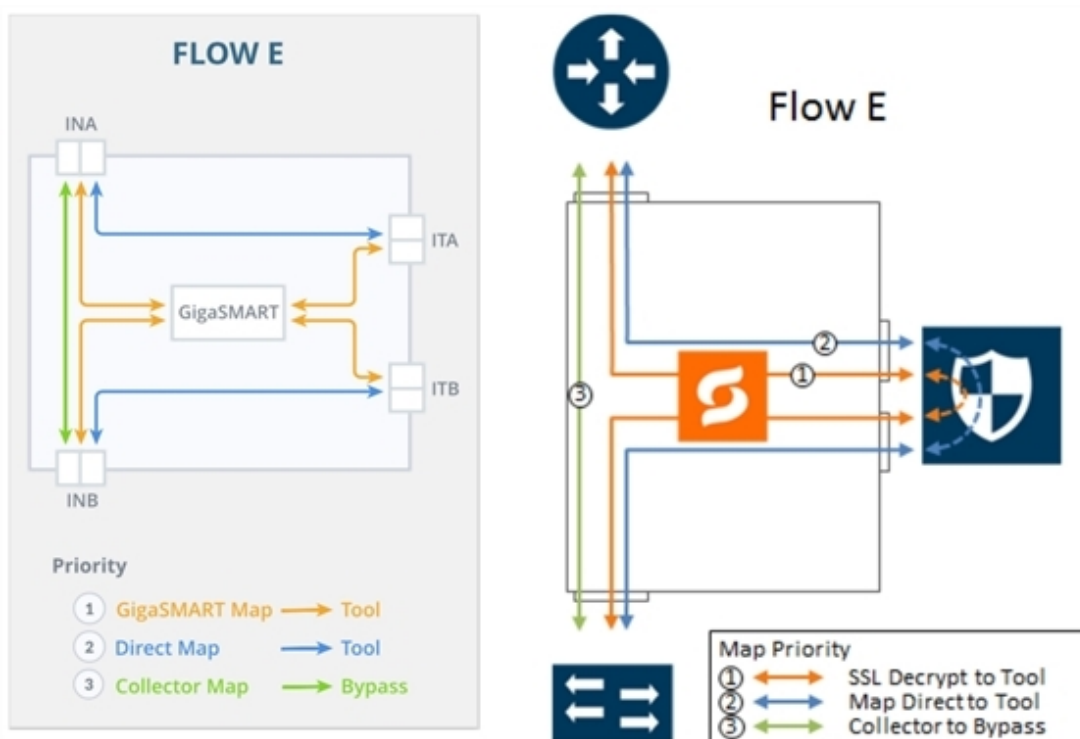


Figure 463: FLOW E Views

The map priorities of Flow E are as follows:

1. selectively forward traffic for decryption
2. send remaining IP traffic to tool(s)
3. direct non-IP traffic to a collector, which sends traffic to bypass

Flow F

Flow F is for the following use case:

- filter TCP traffic and direct it to the GigaSMART engine for inspection before forwarding it to the tool(s)
- direct all other traffic to the tool(s)

Refer to [Figure 464: FLOW F Views](#) for a larger view of Flow F on the left and a pictorial view on the right.

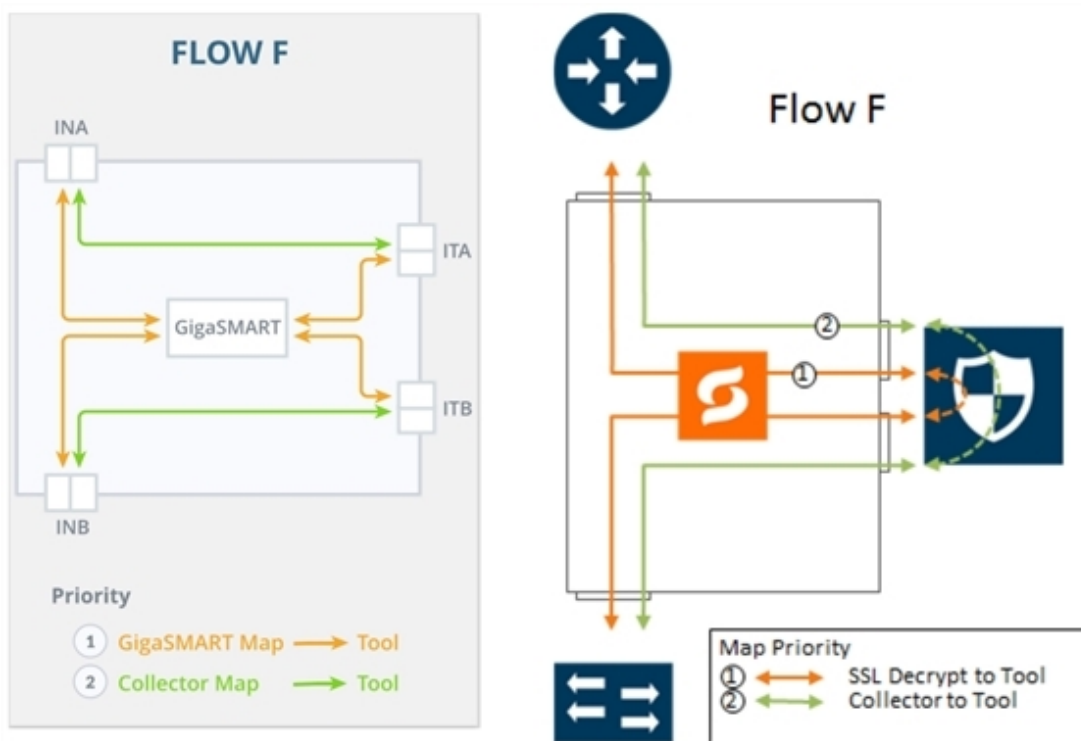


Figure 464: FLOW F Views

The map priorities of Flow F are as follows:

1. selectively forward traffic for decryption
2. direct unselected traffic to a collector, which sends traffic to tool

Flow G

Flow G is for the following use case:

- filter TCP traffic and direct it to the GigaSMART engine for inspection before forwarding it to the tool(s)
- bypass all other traffic

Refer to [Figure 465: FLOW G Views](#) for a larger view of Flow G on the left and a pictorial view on the right.

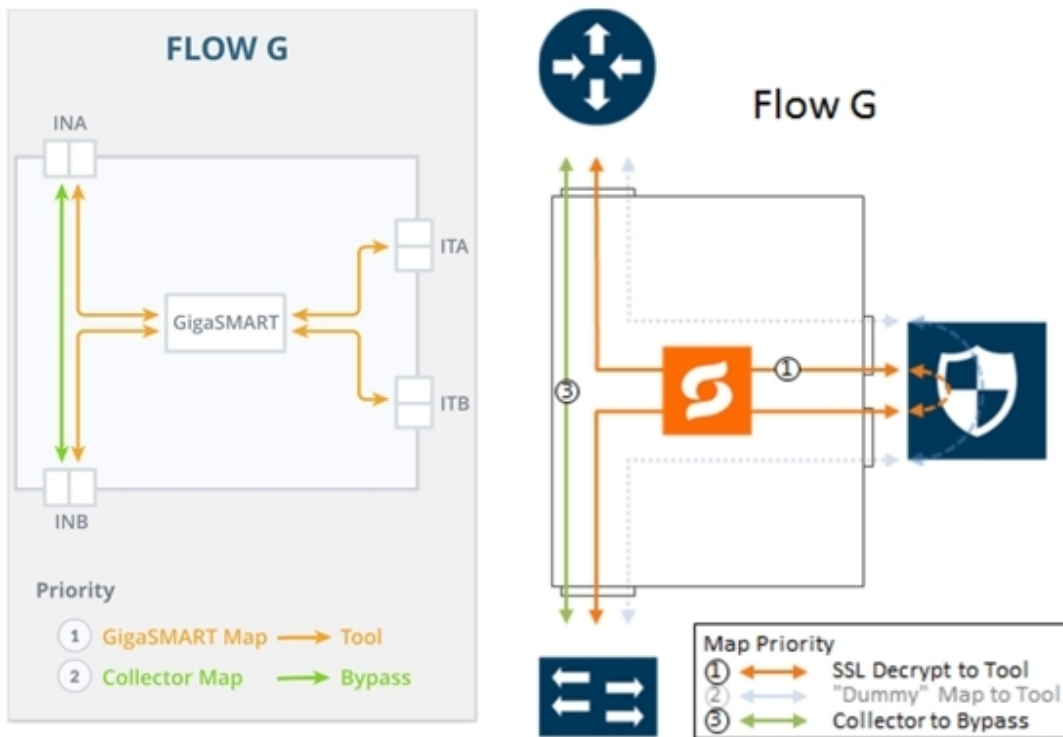


Figure 465: FLOW G Views

The map priorities of Flow G are as follows:

1. selectively forward traffic for decryption
2. direct unselected traffic to a collector, which sends traffic to bypass

Configure Inline SSL Decryption Using GigaVUE-FM

This section describes how to configure inline SSL decryption using GigaVUE-FM.

Before configuring, review [Get Started with Inline SSL Decryption](#) for pre-requisites and review [Introduction to Inline SSL Map Workflows](#).

The Inline SSL Configuration workflow is as follows:

- Keychain Password
- Key Store
- Signing CA
- Trust Store
- Policy Profile
- Network Access

The Inline SSL Map workflow (for Flow B) is as follows:

- Inline Network(s)
- Inline Tool(s)
- GS Group
- Virtual Port
- GS Operation
- Inline Rule Based Map
- Inline First Level Map
- Inline Second Level Map
- Collector Map (bypass)

To configure inline SSL decryption:

1. Go to **Physical Nodes** and select a GigaVUE-HC1, GigaVUE-HC2, or GigaVUE-HC3.
2. Go to **Workflows** and select **Inline SSL Configuration** from the Inline GigaSMART Operations section. Refer to [Figure 457: Select Inline SSL Map Configuration](#).

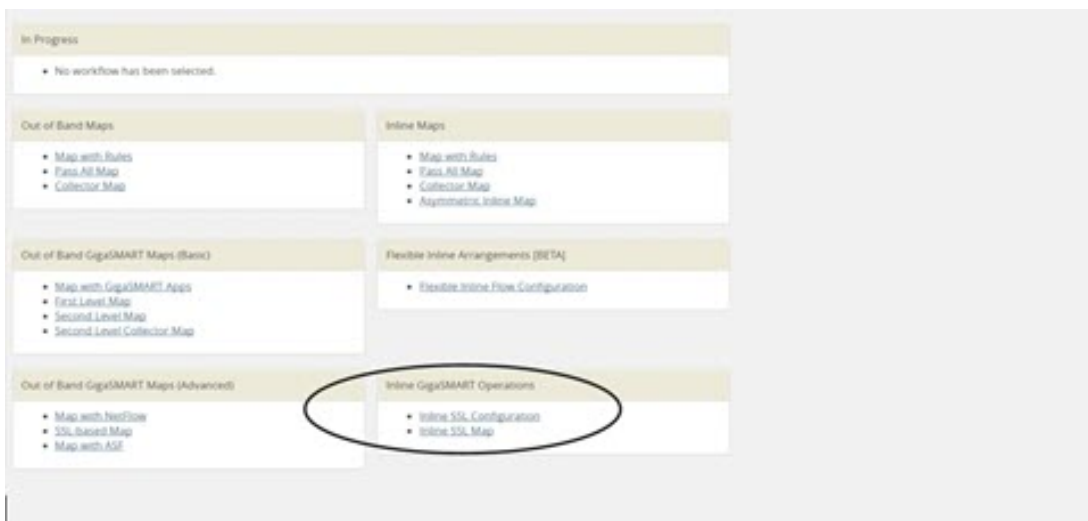


Figure 466: Select Inline SSL Configuration Workflow

3. The first step in the Workflow is **Keychain Password**. Click **Setup Keychain Password** to configure a keychain password.

NOTE: The keychain password must be configured before installing certificates and keys. If the key has a passphrase, in order to install it, the keychain password and the passphrase must match.

4. Enter the Password. Hover the mouse over the ? to review the password requirements. Confirm the password.

5. Click **Submit**. The keychain password is setup.
6. Click **Next**. The next step in the Workflow is **Key Store**.
7. Click **Add Key Pair** to configure the primary signing certificate and private key. The primary CA re-signs certificates for servers that present a valid certificate.
8. Enter an alias for the Key Pair. Click **RSA** or **ECDSA** for Key Type. Click **PEM** or **PKCS12** for Type. Click one of **Copy and Paste**, **Install from URL**, or **Install from Local Directory**.
9. Click **OK**. The Primary Key Pair is added and can be selected from the Key Pair drop-down menu.
10. Still under **Key Store**, repeat Steps 7 to 9 to configure the secondary signing certificate and private key.
11. Click **Next**. The next step in the Workflow is **Signing CA**. Click **Configure Signing CA**.
12. Map each of the key pairs installed to the Primary Root CA and Secondary Root CA.
13. Click **OK**. The signing CA is configured.
14. Click **Next**. The next step in the Workflow is **Trust Store**. No configuration is required if you use the default Trust Store.
15. Click **Next**. The next step in the Workflow is **Policy Profile**. Click **Create** to configure an inline SSL profile. The profile specifies policy configuration, such as certificate handling and actions to take for the profile.
16. Enter an alias for the profile. Under Policy Configuration, select a Default Action of Decrypt. Under Security Exceptions, select Decrypt or Drop.
17. Under Whitelist/Blacklist, select Whitelist and Blacklist. Enter the paths to the files.
18. Under Policy Rules, click **Add a Rule**. Select Category from the Rule drop-down menu. Select financial_services from the Category drop-down menu. Add another rule. Select Category from the Rule drop-down menu. Select health_and_medicine from the Category drop-down menu. Add another rule. Select Domain from the Rule drop-down menu. Enter youtube.com in **Value** text box for the Domain. Click **OK**. The inline SSL profile is added.
19. Click **Next**. The next step in the Workflow is **Network Access**. Click **Configure Network Access**.
20. Select **DHCP** and **DHCP Enabled** for a specified GigaSMART module.
21. Click **OK**. The network access is configured.
22. Go to **Workflows** and select **Inline SSL Map** from the Inline GigaSMART Operations section.
23. Select **FLOW B**.

24. The first step in the Workflow is **Inline Network(s)**. Select a default inline network from the Inline Network(s) drop-down menu. This is a protected inline network.
25. Click **Next**. The next step in the Workflow is **Inline Tool(s)**.
26. Click **Create Inline Tool**. Then click **Port Editor**. In the Quick Port Editor, locate ports and select **Type** of Inline Tool from the drop-down menu. Click **Enable** for those ports.
27. Click **OK**. The inline tool port is added. Click **Close** to exit the Quick Port Editor.
28. Still under **Inline Tool(s)**, enter an alias for the inline tool. Select Port A and Port B from the drop-down menus for the inline tool port pair. Under Configuration, ensure that **Inline tool sharing mode** is selected. Under Heartbeats, select **Enable Regular Heartbeat**.
29. Click **OK**. The inline tool is configured.
30. Click **Next**. The next step in the Workflow is **GS Group**. Click **Create** to configure a GigaSMART group and associate it with a GigaSMART engine port. Enter an alias for the GigaSMART group and select a GigaSMART engine port from the Port List.
31. Click **OK**. The GigaSMART group is added.
32. Click **Next**. The next step in the Workflow is **Virtual Port**. Click **Create** to configure a virtual port.

NOTE: You cannot add multiple vports on the same gsgroup.

33. Enter an alias for the virtual port, select the GigaSMART group configured in Step 30, then select an Inline Failover Action.
34. Click **OK**. The virtual port is added.
35. Click **Next**. The next step in the Workflow is **GS Operation**. Click **Create** to configure a GigaSMART operation.
36. Enter an alias for the GigaSMART operation, select the previously configured GigaSMART group, select Inline SSL as the GigaSMART Operation (GSOP), then select the previously configured Inline SSL profile.
37. Click **OK**. The GigaSMART operation is added.
38. Click **Next**. The next step in the Workflow is **Inline Rule Based Map**.
39. Configure the inline rule-based map. This map directs traffic from the inline network to the inline tool, using a specified rule. It has the same source port as the inline first level map and the same destination port as the inline second level map. Enter an alias for the map, and select the map Type (Inline) and Subtype (By Rule), select the source inline network and the destination inline tool.

40. Click **Add a Rule** to specify a map rule. Click **Bi-directional**, select IPv4 Protocol from the Rule drop-down menu, and select TCP from the Protocol drop-down menu. Select Port Destination from the Rule drop-down menu and enter 80 in the text box for **Min**.
41. Click **OK**. The map is added.
42. Click **Next**. The next step in the Workflow is **Inline First Level Map**.
43. Configure the inline first level map. This map directs TCP traffic from the inline network to a virtual port (and to GigaSMART). Enter an alias for the map, and select the map Type (Inline First Level) and Subtype (Ingress to Virtual Port). Under Map Source and Destination, select the inline network as the source and the virtual port as the destination. Under Map Rules, click **Add a Rule**. Select IPv4 Protocol from the Rule drop-down menu, and select TCP from the Protocol drop-down menu.
44. Click **OK**. The map is added.
45. Click **Next**. The next step in the Workflow is **Inline Second Level Map**.
46. Configure the next map, which is the inline second level map. This map directs traffic from the virtual port, uses the inline SSL GigaSMART operation, and sends traffic to the inline tool. Enter an alias for the map and select the map Type (Inline Second Level) and Subtype (Egress from Virtual Port). Under Map Source and Destination, select the virtual port as the source and the inline tool as the destination, then select the inline SSL GigaSMART operation.
47. Click **OK**. The map is added.
48. Click **Next**. The next step in the Workflow is **Collector Map (bypass)**.
49. Configure a collector map for any unmatched traffic including non-TCP traffic, which is directed to bypass. Enter an alias for the map, and select the map Type (Inline) and Subtype (Collector), then select a Traffic Path of ByPass. Under Map Source and Destination, select the inline network as the source.
50. Click **OK**. The map is added.
51. Click **To Maps** when the workflow is complete.
52. Verify the maps created by the workflow.
53. For inline network ports, go to **Inline Bypass > Inline Networks**. Select the inline network port and click **Edit**. Under Configuration, select a traffic path of To Inline Tool. If using protected inline networks, disable Physical Bypass.

View Statistics

You can view the following inline SSL decryption statistics:

- [Inline SSL Session Statistics](#)
- [Monitor Statistics](#)

- Certificate Statistics

Inline SSL Session Statistics

To display inline SSL session statistics, go to **GigaSMART > Inline SSL > Session Statistics**. Refer to [Figure 467: Inline SSL Session Statistics in FM](#).

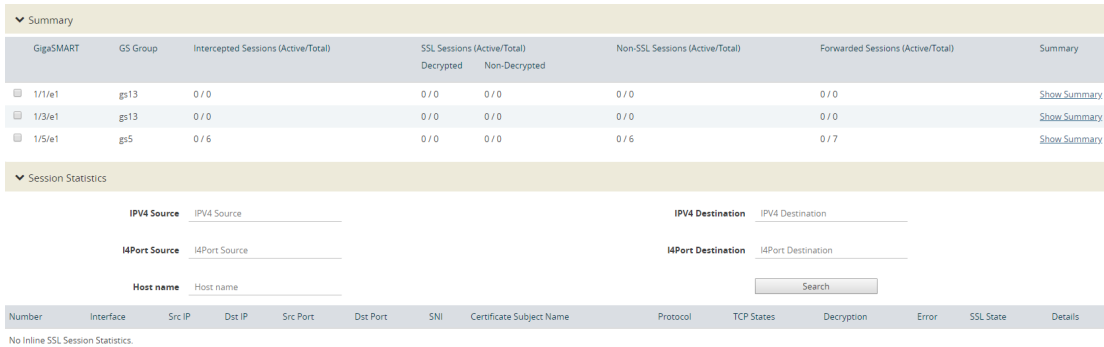


Figure 467: Inline SSL Session Statistics in FM

To display the inline SSL summary details, go to **GigaSMART > Inline SSL > Session Statistics**, view the Summary section, then click **Show Summary**. There are four sections: Session Statistics, Performance Statistics, Policy Statistics, and Certificate Statistics.

To search the inline SSL session statistics, go to **GigaSMART > Inline SSL > Session Statistics**. Enter an IPv4 source or destination, an L4 port source or destination, or a host name on which to search the session statistics.

Monitor Statistics

To display monitor statistics, go to **GigaSMART > Inline SSL > Monitor Statistics**.

There are three sections. The first section, which has a graph for INTERFACE TRAFFIC and Interface Packet statistics, is displayed initially. To return to this display, click the small graph, TOTAL INCOMING PACKETS. Refer to [Figure 468: Inline SSL Session Monitor—Interface Packet Statistics](#).

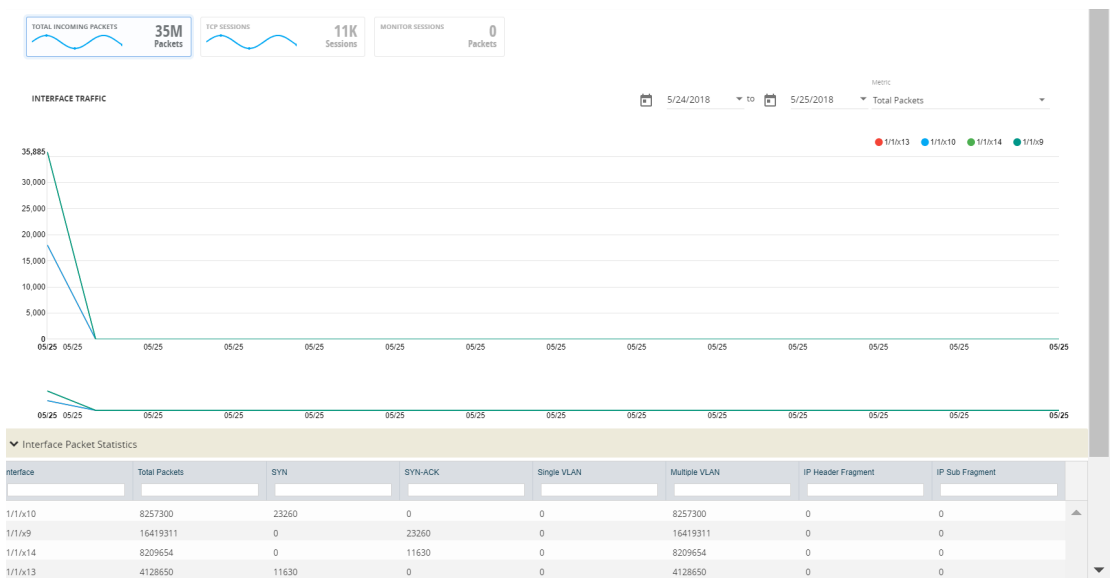


Figure 468: Inline SSL Session Monitor—Interface Packet Statistics

To display the graph and statistics for TCP Sessions, click the small graph, TCP SESSIONS. Refer to [Figure 469: Inline SSL Session Monitor—TCP Sessions](#).



Figure 469: Inline SSL Session Monitor—TCP Sessions

To display Monitor Sessions, click the small graph, MONITOR SESSIONS. Refer to [Figure 470: Inline SSL Session Monitor—Monitor Sessions](#).

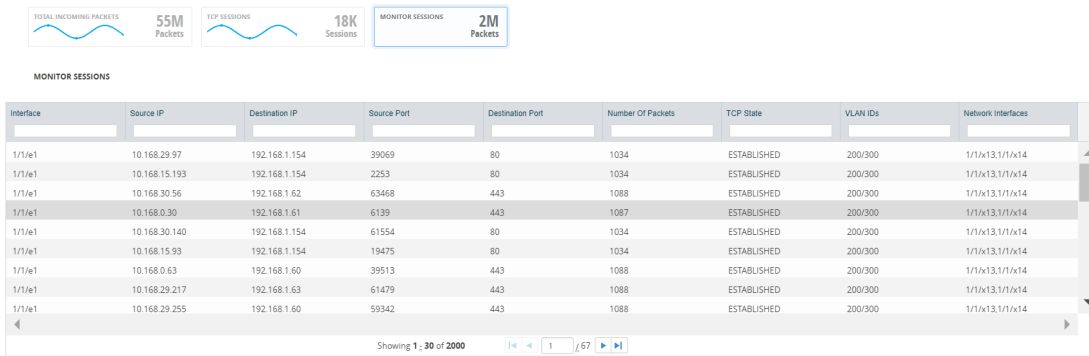


Figure 470: Inline SSL Session Monitor—Monitor Sessions

Certificate Statistics

To view certificate statistics, go to **GigaSMART > Inline SSL > Certificate Statistics**. The page displays the hit count of each key store certificate and allows to track whether the certificate is actively used or not. The hit count is numbered only if the policy is set for decryption. If the policy is set to no-decryption or if the deployment is outbound, the hit count will not be considered.

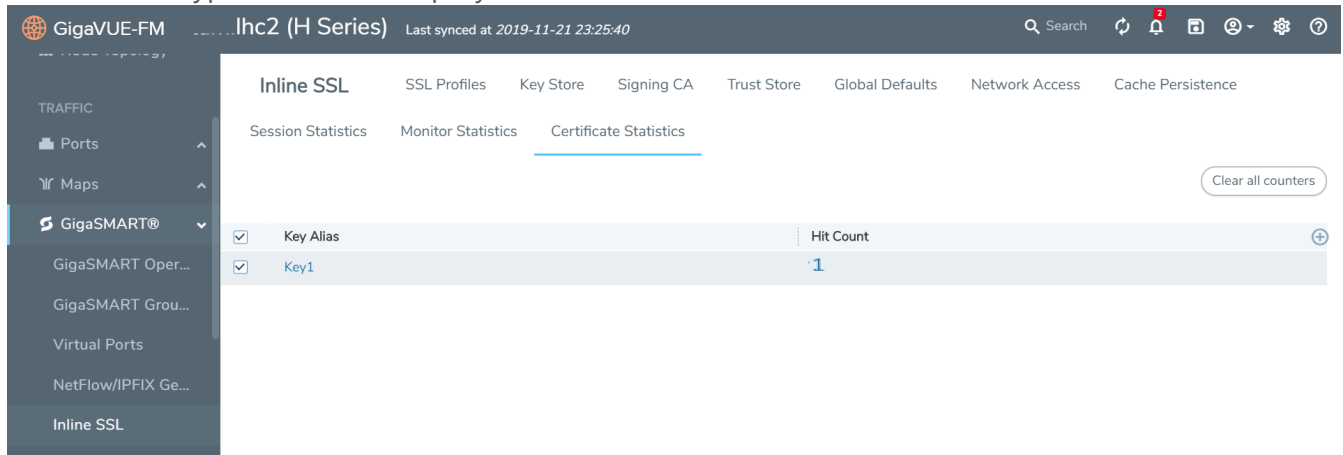


Figure 471: Inline SSL - Certificate Statistics

Click **Clear all Counters** to clear the hit counter of all the certificates.

GigaSMART Out-of-Band SSL Decryption

Required License: SSL Decryption for Out-of-Band

GigaVUE H Series nodes support Secure Sockets Layer (SSL) decryption. SSL is a cryptographic protocol that adds security to TCP/IP communications such as Web browsing and email. The protocol allows the transmission of secure data between a server and client who both have the keys

to decode the transmission and the certificates to verify trust between them. Out-of-band SSL decryption delivers decrypted traffic to out-of-band tools that can then detect threats entering the network.

Out-of-band SSL decryption is a pillar of the GigaSECURE Security Delivery Platform. For an overview of GigaSECURE, refer to [GigaSECURE Security Delivery Platform](#).

On GigaVUE H Series nodes, GigaSMART line cards or modules perform the decryption of SSL traffic. Using GigaSMART for decryption offloads the decryption function from tools and offers improved tool performance by removing this computationally intensive task. GigaSMART provides a centralized decryption point. Decrypted SSL traffic can be sent from GigaSMART to inspection tools for further analysis, for example, to look at encrypted communications or to detect malware.

Before SSL traffic is decrypted, the de-duplication GigaSMART operation can be performed. Decrypted traffic from the GigaSMART line card or module can be filtered, aggregated, and replicated and then sent to one or more monitoring tools for analysis.

Out-of-band SSL decryption is supported on the following GigaVUE H Series products with GigaSMART line cards or modules installed:

- GigaVUE-HC3
- GigaVUE-HC2
- GigaVUE-HC1

Use out-of-band SSL decryption on the GigaSMART line card or module with passive or offline traffic. Tap the traffic to and from a server and pass it to the GigaVUE H Series node with the GigaSMART line card or module.

Out-of-band SSL decryption operations can be assigned to GigaSMART groups consisting of multiple engine ports. Refer to [Groups of GigaSMART Engine Ports](#) for details.

For secure storage of private keys, NCipher Hardware Security Module (HSM) is integrated with out-of-band SSL decryption. Refer to [NCipher HSM for SSL Decryption for Out-of-Band Tools](#) for details.

Gigamon also offers inline SSL decryption, which inspects SSL encrypted traffic inline. Refer to [Inline SSL Decryption](#) for details.

About Out-of-Band SSL Decryption

SSL encryption secures traffic between a client and a server, such as a Web server. SSL decryption uses keys to decode the traffic between the client and server.

SSL and Transport Layer Security (TLS) protocols consist of a set of messages exchanged between a client and server to set up and tear down the SSL connection between them. To set up the connection, the client and server use the Public Key Infrastructure (PKI) to exchange the bulk encryption keys needed for data transfer.

Figure 472: Basic SSL Handshake shows the basic SSL handshake between a client and server to establish a session. The messages are unencrypted up to step 6 in Figure 472: Basic SSL Handshake. The messages are encrypted after step 6, including the step 9 Finished message.

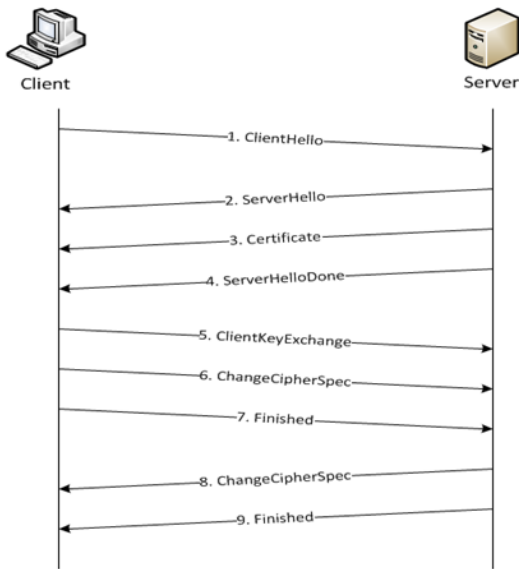


Figure 472: Basic SSL Handshake

Once a session has been established, the keys are saved so a session can be resumed efficiently later. Figure 473: Resumed SSL Handshake shows the resumed SSL handshake, with fewer steps.

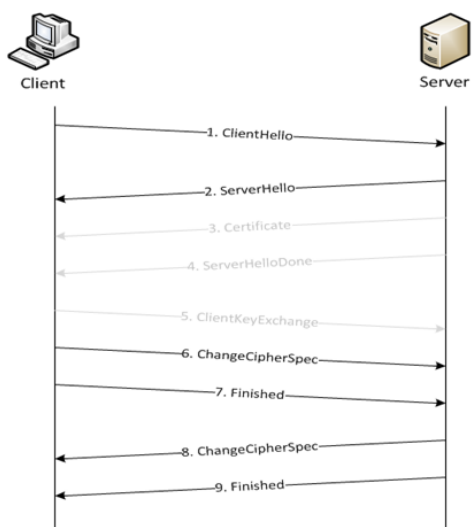


Figure 473: Resumed SSL Handshake

Out-of-band SSL decryption can be deployed close to the server, as shown in [Figure 474: Inbound \(Server Side\)](#).

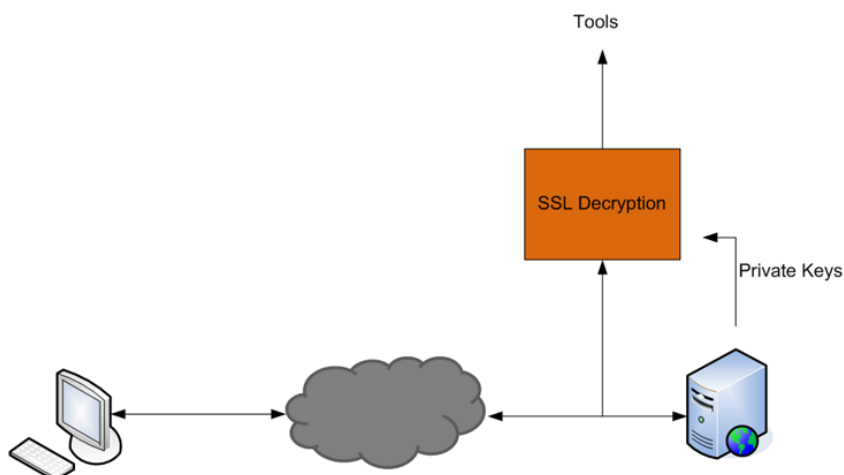


Figure 474: Inbound (Server Side)

Out-of-band SSL decryption can also be deployed close to an SSL proxy, with the server in the Enterprise domain as shown in [Figure 475: Outbound \(Client/Enterprise Side\)](#).

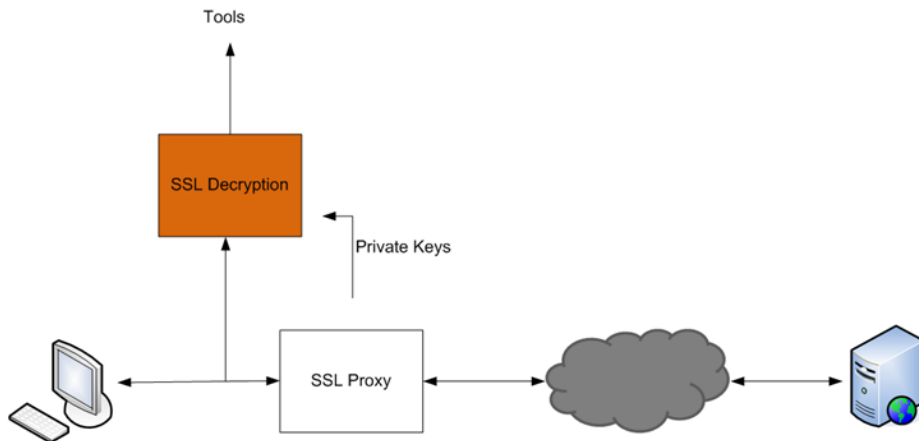


Figure 475: Outbound (Client/Enterprise Side)

In [Figure 474: Inbound \(Server Side\)](#), tap traffic to the server and then send it for decryption. In [Figure 475: Outbound \(Client/Enterprise Side\)](#), tap traffic to the proxy and then send it for decryption. You can have a deployment with either a server or a proxy, but not both.

The following sections describe out-of-band SSL decryption on GigaSMART:

- [Supported Protocols, Algorithms, and Ciphers](#)
- [Limitations](#)
- [Create and Reset Passwords](#)
- [Work with Keys and Services](#)
- [Configuring SSL Decryption Examples on page 613](#)

Supported Protocols, Algorithms, and Ciphers

The supported protocols are as follows:

- SSL 3.0
- TLS 1.0
- TLS 1.1
- TLS 1.2

The supported authentication (Au) is as follows:

- RSA

The supported key exchange (Kx) is as follows:

- RSA

The supported encryption algorithms (Enc) are as follows:

- NULL
- RC4
- DES
- 3DES
- AES (including GCM mode)
- CAMELLIA
- SEED
- IDEA

The supported compression algorithm is as follows:

- NULL

The supported digest algorithms are as follows:

- MD5
- SHA1
- SHA2

The supported key sizes are 128, 256, 512, 1024, 2048, and 4096.

The supported TLS extensions are as follows:

- Extended Master Secret, RFC 7627
- Encrypt-then-MAC, RFC 7366

The supported ciphers are listed in [Table 70: Supported Ciphers for Out-Of-Band SSL decryption](#).

Table 70: Supported Ciphers for Out-Of-Band SSL decryption

Cipher Name	Kx	Au	Enc	Bits	Mac
TLS_RSA_WITH_NULL_MD5	RSA	RSA	NULL	0	MD5
TLS_RSA_WITH_NULL_SHA	RSA	RSA	NULL	0	SHA
TLS_RSA_EXPORT_WITH_RC4_40_MD5	RSA_EXPORT	RSA_EXPORT	RC4_40	40	MD5
TLS_RSA_WITH_RC4_128_MD5	RSA	RSA	RC4_128	128	MD5
TLS_RSA_WITH_RC4_128_SHA	RSA	RSA	RC4_128	128	SHA
TLS_RSA_EXPORT_WITH_RC2_CBC_40_MD5	RSA_EXPORT	RSA_EXPORT	RC2_CBC_40	40	MD5

Cipher Name	Kx	Au	Enc	Bits	Mac
TLS_RSA_WITH_IDEA_CBC_SHA	RSA	RSA	IDEA_CBC	128	SHA
TLS_RSA_EXPORT_WITH_DES40_CBC_SHA	RSA_EXPORT	RSA_EXPORT	DES40_CBC	40	SHA
TLS_RSA_WITH_DES_CBC_SHA	RSA	RSA	DES_CBC	56	SHA
TLS_RSA_WITH_3DES_EDE_CBC_SHA	RSA	RSA	3DES_EDE_CBC	168	SHA
TLS_RSA_WITH_AES_128_CBC_SHA	RSA	RSA	AES_128_CBC	128	SHA
TLS_RSA_WITH_AES_256_CBC_SHA	RSA	RSA	AES_256_CBC	256	SHA
TLS_RSA_WITH_CAMELLIA_128_CBC_SHA	RSA	RSA	CAMELLIA_128_CBC	128	SHA
TLS_RSA_WITH_CAMELLIA_256_CBC_SHA	RSA	RSA	CAMELLIA_256_CBC	256	SHA
TLS_RSA_WITH_SEED_CBC_SHA	RSA	RSA	SEED_CBC	128	SHA
TLS_RSA_WITH_NULL_SHA256	RSA	RSA	NULL	0	SHA256
TLS_RSA_WITH_AES_128_CBC_SHA256	RSA	RSA	AES_128_CBC	128	SHA256
TLS_RSA_WITH_AES_256_CBC_SHA256	RSA	RSA	AES_256_CBC	256	SHA256
TLS_RSA_WITH_AES_128_GCM_SHA256	RSA	RSA	AES_128_GCM	128	SHA256
TLS_RSA_WITH_AES_256_GCM_SHA384	RSA	RSA	AES_256_GCM	256	SHA384

All algorithms used for out-of-band SSL decryption are FIPS 140-2 compliant.

All key URLs must point to an RSA private key stored in the PEM or PKCS12 format, as follows:

- <http://keyserver.domain.com/path/keyfile.pem>
- <https://keyserver.domain.com/path/keyfile.pem>
- <ftp://keyserver.domain.com/path/keyfile.pem>
- <tftp://keyserver.domain.com/path/keyfile.pem>
- [scp://username\[:password\]@keyserver.domain.com/path/keyfile.pem](scp://username[:password]@keyserver.domain.com/path/keyfile.pem)

The supported applications are as follows:

- HTTPS
- FTPS
- SMTP, IMAP, and POP3 with StartTLS

Limitations

The following are limitations of out-of-band SSL decryption:

- Only IPv4.
- Only regular maps; no virtual ports (vports).
- Only combined with the de-duplication GigaSMART operation.
- Only one private key per PKCS12 file.
- Only server-side authentication.
- Only the protocols and ciphers listed in [Supported Protocols, Algorithms, and Ciphers](#). If an SSL session cannot be decrypted due to having a non-supported protocol or cipher, the packets will be forwarded to the tool without decryption if the GS Parameter **SSL Decryption** has **Decrypt Fail Action** is set to **Pass to Tool Port**. Non-supported ciphers and protocols include SSL 2.0, TLS 1.3, Diffie-Hellman (DHE keys), Ephemeral keys, Elliptic Curves Extension, compression, and 8K key size.

Licensing

The GigaSMART license for out-of-band SSL decryption is installed as any other license.

There are no limits to the number of out-of-band SSL decryption sessions or the number of users.

Create and Reset Passwords

To perform the configuration in the following section, you must have an admin level access role.

Before uploading keys or configuring SSL, you must create an SSL keychain password. The password is used to encrypt the private keys that you upload to the node.

Keychain passwords are not saved on the node. Refer to [Notes about Private Keys and Passwords](#).

NOTE: When uploading SSL keys, make sure that you are not creating a duplicate key. Adding a duplicate key can cause errors.

To create an SSL keychain password, use the following steps:

1. From the device view, select **GigaSMART > Passive SSL > Key Store**.
2. Click **Keychain Password**.

The set-up page shown in figure [Figure 476: SSL Keychain Password Setup Page](#) displays.

Figure 476: SSL Keychain Password Setup Page

3. Enter a password in the **Password** and **Confirm Password** fields.

You can only configure a strong password. A strong password has at least ten (10) characters and at least three (3) of the following:

- uppercase letters
- lowercase letters
- numbers
- special characters

4. Click **Submit**.

After keys are installed on the node, you will be prompted to enter the password after any login as well as after a node reboot, for example:

If you are a user who does not have an admin level access role, when you enter the configure terminal mode, the following message is displayed:

Password required. Please contact administrator.

If you are a user with an admin level access role, but you enter an incorrect password, the following message is displayed:

Password does not match. Please reenter the password

If an SSL keychain password is lost, it can be reset, but all existing private keys will be revoked. When there are keys installed on the node, a warning is displayed before you are prompted for the new password.

Once you have a new password, you will have to upload the keys again.

Work with Keys and Services

This section describes working with private keys as well as services. Keys must be uploaded to the GigaVUE H Series node using a unique alias. Services must be defined for each server destination that needs decryption.

To perform the configuration in the following section, you must have an admin level access role.

Encrypted private keys are saved on the node. Refer to [Notes about Private Keys and Passwords](#).

NOTE: When uploading SSL keys, make sure that you are not creating a duplicate key. Adding a duplicate key can cause errors.

Upload SSL Private Keys

To upload an SSL private key, do the following:

1. From the device view, select **GigaSMART > Passive SSL > Key Store** to open the Key Store page shown in [Figure 477: SSL Key Store Page](#).

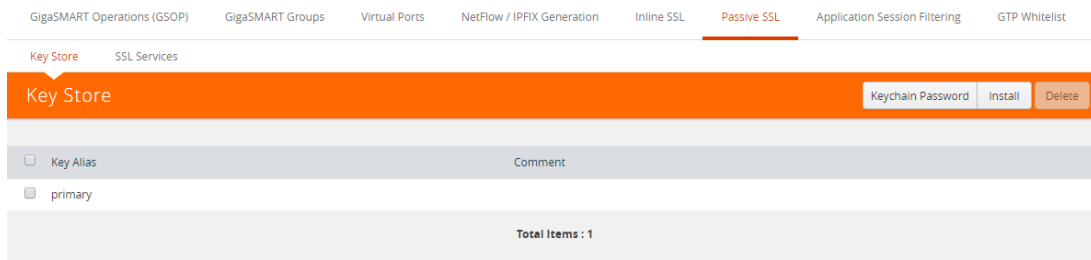


Figure 477: SSL Key Store Page

2. Click **Install**. The SSL Key page appears.

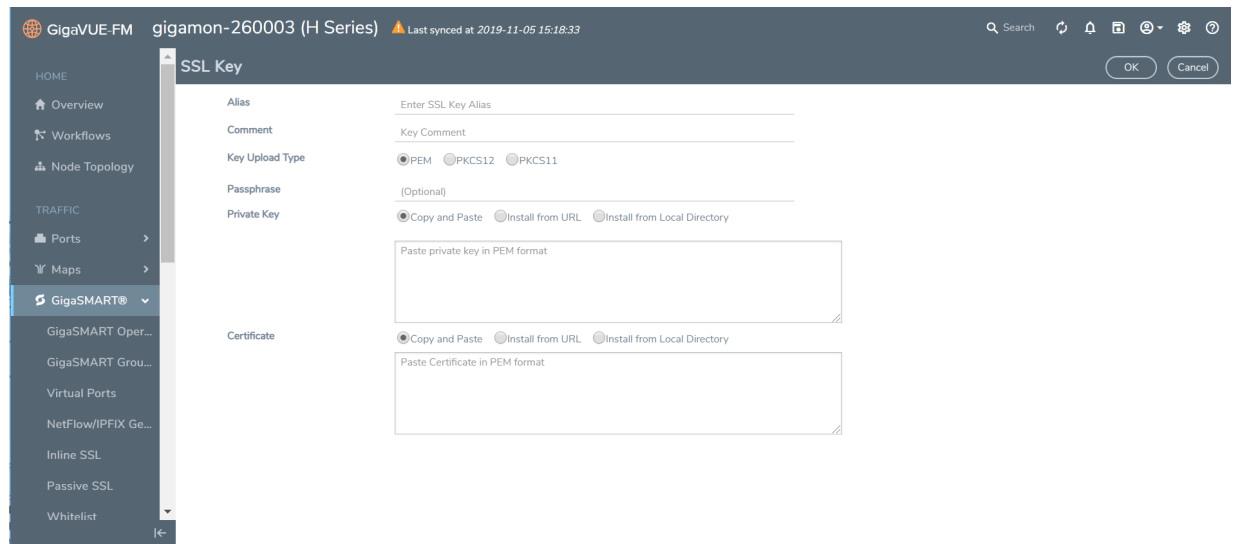


Figure 478: SSL Key Page

3. In the **SSL Key** page,
 - For **Alias**, enter an alias for the SSL key.
 - For **Comment**, enter any additional information for the SSL key.
 - For **Key Upload Type**, select **PEM**, **PKCS12** or **PKCS11**.
 - (optional) For **Passphrase**, enter a passphrase for the key.
 - Select a **Private Key** by pasting the copied key in PEM format or installing from URL or installing from local directory.
 - Select a **Certificate** by pasting the copied key in PEM format or installing from URL or installing from local directory.

NOTE:

- You can either use the server certificate or the private key to decrypt a passive SSL traffic.
- If the [Enable Default Service to identify all IP addresses and server ports](#) is enabled in SSL Service, you can not use the server certificate to decrypt Passive SSL traffic.

4. Click **OK**.

If you choose to use Venafi, Inc. as your Electronic Key Management System (EKMS), ensure that you have the GigaVUE-FM host address and credentials to push the generated key into the selected nodes. For details on pushing keys from Venafi, contact either Venafi or Gigamon customer support.

Delete SSL Key

To delete a particular SSL private key, select the key on the SSL Keys page, and then select Delete. To delete all SSL private keys, select multiple keys.

Create SSL Service

After you have uploaded a private key, you can add a service. A service maps to a physical server, such as an HTTP server. One server can run multiple services. A service is a combination of an IP address and a server port number. Also, the key and the service must be tied together. Refer to [Configuring SSL Decryption Examples on page 613](#) for examples.

Prerequisites

Before creating a service, you must do the following:

- Upload a private key as described in [Uploading SSL Private Keys](#)
- Create GigaSMART Group with SSL Decryption enabled.

To create a service, do the following:

1. From the device view, select **GigaSMART > Passive SSL > SSL Services**. The SSL Services page displays as shown in [Figure 479: SSL Services Page](#).

<input type="checkbox"/>	Server Alias	Server IP Address	Server Port	Key Alias	GS Group
<input type="checkbox"/>	def	0.0.0.0	0	-	-
<input type="checkbox"/>	ssl1	11.1.1.1	0	key4k	gs
<input type="checkbox"/>	srv1	1.1.1.10	0	key1	gs
<input type="checkbox"/>	srv10	1.1.1.9	0	key10	gs
<input type="checkbox"/>	srv100	1.1.1.99	0	key100	gs
<input type="checkbox"/>	srv1000	1.1.6.99	0	key1000	gs
<input type="checkbox"/>	srv1001	1.1.6.100	0	key1001	gs
<input type="checkbox"/>	srv1002	1.1.6.101	0	key1002	gs
<input type="checkbox"/>	srv1003	1.1.6.102	0	key1003	gs
<input type="checkbox"/>	srv1004	1.1.6.103	0	key1004	gs

Showing 1 - 10 of 2002. | < > 1 2 3 4 5 >> |

Figure 479: SSL Services Page

2. Click **New**.
3. On the SSL Service configuration page, do the following:
 - Enter an alias.
 - Enter the information for the service: IP Address, Server Port.
 - Select the alias of SSL Key previously uploaded. For the steps, refer to [Uploading SSL Private Keys](#).
 - Select the GigaSMART Group with SSL decryption enabled to associate with this SSL service.

[Figure 480: SSL Service Settings](#) shows an example of an SSL Service.

4. Click **OK**.

SSL Service Save Cancel

Alias: sslserv1

Default Service: Enabled

Server IP Address: 0.0.0.0

Server Port: 0

SSL Key Alias: ssl1

GS Group: gsgrp1

Figure 480: SSL Service Settings

DeleteService

To delete a particular SSL service select the service on the SSL Services page, and then select Delete. To delete all SSL services, select multiple keys.

Notes about Private Keys and Passwords

Consider the following notes about private keys and passwords:

- Encrypted private keys are stored on the node. When a private key is uploaded, it is encrypted with a password before it is stored, therefore keys are password-protected. Keychain passwords are not stored on the node.
- Because only encrypted private keys are stored on the node and because the keychain password is not stored on the node, after any node reboot you will be prompted to enter the password. Until the password is entered, out-of-band SSL decryption is not working.
- Key content cannot be displayed.
- Keys that are synchronized across a cluster are encrypted.

ECODES for Troubleshooting Out-of-Band SSL Decryption

Use the following table of ECODE messages to assist with troubleshooting out-of-band SSL decryption:

ECODE	Description
81	TCP flow errors detected. Make sure you see the complete TCP flow. Use the de-duplication GigaSMART operation with out-of-band SSL decryption.
103	Session limit reached. The session table has been exhausted. If the session timeout (session-timeout) value is large, lower it.
104	Key/ticket cache limit reached. The allocated cache entries have been used up. If the timeout (key-cache-timeout or ticket-cache-timeout) value is large, lower it.
206	No server info. A flow has been received for which service-key mapping is not defined.
213	Packets for missed TCP handshake. Packets were received for TCP flows that do not exist. If the device was just started, this should trend down quickly.
218	Unknown SSL version. An SSL handshake processing error occurred. Use the de-duplication GigaSMART operation with out-of-band SSL decryption.
221	Unknown SSL version. An unsupported SSLv2 handshake was seen.
222	Protocol error. An unsupported protocol version was seen.
225	Unsupported cipher. The cipher suite cannot be decrypted.
226	Pre-master secret error. Check that the private key is correct and that the session is complete.
228	Generic decryption error. Usually indicates errors in the handshake. Check that you are getting the full session from both sides.
231	Invalid MAC. Likely indicates that invalid or truncated packets have been received.

ECODE	Description
232	Session not in cache. Indicates that you are trying to decrypt a restarted session where the original negotiation was not seen. These should trend down in time, but if they do not, increase the key-cache-timeout value.
237	Cannot decrypt ephemeral key based encryption. One of the Ephemeral/PFS ciphersuites, usually Diffie-Hellman Ephemeral, has been seen. These are not supported.
245	Ticket not in cache. This is usually not an error. Indicates that you are trying to decrypt a restarted session where the original negotiation was not seen. These should trend down in time, but if they do not, increase the ticket-cache-timeout value.

Display Out-of-Band SSL Decryption Flow Ops Report

To display the Flow Ops report for out-of-band SSL decryption:

1. From the device view, select **GigaSMART > GigaSMART Groups > Report**. The Report page displays as shown in [Figure 481: Report Page](#).

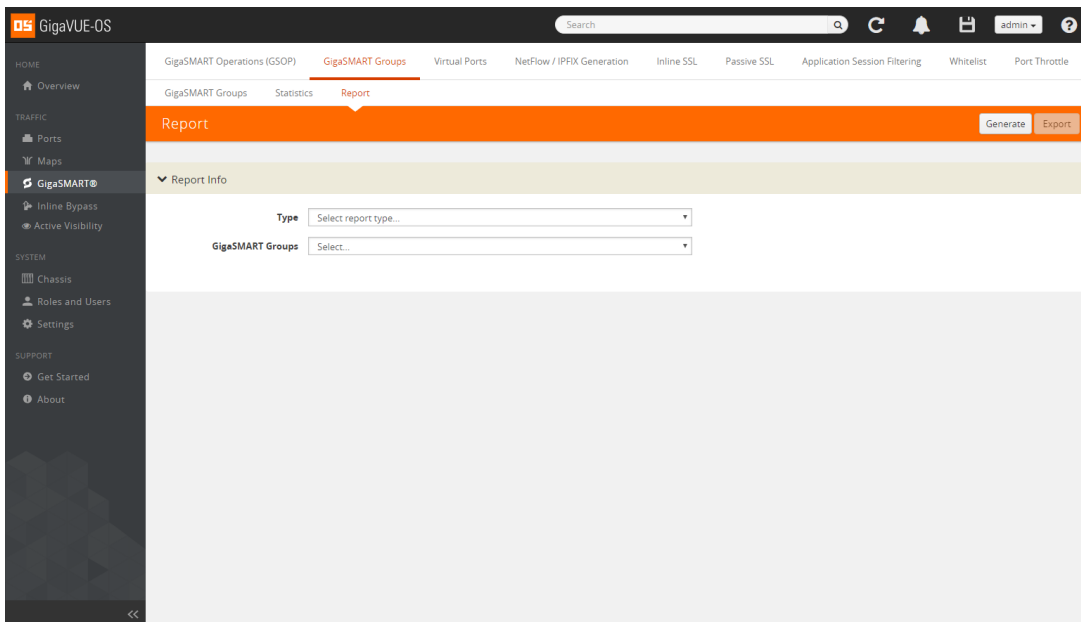


Figure 481: Report Page

2. Select report type **SSL Decryption** and select a GigaSMART group from the drop-down menu.
3. Click **Generate**. The SSL Decryption Report Summary displays as shown in [Figure 482: SSL Decryption Report Summary](#).

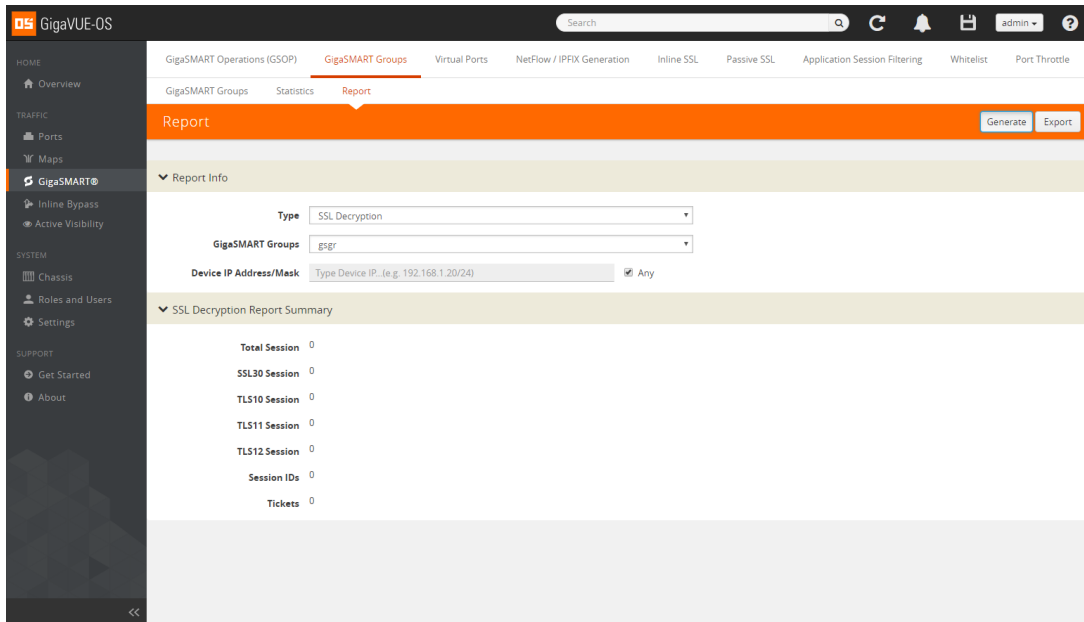


Figure 482: SSL Decryption Report Summary

The fields in the SSL Decryption Report Summary are as follows:

- Total Session—The total number of out-of-band SSL decryption sessions.
- SSL30 Session—The cumulative total number of SSL 3.0 sessions.
- TLS10 Session—The cumulative total number of TLS 1.0 sessions.
- TLS11 Session—The cumulative total number of TLS 1.1 sessions.
- TLS12 Session—The cumulative total number of TLS 1.2 sessions.
- Session IDs—The number of concurrent session IDs.
- Tickets—The number of current TLS tickets.

NCipher HSM for SSL Decryption for Out-of-Band Tools

Required License: Included with SSL Decryption for Out-of-Band Tools

Starting in software version 5.3, NCipher Hardware Security Module (HSM) is integrated with out-of-band SSL decryption. Hardware Security Modules offer secure storage, management, and operation of cryptographic material, such as private keys and passphrases. The HSM stores and manages the keys in a safe and secure environment. Since the keys reside on the HSM in the network, they are offloaded from an application on a network device.

The application could be a web server or a database server, but, in the case of SSL decryption for out-of-band tools, the application is GigaSMART. The application interfaces with HSM to use the keys that are stored. There must be network connectivity between the HSM and the application.

Keys are added to the HSM by an administrator. When an application's key is on the HSM, the HSM creates an application key token. The key token is sent to the application. When the application wants to use a key, the application sends the token to HSM, which establishes a session with the HSM to use the key. In this way, the use of keys by the application is secure because only key tokens are exchanged.

NCipher HSM is supported on GigaVUE-HC1, GigaVUE-HC2, and GigaVUE-HC3.

Refer to the following limitations:

- GigaSMART uses keys that are already stored on the HSM. There is no key generation.
- The key token that is uploaded to GigaSMART can only be in PKCS11 format.
- Only RSA keys (private keys) are supported.
- Keys are module-protected. With module-protection, the application is a registered client that does not need to log in to the HSM.
- The network connectivity between the HSM and GigaSMART must use a static IP address. Do not use DHCP because the IP address needs to remain the same.
- Only IPv4 addresses are supported.
- Each GigaSMART card that interfaces with the NCipher HSM will use one NCipher license.
- Clustering is not supported.

Refer to the following section for details:

- [Configure HSM](#)

Configure HSM

This section provides information about the steps to configure HSM. The following topics are covered:

- [Create HSM Appliance](#)
- [Configure Set Key Handler](#)
- [Configure a GigaSMART Group](#)
- [Create a GigaSMART Operations \(GSOP\)](#)
- [Configure the Keys Residing on HSM](#)
- [Configure the GigaSMART Operation for Out-of-Band SSL Decryption](#)
- [Configure Maps](#)

Create HSM Appliance

Configure at least one HSM by specifying an alias, a static IP address, and port number. Obtain the ESN and KNETI from your HSM administrator.

To access GigaSMART within GigaVUE-FM, access a device that has been added to GigaVUE-FM from the GigaVUE-FM interface. **GigaSMART** appears in the navigation pane of the device view on supported devices. Refer to the [Access GigaSMART from GigaVUE-FM](#) for details.

To configure an HSM appliance, do the following:

1. From the device view, select **GigaSMART > Passive SSL > HSM**.
2. Click **Add**.

▼ HSM Appliances Info

Alias * hms1

IP Address * 10.11.176.5

Port Number * 9004

ESN * FBC5-F777-2A93

KNETI * 30eab672d888d22eab811755d5938981ca5c8f18

Key Handler * Install from URL Install from Local Directory

Path * <protocol>://<username>@<hostname/IP address>/<file p
This is field is required. The filename must be "module_<esn>" format. (module_FBC5-F777-2A93)
 e.g. scp://username@121.0.0.1/path/filename

Password Password

Figure 483: Creating New HSM

3. Click **Add**.
4. Type **hsm1** in the Alias field.
5. Enter valid **IP address**.
6. Enter Port number.
7. Type **ESN**
8. Type **KNET**
9. Select **Key Handler > Install from URL**.
10. Type the Path of the Key handler file.
11. Click **OK**.

Configure Set Key Handler

1. From the device view, select GigaSMART > **Passive SSL > HSM**.
2. Select the **HSM appliance** you just created.
3. Click **Configure**.

Key Handler of All Appliances * Install from URL Install from Local Directory

Path * ?

Filename must be "world"
e.g. scp://username@121.0.0.1/path/filename

Password

Figure 484: HSM-Configure Key Handler

4. Type the Path. Path filename must include world.
5. Click **OK**.

Configure Passive SSL Network Access

In this step you need to configure Passive SSL Network Access along with an valid IP address for GigaSMART.

1. From the device view, select GigaSMART > **Passive SSL** > **Network Access**.
2. Select the **GigaSMART appliance**.
3. Click **Edit**.

	DHCP	Status	IP Address	Netmask	Gateway	DNS Server	HW Address	MTU
GigaSMART								
3/1/e1	Disabled							

Figure 485: Passive SSL Network - Edit

4. Select **IP Address**
5. Click **OK**.

Uploading SSL Private Keys

To access GigaSMART within GigaVUE-FM, access a device that has been added to GigaVUE-FM from the GigaVUE-FM interface. **GigaSMART** appears in the navigation pane of the device view on supported devices. Refer to the [Access GigaSMART from GigaVUE-FM](#) for details.

Each GigaSMART card requires IP address configuration for network access. To configure IP address details, do the following:

1. Enter **IP Address, Network, Gateway, DNS, MTU and VLAN** parameters.

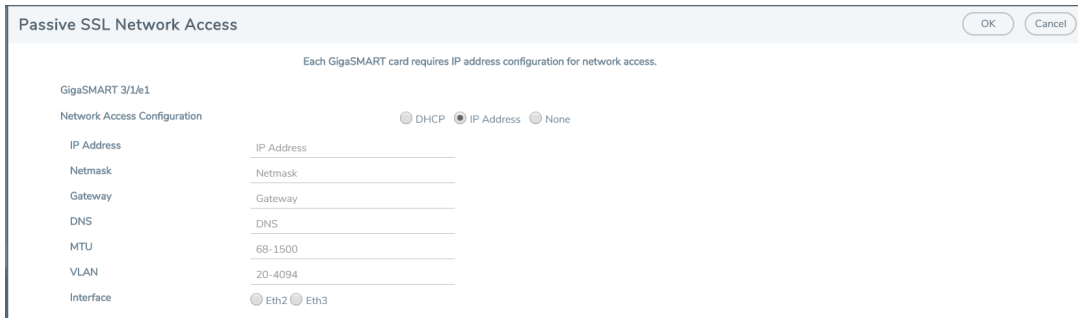


Figure 486: Passive SSL Network Access - IP Configuration

2. Click **OK**.

Configure a GigaSMART Group

1. From the device view, select GigaSMART > **Passive SSL** > **HSM**.
2. Click **New**.
3. Type **GS** in Alias field.



Figure 487: GigaSMART Group Setup Page

4. Select the **Port** you want to associate with this group.
5. Scroll down the page and click **Enable HSM**.

6. Click **OK**.

Create a GigaSMART Operations (GSOP)

To create a GigaSMART operation with an SSL Decryption component, do the following:

1. From the device view, select **GigaSMART > GigaSMART Operations (GSOP) > GigaSMART Operation**.
2. Click **New**.
3. In the Alias field, enter **hsm** for the GigaSMART Operation.
4. From the GigaSMART Groups list, select a **GigaSMART group**.
5. From the GigaSMART Operations (GSOP) list, **select SSL Decryption**.

The screenshot shows a configuration window titled "GigaSMART Operation (GSOP)". It contains the following fields and values:

- Alias: hsm
- GigaSMART Group: gs1
- GigaSMART Operations (GSOP): SSL Decryption
- SSL Decryption section (expanded):
 - In Port: any
 - Out Port: auto

Buttons for "OK" and "Cancel" are located in the top right corner of the window.

Figure 488: GigaSMART Operations - Setup Page

6. Click **OK**.

Configure the Keys Residing on HSM

Before uploading keys or configuring SSL, you must create an SSL keychain password. The password is used to encrypt the private keys that you upload to the node.

NOTE: When uploading SSL keys, make sure that you are not creating a duplicate key. Adding a duplicate key can cause errors.

To create an SSL keychain password, use the following steps:

1. From the device view, select **GigaSMART > Passive SSL > Key Store**.
2. Click **Keychain** Password.

Figure 489: SSL Keychain Password Setup Page

3. Enter a **password** in the Password and Confirm Password fields. You can only configure a strong password. A strong password has at least ten (10) characters and at least three (3) of the following:
 - uppercase letters
 - lowercase letters
 - numbers
 - special characters
4. Click **Submit**.

Uploading SSL Private Keys

To upload an SSL private key, do the following:

1. From the device view, select **GigaSMART** > Passive SSL > Key Store to open the Key Store page.
2. Click **Install**.
3. The SSL Key page displays.

Figure 490: SSL Key Page

4. Enter an **Alias** for the SSL key in the Alias field.
5. Select the **upload type**. Keys residing on the HSM, the type selected must be **PKCS #11**.
6. Choose the file. The URL can be downloaded using **HTTP, HTTPS, FTP, TFTP, SCP, and SFTP**. Using a secure protocol, such as **HTTPS** is recommended.
7. Click **Save**.

Configure the GigaSMART Operation for Out-of-Band SSL Decryption

After you have uploaded a private key, you can add a service. A service maps to a physical server, such as an HTTP server. One server can run multiple services. A service is a combination of an IP address and a server port number. Also, the key and the service must be tied together.

To create a service, do the following:

1. From the device view, select **GigaSMART > Passive SSL > SSL Services**.
2. Click **New**. The SSL service page appears.

Figure 491: SSL Service

3. On the SSL Service configuration page, do the following:

- Enter an **alias**.
- Enable **Default Service** to identify all IP addresses and server ports.
- Enter the information for the service: **IP Address, Server Port**.
- Select the alias of SSL Key previously uploaded for **SSL Key Alias**.
- Select the **GS Group** with SSL decryption enabled to associate with this SSL service.

4. Click **OK**.

Configure Maps

1. Select **Maps > Maps**.
2. Click **New**.
3. Configure the map.

Figure 492: Create New Map

- Type **map11** in the Alias field.
- Select Regular for **Type**.
- Select **By Rule** for **Subtype**.
- Select the network port for the Source.
- Select **Tool port/Hybrid port** for Destination.

▼ Map Source and Destination

Port Editor

Source

Destination

GigaSMART Operations (GSOP)

Figure 493: Configure Map Details

4. Add a **Rule**.

Destination

GigaSMART Operations (GSOP)

▼ Map Rules

Quick Editor Import Add a Rule

× Rule 1 Pass Drop Bi-directional

Rule Comment

▼ Map Order

Inner VLAN

Figure 494: Figure 20-123: Map Details - Create Rule

- Click **Add a Rule**.
 - Select **Pass**.
 - Select **IPv4 Version** and set **Version to v4**.
4. Click **Save**.

Tunneling Operations

GigaSMART tunneling operations:

GigaSMART IP Encapsulation/Decapsulation (GigaSMART Tunnel)

Required License for IP Decapsulation: Base (GigaVUE-HC2, and GigaVUE-HC3), Tunneling (GigaVUE-HC1 and GigaVUE-HB1)

Required License for IP Encapsulation: Advanced Tunneling (GigaVUE-HC2, and GigaVUE-HC3), Tunneling (GigaVUE-HC1 and GigaVUE-HB1)

Use GigaSMART encapsulation and decapsulation operations to send traffic arriving on one GigaSMART-enabled node over the Internet to a second GigaSMART-enabled node. There, the traffic is decapsulated and made available to local tool ports.

This feature is useful when instrumenting remote data centers – you can tunnel selected portions of the traffic from the remote GigaSMART-enabled node to tools in a central location. Traffic is encapsulated at the sending end of the tunnel and decapsulated at the receiving end.

IP fragmentation and reassembly are supported. Refer to [IP Fragmentation and Reassembly on L2GRE and GMIP Tunnels](#).

The source of the GigaSMART tunnel can be any of the following:

- **GigaSMART-Enabled GigaVUE H Series Node**
 - Standalone GigaVUE-HC3 node with SMT-HC3-C05 modules installed.
 - Standalone GigaVUE-HC2 node with GigaSMART-HC0 front and/or rear modules installed.
 - Standalone GigaVUE-HC1 nodes.
 - Any GigaVUE H Series node operating in a cluster with the previous node types.
- **GigaVUE-2404 G Series node with a GigaSMART-6X line card installed**
- **GigaVUE V Series node or a GigaVUE-VM**

NOTE: You can also create GigaSMART operations that allow a GigaVUE H Series node to act as the receiving end of an ERSPAN tunnel for data mirrored over the Internet from Cisco equipment. However, this feature requires the Advanced Tunneling license; refer to [GigaSMART ERSPAN Tunnel Decapsulation](#).

Configure Both Ends of GigaSMART Tunnel

Creating a GigaSMART tunnel requires configuration on both the sending and receiving ends:

Sending End of Tunnel	Receiving End of Tunnel
<p>The sending end of a GigaSMART tunnel can be either a GigaVUE-VM deployment or a GigaSMART-enabled GigaVUE H Series or G Series node.</p> <p>Sending Data from a GigaSMART-Enabled GigaVUE H Series Node</p> <ul style="list-style-type: none"> • Configure an IP interface with an IP address, subnet mask, default gateway, MTU setting and assign it to a GigaSMART group. • Create a GigaSMART operation with a tunnel-encap component. The encapsulation settings include the IP address and listening UDP port of the P interface that is associated with a network port on the destination GigaVUE H Series. • Bind the GigaSMART operation to one or more network ports as part of a map. The network ports must be mapped to the IP interface associated with a tool port. <p>Sending Data from GigaVUE-VM/GigaVUE-FM</p> <p>When you provision a vMap for a GigaVUE-VM node in GigaVUE-FM, in addition to selecting the virtual traffic to be forwarded, you also specify the destination to which traffic should be tunneled with the following settings:</p> <ul style="list-style-type: none"> • UDP IP – The IP address of the P interface that is associated with a network port on the receiving end of the tunnel. • UDP Source Port – The source port from which traffic will be sent to the receiving end of the GigaSMART tunnel. • UDP Destination Port – The listening UDP port at the destination end of the GigaSMART tunnel. <p>Sending Data from GigaVUE-2404/GigaSMART-6X</p> <ul style="list-style-type: none"> • Configure an IP interface with an IP address, subnet mask, default gateway, and MTU setting. Associate the IP interface with a tool port. • Create a GigaSMART operation with an encapsulation component. The encapsulation settings include the IP address and listening UDP port of the IP interface that is associated with network port on the destination GigaVUE G Series. • Bind the GigaSMART operation to one or more network ports as part of a map rule with at 	<ul style="list-style-type: none"> • Configure an IP interface with an IP address, subnet mask, and default gateway. The IP address must match the destination IP address specified at the sending end of the tunnel. • Create a GigaSMART operation with a decapsulation component. The decapsulation settings include the same listening UDP port you specified as the destination port at the sending end of the tunnel. • Bind the GigaSMART operation to the IP interface that is associated with a network port as part of a map that distributes arriving traffic to local tool ports for analysis with local tools.

Sending End of Tunnel	Receiving End of Tunnel
least one regular map rule criterion. The network ports must be mapped to the IP interface associated with a tool port.	

Keep in mind the following when configuring GigaSMART operations with encapsulation/decapsulation components:

Feature	Description
Viewing Statistics	Use the show tunneled-port commands to see statistics related to ongoing tunnel operations. Refer to View GigaSMART Statistics for more information.
Packet Order	Packer sequence is not preserved if the packets are reordered while traversing the Internet. The receiving GigaSMART delivers them in the same order received.
GMIP Header	The GMIP header is 46 bytes consisting of 14 Ethernet + 20 IP + 8 UDP + 4 tunnel version.
Tunnel Decap Type GMIP portdst	Use the GigaSMART Operations page to specify the UDP port on which the P interface that is associated with a network port on the receiving GigaVUE H Series is listening. Use this option when decapsulating traffic from a either GigaSMART-enabled node or a GigaVUE-VM deployment. The setting must match the configuration of the portdst configured on the sending end of the tunnel.
GigaSMART Engine Ports	GigaSMART operations with a tunnel component can only be assigned to GigaSMART groups consisting of a single GigaSMART engine port. Refer to Groups of GigaSMART Engine Ports for more information.

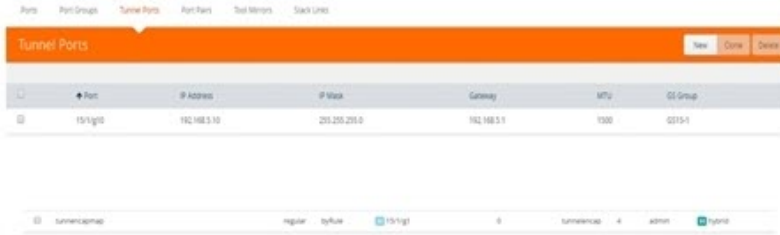
Example: GigaSMART Encapsulation/Decapsulation (GigaVUE-HB1 Node)

The following figures demonstrate how to create a sample IP tunnel between a sending GigaVUE-HB1 in Reno and a receiving GigaVUE H Series cluster in San Francisco. First, the overall tunnel is summarized, followed by configuration descriptions for the sending and receiving ends.

GigaVUE-HC1 in Reno

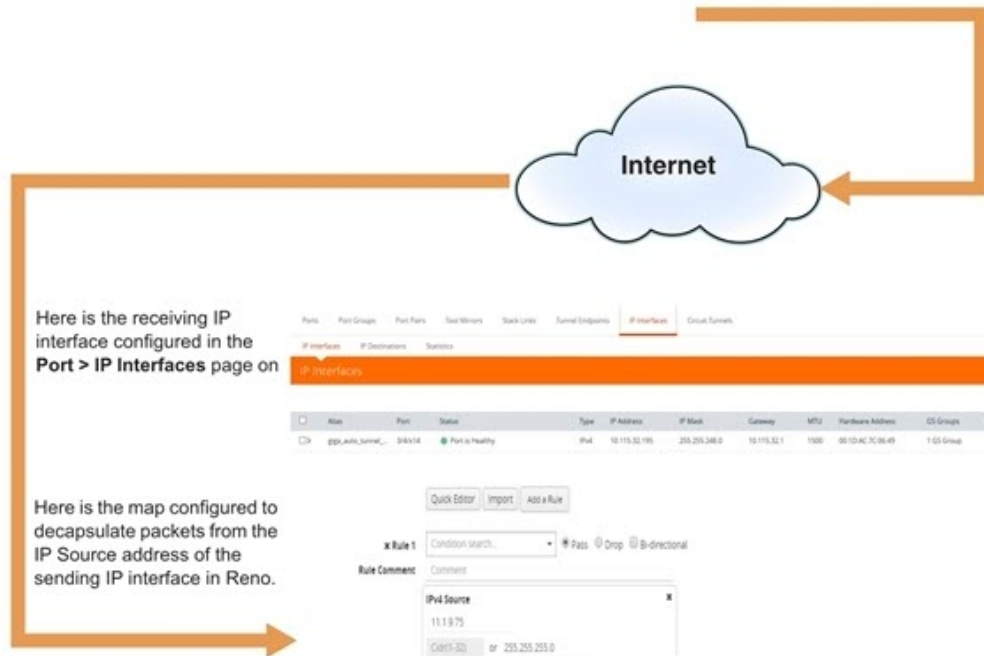


The GigaVUE-HC1 in Reno takes IPv4 packets arriving at network port 15/1/g1, encapsulates them in UDP packets, and forwards them across the Internet from IP interface 1/1/g10 to the receiving GigaVUE-HC2 in San Francisco.



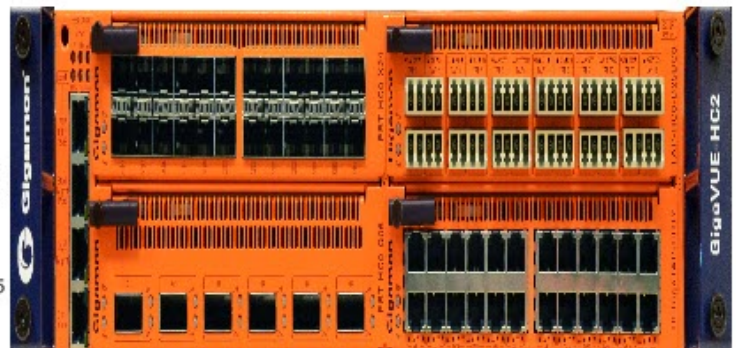
Set up the IP interface in the **Port > IP Interfaces** page. For example, 1/1/x9.

The **tunnelencap** GigaSMART operation bound as part of a map on network port 15/1/g1 specifies the destination IP address and UDP port (the address of the IP interface in San Francisco). Note that this map sends IPv4 packets to the 15/1/g1 IP interface configured in the **Port > IP Interfaces** page.



GigaVUE-HC2 with GigaSMART in San Francisco

IP interface 5/1/g2 in San Francisco decapsulates traffic arriving from Reno and makes it available for standard GigaVUE packet distribution to local tool ports. The **decapper1** GigaSMART operation bound to IP interface with network port 5/1/g2 with a map rule specifies the listening UDP port matching the one configured in Reno. It is sending traffic from IP address 11.1.9.75 to local tool port 1/1/g5 (a port on another node in the cluster).



Configure Sending End of Tunnel: GigaVUE-HB1 in Reno

The GigaVUE-HB1 in this location has an IP interface configured on tool port 1/1/g1 with an IP address of 11.1.9.75. Maps to this port that use a tunnel encapsulation GigaSMART operation can send data over the Internet. The following table summarizes the commands necessary to configure the sending end of the tunnel in the CLI:

Task	UI Steps
<p>Start by designating port 1/1/g1 as a tool port.</p>	<ol style="list-style-type: none"> 1. Select Ports > Ports > All Ports. 2. Click Quick Port Editor. 3. In the Quick View Editor find port 1/1/g1. 4. Set Type to Tool. 5. Select Enable 6. Click OK. 7. Close the Quick Port Editor.
<p>Use the IP Interfaces page to set up the network parameters for 1/1/g1. This page sets the IP address, subnet mask, default gateway, and MTU for the IP interface associated with a tool port on port 1/1/g1. Notice that the GigaSMART group in this example has the alias gsport1.</p>	<ol style="list-style-type: none"> 1. Select Ports > IP Interfaces. 2. Click New. 3. Configure the IP interface: <ul style="list-style-type: none"> • Alias: 1_1_g1 • Port: 1/1/g1 • IP Address: 11.1.9.75 • IP Mask: 255.255.255.0 • Gateway: 11.1.9.1 • MTU: 9400 • GigaSMART Group: gsport1 4. Click OK.
<p>Now, create a tunnel encapsulation GigaSMART operation (tunnelencap) that will send traffic to IP address 21.2.9.75 on destination UDP port 10000 from source port 5000. The operation has the alias tunnelenc.</p>	<ol style="list-style-type: none"> 1. From the device view, select GigaSMART > GigaSMART Operations (GSOP) > GigaSMART Operation. 2. Click New. 3. Configure the GigaSMART Operation: <ul style="list-style-type: none"> • Alias: tunnelenc • GigaSMART Groups: gsport1 • GigaSMART Operations (GSOP): Tunnel Encapsulation 4. Configure Tunnel Encapsulation: <ul style="list-style-type: none"> • GMIP

Task	UI Steps
	<ul style="list-style-type: none"> • Destination: IPv6 • Port Source: 5000 • Port Destination: 10000 • Destination IP: 21.2.9.75 • DSCP: 0 • Precision: 1 • TTL: 1 <p>5. Click Save.</p>
<p>Once you have the tunnel encapsulation operation, you can include it as part of a map rule. This map rule matches IPv4 packets and sends them to 21.2.9.75:10000 (the socket specified by the GigaSMART operation named tunnelencap that you created in the previous step).</p>	<ol style="list-style-type: none"> 1. Select Maps > Maps > Maps 2. Click New. 3. Configure the map. <ul style="list-style-type: none"> • Alias: tunnelencap • Type: Regular • Subtype: By Rule • Source: 1/1/x3 • Destination; 1/1/g1 • GigaSMART Operations (GSOP): tunnelencap (gsport1) 4. Click Add Rule. 5. Select Pass. 6. Select IP Version for Rule 1. 7. Select v4 or v6 for Version. 8. Save.

Configure Receiving End of Tunnel: GigaVUE-HD4 with GigaSMART in San Francisco

Now we need to configure the receiving end of the tunnel with an IP interface associated with network port. The GigaVUE-HD4 in this location will have an IP interface associated with network port configured on network port 5/1/g2 with an IP address of 21.2.9.75 and a GigaSMART decapsulation operation that listens on UDP port 10000.

The following table summarizes the steps necessary to configure the receiving end of the tunnel using the UI:

Task	UI Steps
Start by designating port 5/1/g2 as a network port.	<ol style="list-style-type: none"> 1. Select Ports > Ports > All Ports. 2. Click Quick Port Editor. 3. In the Quick View Editor find port 5/1/g2. 4. Set Type to Network. 5. Select Enable 6. OK. 7. Close the Quick Port Editor.
Use the IP Interfaces page to set up the network parameters for 5/1/g2. This command sets the IP address, subnet mask, default gateway, and MTU for the IP interface associated with network port on port 5/1/g2. Note that this port uses the same IP address to which the GSOP in Reno is configured to send data (21.2.9.75).	<ol style="list-style-type: none"> 1. Select Ports > IP Interfaces. 2. Click New. 3. Configure the IP Interface: <ul style="list-style-type: none"> • Alias: 1_1_g2 • Port: 1/1/g2 • IP Address: 21.2.9.75 • IP Mask: 255.255.255.0 • Gateway: 21.2.9.1 • MTU: 9400 • GigaSMART Group: gsport5 4. Save.
Now, create a tunnel decapsulation GigaSMART operation (tunnel-decap) that will decapsulate traffic received on UDP port 10000. Recall that we configured the sending end of the tunnel to send to that UDP port. The operation has the alias hd-decap1 .	<ol style="list-style-type: none"> 1. From the device view, select GigaSMART > GigaSMART Operations (GSOP). 2. Click New. 3. Configure the GigaSMART Operation: <ul style="list-style-type: none"> • Alias: hd-decap1 • GigaSMART Groups: gsport5 • GigaSMART Operations (GSOP): Tunnel Decapsulation 4. Configure the Tunnel Decapsulation. <ul style="list-style-type: none"> • GMIP • GMIP Port: 10000 5. Save.
Once you have your tunnel decapsulation operation, you can include it as part of a map rule. This map decapsulates all traffic arriving at 5/1/g2 from IP address 21.2.9.25 (the start of the tunnel) and sends it to port 1/1/g5. This is a tool port on the	<ol style="list-style-type: none"> 1. Select Maps > Maps > Maps 2. Click New. 3. Configure the map. <ul style="list-style-type: none"> • Alias: decapper

Task	UI Steps
chassis with box ID 1 in this cluster.	<ul style="list-style-type: none"> • Type: Regular • Subtype: By Rule • Source: 5/1/g2 • Destination: 1/1/g5 • GigaSMART Operations (GSOP): hd-decap1 (gsport5) <ol style="list-style-type: none"> 4. Click Add Rule. 5. Select Pass. 6. Select IPv4 Source for Rule 1. 7. Set the IPv4 Address to 11.1.9.75 8. Set the Net Mask to 255.255.255.0 9. Save.

Display GMIP Tunnel Decapsulation Statistics

To display tunnel decapsulation statistics, select **GigaSMART > GigaSMART Operations > Statistics** and click a on the GS Operation in the table to open the Quick View for GS Operations Statistics.

Refer to [Tunnel Decapsulation Statistics Definitions](#) and [GigaSMART Operations Statistics Definitions](#) for descriptions of these statistics.

Display GMIP Tunnel Encapsulation Statistics

To display tunnel encapsulation statistics, select **GigaSMART > GigaSMART Operations (GSOP) > Statistics** and click on the GS Operation in the table to open the Quick View for GS Operations Statistics.

Refer to [Tunnel Encapsulation Statistics Definitions](#) and [GigaSMART Operations Statistics Definitions](#) for descriptions of these statistics.

Example: GigaSMART Encapsulation/Decapsulation (GigaVUE-VM)

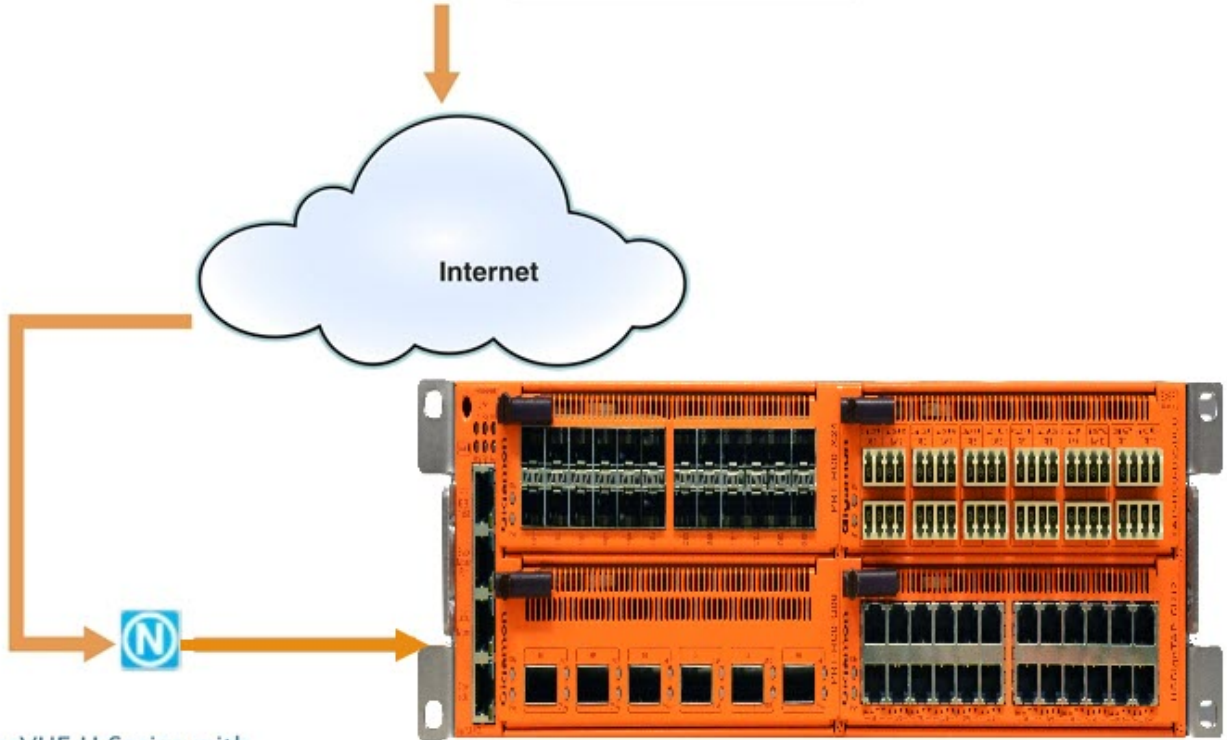
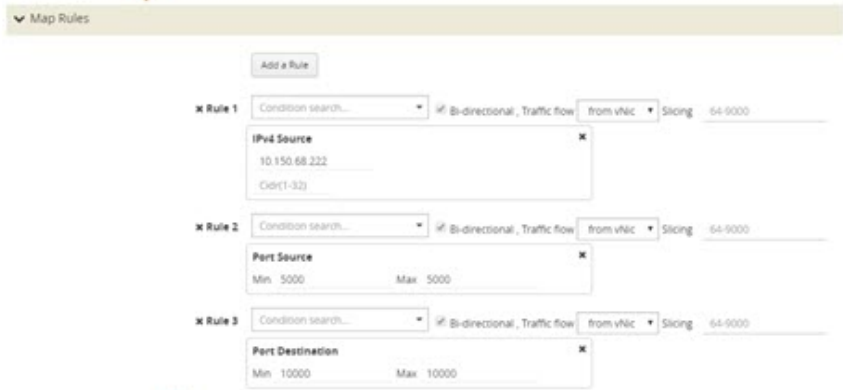
The following figures demonstrate how to create a sample IP tunnel between a sending GigaVUE-VM node in Sydney and a receiving GigaVUE H Series in Melbourne. First, the overall tunnel is summarized, followed by configuration descriptions for the sending and receiving ends.

GigaVUE-VM vMap in Sydney



The GigaVUE-VM vMap in Sydney takes virtual packets matching the criteria specified by the vMap, encapsulates them in UDP packets, and forwards them across the Internet to the receiving GigaVUE H Series in Melbourne.

The vMap includes the destination IP address and UDP port (the address of the IP interface associated with network port in Melbourne, shown in highlighting).



GigaVUE H Series with GigaSMART in Melbourne

IP interface associated with network port 1/1/x3 in Melbourne decapsulates traffic arriving from Sydney and makes it available for standard GigaVUE packet distribution to local tool ports. The decapsulation operation bound to IP interface associated with network port 3 as part of a map specifies the listening UDP port matching the one configured in Sydney.

The GigaSMART decapsulation operation is based on the GigaVUE-HC2 line card in slot 3.

Configure Sending End of Tunnel: GigaVUE-VM vMap in Sydney

A GigaVUE-VM node in this location is configured with a vMap that will send data over the Internet to the IP interface associated with a network port on a GigaVUE H Series with a GigaSMART-HD0 line card installed.

VMaps are created in the GigaVUE-FM user interface – Step 2 in the Create Map wizard includes **Tunnel Traffic To** settings that specify where matching traffic should be sent:

Create vMap “Tunnel Traffic To” Option	Setting
UDP IP	This is the destination IP address for the IP interface associated with network port on the GigaVUE H Series in Melbourne. We will set it to 10.150.68.222
UDP Source Port	This is the UDP source port from which tunneled packets will be sent. We will set this to 5000.
UDP Destination Port	This is the listening port on the receiving GigaVUE H Series IP interface associated with network port. We will set this to 10000.

Configure Receiving End of Tunnel: GigaVUE H Series with GigaSMART in Melbourne

Now we need to configure the receiving end of the tunnel with an IP interface associated with network port. The GigaVUE H Series in this location will have an IP interface associated with network port configured on network port 1/1/3 with an IP address of 10.150.68.222 and a GigaSMART decapsulation operation that listens on UDP port 10000.

The following table summarizes the steps necessary to configure the receiving end of the tunnel using the UI:

Task	UI Steps
Start by designating port 1/1/x3 as an IP interface with network port, configuring its IP profile, and assigning its GigaSMART operations to a GigaSMART group. This command sets the IP address, subnet mask, default gateway, and MTU for the IP interface associated with a tool port on port 1/1/x3.	<ol style="list-style-type: none"> 1. Select Ports > IP Interfaces. 2. Click New. 3. Configure the IP Interface: <ul style="list-style-type: none"> • Alias: 1_1_x3 • Port: 1/1/x3 • IP Address: 10.150.68.222 • IP Mask: 255.255.255.255 • Gateway: 10.150.68.1 • MTU: 9400

Task	UI Steps
<p>Now, create an IP decapsulation GigaSMART operation (gmipdecap) that will decapsulate traffic received on UDP port 10000. Recall that we configured the sending end of the tunnel to send to that UDP port. The operation has the alias gv_ipdecap.</p> <p>Note that this operation uses the same GigaSMART group (GS2) as the IP interface associated with network port we set up in the first step.</p>	<ul style="list-style-type: none"> • GigaSMART Group: GS2 <ol style="list-style-type: none"> 4. Save <hr/> <ol style="list-style-type: none"> 1. From the device view, select GigaSMART > GigaSMART Operations > GigaSMART Operation. 2. Click New. 3. Configure the GigaSMART Operation: <ul style="list-style-type: none"> • Alias: gv_ipdecap • GigaSMART Groups: GS2 • GigaSMART Operations (GSOP): Tunnel Decapsulation 4. Configure the Tunnel Encapsulation: <ul style="list-style-type: none"> • GMIP • GMIP Port: 10000 5. Save.
<p>Once we have our IP decapsulation operation, we can include it as part of a map.</p> <ul style="list-style-type: none"> • Open the map configuration page to create a map named decapper. • The Source field specifies the ingress ports for this map. • The GSOP field applies the gv_ipdecap GigaSMART operation to all packets matching the rules in the map, decapsulating them from the tunnel. • The Destination field specifies where matching packets will be sent (tool port 1/1/x11). • The rule with Pass selected specifies that packets arriving on this port with an IP Source address of 10.10.10.10 /32 will be processed by the gv_ipdecap GSOP and sent to tool port 1/1/x11. 	<ol style="list-style-type: none"> 1. Select Maps > Maps > Maps 2. Click New. 3. Configure the map. <ul style="list-style-type: none"> • Alias: decapper • Type: Regular • Subtype: By Rule • Source: 1/1/x3 • Destination: 1/1/x11 • GigaSMART Operation (GSOP): gv_ipdecap (GS2) 4. Click Add Rule. <ul style="list-style-type: none"> • Select Pass. • Select IPv4 Source for Rule 1. • Set the IPv4 Address to 10.10.10.10 • Set the Net Mask to 255.255.255.255 5. Click Save.

GigaSMART IP Encapsulation (GigaSMART Tunnel)

Required License for IP Encapsulation: Advanced Tunneling (GigaVUE-HC2, and GigaVUE-HC3), Tunneling (GigaVUE-HC1)

GigaSMART-enabled nodes with the Advanced Tunneling license installed can encapsulate traffic and send it through a GigaSMART tunnel to a destination GigaSMART-enabled node.

1. Configure an IP interface with an IP address, subnet mask, default gateway, and MTU setting and assign it to a GigaSMART group.
2. Create a GigaSMART operation with a **Tunnel Encapsulation** component. The encapsulation settings include the IP address and listening UDP port of the IP interface associated with network port on the destination GigaVUE H Series.
3. Bind the GigaSMART operation to one or more network ports as part of a map. The network ports must be mapped to the IP interface associated with a tool port.

Refer to the sections beginning with [Configure Both Ends of GigaSMART Tunnel](#) for examples of the end-to-end configuration of a GigaSMART tunnel.

GigaSMART Layer 2 GRE Tunnel Encapsulation/Decapsulation

Required License for L2GRE Decapsulation: Base (GigaVUE-HC2, and GigaVUE-HC3), Tunneling (GigaVUE-HC1)

Required License for L2GRE Encapsulation: Advanced Tunneling (GigaVUE-HC2, and GigaVUE-HC3), Tunneling (GigaVUE-HC1)

Use GigaSMART Layer 2 (L2) Generic Routing Encapsulation (GRE) tunnel encapsulation to send traffic from one GigaSMART node over the Internet to a second GigaSMART node using L2GRE encapsulation. Use GigaSMART L2GRE tunnel decapsulation at the second GigaSMART node to decapsulate the traffic before sending it to local tool ports.

GigaSMART Layer 2 GRE tunnel encapsulation/decapsulation provides the following:

- L2GRE tunnel initiation and encapsulation on the tool port at the sending end of the tunnel (for example, at a remote site)
- L2GRE tunnel termination and decapsulation on the network port at the receiving end of the tunnel (for example, at a main office site)

The GigaSMART at the remote site encapsulates the filtered packets, adds an encapsulation header, and routes it to the main office site. The encapsulation protocol is GRE and the delivery protocol is IP or IPv6, so the encapsulation header consists of Ethernet + IP + GRE or Ethernet + IPv6 + GRE headers.

The parameters of the encapsulated header are user-configurable, such as the IPv4 address of the IP interface on the destination GigaSMART node and the GRE key that identifies the source of the tunnel.

At the remote end, packets are decapsulated, the L2GRE header is stripped off, and packets are sent to the specified tool port.

IP fragmentation and reassembly are supported. Refer to [IP Fragmentation and Reassembly on L2GRE and GMIP Tunnels](#).

[Figure 495: L2GRE Tunnel Encapsulation/Decapsulation](#) shows the remote site encapsulating the filtered traffic and routing it to the main office from the remote end.

The encapsulated packet is sent out of the tool port, which is connected to the public network (the Internet). This packet is routed in the public network to reach the main office site. It ingresses at the routed network port of the GigaVUE node at the main office.

The ingress encapsulated packet is then sent to the GigaSMART at the main office, where the packet is decapsulated and sent to the tool port. The received packet's destination IP is checked against the source IP/IPv6 configured for the network port. If they match, decapsulation is applied. The Ethernet + IP + GRE or Ethernet + IPv6 + GRE header is stripped and the remaining packet is sent to the tool port.

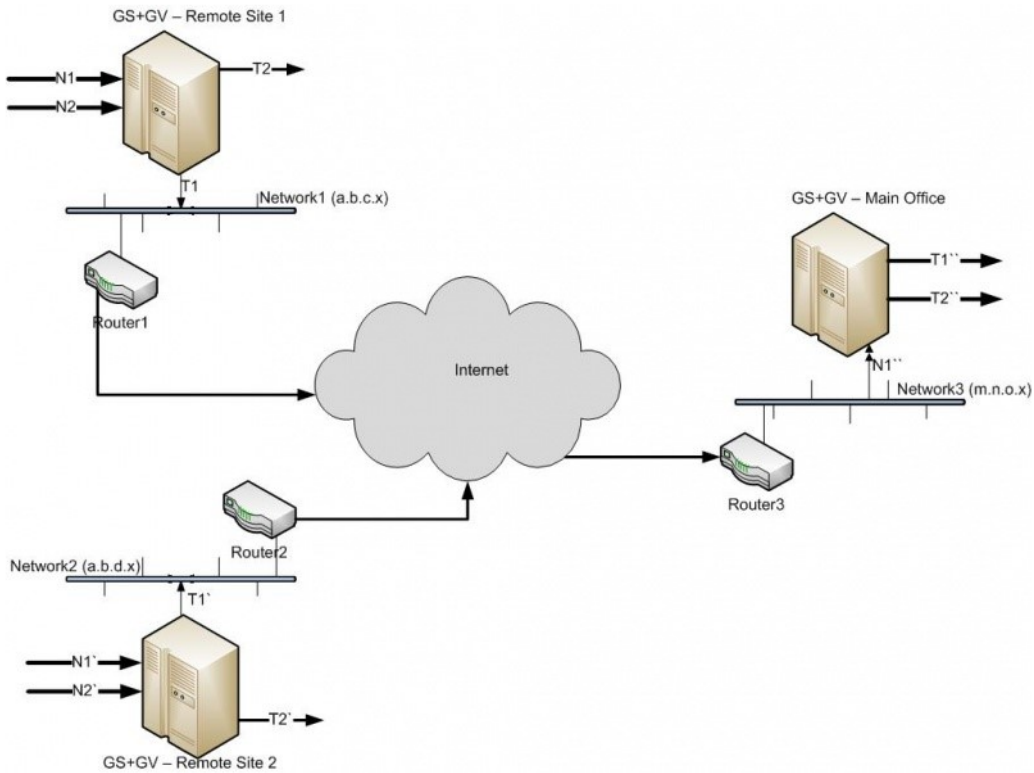


Figure 495: L2GRE Tunnel Encapsulation/Decapsulation

For L2GRE tunnel encapsulation/decapsulation configuration examples, refer to [Example 1 – GigaSMART L2GRE Tunnel Encapsulation](#) and [Example 4 – GigaSMART L2GRE Tunnel Decapsulation](#).

For statistics for encapsulated packets, refer to [Display L2GRE Tunnel Encapsulation Statistics](#). For statistics for decapsulated packets, refer to [Display L2GRE Tunnel Decapsulation Statistics](#).

Layer 2 GRE Header Length

The L2GRE header length is as follows:

Header	Length in Bytes
With Key	42 bytes consisting of 14 Ethernet + 20 IP + 4 GRE + 4 GRE Key.
Without Key	38 bytes consisting of 14 Ethernet + 20 IP + 4 GRE.

Load Balancing to Multiple Destinations

Starting in software version 5.1, L2GRE tunnel encapsulation supports load balancing. Traffic from an IP Interface can be sent to multiple destinations Defined by IP address. The traffic is distributed using stateful load balancing or stateless hashing.

For information on stateful and stateless load balancing, refer to [GigaSMART Load Balancing](#).

For examples of load balancing on L2GRE encapsulation, refer to [Example 2 – GigaSMART L2GRE Tunnel Encap Stateful LB](#) and [Example 3 – GigaSMART L2GRE Tunnel Encap Stateless LB](#).

L2GRE IPv6 Encapsulation/Decapsulation

Gigasmart L2GRE IPv6 lets you route filtered traffic to the remote end using IPv6-based L2GRE tunneling. At the receiving end, filtered traffic is sent to GigaSMART, which adds an L2GRE header and a IPv6 header to make it routable. The remote end decapsulates the packet and sends it to the tool port.

GigaVUE nodes act as L2GRE encapsulation and decapsulation devices.

The IPv6 protocol is used to deliver all packets received in the encap tunnel to the termination node using the configured source and destination IPv6 address. The tunnel termination (decap) node strips the IPv6 + GRE header and sends the payload to the tool port.

The ICMPv6 protocol is used by the tool port on the encapsulation node for Neighbor Solicitation (NS) and Neighbor Advertisement (NA) messages to resolve the gateway MAC address and respond to NS messages received from the gateway in the tunnel decapsulation/termination node. ICMPv6 echo request/reply messages are also sent and received.

For a configuration example, refer to [Example 5 – GigaSMART L2GRE IPv6 Tunnel Encap/Decap with Load-Balancing](#)

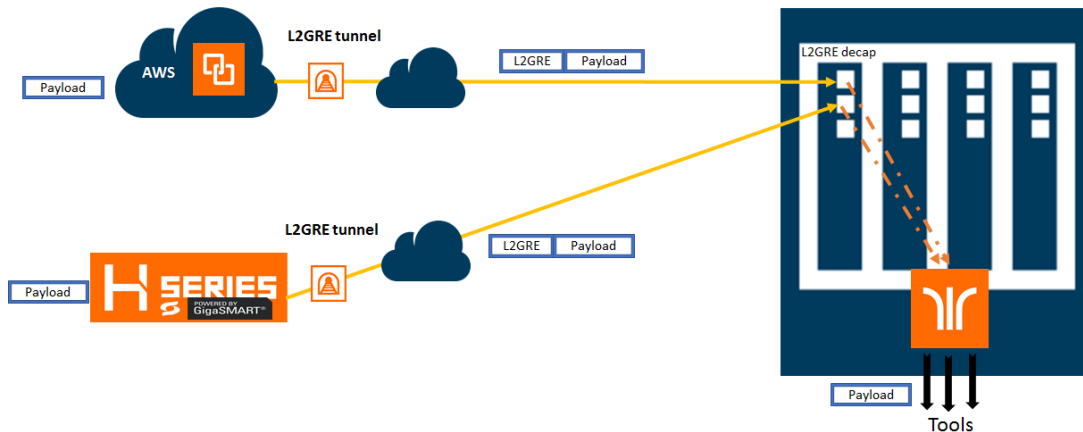
L2GRE Tunnel Termination

L2GRE tunnel termination is supported on physical devices, and the decapsulation happens through the GigaSMART engine. Tunneled traffic coming in the chassis is sent to the GigaSMART engine, which is sent to the tools using a hybrid port. The maps created are then applied to this decapsulated traffic.

Starting with version 5.4, tunnel termination is supported for VXLAN and L2GRE tunnel in the front panel ports of the switch. This feature provides line rate tunneling on all faceplate ports and also allows flow mapping to be applied for the incoming tunneled traffic on the same ports.

The following diagram illustrates how the traffic from two sources—a GigaVUE V Series appliance running on an AWS platform and a GigaVUE H Series device at a remote site traverses through the L2GRE tunnel and reaches the GigaVUE-H Series node in the main office site. In each case, traffic is tapped at the remote source and is then tunneled through L2GRE encapsulation across the cloud

before it reaches the GigaVUE H Series device at the main office site, which is connected to the actual tools. The L2GRE tunnel termination is executed on an ingress circuit port (IP interface) on the destination GigaVUE H Series device. After tunnel termination, the packet is presented to the flow mapping module to filter based on map rule parameters.



Configure L2GRE Tunnel Encapsulation and Decapsulation

Refer to the following configuration examples:

- [Example 1 – GigaSMART L2GRE Tunnel Encapsulation](#)
- [Example 2 – GigaSMART L2GRE Tunnel Encap Stateful LB](#)
- [Example 3 – GigaSMART L2GRE Tunnel Encap Stateless LB](#)
- [Example 4 – GigaSMART L2GRE Tunnel Decapsulation](#)
- [Example 5 – GigaSMART L2GRE IPv6 Tunnel Encap/Decap with Load-Balancing](#)

Configure GigaSMART Operation for Layer 2 GRE

To access GigaSMART within GigaVUE-FM, access a device that has been added to GigaVUE-FM from the GigaVUE-FM interface. GigaSMART appears in the navigation pane of the device view on supported devices. Refer to [Access GigaSMART from GigaVUE-FM](#) for details.

To configure the L2GRE encapsulation/decapsulation types and options, use the GigaSMART Operations (GSOP) page:

1. From the device view, select **GigaSMART > GigaSMART Operations (GSOP) > GigaSMART Operation**.
2. Click **New**.
3. On the GigaSMART Operations page, do the following:

- a. Type an alias in the **Alias** field.
 - b. In the **GigaSMART Groups** field, select the gsgroup for this operation.
 - c. In the **GigaSMART Operations (GSOP)** field, select either **Tunnel Decapsulation** or **Tunnel Encapsulation** from the drop-down list, depending on whether you want decapsulation or encapsulation.
 - d. Select **L2GRE**, and then enter options in the fields that display.
4. Click **Save**.

Example 1 – GigaSMART L2GRE Tunnel Encapsulation

In this example, an IP interface is configured on the tool port. A GigaSMART operation for tunnel encapsulation is configured to encapsulate the filtered packets. A map is configured that uses the L2GRE tunnel encapsulation GigaSMART operation, which sends packets from the remote site over the Internet to the main office using the IP interface associated with a tool port. Starting with software version 5.4 GigaSMART L2GRE Tunnel Encapsulation provides support for IPv6 with load-balancing.

Task	Description	UI Steps
1.	Configure a tool type of port and a network type of port.	<ol style="list-style-type: none"> a. Select Ports > All Ports. b. Click Quick Port Editor. c. Use Quick search to find the ports to configure. d. Set the type (Network or Tool) for each port and select Enable.
2.	Configure a GigaSMART group and associate it with a GigaSMART engine port.	<ol style="list-style-type: none"> a. From the device view, select GigaSMART > GigaSMART Groups. b. Click New. c. Type an alias in the Alias field and enter an engine port in the Port List field. d. Save.
3.	Configure the IP interface with an IP address, subnet mask, default gateway, and MTU setting. Assign it to the GigaSMART group.	<ol style="list-style-type: none"> a. Select Ports > Ports > IP Interfaces. b. Click New. c. On the IP Interfaces page, in the Alias and Comment fields, enter a name and description for the IP interface. d. Click the Ports field and select the network or tool port from the drop-down list. e. Select Type: IPv4 or IPv6 f. Enter the IP address, subnet mask, gateway, and MTU settings in the respective fields. g. Click on the GigaSMART Group field to select the GigaSMART group.

Task	Description	UI Steps
4.	Configure the GigaSMART operation for tunnel encapsulation and assign it to the GigaSMART group. The tunnel encapsulation settings include the IP address (IPv4) of the IP interface on the destination GigaSMART node and the GRE key that identifies the source of the tunnel.	<ul style="list-style-type: none"> h. Save. <ul style="list-style-type: none"> a. From the device view, select GigaSMART > GigaSMART Operations > GigaSMART Operation. b. Click New. c. Type an alias in the Alias field. d. From the GigaSMART Groups drop-down list, select the GigaSMART Group that you created in the second task. e. From the GigaSMART Operations (GSOP) drop-down list select Tunnel Encapsulation. f. Select L2GRE for the encapsulation type. g. Enter the IP address of the IP interface in the Destination IP field. h. IPv4, IPv6 or Port Group i. Enter the key parameter in the Key field. j. Save.
5.	Create a map using the tunnel encapsulation GigaSMART operation, with packets coming from the network port and being sent to the Internet through the tool port.	<ul style="list-style-type: none"> a. Select Maps > Maps. b. Click New. c. Type an alias in the Map Alias field that will help you identify this map. d. Select Regular for Type and By Rule for Subtype. e. Specify the network and tool ports that you configured in task one in the Source and Destination fields, respectively. f. From the GigaSMART Operations (GSOP) drop-down list, select the GigaSMART operation configured in task 4. g. Click Add a Rule under Map Rules and create the following rule: Select IP Version from the drop-down list and select v4 for Version, and then select Pass. h. Click Save.

Example 2 – GigaSMART L2GRE Tunnel Encap Stateful LB

Example 2 configures stateful load balancing of tunnel traffic to tunnel endpoints based on a metric. Each tunnel endpoint is assigned a weight.

To access GigaSMART within GigaVUE-FM, access a device that has been added to GigaVUE-FM from the GigaVUE-FM interface. GigaSMART appears in the navigation pane of the device view on supported devices. Refer to [Access GigaSMART from GigaVUE-FM](#) for details.

To configure this example:

1. Go to **Ports > Ports > All Ports**. Make sure you have one tool type of port and one network type of port enabled. Also make sure you have a GigaSMART port (eport).
2. Go to **GigaSMART > GigaSMART Groups**.
3. Click **New**, and then configure an Alias for the GigaSMART group and associate it with a GigaSMART engine port.
4. Click **OK**.
5. Go to **Ports > Ports > IP Interfaces**.
6. Click **New**, and then in the Alias and Comment fields, enter the alias and description of the IP interface.
7. Select a port and configure it with an IP version Type, IP Address, IP Mask, Gateway, and MTU. Assign the IP interface to the GigaSMART group.
8. Click **OK**.
9. Go to **Ports > Tunnel Endpoints**.
10. Click **New**, then configure one or more tunnel endpoint IDs and their IP Addresses. The Alias is optional.
11. Click **OK**.
12. Go to **Ports > Port Groups**.
13. Click **New**, then type an alias for the port group, select GigaSMART Load Balancing, select the previously configured tunnel endpoints. Optionally, you can specify weights for each tunnel endpoint in the port group.
14. Click **OK**.
15. Go to **GigaSMART > GigaSMART Operations (GSOP) > GigaSMART Operation**.
16. Click **New**, then select the same GigaSMART Group and Tunnel Encapsulation for the GSOP. Under Load Balancing, select Stateful, the type Tunnel, and the metric, such as Round Robin. Under Tunnel Encapsulation, select L2GRE, Destination Port Group, select the Port Group, Session Field, and Session Position. Refer to [Figure 496: New GigaSMART Operation for Stateful Load Balancing](#).

Alias

GigaSMART Group

GigaSMART Operations (GSOP)

Load Balancing ✕

Stateful

Type

Select a Metric ...

Tunnel Encapsulation ✕

L2GRE

Destination IPv4 IPv6 Port Group

Port Group

Key

Session Field

Session Position Inner Outer

Figure 496: New GigaSMART Operation for Stateful Load Balancing

17. Click **OK**.

18. Go to **Maps > Maps**.

19. Click **New**, then type an alias for the map, select type Regular and subtype ByRule. Under Map Source and Destination, select a network port as the Source and a tool port as the Destination, then select the GigaSMART operation. Under Map Rules, configure a map rule. Refer to [Figure 497: New Map Configuration](#).

Map Info

Map Alias

Comments

Type

Subtype

No Rule Matching Pass Traffic

Map Source and Destination

Port Editor

Source

Destination

GigaSMART Operations (GSOP)

Map Rules

Quick Editor Import Add a Rule

✕ Rule 1 Pass Drop Bi-directional

Rule Comment

Protocol

Figure 497: New Map Configuration

20. Click **OK**.

Example 3 – GigaSMART L2GRE Tunnel Encap Stateless LB

Example 3 configures stateless load balancing of tunnel traffic to tunnel endpoints based on a hash value.

Example 3 has the same configuration steps as Example 2 except for the GigaSMART operation (gsop) in [Step 16](#). Under Load Balancing, select Stateless and the metric, such as Five Tuple. Under Tunnel Encapsulation, select L2GRE, Destination Port Group, and select the Port Group. Refer to [Figure 498: New GigaSMART Operation for Stateless](#).

The screenshot shows a configuration interface for a GigaSMART operation. At the top, the 'Alias' is set to 'new1'. Below it, the 'GigaSMART Group' is set to 'GS2'. The 'GigaSMART Operations (GSOP)' dropdown is empty. The 'Load Balancing' section is expanded, showing 'Stateless' selected in the dropdown, 'Five Tuple' as the metric, and 'Outer' selected as the session position. The 'Tunnel Encapsulation' section is also expanded, showing 'L2GRE' selected. Under 'Destination', 'Port Group' is selected with radio buttons. The 'Port Group' dropdown is set to 'Select...'. The 'Key' is '0 ~ 4294967295'. The 'Session Field' dropdown is empty. The 'Session Position' is set to 'Outer'. A note at the bottom states: 'Note: For Stateless Load Balancing, Session Field and Session Position are not applicable'.

Figure 498: New GigaSMART Operation for Stateless

Example 4 – GigaSMART L2GRE Tunnel Decapsulation

In this example, an IP interface is configured on the network port. A GigaSMART operation for tunnel decapsulation is configured to decapsulate the filtered packets. A map is configured that uses the L2GRE tunnel decapsulation GigaSMART operation, which receives packets from the remote site over

the Internet to the main office using the IP interface associated with a tool port and then forwards packets over the tool port. Starting with software version 5.4 GigaSMART L2GRE Tunnel Decapsulation provides support for IPv6 with load-balancing.

Task	Description	UI Steps
1.	Configure a network type of port and a tool type of port.	<ol style="list-style-type: none"> a. Select Ports > Ports > All Ports. b. Click Quick Port Editor. c. Use Quick search to find the ports to configure. d. Set the type for each port and select Enable.
2.	Configure a GigaSMART group and associate it with a GigaSMART engine port.	<ol style="list-style-type: none"> a. From the device view, select GigaSMART > GigaSMART Groups. b. Click New. c. Type an alias in the Alias field and enter an engine port in the Port List field. d. Click Save.
3.	Configure the IP interface with an IP address, subnet mask, default gateway, and MTU setting. Assign it to the GigaSMART group. The IP address must match the destination IP address specified at the sending end of the tunnel.	<ol style="list-style-type: none"> a. Select Ports > IP Interfaces. b. Click New. c. On the IP Interfaces page, in the Alias and Comment fields, enter the name and description for the IP interface. d. Click the Ports field and select the port from the drop-down list. e. Enter the IP address, subnet mask, gateway, and MTU settings in the respective fields. f. Click on the GigaSMART Group field to select the GigaSMART group. g. Click Save.
4.	Configure the GigaSMART operation for tunnel decapsulation and assign it to the GigaSMART group. The tunnel decapsulation settings include the GRE key that identifies the source of the tunnel.	<ol style="list-style-type: none"> a. From the device view, select GigaSMART > GigaSMART Operations > GigaSMART Operation. b. Click New. c. Type an alias in the Alias field. d. From the GigaSMART Groups drop-down list, select the GigaSMART Group that you created in the second task. e. From the GigaSMART Operations (GSOP) drop-down list select Tunnel Decapsulation. f. Select L2GRE for the decapsulation type. g. Enter the GRE key in the Key field. h. Click Save.
5.	Create a map using the tunnel decapsulation GigaSMART operation, with packets coming from the Internet through the network port and being sent	<ol style="list-style-type: none"> a. Select Maps > Maps > Maps. b. Click New. c. Type an alias in the Map Alias field that will help you identify this map.

Task	Description	UI Steps
	to the local tool port.	<ul style="list-style-type: none"> d. Select Regular and By Rule for the map type and subtype. e. Specify the network and tool ports that you configured in task one in the Source and Destination fields, respectively. f. From the GSOP drop-down list, select the GigaSMART operation configured in task 4. g. Click Add a rule under Map Rules and create the following rule: Select IP Version from the drop-down list and select v4 for Version, and then select Pass. h. Click Save.

Example 5 – GigaSMART L2GRE IPv6 Tunnel Encamp/Decap with Load-Balancing

In this example, the encapsulation and decapsulation nodes are configured with IP interfaces using IPv6 addresses and load-balancing. IPv6 tunnel load-balancing feature supports the distribution of traffic across multiple IPv6 tunnel destination through the same tool port. Two types of load-balancing is supported, stateful and stateless.

To access GigaSMART within GigaVUE-FM, access a device that has been added to GigaVUE-FM from the GigaVUE-FM interface. GigaSMART appears in the navigation pane of the device view on supported devices. Refer to [Access GigaSMART from GigaVUE-FM](#) for details.

Step 1: Configure a tool type of port and a network type of port.

Create a map using the tunnel encapsulation GigaSMART operation, with packets coming from the network port and being sent to the Internet through the tool port.

1. Select **Ports > Ports > All Ports**.
2. Click **Quick Port Editor**.
3. Use **Quick search** to find the ports to configure.
4. Set the **type for each port** and select **Enable**.
 - a. type: tool - port 1/3/x7
 - b. type: network - 1/3/x8

Step 2: Configure a GigaSMART group and associate it with a GigaSMART engine port.

1. From the device view, select **GigaSMART > GigaSMART Groups**.

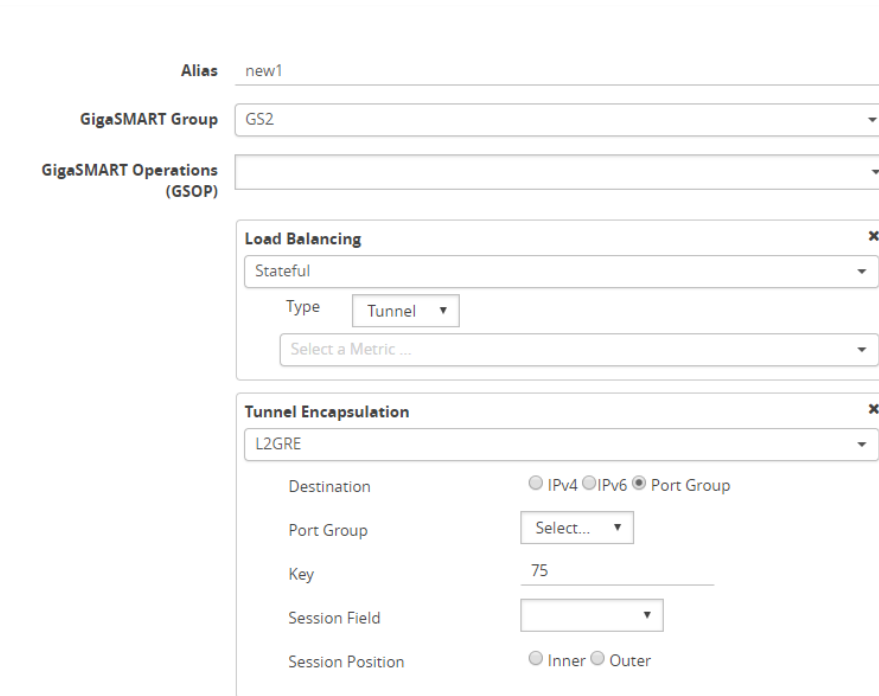
2. Click **New**.
3. Type an **alias** in the Alias field and enter an **engine port** in the Port List field.
4. Click **OK**.

Step 3: Configure the IP Interface

1. Select **Ports > IP Interfaces**.
2. Click **New**.
3. In the **Alias** and **Comment** fields, enter the name and description for the IP interface.
4. Click the **Ports field** and select the port from the drop-down list.
5. Select the Port address: **IPv6**
6. Enter the **IP address, subnet mask, gateway, and MTU** settings in the respective fields.
7. From the **GS Group** drop-down list, select the required GigaSMART group.
8. Click **OK**.

Step 4: Configure the GigaSMART operation for tunnel encapsulation and load balancing and assign it to the GigaSMART group

1. From the device view, select **GigaSMART > GigaSMART Operations > GigaSMART Operation**.
2. Click **New**.



The screenshot shows a configuration form for a GigaSMART operation. At the top, there are three main fields: 'Alias' with the value 'new1', 'GigaSMART Group' with a dropdown menu showing 'GS2', and 'GigaSMART Operations (GSOP)' with a dropdown menu. Below these are two expandable panels. The first panel, 'Load Balancing', has a dropdown set to 'Stateful', a 'Type' dropdown set to 'Tunnel', and a 'Select a Metric ...' dropdown. The second panel, 'Tunnel Encapsulation', has a dropdown set to 'L2GRE'. It contains several fields: 'Destination' with radio buttons for 'IPv4', 'IPv6', and 'Port Group' (the latter is selected); 'Port Group' with a 'Select...' dropdown; 'Key' with the value '75'; 'Session Field' with a dropdown; and 'Session Position' with radio buttons for 'Inner' and 'Outer'.

Figure 499: GigaSMART Operation (GSOP)

3. In the **Alias** field, enter a name for the GigaSMART operation.
4. From the **GigaSMART Group** drop-down list, select the **GigaSMART Group** that you created in the step 2.
5. From the **GigaSMART Operations (GSOP)** drop-down list, select **Tunnel Encapsulation**.
6. Select **L2GRE** for the encapsulation type.
7. Enter the **GRE key 123214** in the Key field.
8. Click **OK**.

Step 5: Create a map using the tunnel encapsulation GigaSMART operation

1. Select **Maps > Maps > Maps**.
2. Click **New**.

The screenshot shows the configuration interface for a map. It is organized into three main sections:

- Map Info:** Contains fields for Map Alias (demo_rr), Comments, Type (Regular), Subtype (By Rule), and No Rule Matching (Pass Traffic).
- Map Source and Destination:** Contains a Port Editor, Source (1/4x24), Destination (1/4x24), and GigaSMART Operations (GSOP) (demo_rr (demo)).
- Map Rules:** Contains buttons for Quick Editor, Import, and Add a Rule. It shows a rule configuration with Condition search..., Pass action, and IP Version protocol with a value of 17.

Figure 500: Map Configuration

3. Type an **alias** in the Map Alias field that will help you identify this map.
4. Select **Regular** and **By Rule** for the map type and subtype.
5. Specify the **network and tool ports** that you configured in step one in the Source and Destination fields, respectively.
6. From the GSOP drop-down list, select the **GigaSMART operation** configured in step 4.
7. Click **Add** a rule under Map Rules.
8. Select **IP Version** from the drop-down list and select **v4** for Version.
9. Select **Pass**.
10. Click **Add a rule** under Map Rules and create the following rule:
11. Select **IP Version** from the drop-down list and select **v6** for Version.
12. Select **Pass**.
 - a. Source: **From - 1/4x24**
 - b. Destination: **To: 1/4x7**
13. Click **OK**.

On the decapsulation node, configure the receiving end of the tunnel

Step 6: Configure a tool type of port and a network type of port.

1. Select **Ports > Ports > All Ports**.

2. Click **Quick Port Editor**.
3. Use **Quick search** to find the ports to configure.
4. Set the **type for each port** and select **Enable**.
 - a. type: tool - port 1/4/x7
 - b. type: network - 1/4/x24

Step 7: Configure a GigaSMART group and associate it with a GigaSMART engine port.

1. From the device view, select **GigaSMART > GigaSMART Groups**.
2. Click **New**.
3. Type an **alias** in the Alias field and enter an **engine port** in the Port List field.
 - a. engine port: **1/3/e1**
4. Click **OK**.

Step 8: Configure the IP Interface with an IPv6 address, prefix length, default gateway, and MTU setting. Assign it to the GigaSMART group.

1. Select **Ports > IP Interfaces**.
2. Click **New**.
3. In the **Alias** and **Comment** fields, enter the name and description for the IP interface.
4. Click the **Ports field** and select the port from the drop-down list.
5. Enter the **IP address, subnet mask, gateway, and MTU settings** in the respective fields.
6. From the **GS Group** drop-down list, select the required GigaSMART group.
7. Click **OK**.

Step 9: Configure the GigaSMART operation for tunnel decapsulation and assign it to the GigaSMART group.

1. From the device view, select **GigaSMART > GigaSMART Operations > GigaSMART Operation**.
2. Click **New**.
3. In the **Alias** field, enter a name for the GigaSMART operation.
4. From the **GigaSMART Groups** drop-down list, select the GigaSMART Group.

5. From the **GigaSMART Operations (GSOP)** drop-down list, select **Tunnel Decapsulation**.
6. Select **L2GRE** for the decapsulation type.
7. Enter the **GRE** key in the Key field.
8. Click **OK**.

Step 10: Create a map using the tunnel decapsulation GigaSMART operation.

1. Select **Maps > Maps > Maps**.
2. Click **New**.
3. Type an **alias** in the Map Alias field that will help you identify this map.
4. Select **Regular and By Rule** for the map type and subtype.
5. Specify the **network and tool ports** that you configured in task one in the Source and Destination fields, respectively.
6. From the **GSOP** drop-down list, select the GigaSMART operation.
7. Click **Add a rule** under Map Rules and create the following rule:
8. Select **IP Version** from the drop-down list and select **v4** for Version.
9. Select **Pass**.
10. Click **Add a rule** under Map Rules and create the following rule:
11. Select **IP Version** from the drop-down list and select **v6** for Version.
12. Select **Pass**.
 - a. Source: **From - 1/4x24**
 - b. Destination: **To: 1/4x7**
13. Click **OK**.

Display L2GRE IPv6 Tunnel Statistics

To view IP Interfaces statistics, **select Ports > IP Interfaces > Statistics** to open the IP Interfaces Statistics page.

The IPv6 tunnel statistics pane displays the gateway status as **Reachable** if neighbor discovery is completed with gateway or **Unreachable** if neighbor discovery failed. Neighbor discovery is done only on the encapsulation node. On the decapsulation node, the gateway status will be **Not Applicable**.

Display L2GRE Tunnel Encapsulation Statistics

To display Layer 2 GRE tunnel encapsulation statistics, select **GigaSMART > GigaSMART Operations (GSOP) > Statistics**. The statistics for tunnel encapsulation will be in the row labeled Tunnel Encap in the GS Operations column.

Refer to [Tunnel Encapsulation Statistics Definitions](#) for descriptions of these statistics as well as to [GigaSMART Operations Statistics Definitions](#).

Display L2GRE Tunnel Decapsulation Statistics

To display Layer 2 GRE tunnel decapsulation statistics, select **GigaSMART > GigaSMART Operations (GSOP) > Statistics** and click on the GS Operation in table to open the Quick View for GS Operation Statistics.

Refer to [Tunnel Decapsulation Statistics Definitions](#) for descriptions of these statistics as well as to [GigaSMART Operations Statistics Definitions](#).

IP Fragmentation and Reassembly on L2GRE and GMIP Tunnels

Starting in software version 4.6, L2GRE and GMIP tunnels support IP fragmentation and reassembly of packets. IP fragmentation occurs with encapsulation. Fragmented packets are sent on the tool port at the sending end of the tunnel (for example, at a remote site). IP reassembly occurs with decapsulation. Fragmented packets reaching the network port at the receiving end of the tunnel (for example, at a main office site), are decapsulated and reassembled before being sent to the destination.

IP Fragmentation on Encapsulation

The tool port at the remote site is configured with a tunnel MTU. If a packet exceeds the tunnel MTU, the packet will be fragmented, and the fragmented packets will be sent out the IP interface.

NOTE: Each fragmented packet will contain the tunnel header.

The packet size plus the tunnel header size is calculated and checked against the tunnel MTU. For example, if the tunnel MTU is 1518 and the packet is 1526, the packet exceeds the tunnel MTU. If the tunnel MTU is 1518 and the packet is 1518, the packet will also exceed the tunnel MTU due to the addition of the tunnel header.

IPv6 tunnel supports Path MTU. When a GigaSMART (GSOP) is associated to a map, Path MTU discovery message is sent to the tunnel destination and the Path MTU learnt is used for IPv6 fragmentation.

IP Reassembly on Decapsulation

The network port at the main office site receives the fragmented packets sent from the remote site. The tunnel header is removed from all fragmented packets, and they are buffered in memory. After all the fragmented packets are available, they are reassembled. The reassembled packet is then sent to the tool.

Notes and Considerations

Take into account the following notes and considerations:

Feature	Description
IPv4 and IPv6 Support	<p>IPv4 and IPv6 packets are supported.</p> <p>Note: To avoid the overhead and improve the performance, existing GMIP IPv4 tunneling does not calculate the UDP Checksum on the Encapsulated Packets. The same will be adopted for IPv6 and IPv6 RFCs, where the checksum value will be set to 0. UDP checksum of the out header is not mandatory in the IPv6 tunneling.</p>
Always Enabled	<p>IP fragmentation and reassembly are always enabled. No configuration is required.</p>
Tunnel MTU	<p>The tunnel MTU is configured using the MTU field on the IP Interfaces configuration page. (Select Ports > IP Interfaces, and then click New to open the page.)</p> <p>The MTU is fixed at 9400 for all network/tool ports on the following platforms except the following</p> <ul style="list-style-type: none"> • GigaVUE-TA10, and GigaVUE-TA40 • Certified Traffic Aggregation White Box <p>The MTU is fixed at 9400 for all network/tool ports on the following platforms:</p> <ul style="list-style-type: none"> • GigaVUE-HC2 and GigaVUE-HC2 equipped with Control Card version 2 (HC2 CCv2) • GigaVUE-HC1 • GigaVUE-HC3 • GigaVUE-TA100
Encapsulation Statistics	<p>The encapsulation statistics count the number of fragmented packets. Refer to Display GMIP Tunnel Encapsulation Statistics and Display L2GRE Tunnel Encapsulation Statistics. For definitions, refer to Tunnel Encapsulation Statistics Definitions.</p>
Decapsulation Statistics	<p>The decapsulation statistics count the number of reassembled packets. Refer to Display GMIP Tunnel Decapsulation Statistics and Display L2GRE Tunnel Decapsulation Statistics. For definitions, refer to Tunnel Decapsulation Statistics Definitions.</p>
GigaSMART Engine Ports	<p>GigaSMART operations with a tunnel component can only be assigned to GigaSMART groups consisting of a single GigaSMART engine port. Refer to Groups of GigaSMART Engine Ports for details.</p>

GigaSMART ERSPAN Tunnel Decapsulation

Required License for ERSPAN Decapsulation: Advanced Tunneling (GigaVUE-HC2, and GigaVUE-HC3), Tunneling (GigaVUE-HC1)

Some Cisco equipment provides the ability to mirror monitored traffic to a remote destination through an ERSPAN tunnel. Using ERSPAN tunnel decapsulation, GigaSMART can act as the receiving end of an ERSPAN tunnel, decapsulating mirrored traffic sent over the Internet from a Cisco switch or router.

Both ERSPAN Type II and Type III header decapsulation are supported. For ERSPAN Type III details, refer to [ERSPAN Type III](#).

You can configure a GigaSMART-enabled node to act as the receiving end of an ERSPAN tunnel by configuring a GigaSMART **Tunnel Decapsulation** operation with type set to **ERSPAN** and a **Flow ID** matching the sending end of the tunnel.

The high-level steps are as follows:

1. Configure an IP interface associated with network port and assign an IP address, subnet mask, and default gateway to the IP interface. The IP address must match the destination IP address specified at the sending end of the tunnel.
2. Create a GigaSMART operation with an ERSPAN tunnel decapsulation component. The decapsulation settings include the same flow ID specified at the sending end of the tunnel. The flow ID is a value from 0 to 1023. Use this options when decapsulating traffic received over a Cisco-standard ERSPAN tunnel. A flow ID of 0 decapsulates all ERSPAN tunnel traffic regardless of flow ID.
3. For ERSPAN Type III, a trailer timestamp may be specified.
4. Bind the GigaSMART operation to the IP interface associated with network port as part of a map that distributes arriving traffic to local tool ports for analysis with local tools.

For example configurations, refer to [ERSPAN Tunnel Header Removal](#) and [ERSPAN Type III Tunnel Header Removal](#).

For an example of APF and ERSPAN tunneling, refer to [ERSPAN Tunneling](#).

ERSPAN Type III

ERSPAN Type III is similar to ERSPAN Type II but has a hardware timestamp in the packet. The hardware timestamp needs to be translated into a usable timestamp.

The UTC timestamp can be calculated, based on the reference hardware timestamp and the reference UTC timestamp carried in marker packets that are periodically sent over UDP. The calculated UTC timestamp can then be appended to the packets as a trailer.

Marker packets have a fixed length and are identified by a signature of 0xA5A5A5A5. If the marker packet session ID matches the ERSPAN session ID, the UTC timestamp can be extracted from the marker packet. An ERSPAN session is defined by a map that uses an ERSPAN GigaSMART operation (gsop).

There are three timestamp formats: **None**, **GigaSMART**, and **X12-TS** (for PRT-H00-X12TS). The timestamp options are set from the GigaSMART Group page, which is accessed by selecting **GigaSMART > GigaSMART Groups > GigaSMART Groups**, and then clicking **New** or editing an existing GigaSMART Group. [Figure 501: ERSPAN Type III Timestamp Formats on GigaSMART Groups Page](#) shows the timestamp format options. If the timestamp format is **Disabled**, ERSPAN Type III packets are parsed and the ERSPAN header is removed by GigaSMART. The inner packets are forwarded to a tool port. If the timestamp format is **GigaSMART** or **X12-TS**, a trailer containing the recovered timestamp is added to the inner packets before they are forwarded to a tool port.

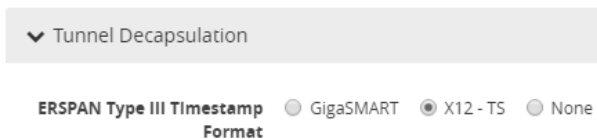


Figure 501: ERSPAN Type III Timestamp Formats on GigaSMART Groups Page

The GigaSMART timestamp is added to the Gigamon trailer. For the format of the GigaSMART trailer, refer to [GigaSMART Trailer Reference](#). The x12-ts timestamp is added to the PRT-H00-X12-S trailer. For the format of the PRT-H00X12TS trailer, refer to the *GigaVUE-OS-CLI Reference Guide*.

Only 10 ERSPAN sessions are supported per GigaSMART Group (gsgroup) when the timestamp format is configured to **GigaSMART** or **X12-TS**.

In summary for ERSPAN Type III encapsulation, **GigaSMART** does the following:

- strips encapsulating Ethernet + outer IP + GRE + ERSPAN Type III headers from incoming packets
- uses the timestamp field in ERSPAN packets and calculates the UTC timestamp, based on the timestamp in marker packets
- appends the UTC timestamp to the GigaSMART trailer or the PRT-H00-X12TS trailer if either **GigaSMART** format or PRT-HD00-X12TS (**X12-TS**) format is configured
- forwards packets to tool ports

ERSPAN Granularity

ERSPAN granularity is a setting that can be configured on the Cisco switch for the level of detail of the hardware timestamp in marker packets.

A marker packet will be considered overdue if it does not arrive by the following times:

- 00: Granularity—overdue after 119 hours
- 01: Granularity—overdue after 430 seconds (7 minutes)
- 10: 1588 PTP—overdue after 4.3 seconds

ERSPAN statistics include a count of overdue packets. Refer to [Display ERSPAN Statistics](#) for how to display the output and to [ERSPAN Statistics Definitions](#) for descriptions of these statistics.

PRT-H00-X12TS Unique ID

For the PRT-H00-X12TS format, you can obtain a unique ID identifying the port on which packets arrive. Use the following CLI command to display the mapping of ports to unique IDs:

(config) # show apps netflow port-id

```

=====
Port          Netflow port-id
-----
1/1/x1       1
1/1/x2       2
1/1/x3       3
1/1/x4       4
1/1/x5       5
1/1/x6       6
1/1/x7       7
1/1/x8       8
1/1/x9       9
1/1/x10      10
1/1/x11      11
1/1/x12      12
-----

```

Configure GigaSMART Operations for ERSPAN

Use the GigaSMART Operation (GSOP) page to configure the ERSPAN decapsulation types and options. For example, you can specify an ERSPAN flow ID, from 0 to 1023. Use this option when decapsulating traffic received over a Cisco-standard ERSPAN tunnel. Both ERSPAN Type II and Type III header decapsulation are supported.

To access GigaSMART within GigaVUE-FM, access a device that has been added to GigaVUE-FM from the GigaVUE-FM interface. GigaSMART appears in the navigation pane of the device view on supported devices. Refer to [Access GigaSMART from GigaVUE-FM](#) for details.

ERSPAN Tunnel Header Removal

To configure a tunnel to capture the ERSPAN packets, remove the ERSPAN header, and then forward the packets to a tool port, set the ERSPAN Decapsulation Flow ID to zero when creating the GigaSMART operation as shown in [Figure 502: Decapsulation Flow ID Set to Zero.](#)

NOTE: A flow ID of zero is a wildcard value that matches all flow IDs.

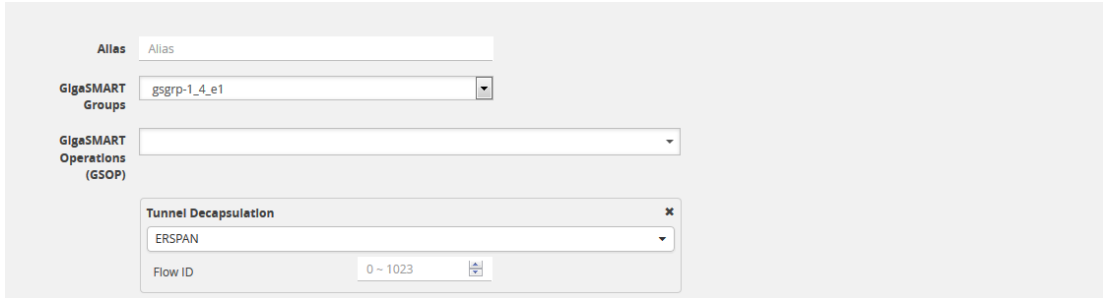


Figure 502: Decapsulation Flow ID Set to Zero.

In the following example, a tunnel is configured to capture ERSPAN packets, then the ERSPAN header is removed and the packets are forwarded to a tool port.

Task	Description	UI Steps
1.	Configure a tool type of port.	<ol style="list-style-type: none"> Select Ports > All Ports. Click Quick Port Editor. Use Quick search to find the ports to configure. For example, 1/1/g1. Set the type to Tool and select Enable. Click OK.
2.	Configure a GigaSMART group and associate it with a GigaSMART engine port.	<ol style="list-style-type: none"> From the device view, select GigaSMART > GigaSMART Groups > GigaSMART Groups. Click New. Type an alias in the Alias field (for example, gsgrp1) and enter an engine port in the Port List field (for example 1/3/e1). Click Save.
3.	Configure the IP interface.	<ol style="list-style-type: none"> Select Ports > IP Interfaces. Click New. On the IP Interfaces page, in the Alias and Comment fields, enter the name and description for the IP interface.

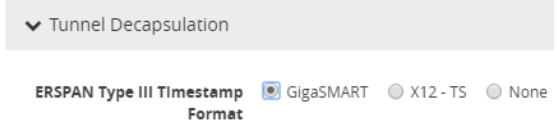
Task	Description	UI Steps
		<ul style="list-style-type: none"> d. Click the Ports field and select the port from the drop-down list. e. Enter the IP address, subnet mask, gateway, and MTU settings in the respective fields. For example, port 1/1/g2, IP address 10.10.10.10, mask 255.255.225.0, gateway 0.10.10.1, and MTU 1500. f. Click on the GigaSMART Group field to select the GigaSMART group. g. Click Save.
4.	Configure the GigaSMART operation and assign it to the GigaSMART group. <div style="border: 1px solid #ccc; padding: 5px; margin-top: 10px;"> <p>NOTE: A flow ID of zero is a wildcard value that matches all flow IDs.</p> </div>	<ul style="list-style-type: none"> a. From the device view, select GigaSMART > GigaSMART Operations > GigaSMART Operation. b. Click New. c. Type an alias in the Alias field. d. From the GigaSMART Groups drop-down list, select the GigaSMART Group that you created in the second task. e. From the GigaSMART Operations (GSOP) drop-down list, select Tunnel Decapsulation. f. Select ERSPAN for the decapsulation type. g. Enter a value of 0 in the Flow ID field. The configuration should look like the example shown in Figure 502: Decapsulation Flow ID Set to Zero.. h. Click Save.
5.	Create a map.	<ul style="list-style-type: none"> a. Select Maps > Maps > Maps. b. Click New. c. Type an alias in the Map Alias field that will help you identify this map. d. Select Regular and By Rule for the map type and subtype. e. Specify the network and tool ports in the Source and Destination fields, respectively. f. From the GSOP drop-down list, select the GigaSMART operation configured in task 4. g. Click Add a rule under Map Rules and create the following rule: Select IPv4 Protocol from the drop-down list and select GRE for Value, and then select Pass. h. Click Save.

ERSPAN Type III Tunnel Header Removal

In this example, a tunnel is configured to capture ERSPAN packets. ERSPAN Type III packets are parsed, the ERSPAN header is removed, and the timestamp is calculated. A timestamp trailer is added before the packets are forwarded to a tool port.

NOTE: A flow ID of zero is a wildcard value that matches all flow IDs.

Task	Description	UI Steps
1.	Configure a port of type tool.	<ol style="list-style-type: none"> a. Select Ports > Ports > All Ports. b. Click Quick Port Editor. c. In the Quick View Editor, find the port to configure. d. Set Type to Tool. e. Select Enable f. Click OK. g. Close the Quick Port Editor.
2.	Configure a GigaSMART group and associate it with a GigaSMART engine port.	<ol style="list-style-type: none"> a. From the device view, select GigaSMART > GigaSMART Groups > GigaSMART Groups. b. Click New. c. Enter a name in the Alias field d. Select the engine port in the Port List field. e. Click Save.
3.	Configure the IP interface.	<ol style="list-style-type: none"> a. Select Ports > IP Interfaces. b. Click New. c. On the IP Interfaces page, in the Alias and Comment fields, enter the name and description of the IP interface. d. Click the Ports field and select the tool port from the drop-down list. e. Enter the IP address, subnet mask, gateway, and MTU settings in the respective fields. For example, port 1/1/g2, IP address 10.10.10.10, mask 255.255.225.0, gateway 0.10.10.1, and MTU 1500. f. Click on the GigaSMART Group field to select the GigaSMART group. g. Click Save.
4.	Configure the GigaSMART operation and assign it to the GigaSMART group. <div style="border: 1px solid #ccc; padding: 5px; margin-top: 10px;"> <p>NOTE: A flow ID of zero is a wildcard value that matches all flow IDs.</p> </div>	<ol style="list-style-type: none"> a. From the device view, select GigaSMART > GigaSMART Operations (GSOP) > GigaSMART Operation. b. Click New. c. Type an alias in the Alias field. d. From the GigaSMART Groups drop-down list, select the GigaSMART Group that you created in the second task. e. From the GigaSMART Operations (GSOP) drop-down list, select Tunnel Decapsulation. f. Select ERSPAN for the decapsulation type. g. Enter a value of 0 in the Flow ID field. The configuration should look like the example shown in Figure 502: Decapsulation Flow ID Set to Zero..

Task	Description	UI Steps
		<p>h. Click Save.</p>
5.	Configure a timestamp trailer format.	<p>a. From the device view, select GigaSMART > GigaSMART Group.</p> <p>b. Select the GigaSMART Group created in Task 2.</p> <p>c. Under GigaSMART Parameters, go to Tunnel Decapsulation.</p> <p>d. For ERSPAN Type III Timestamp Format, select GigaSMART</p>  <p>e. Click Save.</p>
6.	Create a map. The map contains a rule to allow marker packets (UDP) to be processed.	<p>a. Select Maps > Maps > Maps.</p> <p>b. Click New.</p> <p>c. Type an alias in the Map Alias field that will help you identify this map.</p> <p>d. Select Regular and By Rule for the map type and subtype.</p> <p>e. Specify a network ports in the Source fields.</p> <p>f. Select the tool port configured in Task 1 in the Destination field</p> <p>g. From the GSOP drop-down list, select the GigaSMART operation configured in task 4.</p> <p>h. Click Add a Rule and create the first rule. Select Pass, then select IPv4 Protocol, and then select GRE fro Value.</p> <p>i. Click Add a Rule and create the second rule. Select Pass, then select IPv4 Protocol, and then select UDP for Value.</p> <p>j. Click Save.</p>

Display ERSPAN Statistics

To display ERSPAN statistics, select **GigaSMART > GigaSMART Operations (GSOP) > Statistics**. The ERSPAN statistics will be in the row labeled Tunnel Decap in the GS Operations column.

Refer to [ERSPAN Statistics Definitions](#) for descriptions of these statistics as well as to [GigaSMART Operations Statistics Definitions](#).

GigaSMART VXLAN Tunnel Decapsulation

Required License for VXLAN Decapsulation: Base (GigaVUE-HC2, and GigaVUE-HC3), Tunneling (GigaVUE-HC1)

Starting in software version 5.3, support for VXLAN tunnel termination is added to GigaSMART. VXLAN encapsulated packets originating from any device, such as the Gigamon cloud or a customer-specific device, will be received on a network port, then will be terminated at GigaSMART. The VXLAN payload (the inner packet) will be sent to tools. The reassembly of fragmented IP packets is also supported.

This section only includes VXLAN tunnel termination. It does not include VXLAN origination. To terminate a custom tunnel header that is not known to GigaSMART, use custom tunnel termination. Refer to [GigaSMART Custom Tunnel Decapsulation](#)

You can configure a GigaSMART-enabled node to act as the receiving end of a VXLAN tunnel by configuring a GigaSMART **tunnel-decap** operation with **type** set to **vxlan**. The high-level steps are as follows:

1. Configure an IP interface associated with network port and assign an IP address, subnet mask, and default gateway to the IP interface. The gateway forwards the encapsulated packet to the network port.
2. Create a GigaSMART operation with a **vxlan** decapsulation component.
3. Bind the GigaSMART operation to the IP interface associated with network port as part of a map.

At GigaSMART, VXLAN encap packets are received on the network port. After validation of the source port, destination port, and VXLAN Network Identifier (VNI) of the packet, the VXLAN tunnel header will be removed and the inner payload will be sent to a subsequent GSOP or to the tools.

The VNI in the VXLAN header is validated against the user VNI provided. If it does not match, the packet will be dropped and counted as an error.

A VXLAN packet is identified using the **portdst** parameter. The destination port can be 4789, or any user-configured port number from 1 to 65535.

For an example configuration, refer to [VXLAN Tunnel Termination Example](#)

NOTE: GigaSMART operations with a tunnel component can only be assigned to GigaSMART groups consisting of a single GigaSMART engine port.

VXLAN Tunnel Termination Example

To access GigaSMART within GigaVUE-FM, access a device that has been added to GigaVUE-FM from the GigaVUE-FM interface. GigaSMART appears in the navigation pane of the device view on supported devices. Refer to [Access GigaSMART from GigaVUE-FM](#) for details.

To configure a VXLAN tunnel termination:

Step 1: Configure a Tool Port

1. Select **Ports > Ports > All Ports**.
2. Click **Quick Port Editor**.
3. Configure an available port as follows:
 - Select Tool in the **Type** field.
 - Enter an alias in the **Alias** field. For example, 1/4/x2.
 - Check the **Enable** check box.
4. Click **OK** to save the port.
5. Close the Quick Port Editor.

Step 2: Configure a GigaSMART group and associate it with a GigaSMART engine port.

1. From the device view, select **GigaSMART > GigaSMART Groups > GigaSMART Groups**.
2. Click **New**.
3. Type an alias in the **Alias** field. For example, gsg.
4. Select an engine port in the **Port List** field. For example, 1/3/e2. (All engine ports have an 'e')
5. Click **OK** to save the GigaSMART group.

Step 3: Configure the IP Interface

1. Select **Ports > IP Interfaces**.
2. Click **New**.
3. In the **Alias** and **Comment** fields, enter the name and description for the IP interface.
4. From the **Port** field, select any available network port. In this example, port 1/2/x1.
5. Complete the fields to configure the IP Interface:
 - Enter an **IP Address**. For example, 10.115.9.5.

- Enter a **Mask**. For example, 255.255.255.0.
 - Enter a **Gateway**. For example, 10.115.9.1.
 - Enter the maximum transmission unit (MTU) for this port in the **MTU** field. For example, 1500.
 - Select the **GigaSMART Group** you created in step 2 of this process (gsg).
6. Click **OK** to save the IP interface configuration.

Step 4: Configure GigaSMART operation and assign to the GigaSMART Group

1. From the device view, select **GigaSMART > GigaSMART Operations (GSOP) > GigaSMART Operation**.
2. Click **New**.
3. Type an alias in the **Alias** field to identify this operation. For example, vxlan2.
4. For **GigaSMART Groups**, select the group created in step 2 of this process (gsg).
5. For **GigaSMART Operations (GSOP)**, select Tunnel Decapsulation.

A Tunnel Decapsulation form appears. Complete the fields as follows:

- Select "VXLAN" as the **Type**.
 - Enter a **Source Port**.
 - Enter a **Destination Port**.
 - Enter a **VNI**.
6. Click **OK** to save the GSOP.

Step 5: Create a Map

1. Select **Maps > Maps > Maps**.
2. Click **New**.
3. Configure the map.
 - Type an alias in the **Alias** field.
 - For **Type**, leave the default (Regular).
 - For **Subtype**, leave the default (By Rule).
 - For **Source**, select the IP interface you configured in step 3 (1/2/x1).
 - For **Destination**, select the tool port you configured in step 1 (1/4/x2).
4. Under Map Rules, click **Add a Rule**.
 - Select **IP Version** from the drop list and set IP Version to **v4** when prompted.
 - Select **Pass** radio button for rule type.
 - Click **OK**.

Display VXLAN Tunnel GSOP

To display the VXLAN Tunnel GigaSMART operation:

1. From the device view, select **GigaSMART > GigaSMART Operations (GSOP)**.
2. Select the VXLAN tunnel GSOP that you created in step 4 (vxlan2). The GSOP quick view appears.

Display VXLAN Tunnel Statistics

To display VXLAN tunnel statistics:

1. From the device view, select **GigaSMART > GigaSMART Operations (GSOP) > Statistics**.
The Statistics page displays all GSOP statistics in a table format.
2. In the table view, click the VXLAN tunnel GSOP alias that you created in step 4 (vxlan2) to display the Statistics quick view.

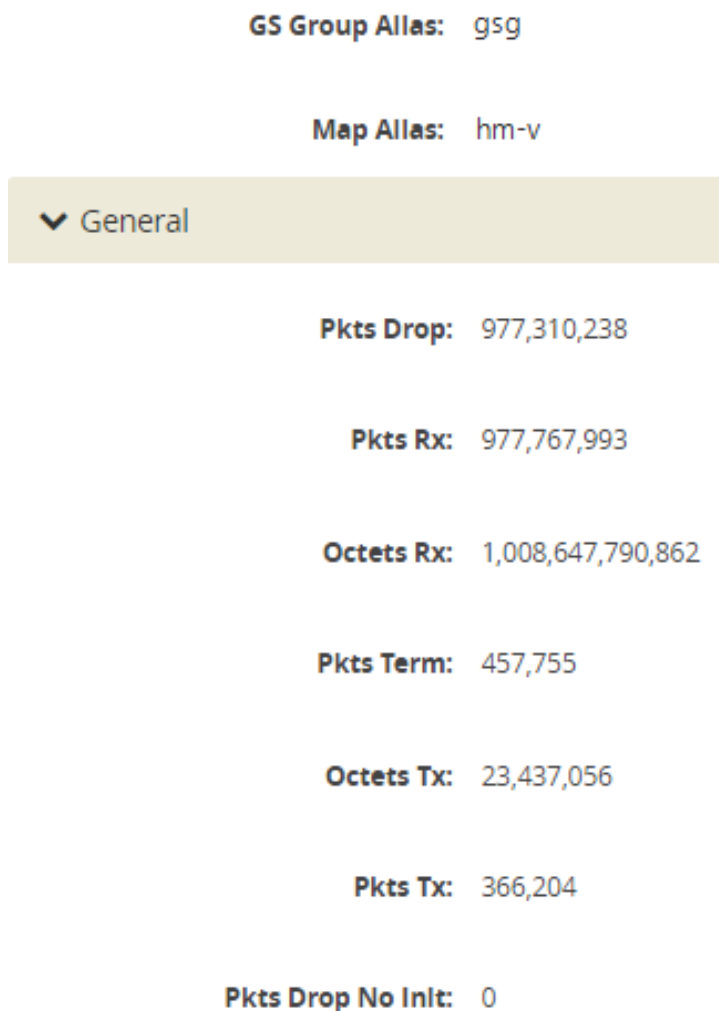


Figure 503: GSOP VXLAN Statistics Quick View

GigaSMART Custom Tunnel Decapsulation

Required Licenses for Custom Decapsulation: Base (GigaVUE-HC2, and GigaVUE-HC3), Tunneling (GigaVUE-HC1), and Header Stripping

Starting in software version 5.3, support for custom tunnel termination is added to GigaSMART. Use custom tunnel termination to terminate a custom tunnel header that is received at the IP interface that is associated with a network port, but is not known to GigaSMART. The destination IP and MAC addresses must match the IP and MAC addresses of the network tunnel.

The packets that are successfully received at GigaSMART on a custom tunnel can be stripped, after some validations are performed, or can be sent to tools. The existing generic header stripping operation can be leveraged to remove the tunnel header if required. The reassembly of fragmented IP packets is also supported.

You can configure a GigaSMART-enabled node to act as the receiving end of a tunnel by configuring a GigaSMART **tunnel-decap** operation with **type** set to **custom** and Layer 4 (L4) source and destination ports. The high-level steps are as follows:

1. Configure an IP interface associated with network port and assign an IP address, subnet mask, and default gateway to the IP interface. The gateway forwards the encapsulated packet to the IP interface that is associated with a network port.
2. Create a GigaSMART operation (GSOP) with a **custom** decapsulation component.
3. (Optional) Create a chain of GigaSMART operations containing the custom tunnel decap GSOP and a generic header stripping GSOP.
4. Bind the GigaSMART operation to the P interface that is associated with a network port as part of a map.

The encapsulated packet will go from the P interface that is associated with a network port to GigaSMART, where basic validation against configured values will be performed. The packet will then be sent to the chained GSOPs, where the encapsulated header will be stripped off (if configured to strip) and sent to the tools.

NOTE: The generic header stripping operation is performed on the inner payload of the tunneled packet. Use a hybrid port for the header stripping GSOP.

For an example configuration, refer to [Custom Tunnel Decapsulation Configuration Example](#)

NOTE: GigaSMART operations with a tunnel component can only be assigned to GigaSMART groups consisting of a single GigaSMART engine port.

Custom Tunnel Decapsulation Configuration Example

To access GigaSMART within GigaVUE-FM, access a device that has been added to GigaVUE-FM from the GigaVUE-FM interface. GigaSMART appears in the navigation pane of the device view on supported devices. Refer to [Access GigaSMART from GigaVUE-FM](#) for details.

To configure a custom tunnel termination, do the following:

Configure a GigaSMART group/associate group with GigaSMART Engine Port

1. From the device view, select **GigaSMART > GigaSMART Groups**.
2. Click **New**.
3. Type an **alias** in the Alias field. For example, gsg.
4. Select **Ports > Ports**.
5. Select an engine port. For example, **1/1/g13**.
6. Click **Edit**.
7. Select **Network** for Type and enable **Admin**.
8. Click **OK**.

Configure the IP Interface

1. Select **Ports > IP Interfaces**.
2. Click **New**.
3. In the **Alias** and **Comment** fields, enter the name and description for the IP interface.
4. From the **Port** drop-down list, select port 1/1/g3
5. Enter **10.115.9.5** in the IP Address field.
6. Enter **255.255.255.255** in the Mask field
7. Enter **10.115.9.1** in the Gateway field.
8. Enter **1500** in the MTU field.
9. Select the **GigaSMART Group** you created in the first step of this process. For example: **gsg**.
10. Click **Save**.

Configure GigaSMART operation and assign to GigaSMART Group

1. From the device view, select **GigaSMART > GigaSMART Operations (GSOP) > GigaSMART Operation**.
2. Click **New**.
3. Type an **alias** in the Alias field to identify this operation. For example, custom2
4. For **GigaSMART Groups**, select **gsg**.
5. For **GigaSMART Operations (GSOP)**, select **Tunnel Decapsulation**.
 - a. Select **Custom**

- b. Type **Source Port**
 - c. Type **Destination Port**
6. Click **Save**

Create a Map

1. Select **Maps > Maps > Maps**.
2. Click **New**.
3. Configure the map.
 - Type map11 in the Alias field.
 - Select **T or tool** for **Type**.
 - Select **By Rule** for Subtype.
 - Select the from **network port 1/1/g1** for the Source.
 - Select the virtual port vp1 for the Destination.
4. Add a Rule.
 - a. Click **Add a Rule**.
 - b. Select **Pass**.
 - c. Select **IPv4 Version** and set Version to **v4**.

Click **Save**.

Display Custom Tunnel GSOP

To display the custom tunnel GigaSMART operation, do the following:

1. From the device view, select **GigaSMART > GigaSMART Operations (GSOP)**.
2. Select the custom tunnel from the list. The GSOP displays.

Display Custom Tunnel Statistics

To display custom tunnel statistics, do the following:

1. From the device view, select **GigaSMART > GigaSMART Operations (GSOP) > Statistics**.
2. Select **Statistics**. The Statistics page displays basic tunnel termination details in a table format.
3. Click the **GSOP alias** to display all the statistics available for this GS Operation.

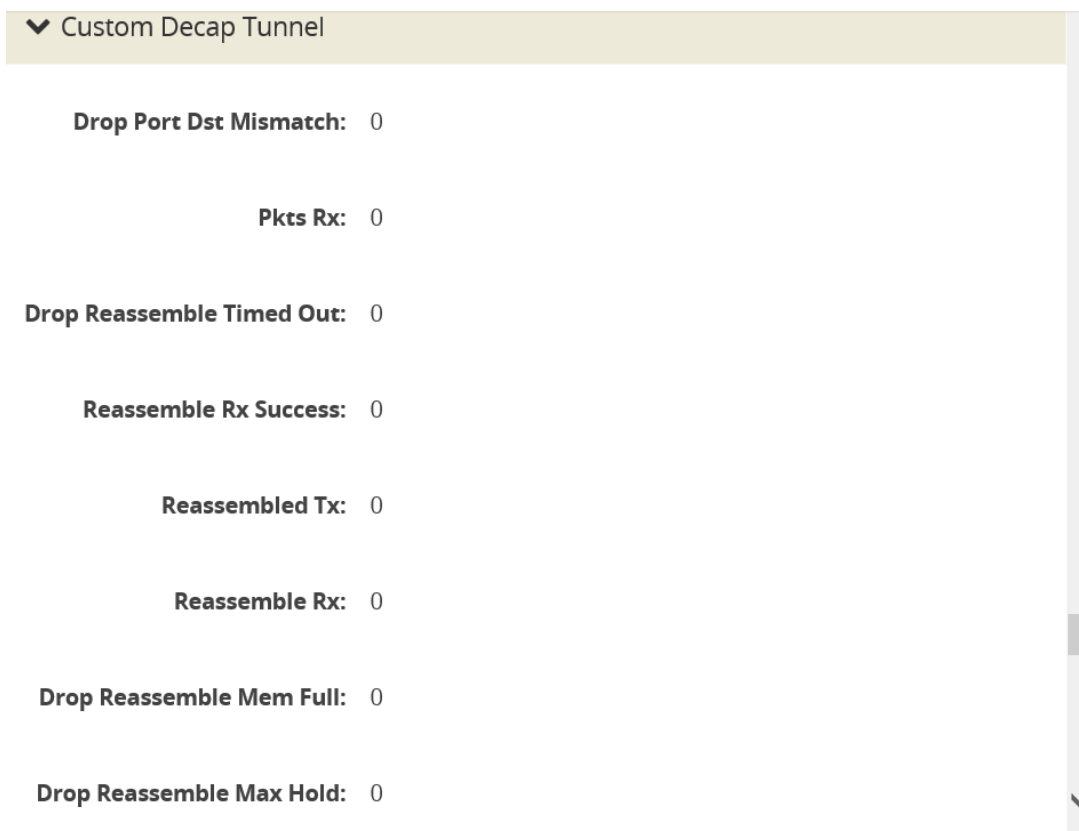
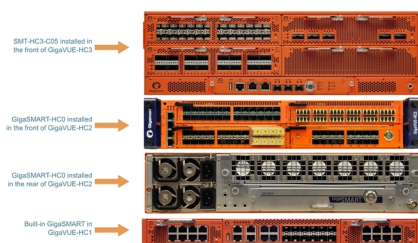


Figure 504:

4. Click the **X** to close the **GS Operation Statistics** pane.

Work with GigaSMART Operations

This chapter describes how to use GigaSMART operations – advanced processing features available for use on GigaVUE-HB1 and GigaVUE-HC1 nodes, GigaVUE-HC2 nodes with front or rear GigaSMART modules, and GigaSMART-HC3 nodes with SMT-HC3-C05 modules ([Work with GigaSMART Operations](#)).



Refer to the following sections for details:

- [About GigaSMART Applications](#)
- [Access GigaSMART from GigaVUE-FM**](#)
- [Create GigaSMART Operations – A Summary](#)
- [Engine Watchdog Timer in GigaSMART](#)
- [GigaSMART Rules and Tips](#)
- [Virtual Ports](#)
- [GigaSMART Operations in Clusters](#)
- [How to Combine GigaSMART Operations](#)
- [Supported GigaSMART Operations](#)
- [GigaSMART Operations ***](#)
- [Order of GigaSMART Operations](#)
- [View GigaSMART Statistics](#)

**Refer to the [Access GigaSMART from GigaVUE-FM](#) for an overview of how to access GigaSMART from GigaVUE-FM.

***Refer to GigaSMART Operations for comprehensive HowTo's on using all GigaSMART operations.

About GigaSMART Applications

GigaSMART applications are packet modification features available on the following GigaVUE H Series nodes:

- Standalone GigaVUE-HC3 with SMT-HC3-C05 module installed.
- Standalone GigaVUE-HC2 with front or rear GigaSMART-HC0 module installed.
- Standalone GigaVUE-HC1 nodes.
- Standalone GigaVUE-HB1 nodes.
- Any GigaVUE H Series node operating in a cluster with one of these node types.

NOTE: This section refers to any of these nodes as **GigaSMART-enabled** – they are all capable of using GigaSMART operations.

You can use both H-VUE and the CLI to create GigaSMART operations combining the GigaSMART applications, and then use them with other map rule criteria, and apply them in map rules on any network port in the node or cluster.

GigaSMART Licensing

GigaSMART Floating Licenses

Flexible floating software licensing options are available for GigaSMART applications with GigaVUE-OS and GigaVUE-FM 5.7.00. Features include:

- A flexible licensing model to include floating licenses, subscriptions licenses, and perpetual licenses.
- New streamlined order management system for subscription licenses.
- Floating licenses are available through the GigaVUE-FM, which now has a License Manager to manage and activate floating licenses.

IMPORTANT: The Gigamon licensing portal now requires a Gigamon Community login to access and activate all software licenses.

NOTE: Existing perpetual licenses that are node-locked to a specific card can still be managed via the GigaVUE-OS CLI, however, the more flexible licensing options (such as trials, floating, and subscriptions) are available through GigaVUE-FM. Some GigaSMART applications, such as De-duplication, Inline SSL, and Application Intelligence, are only available through a subscription license.

NOTE: Refer to the Release Notes v5.7.00 for additional information.

NOTE: Contact your Gigamon Sales Representative to learn more about the available floating license options for your fabric configuration.

Licensing GigaSMART Applications

GigaSMART applications are enabled using license keys. [GigaSMART Applications by License Type](#) summarizes the GigaSMART applications included with the base license, as well as those included with each of the separately available licenses.

Contact your Sales Representative for information on obtaining a license key to enable additional GigaSMART applications. Refer to the **license** command in the GigaVUE-OS CLI Configuration Guide for details.

Note: The "show license" command also displays the start time and end time to support term licenses.

For perpetual licenses, the Expiration Date column has the word Never to indicate that there is no expiration date. For evaluation licenses, the Expiration Date column has a specific date on which the license expires. For more information on evaluation licenses, refer to [GigaSMART Evaluation Licenses](#).

GigaSMART Evaluation Licenses

Use an evaluation license to evaluate GigaSMART applications. During the evaluation period of 45 days, you will have access to the full functionality of the GigaSMART applications under evaluation. You can obtain an evaluation license for any GigaSMART application, for either a single or for a number of GigaSMART applications combined in a bundle.

To obtain an evaluation license, contact your Sales Representative. A license key will be generated by Gigamon and sent to you. You then install the license, which enables the GigaSMART application for evaluation purposes.

Install Evaluation Licenses

You install an evaluation license the same way you install a perpetual license, using the **license** command.

The key consists of a long string beginning with LK2, which is a protocol, followed by the line card or module (SMT_HCO_R), followed by the content of the license key.

Notify Evaluation License Expiry

After installation, the evaluation license will expire after 45 days, on a specific date.

To notify you as the evaluation license approaches the expiry date, you can enable a notification. When enabled, the notification will be sent when there are 30, 15, 10, 5, 4, 3, 2, and 1 days remaining before the license expires.

Use the following CLI command to enable the evaluation license reminder:

```
(config) # snmp-server enable notify evallicensereminder
```

You can also use the **show license** command to display the expiration date of an evaluation license.

Note: The "show license" command now displays the start time and end time to support term licenses.

How to Combine Evaluation and Perpetual Licenses

An evaluation license can be for a number of GigaSMART applications combined in a bundle. If you have a perpetual license for one GigaSMART application, for example, de-duplication, and you want to evaluate a bundle that contains 10 GigaSMART applications, including de-duplication, the 45-day

evaluation period will apply to the other 9 GigaSMART applications, while the perpetual license will apply to de-duplication.

If you obtain a perpetual license after an evaluation license, the perpetual license will overwrite the evaluation license. Overwriting of licenses are allowed only if the current license is 'expired' or 'in grace' period.

GigaSMART Application after Expiry

Once an evaluation license expires, access to the GigaSMART application is disabled. If maps were configured using GigaSMART applications on the evaluation license, traffic will be dropped when the evaluation license expires.

NOTE: Traffic will flow through maps with perpetually licensed GigaSMART applications.

In addition, the **gsop** command will not be available once the evaluation license has expired.

However, if a new evaluation license for the same GigaSMART application is installed, a new 45-day evaluation period will begin.

Move Evaluation and Perpetual Licenses

Evaluation and perpetual license keys are saved on the GigaSMART line card or module, while license information is stored in the configuration database. The license key on the line card or module has to match the license information stored in the database, otherwise a license mismatch will result.

Line cards or modules may sometimes need to be moved or swapped. For the procedure to move a license, refer to [Move Licensed GigaSMART Line Card to a New Slot](#). This procedure will clear a license mismatch under certain circumstances. Moving a license depends on the license type, as well as the expiry date, as follows:

License Key Saved on GigaSMART Line Card/Module	License Information Stored on Configuration Database	Can be Moved?
Perpetual License	Evaluation License	Yes
Evaluation License	Perpetual License	No
Evaluation License with an earlier expiry date than the one stored on the configuration database	Evaluation License	No
Evaluation License with a later expiry date than the one stored on the configuration database	Evaluation License	Yes

Move Licensed GigaSMART Line Card to a New Slot

On the GigaVUE-HC2 or GigaVUE-HC3, you can move a GigaSMART front module from one bay to another. However on the GigaVUE-HC2, you cannot move the GigaSMART rear module from the rear to the front.

If there are no GigaSMART operations (gsops) configured on the line card or module to be moved, you can move the line card or module to the new slot or bay.

If there are GigaSMART operations (gsop), GigaSMART groups (gsgroup), and maps configured on the line card or module to be moved, the system will report a license mismatch if you try to move it without first removing the related configuration.

To clear the settings related to the GigaSMART line card or module from its previous slot, allowing you to create new GigaSMART operations, GigaSMART groups, and maps using the GigaSMART line card or module in its new slot, use the following procedure:

1 Issue the following CLI command:

(config) # show running-config

1. Copy and paste the output to a file such as Notepad, for reference.
2. Remove the map that uses the gsop defined on the gsgroup of the GigaSMART line card or module to be moved, using the following CLI command:

(config) # no map alias <alias>

3. Remove the gsop that was defined on the gsgroup of the GigaSMART line card or module to be moved, using the following CLI command:

(config) # no gsop alias <alias>

4. Remove the gsgroup that was defined on GigaSMART line card or module to be moved, using the following CLI command:

(config) # no gsgroup alias <alias>

5. Issue the following CLI command on GigaSMART line card or module to be moved:

(config) # no card slot <slot ID>

6. Assuming that the new slot does not have a GigaSMART line card or module inserted, issue the following CLI command on the new slot:

(config) # no card slot <slot ID>

7. Issue the following CLI command on the new slot:

(config) # card slot <slot ID>

On the new slot, configure gsgroup, gsop, and reapply the map that uses the gsop on the GigaSMART line card or module.

Access GigaSMART from GigaVUE-FM

You can access GigaSMART operations from within GigaVUE-FM, by accessing a device that has been added to FM from the GigaVUE-FM interface. **GigaSMART** appears in the navigation pane of the device view on supported devices.

To access GigaSMART from the GigaVUE-FM interface:

1. Select **Physical** from the top navigation menu.
2. Select **Physical Nodes** from the side panel. This displays the list of Devices/Cluster Nodes managed by this instance of FM.
3. Click the Cluster ID of any node to open the node. Once you are in the node, this part of the interface should behave just like HVUE for devices that support GigaSMART. Refer to [About GigaSMART Applications](#).
4. Click **GigaSMART** from the side navigation pane.

Refer to:

- [About GigaSMART Applications](#) for devices that support GigaSMART.
- [Create GigaSMART Operations – A Summary](#) to get started with GigaSMART.
- [GigaSMART Operations](#) to learn how to use GigaSMART operations.

Create GigaSMART Operations – A Summary

To access GigaSMART within GigaVUE-FM, access a device that has been added to GigaVUE-FM from the GigaVUE-FM interface. GigaSMART appears in the navigation pane of the device view on supported devices. Refer to [Access GigaSMART from GigaVUE-FM](#) for details.

GigaSMART operations require the following steps:

1. **Create GigaSMART groups on the GigaSMART Groups page (select GigaSMART > GigaSMART Groups > GigaSMART Groups)**

Use GigaSMART groups to manage and budget GigaSMART processing power. Use the **New** button on the GigaSMART Group page to create groups of the available GigaSMART ports in a given chassis.

NOTE: The GigaSMART engine ports in a GigaSMART group can be on different line cards or modules in the same GigaVUE-HC2 chassis. However, all GigaSMART engine ports must be on the same chassis.

The number of GigaSMART engine ports are as follows:

- The GigaSMART-HC0 module includes one GigaSMART engine port.
- The GigaVUE-HB1 node includes one GigaSMART engine port.

The number of GigaSMART engine ports available in a chassis depends on the number of GigaSMART line cards in the chassis—up to five in the GigaVUE-HC2 (four front GigaSMART modules with one GigaSMART engine port each, and one rear GigaSMART module with one GigaSMART engine).

The processing power of the GigaSMART engine ports is as follows:

- Each GigaSMART port on the GigaSMART-HC0 module can process packets at **40Gb**.
- GigaSMART port on the GigaVUE-HB1 node can process packets at **10Gb**.

GigaSMART engine ports are numbered with an **e** prefix using **<bid/sid/e1..e2>** nomenclature – **1/1/e1**, for example.

NOTE: The ports in a GigaSMART group can be on different line cards or modules in the same GigaVUE-HC2 chassis. However, they must all be on the same chassis.

NOTE: The slot ID for a GigaVUE-HB1 chassis is fixed at **1**.

NOTE: The bay ID for a GigaVUE-HC2 with a rear GigaSMART module is fixed at **5**. The bay ID for a GigaVUE-HC2 with GigaSMART front modules, will be 1 to 4, depending on where the module or modules are installed.

Each GigaSMART operation you create in the next step must be assigned to one of the GigaSMART groups you create in this step.

2. **Create GigaSMART operations using the GigaSMART Operations page (select GigaSMART > GigaSMART Operations (GSOP))**

Give your GigaSMART operation a name, include a valid combination of GigaSMART operations, and assign it to one of the GigaSMART groups created in the previous step.

Refer to [How to Combine GigaSMART Operations](#) for details on supported combinations of GigaSMART operations.

You can also configure how (or, in some cases, whether) a GigaSMART operation attaches a trailer that indicates where a packet arrived in the Gigamon Visibility Platform and how it was modified. This trailer can be interpreted using a recent version of the Wireshark[®] Protocol Analyzer. Refer to [GigaSMART Trailer Reference](#) for details on the GigaSMART Trailer.

3. **Apply GigaSMART operations to network ports in maps**

The New Map and Edit Map pages contain a **GigaSMART Operations (GSOP)** field that lets you select a GigaSMART operation to be used in a map. Refer to [Manage Maps](#) for details. Keep in mind, however, that GigaSMART operations **must** be selected before destination tool ports or collector destinations.

How to Use GigaSMART Operations – Example

To access GigaSMART within GigaVUE-FM, access a device that has been added to GigaVUE-FM from the GigaVUE-FM interface. GigaSMART appears in the navigation pane of the device view on supported devices. Refer to [Access GigaSMART from GigaVUE-FM](#) for details.

The following procedure summarizes the major steps in creating and using a GigaSMART operation.

1. From the device view, start by selecting **GigaSMART > GigaSMART Groups > GigaSMART Groups** and clicking **New** to create a **GigaSMART group** – a collection of one or more internal GigaSMART ports available in a given chassis. GigaSMART groups are used to process GigaSMART operations – each GSOP you create is assigned to a GigaSMART group.

In this example, a GigaSMART group called **GS1** is created that uses virtual port **e1** on the GigaSMART-HD0 line card in slot 2 of box 16 (**16/2/e1**):

On the GigaSMART Group configuration page:

- a. Enter GS1 in the **Alias** field.
- b. Click in the **Port List** field to select the port.

On the GigaSMART Group configuration page, you can also set parameters for specific types of GigaSMART operations.

- c. Click **Save**.

2. Next, you can create a **GigaSMART operation** – a combination of packet modification actions that can be used in a map – and assign it to a GigaSMART group for processing.

In this example, a GigaSMART operation called **tcpmask** is created that will overwrite 16 bytes of packet data starting 64 bytes after the end of the TCP header using a hexadecimal **ee** pattern. The GigaSMART operation is assigned to the **GS1** GigaSMART group created in the first step.

To create a GigaSMART operation called **tcpmask**:

- a. From the device view, select **GigaSMART > GigaSMART Operations**, and then click **New**.
- b. In the **Alias** field, enter **tcpmask**.
- c. Click in the **GigaSMART Groups** field and select **GS1** from the list of GigaSMART groups.

- d. Click in the **GigaSMART Operations (GSOP)** field and select **Masking** from the list. The configuration dialog for Masking displays.
- e. Configure Masking as follows:
 - **Protocol:** TCP
 - **Offset:** 64
 - **Pattern:** ee
 - **Length:** 16

3. Once you have set up a GigaSMART operation, you can include it as part of a map with the **GigaSMART Operations (GSOP)** field in the Map configuration page. In this example, the **tcpmask** GigaSMART operation is combined with an IP Version pass rule so that all IPv4 traffic processed is masked according to the GSOP created in the previous step.

If you are not sure which GigaSMART operation you want to use, click in the GSOP field to display a list of the operations you have already configured.

To configure the map:

- a. Select **Maps > Maps > Maps**, and then click **New** to open the New Map page.
- b. On the New Map page, configure the map as follows:
 - **Alias:** gsmmap
 - **Type:** Regular
 - **Subtype:** By Rule
 - **Source:** select the network ports (for example: 16/3/x7, 16/3/x8, 16/3/x9, 16/3/x10, 16/3/x11, 16/3/x12)
 - **Destination:** select the tool port (for example: 16/3/x1)
 - **GigaSMART Operations (GSOP):** tcpmasking (GS1)
- c. Click **Add Rule** and specify the following for the rule:
 - Select **Pass**
 - Click in the **Rule** field and select **IP Version**
 - Select **v4** for **Version**.
- d. Click **Save**.

Here, a map named **gsmmap** is created that forwards IPv4 traffic from network ports 16/3/x7..x12 to tool port 16/3/x1. The traffic will be masked using the **tcpmask** GigaSMART operation created in Step 2.

Groups of GigaSMART Engine Ports

To access GigaSMART within GigaVUE-FM, access a device that has been added to GigaVUE-FM from the GigaVUE-FM interface. GigaSMART appears in the navigation pane of the device view on supported devices. Refer to [Access GigaSMART from GigaVUE-FM](#) for details.

Use the GigaSMART Group page to create groups of GigaSMART engine ports in a given GigaVUE chassis. (To go to the GigaSMART Group page, select **GigaSMART > GigaSMART Groups > GigaSMART Groups > New.**)

The GigaSMART engine ports in a GigaSMART group can be on different line cards or modules in the same GigaVUE-HC2, or GigaVUE-HC3 chassis. However, all GigaSMART engine ports must be on the same chassis.

Use groups of GigaSMART engine ports to increase the processing power of GigaSMART. The processing power of the GigaSMART engine ports is as follows:

- Each of the two GigaSMART engine ports in an SMT-HC3-C05 module on GigaVUE-HC3 can process packets at up to **100Gb**.
- The GigaSMART engine port in a GigaSMART-HC0 module on GigaVUE-HC2 can process packets at up to **40Gb**.
- The GigaSMART engine port in the GigaVUE-HC1 node can process packets at up to **20Gb**.
- The GigaSMART engine port in the GigaVUE-HB1 node can process packets at up to **10Gb**.

The number of GigaSMART engine ports are as follows:

- Each GigaSMART-HC0 module includes one GigaSMART engine port.
- Each SMT-HC3-C05 module on GigaVUE-HC3 includes two GigaSMART engine ports.
- The GigaVUE-HC1 node includes one GigaSMART engine port.

The number of GigaSMART engine ports available in a chassis depends on the number of GigaSMART line cards or modules in the chassis as follows:

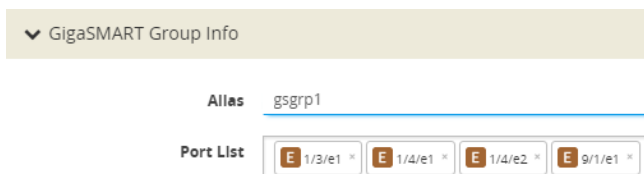
- Up to five modules in the GigaVUE-HC2 (four front GigaSMART modules and one rear GigaSMART module with one GigaSMART engine each, for a total of five).
- Up to four modules in the GigaVUE-HC3 (eight GigaSMART engine ports).

The following table provides a summary:

GigaVUE Node	Maximum GigaSMART Line Cards or Modules per Node	Number of GigaSMART engine ports per Line Card or Module	Maximum Number of GigaSMART engine ports in a GigaSMART group (gsgroup)
GigaVUE-HC3	4	2	8
GigaVUE-HC2	4 front, 1 rear	1	5
GigaVUE-HC1	1	1	1

Engine grouping for GTP is a special case, which is described in [GTP Engine Grouping](#).

GigaSMART engine ports are numbered with an **e** prefix using **<bid/sid/e1..e2>** nomenclature, such as 1/1/e1. For example:



Engine Watchdog Timer in GigaSMART

In rare scenarios, a packet processing core in the CPU of a GigaSMART engine can enter a deadlocked state. The engine watchdog timer detects the issue and reloads the GigaSMART engine after a specified number of seconds. The engine watchdog timer is enabled by default with a value of 60 seconds. The maximum number of seconds is 600 seconds.

NOTE: If a core is in a deadlocked state, all packets are dropped.

To access GigaSMART within GigaVUE-FM, access a device that has been added to GigaVUE-FM from the GigaVUE-FM interface. GigaSMART appears in the navigation pane of the device view on supported devices. Refer to [Access GigaSMART from GigaVUE-FM](#) for details.

To configure the engine watchdog timer, do the following:

1. From the device view, select **GigaSMART > GigaSMART Groups > GigaSMART Groups**.
2. If you are modifying an existing GigaSMART Group, select the GS Group and click **Edit**. Otherwise, click **New**.
3. In the **Alias** field, enter an alias for this GS Group.
4. In **Port List** field, select the engine port for this GS Group.

5. Under **Engine Timer**, do the following:
 - a. Select **Enable** to enable the time or clear the checkbox to disable the timer.
 - b. In the **Engine Watchdog Time field**, set the number of seconds to wait before reloading the engine. The minimum is 60. The maximum is 600.

In the following example, the timer is enabled and set to 100 seconds.

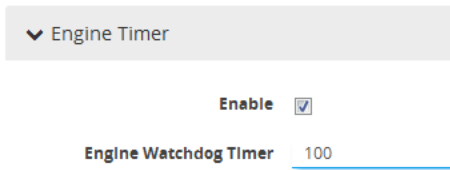


Figure 505: Engine Watchdog Timer

Tunnel Health Checks

Starting in software version 5.3, there are tunnel health checks. The reachability of IP destinations is checked and, if the destinations are not reachable, packets will not be sent or will stop being sent.

The tunnel health check on the GigaSMART card defines destinations as follows:

- IP destinations used for sending packets from a single IP interface with tool port to a single IP destination
- tunnel endpoints used for load balancing from a single IP interface with tool port to multiple IP destinations

An SNMP notification can be sent when the status of a IP destination or tunnel endpoint changes, either from Up to Down or from Down to Up.

To enable the SNMP notification, refer to [Enable or Disable Events for SNMP Notifications](#).

To configure ICMP health check parameters for the GigaSMART group, refer to [Figure 506: Configure ICMP Health Check Parameters](#).

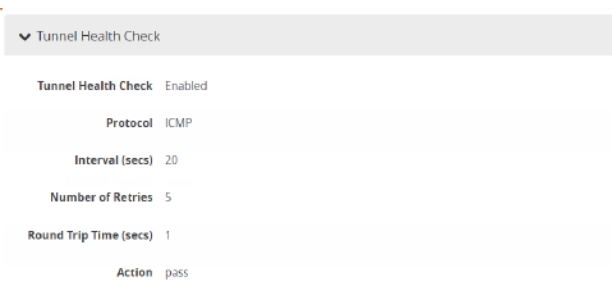


Figure 506: Configure ICMP Health Check Parameters

To configure UDP health check parameters for the GigaSMART group, refer to [Figure 507: Configure UDP Health Check Parameters](#).

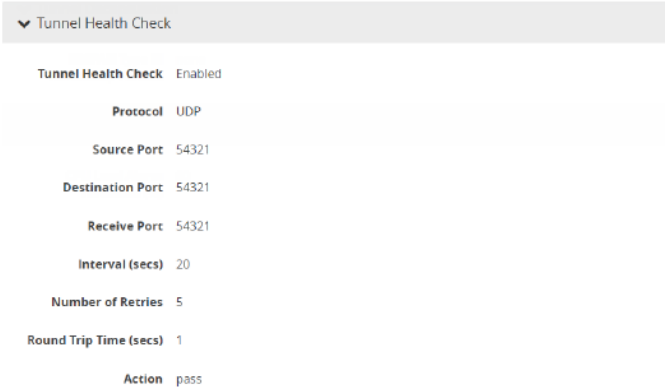


Figure 507: Configure UDP Health Check Parameters

To view IP interface status, refer to [Figure 508: View IP Destination Status](#).

<input type="checkbox"/>	Alias	Port	Status	Type	IP Address	IP Mask	Gateway	MTU	Hardware Address	GS Groups	Exporters	Comment
<input type="checkbox"/>	giga_auto_tunn...	3/4/x12	● Port is Healthy	IPv4	10.115.32.98	255.255.248.0	10.115.32.1	1500	00:1D:AC:7C:06:47	1 GS Group		Auto generated IP interface for...
<input type="checkbox"/>	giga_auto_tunn...	3/4/x14	● Port is Healthy	IPv4	10.115.32.195	255.255.248.0	10.115.32.1	1500	00:1D:AC:7C:06:49	1 GS Group		Auto generated IP interface for...
<input type="checkbox"/>	giga_auto_tunn...	3/4/x13	● Port is Healthy	IPv4	10.115.32.194	255.255.248.0	10.115.32.1	1500	00:1D:AC:7C:06:48	1 GS Group		Auto generated IP interface for...
<input type="checkbox"/>	giga_auto_tunn...	3/4/x16	● Port is Healthy	IPv4	10.115.32.193	255.255.248.0	10.115.32.1	1500	00:1D:AC:7C:06:4B	1 GS Group		Auto generated IP interface for...
<input type="checkbox"/>	giga_auto_tunn...	3/4/x15	● Component(s) cluster_gs_group ports are ...	IPv4	10.115.32.197	255.255.248.0	10.115.32.1	1500	00:1D:AC:7C:06:4A	1 GS Group		Auto generated IP interface for...

Figure 508: View IP Destination Status

To view tunnel endpoint status, refer to [Figure 509: View Tunnel Endpoint Status](#).

<input type="checkbox"/>	Tunnel Endpoint ID	Alias	IP Address	Status
<input type="checkbox"/>	te1		192.168.1.145	● Up
<input type="checkbox"/>	te2		192.168.1.188	● Down
<input type="checkbox"/>	te3		192.168.1.123	● Up
Total Items : 3				

Figure 509: View Tunnel Endpoint Status

To view IP interface statistics, refer to [Figure 510: View IP DestinationStatistics](#).

IP Interface	Bytes Rx	Bytes Tx	Packets Rx	Packets Tx	Multicast Packets Rx	Discards Rx	Discards Tx	Errors Rx	Errors Tx	Overruns Rx	Overruns Tx	Frame Rx	Carrier Tx	Collisions Tx
giga_auto_tunn...	109266444	176576	1707260	2759	0	0	0	0	0	0	0	0	0	0
giga_auto_tunn...	109266380	176576	1707259	2759	0	0	0	0	0	0	0	0	0	0
giga_auto_tunn...	0	640	0	10	0	0	0	0	0	0	0	0	0	0
giga_auto_tunn...	109272652	176640	1707357	2760	0	0	0	0	0	0	0	0	0	0
giga_auto_tunn...	109266636	176512	1707263	2758	0	0	0	0	0	0	0	0	0	0

Figure 510: View IP DestinationStatistics

To view GigaSMART operation statistics, refer to [Figure 511: View GigaSMART Operation Statistics](#).

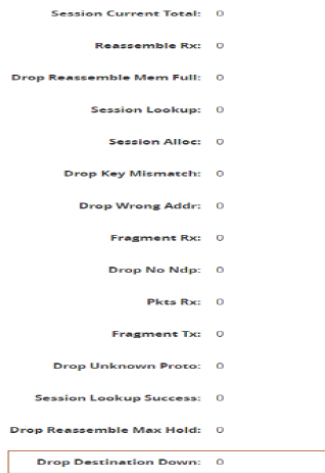


Figure 511: View GigaSMART Operation Statistics

Configure Hashing

The **Hash** option in the GigaSMART Group page allows you to select the required hashing option for the GigaSMART Groups. The following options are available:

- **Advanced:** Advanced hashing. Refer to the "Fabric Advanced Hashing" section in the *GigaVUE-OS and GigaVUE-FM Administration Guide*.
- **IPSrcIPDst:** Fixed two tuple hashing based on outer IP, Src and Dst.

GigaSMART Rules and Tips

When using GigaSMART operations, keep in mind the following rules and tips:

Note	Description
Use on Any GigaSMART-Enabled Node	<p>Maps including GigaSMART operations can be bound to any network port on a GigaSMART-enabled node:</p> <ul style="list-style-type: none"> • Standalone GigaVUE-HC3 with SMT-HC3-C05 module. • Standalone GigaVUE-HC2 with front or rear GigaSMART-HC0 module. • Standalone GigaVUE-HC1 nodes. • Standalone GigaVUE-HB1 nodes. • Any GigaVUE H Series node operating in a cluster with one of these node types. <p>Clustered nodes can use maps with GigaSMART operations so long as there is at least one node available in the cluster with GigaSMART capabilities. The GigaSMART group used to power the GigaSMART operation does not need to reside on the same physical chassis as the network or tool ports for the map. Refer to GigaSMART Operations in Clusters for some illustrations of how this works.</p>

Note	Description
Use in Maps with Standard Rule Criteria	<p>Combine GSOPs with map rules carefully to ensure selective application. For example, headers in an IPv4 packet end at a different offset than those in an IPv6 traffic. You can create maps for the following:</p> <ul style="list-style-type: none"> Identify IPv4 traffic, slice it at a 64-byte offset and forward the results to tool port 5. Identify IPv6 traffic, slice it at an 82-byte offset and forward the results to tool port 6. <p>GSOPs are applied to all packets matching any rule in the map in which the GSOP is included.</p>
Editing Maps and GSOPs	<p>Maps containing GigaSMART operations (GSOPs) should not be edited. Also GSOPs should not be edited once they are associated with maps.</p>
Rules for Tunneling Operations	<p>The rules for tunneling operations are as follows:</p> <ul style="list-style-type: none"> A map including a GigaSMART operation with a tunnel decapsulation component (tunnel-decap) cannot also include a collector rule. The system prevents situations that would violate this rule. GigaSMART operations with a tunnel decapsulation component can only be assigned to GigaSMART groups consisting of a single GigaSMART port. IP interfaces cannot be shared with map-passalls, tool-mirrors, port-pairs, or other regular maps. For devices involved in tunneling using GMIP, the recommendation is that they run the same software version on both sides of the tunnel (encapsulating/decapsulating).
Combine Multiple Components in a Single Operation	<p>You can combine multiple GigaSMART components into a single operation. For example, you could set up a single GigaSMART operation that masks a packet, strips its VLAN header, and applies a trailer.</p> <div data-bbox="516 1188 1455 1339" style="border: 1px solid #ccc; padding: 5px;"> <p>NOTE: With the exception of slicing and masking, most GigaSMART components can be combined in a single operation. Slicing and masking can be combined with other components but not with each other. Refer to How to Combine GigaSMART Operations for details on the combinations of GigaSMART operations.</p> </div> <div data-bbox="516 1352 1455 1440" style="border: 1px solid #ccc; padding: 5px;"> <p>NOTE: The [trailer <remove>] argument cannot be combined with others – it must be used by itself. Refer to Remove GigaSMART Trailers for details.</p> </div> <div data-bbox="516 1453 1455 1541" style="border: 1px solid #ccc; padding: 5px;"> <p>NOTE: NetFlow can only be combined with de-duplication and with APF (using second level maps).</p> </div>
GigaVUE-HC3 Nodes with Multiple GigaSMART Modules	<p>The GigaVUE-HC3 chassis supports up to four GigaSMART SMT-HC3-C05 modules. Each module has two GigaSMART engine ports. Each GigaSMART engine port can process packets at up to 100Gb.</p>

Virtual Ports

Virtual ports (vports) are used in flow maps to aggregate and redirect traffic to the GigaSMART ports. It is an aggregation point for traffic to be directed to the GigaSMART second level maps. Second level maps are used for configuring filtering rules enabled through GTP correlation and Adaptive Packet Filtering (APF).

To access GigaSMART within GigaVUE-FM, access a device that has been added to GigaVUE-FM from the GigaVUE-FM interface. GigaSMART appears in the navigation pane of the device view on supported devices. Refer to [Access GigaSMART from GigaVUE-FM](#) for details.

Create Virtual Port

To create a virtual port, use the following procedure:

1. From the device view, select **GigaSMART > Virtual Ports**.
2. Click **New**.
3. On the Virtual Ports page, do the following:
 - a. In the **Alias** field, enter a name for the virtual port. For example, gsTraffic.
 - b. From the GigaSMART Group drop-down list, select the GigaSMART group to associate with the virtual port. For example, gsgrp1.
 - c. Select the GTP Overlap check box to enable multiple GTP flow sampling maps to receive traffic from the same virtual port.
 - d. In the Inline Failover Action drop-down list, select one of the following options:
 - **Tool Bypass** — When the inline tool fails, all traffic coming to the respective inline tool is directed via the bypass path.
 - **Network Bypass** — When the inline tool fails, the traffic is directed to multiple inline tools associated with an inline network or inline network group using rule-based inline maps.
 - **Tool Drop** — When the inline tool fails, all traffic coming to the respective inline tool is dropped.
 - **Network Drop**—When the inline tool fails, all traffic coming to the respective inline tool is dropped.
 - **Network Port Forced Down**—When the inline tool fails, the inline network ports of the respective inline network are forced as "down".
 - e. Click **OK**.
4. Create a GigaSMART operation with an Adaptive Packet Filtering (APF) component.

- a. From the device view, select **GigaSMART > GigaSMART Operations (GSOP) > GigaSMART Operation**.
 - b. Click **New**.
 - c. In the **Alias** field, enter g1 for the GigaSMART Operation.
 - d. From the **GigaSMART Groups** list, select a GigaSMART group.
 - e. From the GigaSMART Operations (GSOP) list, select **Adaptive Packet Filtering**.
5. Create a first-level map name map1 to direct traffic to the virtual port gsTraffic.
- a. Go to the Maps page and click **New**. The New Map page opens.
 - b. Enter map1 in the **Alias** field.
 - c. For **Type**, select **First Level** and for **Subtype** select **By Rule** map
 - d. For **Source**, select a network port. For example, a network port with the alias N1.
 - e. For **Destination**, select the virtual port (gsTraffic).
 - f. Click Add a Rule, and create rule with the following conditions:
 - Pass
 - VLAN 20
 - IPv4 Protocol UDP
 - Port Destination 2152
 - g. Click **Save**.
6. Create second-level maps named map2 and map3 to direct traffic from the virtual port to the GigaSMART operation.

Configure the map map2 with the **Source** as virtual port gsTraffic, the **Destination** as port T1, and select g1 for **GigaSMART Operation (GSOP)**. For map2, add the following two rules.

Rule 1:

- Pass
- IPv4 Destination 65.128.7.21 Cidr 32
- IPv4 Protocol TCP
- Port Destination 80

Rule 2:

- Pass
- IPv4 Destination 98.43.132.70 Cidr 32
- IPv4 Protocol TCP
- Port Destination 80

Configure the map map3 with the **Source** as virtual port gsTraffic, the destination **Destination** as port T2, and g1 for **GigaSMART Operation (GSOP)** For map3, add the following two rules.

Rule 1:

- Pass
- IPv4 Destination 65.128.7.21 Cidr 32
- IPv4 Protocol TCP
- Port Destination 443

Rule 2:

- Pass
- IPv4 Destination 98.43.132.70 Cidr 32
- IPv4 Protocol TCP
- Port Destination 443

If there are other GigaSMART applications defined in the GigaSMART operation, filtering will be done on the packets before sending the GigaSMART applications.

7. Create a shared collector map name mapC1 to direct traffic not matching the second-level maps to the tool port with the alias T3. The collector for the first-level map named map1 uses the standard collector available in prior releases.
 - a. Go the Maps page and click **New**. The New Page page opens.
 - b. In the **Alias** field, enter mapC1.
 - c. For **Type**, select **Regular**.
 - d. For **Subtype**, select **Collector**.
 - e. For **Source**, select the virtual port gsTraffic.
 - f. For **Destination**, select the tool port with the alias T3, and the click **Save**.

Virtual Port Rules

The following rules apply to single virtual ports:

1. A given vport can only belong to one GigaSMART group.
2. Different first level maps with the same network ports can use the same vport. However, you must keep in mind the limitation described in Rule 1.
3. Different first level maps with different network ports can use the same vport. However, you must keep in mind the case described in Rule 2.
4. Different vports can be configured on the same GigaSMART group, but must be used in different maps.
5. A GigaSMART operation can only belong to one GigaSMART engine group.

6. In a first level map, you can specify a vport but not a GigaSMART operation.
7. The vport and the GigaSMART operation used in a second level map must be defined on the same GigaSMART group.
8. In a second level map, a maximum of 5 maps are allowed to be attached to a vport. The maximum number of gsrules in each map is 5. The maximum number of flowrules in each map is 32.

NOTE: Starting in software version 4.7, this limit is increased for GTP only. Refer to [GigaSMART GTP Whitelisting and GTP Flow Sampling](#). Starting in software version 5.2, this limit is increased for APF and ASF. Refer to [GigaSMART Adaptive Packet Filtering \(APF\)](#) and [GigaSMART Application Session Filtering \(ASF\) and Buffer ASF](#).

9. Multiple GTP flow sampling maps can receive traffic from the same virtual port when **GTP Overlap** is enabled.

Multiple Virtual Ports for First Level Map

A first level map can have multiple virtual ports (vports). When multiple vports are configured on a first level map, data is sent from network ports to the multiple vports destined to specific GigaSMART groups.

The tool ports of a first level map can be a combination of vports and tool ports. Each vport is bound to a GigaSMART group (gsgroup). Multiple vports are bound to multiple gsgroups. However, in a single first level map, all the vports must be bound to different gsgroups.

NOTE: For a second level map, only a single vport can be configured.

When a second level map is configured using a vport, the data that is sent to the gsgroup is forwarded to the tool ports according to the gsrules or flow rules configured on the map.

To access GigaSMART within GigaVUE-FM, access a device that has been added to GigaVUE-FM from the GigaVUE-FM interface. GigaSMART appears in the navigation pane of the device view on supported devices. Refer to [Access GigaSMART from GigaVUE-FM](#) for details.

To configure multiple vports for a first level map:

1. Create gsgroups on the GigaSMART engine, using the following steps to create a gsgroup with the alias gsgrp1 and one with the alias gsgroup2:
 - a. From the device view, select **GigaSMART > GigaSMART Groups > GigaSMART Groups**.
 - b. Click **New**.

- c. Enter an alias for the GigaSMART Group in the **Alias** field.
 - d. Click in the **Port List** field to select an engine port.
 - e. Enable parameters on the GigaSMART Group as needed. For example, to enable GTP correlation, enter the Timeout value under **GTP Flow**.
 - f. Click **Save**.
 - g. Repeat steps b through f to add another GigaSMART Group.
2. Enable GTP correlation on the GigaSMART groups.
 - a. From the device view, select **GigaSMART > GigaSMART Operations (GSOP) > GigaSMART Operation**.
 - b. Click **New**.
 - c. Enter a name for the GigaSMART Operation in the **Alias** field (for example gs1).
 - d. Select the GigaSMART groups from the **GigaSMART Groups** list.
 - e. Select **Flow Filtering** from the GigaSMART Operations (GSOP) list.
 - f. Click **Save**.
 - g. Repeat steps a through f to create the second GigaSMART Operation.
 3. Create vports (for example, vp1 and vp2) and assign them to the gsgroups. For the steps to create a virtual ports, refer to [Virtual Ports](#).
1. Create a **First Level By Rule** map and direct traffic to both vports and a tool port by navigating to the Maps page and clicking **New**.
 - a. Enter a name for the map in the **Alias** field. For example, map1.
 - b. Select **First Level** for **Type** and **By Rule** for **Subtype**.
 - c. Specify networks ports in the **Source** field.
 - d. Select the virtual ports and a tool port in the **Destination** field.
 - e. Click **Add Rule**.
 - f. Select **Pass** and **Port Destination** for ports 251 to 252.
 - g. Click **Save**.
 4. Create a second level map named to direct traffic from the first vport (vp1) to the GTP correlation GigaSMART operation by navigate to the Maps page and clicking **New**.
 - a. Enter a name for the map in the **Alias** field. For example, map2.

- b. Select **Second Level** for **Type** and **Flow Filtering** for **Subtype**.
 - c. Specify the first virtual port (vp1) in the **Source** field.
 - d. Select a tool port in the **Destination** field.
 - e. Click in the **GigaSMART Operation (GSOP)** field and select GSOP from the list. For example, gs1.
 - f. Click **Add Rule**.
 - g. Select **Pass** and **GTP IMSI**.
 - h. Enter 302720* in the IMSI field and select **Version V1**.
 - i. Click **Save**.
5. Create a shared collector map to direct traffic not matching the second level map to a tool port by navigating to the Maps page and clicking **New**.
 - a. Enter a name for the map in the **Alias** field. For example, sc1.
 - b. Select **Second Level** for **Type** and **Collector** for **Subtype**.
 - c. Select the first virtual port (vp1) in the **Source** field.
 - d. Select a tool port in the **Destination** field.
6. Create a second level map named **map3** to direct traffic from the second vport (vp2) to the GTP correlation GigaSMART operation by navigating to the Maps page and clicking **New**.
 - a. Enter a name for the map in the **Alias** field. For example, map3.
 - b. Select **Second Level** for **Type** and **Flow Filtering** for **Subtype**.
 - c. Specify the second virtual port (vp2) in the **Source** field.
 - d. Select a tool port in the **Destination** field.
 - e. Click in the **GigaSMART Operation (GSOP)** field and select GSOP from the list. For example, gs2.
 - f. Click **Add Rule**.
 - g. Select **Pass** and **GTP IMSI**.
 - h. Enter * in the IMSI field.
 - i. Click **Save**.

Multiple Virtual Port Rules

The following rules apply to multiple virtual ports for first level maps:

1. Multiple vports with different GigaSMART groups (gsgroups) can be used on a first level map.
2. Different vports can be configured on the same GigaSMART group, but must be used in different maps.
3. A gsgroup can have multiple GigaSMART operations (gsops).
4. Only one vport is allowed on egress (second level) maps.
5. A vport on a first level map cannot be edited. To make a map change, delete the vport from the **Destination** field first and then add a new vport by clicking in the **Destination** field and selecting another vport.
6. In a standalone system, the number of vports for a first level map is limited by the number of GigaSMART engines (eports) in the chassis.
7. In a cluster environment, the number of vports for a first level map is limited by the number of eports in the cluster.

Multiple Virtual Port with Other GigaSMART Applications

The example in [Multiple Virtual Ports for First Level Map](#) uses the GTP correlation GigaSMART operation. You can also use multiple vports with other GigaSMART operations, such as Adaptive Packet Filtering (APF). You can also chain multiple GigaSMART applications. This allows you to perform different functions and filtering with the same packets.

To access GigaSMART within GigaVUE-FM, access a device that has been added to GigaVUE-FM from the GigaVUE-FM interface. GigaSMART appears in the navigation pane of the device view on supported devices. Refer to [Access GigaSMART from GigaVUE-FM](#) for details.

To configure multiple vports for a first level map:

1. Create GigaSMART Groups on the GigaSMART engines, using the following steps to create three gsgroups with the aliases gg2, gg3, and gg5 and associate with gsops gs2, gs3, and gs5, respectively.
 - a. From the device view, select **GigaSMART > GigaSMART Groups > GigaSMART Groups**.
 - b. Click **New**.
 - c. Enter an alias for the GigaSMART Group in the **Alias** field. (In this example, gg2, gg3, or gg5.)
 - d. Click in the **Port List** field to select an engine port.

- e. Enable parameters on the GigaSMART Group as needed. For example, to enable GTP correlation, enter the Timeout value under **GTP Flow**.
 - f. Click **Save**.
 - g. Repeat steps b through f to add another GigaSMART Group.
2. Enable APF on the GigaSMART groups, using the following steps:
 - a. From the device view, select **GigaSMART > GigaSMART Operations (GSOP) > GigaSMART Operation**.
 - b. Click **New**.
 - c. Enter an alias for the GigaSMART Operation in the **Alias** field. (In this example, gs2, gs3, or gs5.)
 - d. Select the GigaSMART group from the **GigaSMART Groups** list. (For gs2, select gg2. For gs3, select gg3. For gs5, select gg3.)
 - e. Select **APF** from the GigaSMART Operations (GSOP) list and select **Enable**.
 - f. Select **Slicing** from the GigaSMART Operations (GSOP) list, and then set **Protocol** to none. For gs2 set the **offset** to 80. For gs3, set the **offset** to 90. For gs5, set the **offset** to 100.
 - g. Click **Save**.
 - h. Repeat steps a through f to create another GigaSMART Operation.
3. Create vports and assign them to the GigaSMART Groups, using the following steps to create three virtual ports named vp2, vp3, and vp4, assigning them to gsgroup gg2, gg3, and gg5 respectively.
 - a. From the device view, select **GigaSMART > Virtual Ports**.
 - b. Click **New**.
 - c. Enter an alias for the virtual in the **Alias** field. (In this example, vp2, vp3, or vp5.)
 - d. Select the gsgroup from the **GigaSMART Group** field (gg2 for vp2, gg3 for vp2, and gg5 for vp5).
 - e. Click **Save**.
 - f. Repeat step b through step e to create another virtual port.
4. Create a first level map, and direct traffic to two vports and a tool port, using the following steps:
 - a. Select **Maps > Maps > Maps**.

- b. Click **New**.
 - c. Enter m1 in the **Alias** field.
 - d. Select **First Level** for **Type** and **By Rule** for **Subtype**.
 - e. Select a network port in the **Source** field.
 - f. Select virtual ports vp2 and vp3 plus a tool port in the **Destination** field.
 - g. Use the **Add a Rule** button to add two rules to the map.
For the first rule, select **pass** and select **VLAN** for the condition. Set the VLAN value to 100.
For the second rule, select **pass** and select **VLAN** for the condition. Set the VLAN value to 200.
 - h. Click **Save**.
5. Create a second level map named to direct traffic from the vports to the GigaSMART operation, using the following steps:
 - a. Select **Maps > Maps > Maps**.
 - b. Click **New**.
 - c. Enter m2 in the **Alias** field.
 - d. Select **Second Level** for **Type** and **By Rule** for **Subtype**.
 - e. Select a virtual port vp2 the **Source** field.
 - f. Select a tool port in the **Destination** field.
 - g. Select gs2 for **GigaSMART Operation (GSOP)**.
 - h. Use the **Add a Rule** button to add a rules to the map.
For the rule, select **pass** and select **VLAN** for the condition. Set the VLAN value to 100 with **Subset** set to none and **Position** set to 0.
 - i. Click **Save**.
6. Create another second level map named to direct traffic from the vports to the GigaSMART operation, using the following steps:
 - a. Select **Maps > Maps > Maps**.
 - b. Click **New**.
 - c. Enter m4 in the **Alias** field.
 - d. Select **Second Level** for **Type** and **By Rule** for **Subtype**.

- e. Select a virtual port vp3 in the **Source** field.
 - f. Select a tool port in the **Destination** field.
 - g. Select gs3 for **GigaSMART Operation (GSOP)**.
 - h. Use the **Add a Rule** button to add a rules to the map.
For the rule, select **pass** and select **VLAN** for the condition. Set the VLAN value to 200 with **Subset** set to none and **Position** set to 0.
 - i. Click **Save**.
7. Create another second level map to direct traffic from the vports to the GigaSMART operation.
 - a. Select **Maps > Maps > Maps**.
 - b. Click **New**.
 - c. Enter m6 in the **Alias** field.
 - d. Select **Second Level** for **Type** and **By Rule** for **Subtype**.
 - e. Select a virtual port vp3 in the **Source** field.
 - f. Select a tool port in the **Destination** field.
 - g. Select gs3 for **GigaSMART Operation (GSOP)**.
 - h. Use the **Add a Rule** button to add a rules to the map.
For the rule, select **pass** and select **VLAN** for the condition. Set the VLAN value to 200 with **Subset** set to none and **Position** set to 0.
 - i. Click **Save**.
 8. Create a shared collector map named to direct traffic not matching the maps to a tool port.
 - a. Select **Maps > Maps > Maps**.
 - b. Click **New**.
 - c. Enter sc1 in the **Alias** field.
 - d. Select **Second Level** for **Type** and **Collector** for **Subtype**.
 - e. Select a virtual port vp1 in the **Source** field.
 - f. Select a tool port in the **Destination** field.
 - g. Click **Save**.

Virtual Port Statistics

The Virtual Ports page displays statistics about the configured virtual ports. To view the statistics select **GigaSMART > Virtual Ports > Statistics**.

The following table describes virtual port statistics:

Statistic	Description
Rx Packets	The number of packets received into the virtual port.
Tx Packets	The number of packets transmitted out of the virtual port.
Rx Octets	The number of bytes received into the virtual port.
Tx Octets	The number of bytes transmitted out of the virtual port.
Packets Drops	The number of packets dropped at the virtual port.
Packet Drops No Init	For internal debugging.

Differences in GigaSMART Nomenclature Between the CLI and H-VUE

The CLI and the Web-based H-VUE interface occasionally use different names to refer to the same GigaSMART-related functionality. The following table summarizes the differences:

Documentation Term	CLI Term	H-VUE Term	Description
GigaSMART Port	e1, e2	GigaSMART Engine	Internal ports on GigaSMART line card, module, or GigaVUE-HB1 node used to power GigaSMART features.
GigaSMART Group	gsgroup	GigaSMART Engine Group	Group of internal ports on GigaSMART line card, module, or GigaVUE-HB1 node used to power GigaSMART features. You configure these in the CLI with the gsgroup command.
GigaSMART Component	gsop	GigaSMART Operation	One of the available GigaSMART packet processing features (deduplication, slicing, and so on)
GigaSMART Operation	gsop	GigaSMART Operation Group	A combination of GigaSMART packet-processing features into a single entity used in a map. You configure these in the CLI with the gsop command.

GigaSMART Operations in Clusters

Clustered environments with at least one GigaSMART-enabled chassis can take advantage of GigaSMART operations in maps on network ports elsewhere in the cluster. As shown in [Figure 512: GigaSMART Group on Different Chassis than Network/Tool Ports](#) and [Figure 513: GigaSMART Operations in Clusters](#), the GigaSMART group providing the packet processing power for a GigaSMART operation does not have to be on the same chassis as the network or tool ports for a map.

- A map's network ports, tool ports, and the GigaSMART group ports can all be on different nodes in a clustered environment.
- GigaSMART operations do not require any specific role for the chassis with the GigaSMART group – it can be a master, standby, or normal node.
- The main requirements to keep in mind is that the GigaSMART ports in a GigaSMART group must all be on the same chassis. So, for example, if you had two GigaSMART-HD0 line cards in a single chassis, you could create a single GigaSMART group out of the four GigaSMART engine ports available across the two line cards. However, if the two line cards were in two different chassis, they could not be combined into a single GigaSMART group.

[Figure 512: GigaSMART Group on Different Chassis than Network/Tool Ports](#) and [Figure 513: GigaSMART Operations in Clusters](#) illustrate examples of network, tool, and GigaSMART group ports on different nodes in a clustered environment. For example, [Figure 512: GigaSMART Group on Different Chassis than Network/Tool Ports](#) shows a map accepting ingress packets on GV1, sending them to the GigaSMART group on GV3 for GigaSMART processing (for example, de-duplication), and sending the results to a tool port on GV4.

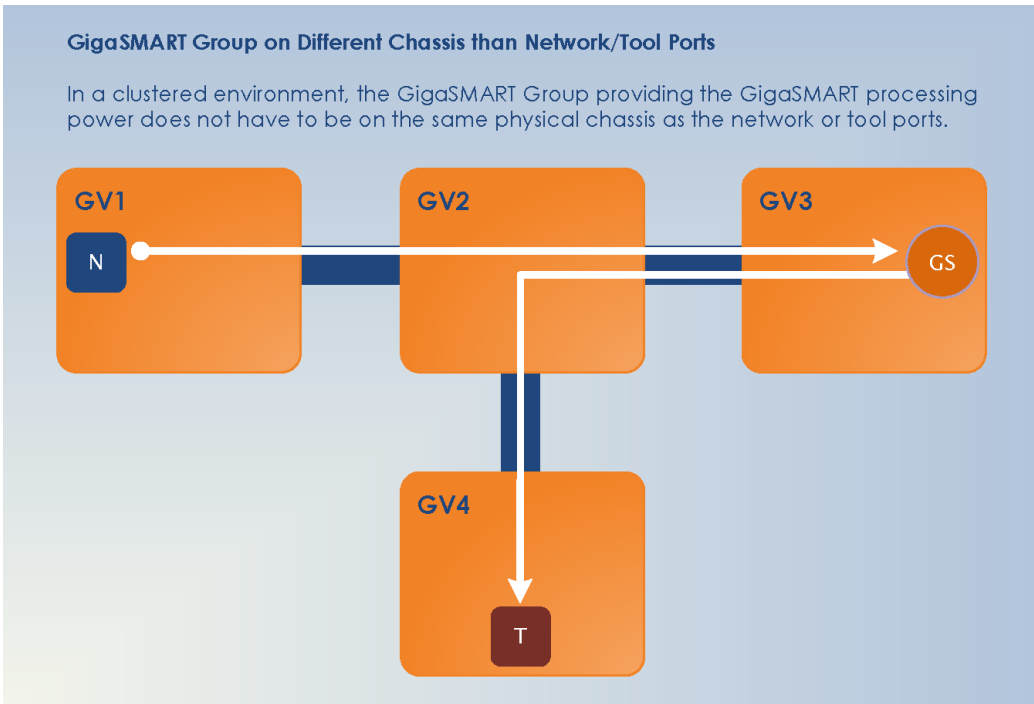


Figure 512: GigaSMART Group on Different Chassis than Network/Tool Ports

You could also have the GigaSMART group on the same chassis as either the network or tool ports for the map. An example of this is shown in [Figure 513: GigaSMART Operations in Clusters](#). The GigaSMART group on GV3 is on the same chassis as the egress port.

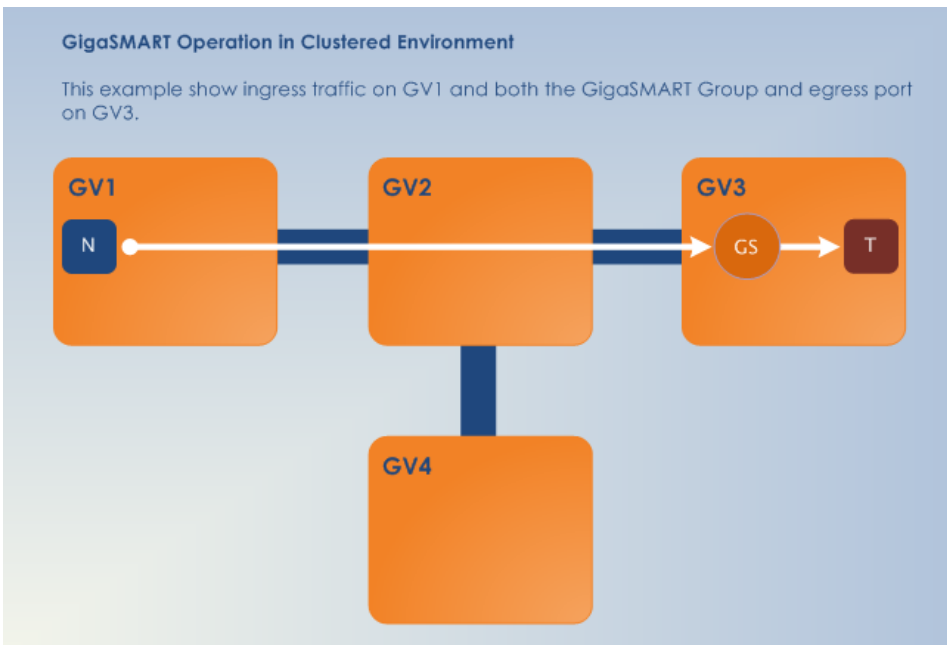


Figure 513: GigaSMART Operations in Clusters

How to Combine GigaSMART Operations

You can combine multiple GigaSMART components into a single operation. For example, you can set up a single GigaSMART operation that masks a packet, strips its VLAN header, and inserts a field in the GigaSMART Trailer.

The following table summarizes the valid combinations of GigaSMART operations (an X in the table indicates an invalid combination).

	Slicing	Enhanced Slicing	Masking	Source ID	Header/Trailer Remove	Dedup	Tunnel Encap	Tunnel Decap	Strip Header	Add Header	Flow-Ops (FlowVUE)	Flow-Ops (Flow Filter GTP)	Flow-Ops (GTP Whitelist)	Flow-Ops (GTP Flow Sampling)	APF	ASF	Netflow (1st Level Maps)	Netflow (2nd Level Maps)	Load Balance	SSL Decryption	Inline SSL	Application Filtering Intelligence	Application Metadata Intelligence	
Slicing																								
Enhanced Slicing																								
Masking																								
Source ID (Add Trailer)																								
Header/Trailer Remove	X	X																						
Dedup																								
Tunnel Encap																								
Tunnel Decap					X		X																	
Strip Header																								
Add Header								X																
Flow-Ops (FlowVUE)							X	X																
Flow-Ops (Flow Filter GTP)			X	X	X	X	X	X	X	X	X													
Flow-Ops (GTP Whitelist)			X	X	X	X	X	X	X	X	X													
Flow-Ops (GTP Flow Sampling)			X	X	X	X	X	X	X	X	X	X												
APF					X		X																	
ASF					X		X																	
Netflow (1st Level Maps)	X	X	X	X	X		X	X	X	X	X	X	X	X	X	X								
Netflow (2nd Level Maps)	X	X	X	X	X		X	X	X	X	X	X	X	X	X	X								
Load Balance																			X	X				
SSL Decryption	X	X	X	X	X		X	X	X	X	X	X	X	X	X	X	X	X	X	X				
Inline SSL	X	X	X	X	X		X	X	X	X	X	X	X	X	X	X	X	X	X	X				
Application Filtering Intelligence	X	X	X	X	X		X	X	X	X	X	X	X	X	X	X	X	X	X	X				
Application Metadata Intelligence	X	X	X	X	X		X	X	X	X	X	X	X	X	X	X	X	X	X	X				

NOTE: Masking operations cannot be combined with slicing unless the offset of the slicing is after the offset of the masking.

How to Read GigaSMART Operations Table

The GigaSMART operations table is read both across and down. The following is an example of how to read the GigaSMART operations table:

1. Begin in the left-most column and select a GigaSMART operation, for example: Add Header.
2. Move to the right along the Add Header row. Add Header can be combined with Slicing or Masking, Source Id, Header/Trailer Remove, Dedup, Tunnel Decap, and Strip Header. It cannot be combined with Tunnel Encap.
3. Move to the right another square to the gray square at end of the Add Header row. This is the Add Header column.
4. Move down the Add Header column, below the gray square at the end of the Add Header row. Add Header can be combined with Flow-Ops (FlowVUE), APF, ASF, and Load Balance. It cannot be combined with Flow-Ops (Flow-Filter GTP), Flow-Ops (GTP Whitelist), Flow-Ops (GTP Flow Sampling), NetFlow (1st Level Maps), NetFlow (2nd Level Maps), SSL Decryption (for Out-of-Band Tools), Inline-SSL (SSL Decryption for Inline Tools), Flow-Ops (SIP Flow Sampling), or Flow-Ops (SIP Flow Whitelist).

Work with GigaSMART Operation Combinations in H-VUE

When combining GigaSMART operations in H-VUE, the drop down option in the GSOP screen will gray out if a set of combinations is invalid.

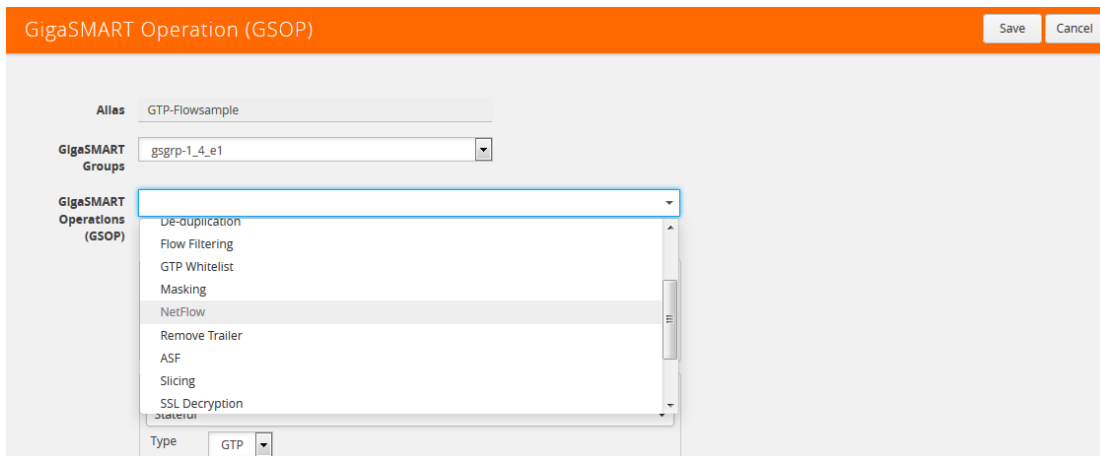


Figure 514: GigaSMART Operation Combinations Not Available

However, in the following cases, you may not see the combinations grayed out but when trying to save the combination a pop-up is displayed stating that the combination is invalid.

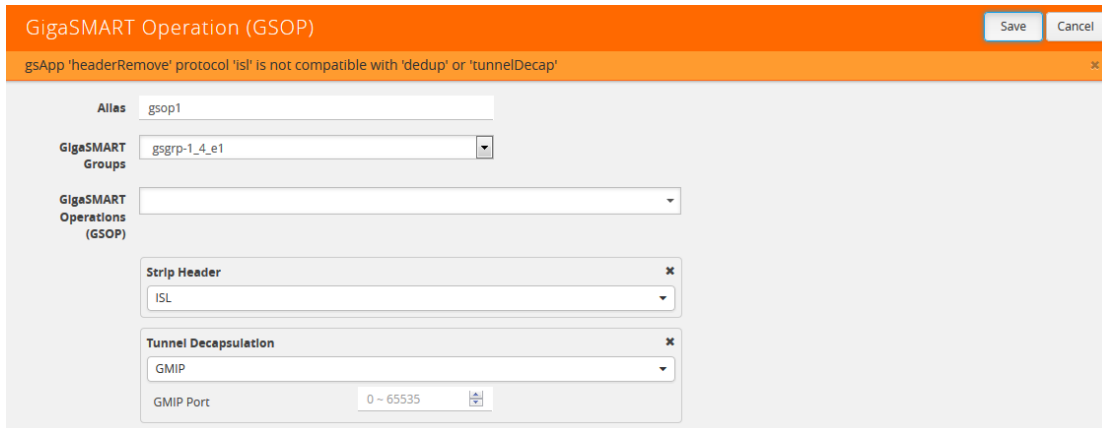


Figure 515: GigaSMART Operation Combinations Unable to Save

To get the valid combinations, refer to the table at the beginning of this section that summarizes the combinations.

Supported GigaSMART Operations

The following table lists the supported GigaSMART operations by GigaVUE node.

GigaSMART Operation	GigaVUE-HD4/ GigaVUE-HD8	GigaVUE-HC1	GigaVUE-HC2	GigaVUE-HC3	GigaVUE-HB1
Masking	✓	✓	✓	✓	✓
Slicing	✓	✓	✓	✓	✓
Enhanced Slicing	✗	✓	✓	✓	✗
Source ID (add Trailer)	✓	✓	✓	✓	✓
Header/Trailer Remove	✓	✓	✓	✓	✓
De-duplication	✓	✓	✓	✓	✓
Tunnel Encapsulation	✓	✓	✓	✓	✓
Tunnel Decapsulation	✓	✓	✓	✓	✓
Strip Header	✓	✓	✓	✓	✓
Add Header	✓	✓	✓	✓	✓
FlowVUE (IP-based)	✓	✓	✓	✓	✓

GigaSMART Operation	GigaVUE-HD4/ GigaVUE-HD8	GigaVUE-HC1	GigaVUE-HC2	GigaVUE-HC3	GigaVUE-HB1
GTP Flow Filtering	✓	✗	✓	✓	✗
GTP Whitelisting	✓	✗	✓	✓	✗
GTP Flow Sampling	✓	✗	✓	✓	✗
APF	✓	✓	✓	✓	✓
ASF	✓	✓	✓	✓	✓
AFI (Application Filtering Intelligence)	✗	✓	✓	✓	✗
AMI (Application Metadata Intelligence)	✗	✓	✓	✓	✗
NetFlow (1st Level Maps)	✓	✓	✓	✓	✓
NetFlow (2nd Level Maps)	✓	✓	✓	✓	✓
Load Balancing (Stateless)	✓	✓	✓	✓	✓
Load Balancing (Stateful)	✓	✓	✓	✓	✓
SSL Decryption for Out-of-Band Tools	✓	✓	✓	✓	✓
SSL Decryption for Inline Tools	✗	✗	✓	✓	✗
SIP Flow Sampling	✓	✗	✓	✓	✗
SIP Flow Whitelist	✓	✗	✓	✓	✗

NOTE: For GTP on GigaVUE-HB1, the following are not supported:

- GTP whitelisting in a cluster
- GTP engine grouping
- Access Point Name (APN)

Order of GigaSMART Operations

When combining multiple GigaSMART components into a single operation, the components are applied in the following order:

1. [apf/asf/buffer asf] OR [flow-ops <flow-filtering>] or [flow-ops <gtp-whitelist>] or [flow-ops <gtp-flowsampling>] AND [lb] (Stateful load balancing with GTP or ASF)
2. [tunnel-decap]
3. [dedup]
4. [ssl-decrypt]
5. [flow-ops <flow-sampling>]
6. [strip-header]
7. [slicing]
8. [enhanced slicing]
9. [masking]
10. [trailer]
11. [tunnel-encap]
12. [add-header]
13. [flow-ops <netflow>]
14. [lb] (Stateless load balancing)
15. [metadata-exporter]

View GigaSMART Statistics

To view the GigaSMART statistics from the UI, select **GigaSMART Operations (GSOP) > Statistics**.

The Statistics page displays as shown in [Figure 516: GigaSMART Operations Statistics Page](#).

GSOP Alias	GS Group Alias	Map Alias	Rx Packets	Tx Packets	Rx Octets	Tx Octets	Packet Drops	Packet Drops No Init	Packets Terminated	Packets Parse Errors	GS Operations
GigavueVM_Tunnel	gsgrp-1_4_e1	OpenStack_vTraffic_toWireshark	3.23 M	60	814.48 M	7.26 K	3.23 M	0	0	0	Tunnel Decap
gtp_flow_sampling_elias_test	gsgrp-1_4_e1	GTP-Sampling-2	0	0	0	0	0	0	0	0	Flow Sampling

Figure 516: GigaSMART Operations Statistics Page

The Statistics page shows the aliases for GS Operation, GS Group, the alias of the map that is using GS Operation, and the GS Operations being used. In [Figure 516: GigaSMART Operations Statistics](#)

[Page](#), Flow Sampling and Load Balance operations are assigned to the alias GTP-Flowsample in the gsggrp-1_4_e1 GS Group. The GS operations is used by the map with the alias map-gtpFS. For a description of the other columns, refer to [GigaSMART Operations Statistics Definitions](#).

Other statistics available for viewing from the UI are the following:

- GigaSMART Groups Statistics (select **GigaSMART > Statistics**)
- NetFlow / IPF Generation Statistics for Exporters and Monitors (select **NetFlow / IPFIX > Exporter Statistics or NetFlow / IPFIX Generation > Monitor Statistics**)
- IP Interface Statistics (select **Ports > IP Interfaces > Statistics**)

Definitions of GigaSMART Statistics

The following sections provide definitions for the statistics displayed. Refer to the following:

- [NetFlow Monitor Statistics Definitions](#)
- [NetFlow Exporter Statistics Definitions](#)
- [IP Interfaces Statistics Definitions](#)
- [GigaSMART Group Statistics Definitions](#)
- [GigaSMART Group Flow Ops Report Statistics Definitions](#)
- [GigaSMART Operations Statistics Definitions](#)

NetFlow Monitor Statistics Definitions

To view NetFlow Monitor statistics, select **GigaSMART > NetFlow / IPFIX Generation > Monitor Statistics** to open the Monitor Statistics page.

The following table describes NetFlow Monitor statistics displayed on the Monitor Statistics page:

Statistic	Description
No Entries	The current number of flows in the monitor cache.
High Watermark	The maximum number of flows that have ever been in the monitor cache.
Flows Added	The sum of all flows added to the monitor cache.
Flows Aged	The sum of the flows that have aged due to the following: <ul style="list-style-type: none"> • Active Timeout—The configured active timeout for the monitor cache was exceeded. • Inactive Timeout—The configured inactive timeout for the monitor cache was exceeded. • Event Aged—The number of entries aged from the cache because a TCP FIN/RST flag was received.

Statistic	Description
	<ul style="list-style-type: none"> Watermark Aged—The number of entries aged from the cache because the CPU utilization of the cache exceeded 75%. Emergency Aged—The number of entries aged from the cache because a user requested a forced flush through the CLI.
No of Active Timeout	The number of times the configured active timeout for the monitor cache was exceeded.
No of Inactive Timeout	The number of times the configured inactive timeout for the monitor cache was exceeded.
No of Event Aged	The number of entries aged from the cache because a TCP FIN/RST flag was received.
No of Watermarked Aged	The number of entries aged from the cache because the CPU utilization of the cache exceeded 75%.
No of Emergency Aged	The number of entries aged from the cache because a user requested a forced flush through the CLI.

NetFlow Exporter Statistics Definitions

To view NetFlow Exporter statistics, select **GigaSMART > NetFlow / IPFIX Generation > Monitor Statistics** to open the Exporter Statistics page.

The following table describes NetFlow Exporter statistics:

Statistic	Description
Templates Added	The number of data templates added to the exporter.
Records Added	The number of data records added to the exporter.
Filtered Records Removed	The number of records filtered by exporter filters
Empty Records Not Added	<p>The number of records not added to NetFlow because they were empty or blank.</p> <p>In the NetFlow record, if all the collect fields contain only enterprise extensions such as URL, HTTP, or DNS, and if during run-time, the records are blank or empty, they will be counted as Empty Records Not Added.</p>
Packets Sent	The number of packets sent from the exporter to the collector.
Packet Dropped	The number of packets dropped, which could be due to the inability to send packets, such as there is no network connection or the port is down.
Packet Transmit Errors	The number of packets dropped, which could be due to the inability to send packets, such as there is no network connection or the port is down.

IP Interfaces Statistics Definitions

To view IP Interfaces statistics, select **Ports > IP Interfaces > Statistics** to open the IP Interfaces Statistics page. The statistics of the control traffic such as ARP, ICMP, and ICMPv6 for the physical node will be displayed. [Figure 517: IP Interfaces Statistics](#) shows an example.

IP Interface	Bytes Rx	Bytes Tx	Packets Rx	Packets Tx	Multicast Packets Rx	Discards Rx	Discards Tx	Errors Rx	Errors Tx	Overruns Rx	Overruns Tx	Frame Rx	Carrier Tx	Collisions Tx
giga_auto_tunn...	109266444	176576	1707260	2759	0	0	0	0	0	0	0	0	0	0
giga_auto_tunn...	109266380	176576	1707259	2759	0	0	0	0	0	0	0	0	0	0
giga_auto_tunn...	0	640	0	10	0	0	0	0	0	0	0	0	0	0
giga_auto_tunn...	109272652	176640	1707357	2760	0	0	0	0	0	0	0	0	0	0
giga_auto_tunn...	109266636	176512	1707263	2758	0	0	0	0	0	0	0	0	0	0

Figure 517: IP Interfaces Statistics

The following table describes IP interfaces statistics:

Statistic	Description
IP Interface	The IP interface for which the statistics is displayed.
Bytes Rx	The number of bytes received into the IP interface.
Bytes Tx	The number of bytes transmitted out of the IP interface.
Packets Rx	The number of packets received into the IP interface.
Packets Tx	The number of packets transmitted out of the IP interface.
Multicast Packets Rx	The number of multicast packets received into the IP interface.
Discards Rx	The number of packets that were received and discarded by the IP interface.
Discards Tx	The number of packets that were transmitted out of the IP interface and were discarded.
Errors Rx	The number of packets with errors that were received into the IP interface.
Errors Tx	The number of packets with errors that were transmitted out of the IP interface.
Overruns Rx	The number of first-in-first-out (FIFO) buffer errors that were received into the IP interface.
Overruns Tx	The number of first-in-first-out (FIFO) buffer errors that were transmitted out of the IP interface.
Frame Rx	The number of frames received into the IP interface.
Carrier Tx	The number of packets in which carrier losses were detected when transmitted out of the IP interface.
Collisions Tx	The number of packets that were colliding when transmitted out of the IP interface.

SSL Application Statistics Definitions

The following table describes SSL application statistics:

Statistic	Description
active_sessions	The number of current active sessions.
num_session_ids_cached	The number of current session IDs that have been cached.
num_tls_tickets_cached	The number of current TLS tickets that have been cached.
total_sessions	The cumulative total number of sessions.
handshaked_sessions	The number of sessions that passed SSL handshake between a client and server to establish a session.
failed_sessions	The cumulative total number of failed sessions.
num_session_resumed_session_id	The total number of resumed sessions with a session ID.
num_session_resumed_ticket	The total number of resumed sessions with TLS tickets.
num_session_timedout	The number of SSL sessions that have timed out.
avg_in_pkts_per_session	The average number of input packets per session.
avg_out_pkts_per_session	The average number of output packets per session.

ASF Statistics Definitions

The following table describes ASF statistics:

Statistic	Description
Packet In	The number of packets received by the ASF application.
Session Created	The number of sessions created.
Session Freed	The number of sessions deleted.
Session Timeout	The number of sessions that were deleted due to inactivity (expiry of the session timer).
Packet Match Session	The number of incoming packets matching ASF sessions. This count does not include the packets that triggered the creation of the session.
Packets Buffered	The number of packets stored by buffer ASF prior to the APF match.
APF Match Pass	The number of packets matching a pass GigaSMART rule.
APF Match Drop	The number of packets matching a drop GigaSMART rule.

Statistic	Description
Packet Pass	The number of packets sent to tool ports due to a pass GigaSMART rule. (This includes packets belonging to pass sessions for ASF.)
Packet Drop	The number of packets dropped due to a drop GigaSMART rule. (This includes packets belonging to drop sessions for ASF.)
Packet No Match	The number of packets that did not match any GigaSMART rule. (This includes packets belonging to non-pass/drop sessions for ASF.)
Buffered Packet Pass	The number of buffered packets whose sessions matched a pass GigaSMART rule.
Buffered Packet Drop	The number of buffered packets whose sessions matched a drop GigaSMART rule.
Buffered Packet No Match	The number of buffered packets whose sessions did not match any GigaSMART rule.
Session Exceed Buffer Count	The number of sessions without an APF match after buffering that exceeded the configured buffer count.
Packet Exceed Buffer Count	The number of packets belonging to sessions that exceeded the configured buffer count.
Out of Buffer	The number of times GigaSMART ran out of packet buffer when trying to store a packet in a session.
Out of Session	The number of times GigaSMART ran out of session entries when trying to create a session.

GigaSMART Group Statistics Definitions

To view GigaSMART Group statistics, select **GigaSMART > GigaSMART Groups > Statistics** to open the Statistics page. [Figure 518: GigaSMART Group Statistics](#) shows an example.

<input type="checkbox"/>	GS Group Alias	Rx Packets	Tx Packets	Rx Octets	Tx Octets	Packet Drops	Packets Received Errors	Total Ports	Heartbeat Status	Heartbeat Rx Packets	Heartbeat Tx Packets
<input type="checkbox"/> >	gs_grp_hc3	0	0	0	0	0	0	1			

Figure 518: GigaSMART Group Statistics

The following table describes GigaSMART group statistics:

Statistic	Description
Rx Packets	The cumulative number of packets coming into a GigaSMART group.
Tx Packets	The cumulative number of packets going out of a GigaSMART group.
Rx Octets	The cumulative number of bytes coming into a GigaSMART group.

Statistic	Description
Tx Octets	The cumulative number of bytes going out of a GigaSMART group.
Packet Drops	The cumulative number of packets dropped at a GigaSMART group.
Packet Received Errors	The cumulative number of received packets with errors at a GigaSMART group.
Heartbeat Status of eport	<p>The status of heartbeat. The valid values are up, down, or NA. This heartbeat status is for a GigaSMART engine port on a GigaSMART group for inline SSL decryption</p> <p>On a supported platform, such as GigaVUE-HC2, the status will be either up or down, followed by number of packets sent and received. On an unsupported platform, the status will be NA and the number of packets will not be displayed.</p> <p>The heartbeat status for the GigaSMART cards is fully operational only when it is configured with the inline SSL application. In all other cases, the default value of the heartbeat status is Up and the status is generally ignored.</p>
Heartbeat Rx Packets	The heartbeat receive packet count.
Heartbeat Tx Packets	The heartbeat transmit packet count.

GigaSMART Group Flow Ops Report Statistics Definitions

The following sections provide definitions for the statistics that are reported for the GigaSMART group. Refer to the following:

- [Flow Ops Report Statistics Definitions for FlowVUE](#)
- [Flow Ops Report Statistics Definitions for GTP](#)
- [Flow Ops Report Statistics Definitions for GTP Overlap](#)
- [Flow Ops Report Definitions for SIP/RTP Correlation](#)
- [Flow Ops Report Definitions for Diameter S6a Correlation](#)
- [Flow Ops Report Statistics for Out-of-Band SSL Decryption](#)
-

Flow Ops Report Statistics Definitions for FlowVUE

The following table describes Flow Ops report statistics for FlowVUE:

Statistic	Description
Device IP	The IP address of the flow.
In Sample	The sample selected for pass (1) or drop (0).

Statistic	Description
Num Packets	The number of packets seen for the flow.
Num Octets	The sum of the packet lengths of all packets seen for the flow.
num_devices	The number of devices.
num_devices_in_sample	The number of devices in the sample.

Flow Ops Report Statistics Definitions for GTP

The following table describes Flow Ops report statistics for GTP, including GTP flow filtering, GTP whitelisting, and GTP flow sampling:

Statistic	Description
Tunnel[Ver]	The tunnel type (CTRL for control plane, USER for user data plane) and version (1 or 2).
Interface EBI:LBI[QCI]	The interface and Evolved Packet System (EPS) Bearer Identifier (EBI), Linked Bearer Identity (LBI), and QoS Class Identifier.
IP:Tunnel-ID ==> IP:Tunnel-ID	The IP addresses and tunnel identifiers of both sides of the tunnel. NOTE: For LTE nodes only, the IP addresses can be both IPv4 and IPv6.
IMSI	The International Mobile Subscriber Identity (IMSI) value.
APN	The Access Point Name (APN) value.
WL	The IMSI had a match in the whitelist (WL) or did not. The values are N for no and Y for yes.
FS	The IMSI was flow sampled or not. The values are A for accepted, R for rejected, and N for no match.
ID	The rule ID of the flow sample rule.
LB port	The load balancing port number.
Pkts	The number of packets.
Timestamp	The internal clock time of when the session was created.
GTP Resource Summary	
Num Sessions In Use	The number of correlated session in use.
Num Tunnels In Use	The number of used tunnels in the tunnel resource pool.
Tunnels Available	The number of available tunnels in the tunnel resource pool.

Statistic	Description
UPN CTunnels Available	The number of available tunnels in the UPN C tunnels resource pool.
Tunnels Pending Free	The number of tunnels marked free, ready to be returned to the tunnel resource pool.
Tunnels Marked Free	The number of times used tunnels are marked free.
Tunnels Returned	The number of times used tunnels are returned to the tunnel resource pool.
Current Time	The current time (in CPU cycles). Used for debugging.

Flow Filtering Report Summary

Control Tunnels	The total number control tunnels.
Control & User Tunnels	The total number of control and user tunnels.
GTP Session Stats	The interface type: Gn/Gp, S1U/S11, S5/S8, S3/S4, or Other.
Sessions	The number of sessions by interface. Note the following: <ul style="list-style-type: none"> • The counter for S3/S4 will always be 0 (not supported). • The S10 interface is counted under Other.
Tunnels	The number of tunnels by interface.
Pending Session	The number of sessions waiting for control message response.
Control Only Session	The number of sessions without user bearers.

Flow Sampling Report Summary

Total Devices	The total number devices in the flow sample
Number of Device in Sample	The number of devices used in each sample session

Flow SIP Report Summary

SIP Sessions	This graph displays the total sessions, total sessions in use and the number of parse errors.
RTP Sessions	This graph displays the total number of sessions and the total data pool in use.

GTP Interface Stats

For overlap maps, refer to the notes below the table for [Flow Ops Report Statistics Definitions for GTP Overlap](#)

Rx Pkts	The received (Rx) packets for GTP correlation statistics for GTP traffic by interface type: S11, S1u, S5S8 (control and user), Gn (control and
---------	--

Statistic	Description
	user), total (control and user), collector (control and user). NOTE: If traffic does not match any map rules, it will be sent to the collector.
Rx Bytes	The received (Rx) bytes for GTP correlation statistics for GTP traffic by interface type.
Sample/WL/Filter (Tx) Pkts	The transmitted (Tx) packets sampled in for flow sampling, whitelisting, and flow filtering by interface type. For example, if sampling is 60%, then 60% is sampled in.
Sample/WL/Filter (Tx) Bytes	The transmitted (Tx) bytes sampled in for flow sampling, whitelisting, and flow filtering by interface type.
Sample Out (Dropped) Pkts	The packets sampled out (dropped) by interface type. For example, if sampling is 60%, then 40% is sampled out.
Sample Out (Dropped) Bytes	The bytes sampled out (dropped) by interface type.
Xaui Drop	The total traffic (Rx bytes and packets) dropped due to oversubscription on the interface into the GigaSMART.

Statistics for Control Message (GTP-c)

GTPV1	The GTPv1 (version 1) message type.
Cre PDP Req	Create Packet Data Protocol (PDP) context request.
Cre PDP Rsp	Create PDP context response.
Upd PDP Req	Update PDP context request.
Upd PDP Rsp	Update PDP context response.
Del PDP Req	Delete PDP context request.
Del PDP Rsp	Delete PDP context response.
GTPV2	The GTPv2 (version 2) message type.
Cre Ssn Req	Create session request.
Cre Ssn Rsp	Create session response.
Mod Bea Req	Modify bearer request.
Mod Bea Rsp	Modify bearer response.
Del Ssn Req	Delete session request.
Del Ssn Rsp	Delete session response.

Statistic	Description
Cre Bea Req	Create bearer request.
Cre Bea Rsp	Create bearer response.
Upd Bea Req	Update bearer request.
Upd Bea Rsp	Update bearer response.
Del Bea Req	Delete bearer request.
Del Bea Rsp	Delete bearer response.
Mod Bea Cmd	Modify bearer command.
Mod Bea Fai	Modify bearer failure indication.
Bea Rsr Cmd	Bearer resource command.
Bea Rsr Fai	Bearer resource failure indication.

Message Counters

Tool Pass	The number of control messages passed to the tools.
Col NoSess	The number of control messages sent to the collector without matching sessions.
Col NoTnlx	The number of "out of tunnels" requests sent to the collector for the control message.
Col ParseEr	The number of control messages sent to the collector with unsupported options.
Col NoRule	The number of control messages sent to the collector without matching rules.
Col Other	The number of control messages sent to the collector with other conditions, for example, the message matched a drop rule.

Statistics for User Data Message (GTP-u)

Tool Pass	The number of user data messages passed to the tools.
Collector	The number of user data messages sent to the collector without matching sessions.
Drop	The number of user data messages dropped.

Flow Ops Report Statistics Definitions for GTP Overlap

The following table describes Flow Ops report statistics for GTP overlap flow sampling. Since most fields are the same as [Flow Ops Report Statistics Definitions for GTP on page 719](#), they are not repeated. Refer to the note below the table for GTP Interface Stats for overlap maps.

Statistic	Description
Tunnel[Ver]	The tunnel type (CTRL for control plane, USER for user data plane) and version (1 or 2).
Interface EBI:LBI[QCI]	The interface and Evolved Packet System (EPS) Bearer Identifier (EBI), Linked Bearer Identity (LBI), and QoS Class Identifier.
IP:Tunnel-ID ==> IP:Tunnel-ID	The IP addresses and tunnel identifiers of both sides of the tunnel.
IMSI	The International Mobile Subscriber Identity (IMSI) value.
APN	The Access Point Name (APN) value.
Overlap Result	The overlap result. A map group for GTP overlap flow sampling maps contains six maps. Each character in the result represents one of the maps. The result is in alphabetical order for each map within the map group. (There is no map priority.) Refer to the following legend: <ul style="list-style-type: none"> • A—Flow Sample Accept • R—Flow Sample Reject • W—Whitelist Accept • N—No Match
Pkts	The number of packets.
Timestamp	The internal clock time of when the session was created.

The following notes are for the combination of overlap and non-overlap maps:

- If at least one flow sample map accepts the packets among all the pairs of overlap maps, the Sample (Tx) counters in the GTP Interface Stats will be incremented. If more than one pair of maps accepts the packets the Sample (Tx) counters in the GTP Interface Stats will still be incremented only once.
- If at least one whitelist map matches the packets among all the pairs of overlap maps, the Sample (Tx) counters in the GTP Interface Stats will be incremented. If more than one pair of maps matches the packets the Sample (Tx) counters in the GTP Interface Stats will still be incremented only once.
- If there are no whitelist maps and all flow sample maps are no-rule-match, the Sample (Tx) and Sample Out counters in the GTP Interface Stats will not be incremented.

Flow Ops Report Definitions for SIP/RTP Correlation

The following table describes Flow Ops report statistics for SIP/RTP correlation.

Statistic	Description
PROTO	The protocol, such as SIP, RTP, or RTCP. NOTE: The RTCP port number is assumed to be the corresponding RTP port number plus 1. This results in even numbered RTP ports and odd numbered RTCP ports.
TRANSPORT	The transport layer, such as UDP or TCP.
METHOD	The SIP method (or SIP message).
CALLER: IP	The corresponding IP address of the caller.
CALLEE: IP	The corresponding IP address of the callee.
PDU	The number of packets seen for this session.
CALL-ID	The call identifier.
WL	The caller/callee ID had a match in the whitelist (WL) or did not. The values are N for no and Y for yes.
FS	The caller ID was flow sampled or not. The values are A for accepted, R for rejected, and N for no match.
ID	The rule ID
LB port	The load balancing port number, which is the port over which the session has been load balanced. All SIP and corresponding RTP packets will be sent to this port.
Timestamp	The internal clock time of when the session was created.
Message counters	
SIP messages	All the SIP messages that have been correlated, such as, ACK, BYE 200, CANCEL, INFO, and so on. These counters are cumulative
Tool Pass	The number of SIP messages passed to the tools
NoSess	The number of SIP messages sent to the collector without matching sessions
NoRule	The number of SIP messages sent to the collector without matching rules.
NoMatch	Reserved
Other	The number of SIP messages sent to the collector with other conditions.

Statistic	Description
SIP Resource Summary	
Num Sessions In Use	The number of SIP sessions.
Sessions Available	The number of remaining SIP sessions available. (This varies by GigaVUE node.)
RTP Resource Summary	
Num Data Pools In Use	The number of RTP sessions.
Data Pools Available	The number of remaining RTP sessions available. (This varies by GigaVUE node.)

Flow Ops Report Definitions for Diameter S6a Correlation

The following table describes the Flow Ops report statistics for diameter correlation.

Statistic	Description
User Name	The User name
Session ID	Session ID of the diameter session
Application ID	Application ID
LB Port	The load balancing port number, which is the port over which the session has been load balanced.
Pkts	The number of packets.
WL	The user name had a match in the whitelist (WL) or not. The values are: <ul style="list-style-type: none"> • N for No • Y for Yes.
FS	The user name was flow sampled or not. The values are: <ul style="list-style-type: none"> • A for accepted • R for rejected • N for no match
S6a	Diameter S6a messages that have been correlated successfully.
Tool Pass	The number of user data messages passed to the tools.
NoSession	The number of diameter messages sent to the collector without matching sessions

Statistic	Description
NoRule	The number of diameter messages sent to the collector without matching rules.
NoMatch	The number of unprocessed packets.
Drop	The number of packets in rejected section.
Other	The number of packets that didnot match the other criteria.

Flow Ops Report Statistics for Out-of-Band SSL Decryption

The following table describes Flow Ops report statistics for out-of-band SSL decryption:

Statistic	Description
Server IP	The IP address of the server.
Server Port	The port number of the server.
Client IP	The IP address of the client.
Client Port	The port number of the client.
Version	The version.
First Error	The first error encountered on a session. After the first error, subsequent packets are dropped. If a session encounters errors, the packets for that session are ignored. The session will be cleared after the session times out.
In Pkts	The number of packets going into the session.
Out Pkts	The number of packets transmitted out of the session.
num_total_sessions	The total number of out-of-band SSL decryption sessions.
num_ssl30_sessions	The cumulative total number of SSL 3.0 sessions.
num_tls10_sessions	The cumulative total number of TLS 1.0 sessions.
num_tls11_sessions	The cumulative total number of TLS 1.1 sessions.
num_tls12_sessions	The cumulative total number of TLS 1.2 sessions.
num_session_ids	The number of current session IDs.
num_tickets	The number of current TLS tickets.

GigaSMART Operations Statistics Definitions

To view GigaSMART Operations statistics, select **GigaSMART > GigaSMART Operations (GSOP) > Statistics** to open the Statistics page.

The following table describes the statistics that are common to all GigaSMART operations:

Statistic	Description
Pkts Drop	The cumulative number of packets dropped at a GigaSMART operation for a map.
Pkts Rx	The cumulative number of packets coming into a GigaSMART operation for a map.
Octets Rx	The cumulative number of bytes coming into a GigaSMART operation for a map.
Pkts Term	The cumulative number of packets of a terminated session of a GigaSMART operation for a map.
Octets Tx	The cumulative number of bytes going out of a GigaSMART operation for a map.
Pkts Tx	The cumulative number of packets going out of a GigaSMART operation for a map.
Pkts Drop No Init	For internal debugging.
Pkts Parse Err	The cumulative number of packets with invalid or unsupported header types of a GigaSMART operation for a map.

The following sections provide definitions for the statistics that are specific to a particular GigaSMART operation. Refer to the following:

- [Out-of-Band SSL Decryption Statistics Definitions](#)
- [Inline SSL Decryption Statistics Definitions](#)
- [De-duplication Statistics Definitions](#)
- [ERSPAN Statistics Definitions](#)
- [Tunnel Decapsulation Statistics Definitions](#)
- [Tunnel Encapsulation Statistics Definitions](#)
- [APF Statistics Definitions](#)
- [ASF Statistics Definitions](#)
- [Masking Statistics Definitions](#)
- [Slicing Statistics Definitions](#)
- [Header Stripping Statistics Definitions](#)
- [Generic Header Stripping Statistics Definitions](#)
- [Trailer Statistics Definitions](#)
- [FlowVUE Statistics Definitions](#)

- [NetFlow Statistics Definitions](#)

Out-of-Band SSL Decryption Statistics Definitions

The following table describes GigaSMART operations statistics for out-of-band SSL decryption:

Statistic	Description
Sessions Total	The cumulative total number of sessions.
Sessions Active	The number of currently active sessions.

Inline SSL Decryption Statistics Definitions

The statistics for inline SSL decryption are described in [Inline SSL Decryption](#).

De-duplication Statistics Definitions

The following table describes GigaSMART operations statistics for de-duplication (including the statistics that are displayed in a cluster environment):

Statistic	Description
Ip 6 Missed Op Busy	For IPv6 packets, the number of non-duplicate packets passed through without storing because the GigaSMART engine was too busy processing other packets. NOTE: Applies only to non-duplicate packets.
Non Ip Dupl	The number of non-IPv4 and non-IPv6 duplicate packets detected.
Non Ip	The number of non-IPv4 and non-IPv6 packets received for de-duplication.
Ip 6 Missed Op Space	For IPv6 packets, the number of non-duplicate packets passed through without storing because the GigaSMART engine did not have enough storage space. NOTE: Applies only to non-duplicate packets.
Non Ip Missed Op Busy	For non-IPv4 and non-IPv6 packets, the number of non-duplicate packets passed through without storing because the GigaSMART engine was too busy processing other packets. NOTE: Applies only to non-duplicate packets.
Non Ip Missed Op Space	For non-IPv4 and non-IPv6 packets, the number of non-duplicate packets passed through without storing because the GigaSMART engine did not have enough storage space.

Statistic	Description
	NOTE: Applies only to non-duplicate packets.
Ip 4 Missed Op Busy	For IPv4 packets, the number of non-duplicate packets passed through without storing because the GigaSMART engine was too busy processing other packets. NOTE: Applies only to non-duplicate packets.
Ip 4 Missed Op Space	For IPv4 packets, the number of non-duplicate packets passed through without storing because the GigaSMART engine did not have enough storage space. NOTE: Applies only to non-duplicate packets.
Ip 4 Ipid Tcp Rst	The number of TCP RESETs for IPv4 plus TCP packets. (IPv4 plus TCP RESET packets are not de-duplicated.)
Ip 6 Dupl	The number of IPv6 duplicate packets detected.
Ip 4 Dupl	The number of IPv4 duplicate packets detected.

ERSPAN Statistics Definitions

The following table describes GigaSMART operations statistics for ERSPAN tunnel:

Statistic	Description
Drop Type 3 Marker Bad Sig	The number of ERSPAN Type III packets that have a bad marker packet signature. The expected marker packet signature is 0xa5a5a5a5.
Pkts Too Big	The number of ERSPAN packets that are larger than 9600 bytes after the timestamp trailer is added. These packets will be dropped.
Pkts Rx Type 3	The total number of ERSPAN Type III packets received.
Pkts Tx Type 3 Marker	The total number of ERSPAN Type III marker packets received. (These packets are not forwarded.)
Pkts Rx Type 2	The total number of ERSPAN Type II packets received.
Type 3 Marker Overdue	The number of ERSPAN Type III marker packets that are overdue. Based on granularity, if a marker packet does not arrive by the time specified, it is considered overdue. Refer to ERSPAN Granularity .
pkts Rx	The total number of ERSPAN packets received into the IP interface.
Drop Unknown Proto	The number of packets dropped because they were not recognized as ERSPAN packets or ERSPAN marker packets.
Drop Id No Hit	The number of ERSPAN packets with a wrong flow ID/ERSPAN ID.

Tunnel Decapsulation Statistics Definitions

The following table describes GigaSMART operations statistics for tunnel decapsulation:

Statistic	Description
GMIP Tunnel	
Drop Wrong Addr	The number of GMIP tunneled packets dropped whose destination UDP port does not match the configured value.
Drop Other	The number of GMIP tunneled packets dropped because of fragmented packets.
Pkts Rx	The number of packets received into the IP interface.
Reassemble Rx Success	The number of incoming packets successfully reassembled.
Drop Unknown Proto	The number of packets through the network IP interface dropped if they are neither IPv4 or UDP packets.
Reassemble Rx	The number of incoming packets to be reassembled.
Drop Reassemble Mem Full	The number of packets not successfully reassembled and dropped due to lack of memory for reassembly.
Sliced Mtu	Not valid for tunnel decapsulation.
Drop Reassemble Max Hold	The number of packets not successfully reassembled and dropped due to the arrival of too many fragments not yet reassembled. The maximum fragment sessions are already held for reassembly.
Drop No Arp	The number of packets dropped because ARP was not resolved on the IP interface (in particular, on a tool IP interface).
Drop Reassemble Overlap Frag	The number of packets not successfully reassembled and dropped due to overlapping reassembly fragments.
L2GRE Tunnel	
Drop Key Mismatch	The number of packets dropped due to key mismatch.
Pkts Rx	The number of packets received into the IP interface.
Reassemble Rx Success	The number of incoming packets successfully reassembled.
Drop Unknown Proto	The number of packets dropped due to an unknown protocol.
Reassemble Rx	The number of incoming packets to be reassembled.
Drop Reassemble Mem Full	The number of packets not successfully reassembled and dropped due to lack of memory for reassembly.
Drop Reassemble Max Hold	The number of packets not successfully reassembled and

Statistic	Description
	dropped due to the arrival of too many fragments not yet reassembled. The maximum fragment sessions are already held for reassembly.
Drop Other	The number of packets dropped due to other reasons.
Drop Reassemble Overlap Frag	The number of packets not successfully reassembled and dropped due to overlapping reassembly fragments.

Tunnel Encapsulation Statistics Definitions

The following table describes GigaSMART operations statistics for tunnel encapsulation:

Statistic	Description
GMIP Encap Tunnel	
Fragment Rx	The number of incoming packets to be fragmented.
Drop Other	Not valid for tunnel encapsulation.
Pkts Rx	The number of packets received into the IP interface.
Fragment Tx	The number of outgoing packets sent to the tunnel after fragmentation.
Sliced Mtu	The number of packets that are sliced to the MTU size of the tool IP interface.
Drop No Arp	The number of packets dropped because ARP was not resolved on the IP interface (in particular, on a tool IP interface).
L2GRE Encap Tunnel	
Fragment Rx	The number of incoming packets to be fragmented.
Pkts Rx	The number of packets received into the IP interface.
Fragment Tx	The number of outgoing packets sent to the tunnel after fragmentation.
Session Current Total	The number of currently active sessions.
Session Alloc Fail	The number of session allocations that failed.
Session Lookup	The number of lookups in a session.
Session Lookup Success	The number of lookups in a session that were a success.
Session Alloc	The number of sessions allocated.
Session Timedout	The number of sessions that timed out after a configured timer value.
Sliced Mtu	The number of packets that are sliced to the MTU size of the tool IP interface.
Drop No Arp	The number of packets dropped because ARP was not resolved on the IP

Statistic	Description
	interface (in particular, on a tool IP interface).
CUSTOM Decap Tunnel	
rx_packets	The number of packets received into the IP interface.
pkts_drop_unknown_protocol	The number of packets dropped due to an unknown protocol.
pkts_drop_portsrc_mismatch	The number of packets dropped due to source port mismatch.
pkts_drop_portdst_mismatch	The number of packets dropped due to destination port mismatch.
pkts_in_reassemble	The number of incoming packets to be reassembled.
pkts_in_reassemble_success	The number of incoming packets successfully reassembled. For example, if four (4) packets are reassembled into one (1), 4 is displayed in this field.
pkts_out_reassembled	The actual number of packets sent out the tool port. For example, if four (4) packets are reassembled into one (1), 1 is displayed in this field.
pkts_drop_reassemble_overlap_frag	The number of packets not successfully reassembled and dropped due to overlapping reassembly fragments.
pkts_drop_reassemble_max_hold	The number of packets not successfully reassembled and dropped due to the arrival of too many fragments not yet reassembled. The maximum fragment sessions are already held for reassembly.
pkts_drop_reassemble_mem_full	The number of packets not successfully reassembled and dropped due to lack of memory for reassembly.
pkts_drop_reassemble_timed_out	The number of packets dropped due to timeout in the reassembly queue.
VXLAN Decap Tunnel	
rx_packets	The number of packets received into the IP interface.
pkts_drop_unknown_protocol	The number of packets dropped due to an unknown protocol.
pkts_drop_portsrc_mismatch	The number of packets dropped due to source port mismatch.
pkts_drop_portdst_mismatch	The number of packets dropped due to destination port mismatch.
pkts_in_reassemble	The number of incoming packets to be reassembled.
pkts_in_reassemble_success	The number of incoming packets successfully reassembled. For example, if four (4) packets are reassembled into one (1), 4 is displayed in this field.
pkts_out_reassembled	The actual number of packets sent out the tool port. For example, if four (4) packets are reassembled into one (1), 1 is displayed in this field.
pkts_drop_reassemble_overlap_frag	The number of packets not successfully reassembled and dropped due to overlapping reassembly fragments.
pkts_drop_reassemble_max_hold	The number of packets not successfully reassembled and dropped due to the

Statistic	Description
	arrival of too many fragments not yet reassembled. The maximum fragment sessions are already held for reassembly.
pkts_drop_reassemble_mem_full	The number of packets not successfully reassembled and dropped due to lack of memory for reassembly.
pkts_drop_reassemble_timed_out	The number of packets dropped due to timeout in the reassembly queue.

APF Statistics Definitions

The following table describes GigaSMART operations statistics for APF:

Statistic	Description
Apf Drop	The number of packets matching the GigaSMART drop rules.
Apf Pass	The number of packets matching the GigaSMART pass rules.
Rule Not Match	The number of packets not matching any GigaSMART rules in the map.
Masking Err	The number of masking errors in the map. This number is usually zero (0), which indicates no issues with the masking operation. If the number is non-zero, it indicates there is some issue with the masking operation.

ASF Statistics Definitions

The following table describes GigaSMART operations statistics for ASF:

Statistic	Description
Session Created	The number of sessions created.
Session Deleted	The number of sessions deleted.
Session Timeout	The number of sessions that were deleted due to inactivity (expiry of the session timer).
Session Matched (pkt)	The number of incoming packets matching ASF sessions. This count does not include the packets that triggered the creation of the session.
Exceed Count Drop	The number of packets dropped, even if they matched a flow session, because a packet-count was configured and exceeded.

Masking Statistics Definitions

The following table describes GigaSMART operations statistics for masking:

Statistic	Description
No Header	The number of packets with no configured masking protocol.
Too Short	The number of packets with a length less than the masking offset.

Slicing Statistics Definitions

The following table describes GigaSMART operations statistics for slicing:

Statistic	Description
No Header	The number of packets with no configured header for slicing.
Too Short	The number of packets with a length less than the slicing length.
Min Len	The number of packets that are sliced to less than 64 bytes.

Header Stripping Statistics Definitions

The following table describes GigaSMART operations statistics for header stripping:

Statistic	Description
Id No Hit	The number of packets that do not match the configured VXLAN ID to be stripped.
Fm 6000 Pkts Ts	The number of packets received with the FM6000 timestamp.
Unknown Next	The number of packets not stripped of their configured header type as the packets will have an unknown header after the header is stripped.
No Header	The number of packets with no configured header type to be stripped.
Fm 6000 Data Pkt Too Big	The number of FM6000 packets that are larger than 9600 bytes after the timestamp trailer is added. These packets will be dropped.
Fm 6000 Keyframe Overdue	The number of FM6000 key frames that are overdue. By default, the key frame rate is 1 packet per second. If a key frame is not received in 1 second, this statistic is incremented.
Fm 6000 Keyframe	The number of key frames received from the FM6000 device. Key frames are marker packets that carry information to convert the FM6000 timestamp to UTC time.

Generic Header Stripping Statistics Definitions

The following table describes GigaSMART operations statistics for generic header stripping:

Statistic	Description
first_anchor_header_not_present	The number of packets with no configured first anchor header.
offset_beyond_anchor_header_size	The number of packets that are not stripped as the configured offset size exceeds the size of the first anchor header.
second_anchor_header_not_present	The number of packets with no configured second anchor header.
strip_length_beyond_pkt_len	The number of packets that are not stripped as the configured strip length exceeds the packet length.
strip_success	The number of packets that are successfully stripped.
incompatible_anchor_headers	The number of packets that are dropped as the first anchor header is incompatible with the second anchor header after the stripping operation is complete.

Trailer Statistics Definitions

The following table describes GigaSMART operations statistics for trailers:

Statistic	Description
pkts_too_big	The number of packets for which the size of the packet has become greater than the maximum supported size (9600) when adding the trailer. This count is incremented with one trailer added to the packet.

FlowVUE Statistics Definitions

The following table describes GigaSMART operations statistics for FlowVUE:

Statistic	Description
Dev Ip Src Match	The number of packets with a source IP matching the range defined in the GigaSMART parameters (gsparams).
Exceed License Warn	The number flows that exceed the installed license.
Exceed License Err	The number of flows that exceed the installed license error limit. (The limit is the number of sessions in the license plus 5%.)
Dev Ip No Match	The number of packets with a source and destination IP that does not match any of the ranges defined in the GigaSMART parameters (gsparams).
Dev Ip Non Ip	The number of packets with no IP headers (and hence, not sampled).
Dev Ip Dst Match	The number of packets with a destination IP matching the range

Statistic	Description
	defined in the GigaSMART parameters (gsparams).
Out of Resource	The number of times there was a failure to allocate resources for recording a new flow. NOTE: The maximum supported flows for each engine port is 2 million.
Dev Ip Drop Not In Sample	The number of packets dropped by the sampling application, not because of errors, but because the flow was sampled to be dropped.

NetFlow Statistics Definitions

The following table describes GigaSMART operations statistics for NetFlow:

Statistic	Description
Out of Resource	The number of times there was a failure to allocate resources for recording a new flow. NOTE: The maximum supported flows for each engine port is 2 million.
Non Ip	The number of packets received that are not IPv4 or IPv6.
Non Configured	Packets received when NetFlow is not enabled in the GigaSMART group.
Ssl Active Sessions	The number of currently active SSL sessions monitored by NetFlow.
Total Ssl Sessions	The cumulative total number of SSL sessions monitored by NetFlow.

Display GigaSMART Application Resource Usage

GigaSMART applications, such as De-duplication and inline and out-of-band SSL decryption, use memory resources on the GigaSMART line card or module. As new GigaSMART applications are configured, the total resources on the GigaSMART line card or module can become fully used.

Starting in software version 4.4, you can display the GigaSMART application resource usage, which provides information about the applications that use resources. With this information, you can choose to free up resources on one application to use them on another.

Table 71: GigaSMART Application Resource Information

Name	Format
Gsgroup	The alias of the GigaSMART group associated with the GigaSMART application.
Application	The list of licensed GigaSMART applications that use resources, including Adaptive Packet Filtering (APF), de-duplication, GPRS Tunneling Protocol (GTP), NetFlow Generation, out-of-band SSL decryption, Adaptive Session Filtering (ASF) with buffering, and inline SSL decryption. Other GigaSMART applications (such as flow sampling, header addition, header stripping, ERSPAN tunnel decapsulation, slicing, masking, and others) do not have databases that store data, therefore they do not use resources and are not displayed with the show gsgroup gsapp-resource command.
% of Total	The percentage of the total amount of memory used by each GigaSMART application.
Configured Resource	The amount of resources configured for each GigaSMART application. The valid values are as follows: <ul style="list-style-type: none"> • app-max—Indicates the maximum amount of memory configured for the application. It is a pre-allocated amount. • integer, such as 2—Indicates the number of sessions configured, in the units specified. M indicates millions.
Installed Resource	The amount of resources installed for each GigaSMART application.
Licensed Quantity	The amount of resources licensed for each GigaSMART application.
Units	The units, such as sessions, or millions (M) of sessions.

Overview of GigaSMART Application Resources

GigaSMART application resources are managed per GigaSMART group (gsgroup). A gsgroup can be configured with one or more GigaSMART engine ports on one or more GigaSMART line cards or modules.

For most GigaSMART applications, resources are allocated automatically, based on configuration. For some GigaSMART applications, resources are allocated when they are configured in the gsgroup. For other applications, resources are allocated when a GigaSMART operation (gsop) using the application is created. For buffer ASF however, you can explicitly configure resources, in millions of sessions.

The allocation of resources for a new application will be successful if the application is licensed and if there is sufficient space for the new application.

If there is insufficient space, then the resources need to be managed to free up memory for the new application. Managing resources includes deleting applications that are no longer used.

However, deleting a GigaSMART application does not result in the immediate deletion of application resources. Once a resource has been allocated, it remains allocated. To delete resources for APF, out-of-band or inline SSL decryption, de-duplication, and GTP, remove the configuration related to the application, then reload the GigaSMART line card or module.

To remove the configuration related to an application, delete the `gsop` first, then delete the `gsgroup`. If the `gsop` or `gsgroup` is bound to a map, you will also have to delete the map.

Resources for Buffer ASF

The resources for buffer ASF depend on the number of sessions and the type of node. For example, on GigaVUE-HC2, 5 million sessions uses 62% of total resources, but on GigaVUE-HC3, 5 million sessions uses 26%.

For GigaVUE-HC3, the resources for buffer ASF for the number of sessions is as follows:

- 2 million—11% of total resources
- 3 million—16% of total resources
- 4 million—21% of total resources
- 5 million—26% of total resources

Reload GigaSMART Line Card or Module

Occasionally, the GigaSMART line card or module will need to be reloaded for changes to take effect and to allocate resources accordingly. Reloading also provides applications with contiguous memory.

The following message displays at the bottom of the output of the **show gsgroup gsapp-resource** command when the GigaSMART line card or module needs to be reloaded:

```
*Resource allocation changes have been made that require GigaSMART card 2/1/1 to be reloaded in order for them to take effect.
```

When this message is displayed, you cannot change the configuration relating to that application until after the reload. For example, you cannot use the `gsop`, associated with the `gsgroup`, in a map.

Use the following command to reload a GigaSMART line card or module:

```
(config) # card slot <slot ID> down
```

Use the following command to bring the GigaSMART line card or module back up:

```
(config) # no card slot <slot ID> down
```

GigaSMART CPU Utilization Statistics

You can display CPU utilization statistics for GigaSMART. The statistics indicate the performance of GigaSMART, improve visibility, and help identify high load conditions.

Show commands display instantaneous CPU utilization as well as historical, providing trends for CPU utilization.

You can also configure a rising threshold, as a percentage, to indicate when high CPU utilization occurs. When the aggregate CPU utilization percentage exceeds the rising the threshold, an SNMP notification can be triggered.

This feature is supported on all products that support GigaSMART: GigaVUE-HC1, GigaVUE-HC2, and GigaVUE-HC3.

The GigaSMART engine port (**e** port) numbers are e1 on nodes with one GigaSMART engine and e1 and e2 on nodes with two GigaSMART engines, for example: 10/1/e1 or 8/1/e1 and 8/1/e2.

Refer to the following sections for viewing statistics, configuring the threshold, and configuring a notification that can be sent when the threshold is exceeded:

- [Display GigaSMART CPU Utilization](#)
- [Configure Threshold](#)
- [Configure Threshold Crossing Notification](#)

Display GigaSMART CPU Utilization

Use the **show gsgroup stats all** command to display the statistics on all GigaSMART groups on the node.

The statistics are displayed for 1 second, 1 minute, 5 minute, 10 minute, and 15 minute intervals. The 1 second interval displays the statistics for the previous second. The 1 minute, 5 minute, 10 minute, and 15 minute intervals display statistics containing history.

Statistics are displayed in an aggregate form. For example, if there are two GigaSMART **e** ports: e1 and e2, there will be two aggregates. One aggregate will be for e1, the other will be for e2. The term aggregate refers to aggregation across all packet processing cores (up to 31) in the CPU. It does not refer to an aggregate across CPUs.

The statistics are as follows:

- Useful Time—Amount of time during which the CPU is processing packets, in milliseconds (ms) or seconds (s).

- Idle Time—Amount of time during which the CPU is not processing packets, for example, when it is busy looping, in milliseconds (ms) or seconds (s).
- In Packets (pkts/s)—Number of packets per second coming into the CPU. For the 1 second interval, In Packets is the actual number of incoming packets for that second. For the 1 minute, 5 minute, 10 minute, and 15 minute intervals, In Packets is an average number of incoming packets per second.
- Packets Drop (pkts/s)—Number of packets per second dropped by the CPU. For the 1 second interval, Packets Drop is the actual number of dropped packets for that second. For the 1 minute, 5 minute, 10 minute, and 15 minute intervals, Packets Drop is an average number of dropped packets per second.
- Packets Recv Error—Number of received packets per second with errors. For the 1 second interval, Packets Recv Error is the actual number of errored packets for that second. For the 1 minute, 5 minute, 10 minute, and 15 minute intervals, Packets Recv Error is an average number of errored packets per second.
- CPU Usage %—Percentage of time during which the CPU is processing packets. CPU Usage % plus CPU Idle % equals 100.
- CPU Idle %—Percentage of time during which the CPU is not processing packets. CPU Idle % plus CPU Usage % equals 100.

NOTE: When the node is restarted, the 1 minute, 5 minute, 10 minute, and 15 minute statistics will not be exactly for 1 minute, 5 minute, 10 minute, and 15 minute intervals, until the full interval has elapsed and the history is available.

Configure Threshold

An upper threshold (rising) can be configured. When the aggregate value of the CPU utilization on the GigaSMART engine exceeds the threshold, an SNMP notification can be triggered. Refer to [Configure Threshold Crossing Notification](#).

Configure Threshold Crossing Notification

When the aggregate value of the CPU utilization exceeds the upper (rising) threshold, a message is logged, and optionally, an SNMP notification is sent to all configured destinations.

When enabled, the SNMP notification is sent when the rising threshold is exceeded in any 5-second interval over which the CPU utilization is averaged.

NOTE: Once the rising threshold is exceeded for 5 seconds, the SNMP notification is generated. However, if the CPU utilization falls below the upper threshold but does not remain below that threshold continuously for 5 seconds, a new notification is not generated

when the upper threshold is exceeded again. A new notification is generated only when the CPU utilization falls below the threshold, stays below the threshold continuously for 5 seconds, exceeds the threshold again, and stays above it for 5 seconds.

How to Use GigaSMART Trailers

Required License: Base

GigaSMART operations can add the GigaSMART Trailer to packets, providing metadata on the packet and how it was processed.

GigaSMART Trailers are optional for some GigaSMART operations. For example, trailers can be included with Masking but not with Slicing. Refer to [How to Combine GigaSMART Operations](#) for the valid combinations.

If a trailer is included, it can optionally include the original packet's CRC as one field and a Source ID as another. The Source ID indicates where the packet entered the GigaVUE H Series node and how it was processed. Refer to [About the Source ID Field](#) for information included in the Source ID field.

Trailer operations can be assigned to GigaSMART groups consisting of multiple engine ports. Refer to [Groups of GigaSMART Engine Ports](#) for details.

About the Source ID Field

When you enable the **Source ID** field for the GigaSMART Trailer, the trailer includes an additional field that identifies the platform type, box ID, slot number, and port number of the network port where the packet entered the GigaVUE H Series node. Refer to [Format of the GIGAMON_SRCID TLV](#) for the exact details.

Keep in mind the following when configuring GigaSMART operations with a **Source ID** argument:

Feature	Description
Source ID Field in GigaSMART Trailer	<p>The Source ID field in the Gigamon Trailer includes the following values:</p> <ul style="list-style-type: none"> • Platform Type – The type of GigaVUE node where the packet was first seen. • Group ID – The cluster ID/group ID configured for the node on which the packet was received. The GigaVUE H Series uses cluster IDs; the GigaVUE G Series uses group IDs. • Box ID – The box ID configured for the GigaVUE node on which the packet was received. Box IDs are used for unique identification of nodes in a cluster.

Feature	Description
	<p>NOTE: The box ID field in the Gigamon Trailer supports box ID values from 0-63, inclusive.</p> <ul style="list-style-type: none"> • Slot ID – The slot ID for the port on which the packet was received. • Port ID – The physical port number on which the packet was received.

Example – GigaSMART Source Labeling with a GigaSMART Trailer

This example creates a GigaSMART operation named **src_headermask** with **Masking** and **Trailer** components. This operation will mask packets using a static masking offset of 148 bytes that continues for the next 81 bytes, writing over the existing data with an FF pattern. Then it attaches a GigaSMART Trailer indicating the original size of the packet before masking, the original packet's CRC, and the box ID, slot ID, and port ID of the physical input port on the GigaVUE H Series node. [Figure 519: GigaSMART Operation with Masking and Trailer Components](#) shows the GigaSMART operation with masking an trailer components.

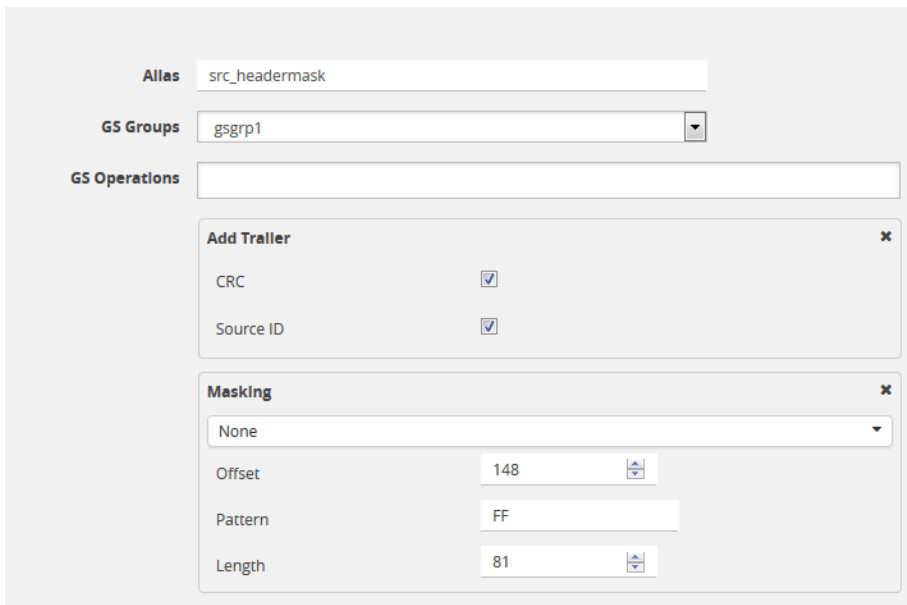


Figure 519: GigaSMART Operation with Masking and Trailer Components

Remove GigaSMART Trailers

You can also construct GigaSMART operations that remove the GigaSMART Trailer from packets. These operations are useful in cases where you have cascade connections – a tool port receiving packets with a GigaSMART trailer is physically cabled to a GigaVUE H Series network port, sending

the packets received on the tool port back into a GigaVUE H Series node. You may want to remove the GigaSMART trailer before the packets are forwarded to other tools – that is when the special **Remove Trailer** argument comes in handy. [Figure 520: Remove Trailer Enabled](#) shows Remove Trailer enabled for a GigaSMART operation.

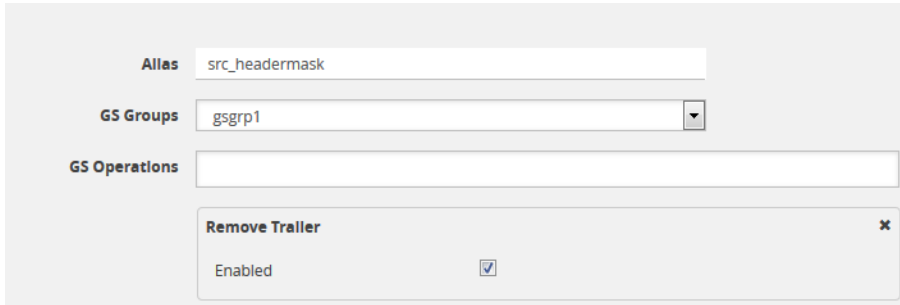
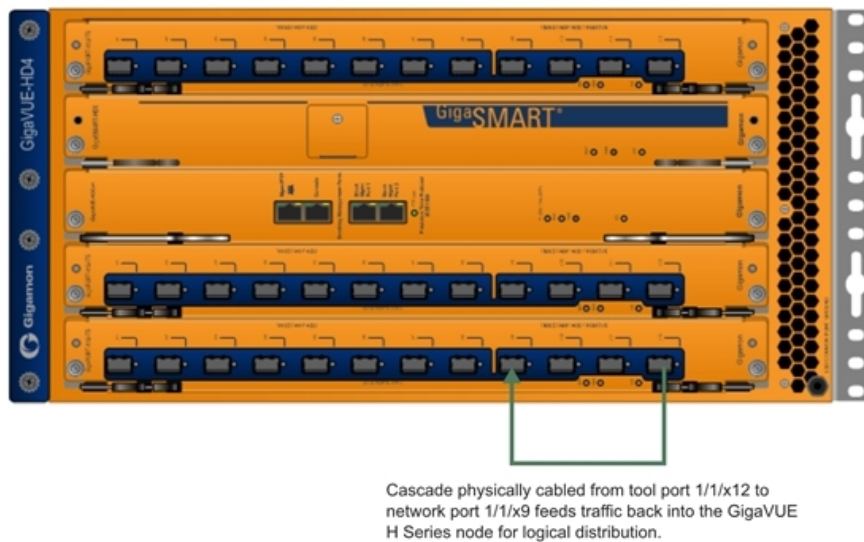


Figure 520: Remove Trailer Enabled

Example: Removing GigaSMART Trailers in a Cascade

[Figure 521: Cascade Physically Cabled from Tool to Network Port](#) and [Figure 522: Removing the GigaSMART Trailer from a Cascade Connection](#) illustrate a situation where a GigaSMART operation that removes the GigaSMART trailer would be useful. Consider the physical deployment shown in [Figure 521: Cascade Physically Cabled from Tool to Network Port](#):

- The **green** illustrates a one-way cascade between a tool (output) port (port 1/1/x12) and a network (input) port (port 1/1/x9).
- If traffic arriving on port 1/1/x12 includes a GigaSMART Trailer, you may want to use a **Trailer Remove** GigaSMART operation to remove it before logically forwarding traffic from port 1/1/x9 to another port on the GigaVUE.



Cascade physically cabled from tool port 1/1/x12 to network port 1/1/x9 feeds traffic back into the GigaVUE H Series node for logical distribution.

Figure 521: Cascade Physically Cabled from Tool to Network Port

For example, consider the packet distribution shown in [Figure 522: Removing the GigaSMART Trailer from a Cascade Connection](#):

- The map named **add_trailer** is bound to network port 1/1/x1..x2. It adds the GigaSMART trailer and sends it to tool ports 1/1/x5..x8.
- Tool ports 1/1/x5..x7 are all connected to tools that expect the extra data in the GigaSMART Trailer.
- Tool port 1/1/x8 is physically cabled to network port 1/1/x4 in a cascade. To remove the GigaSMART Trailer from packets arriving on this port before they are forwarded to tool port 1/1/x9, we have bound a map named **no_trailer** to network port 1/1/x4 that is configured to remove the GigaSMART Trailers from all arriving packets.
- Tool port 1/1/x9 receives packets without the GigaSMART Trailer attached.

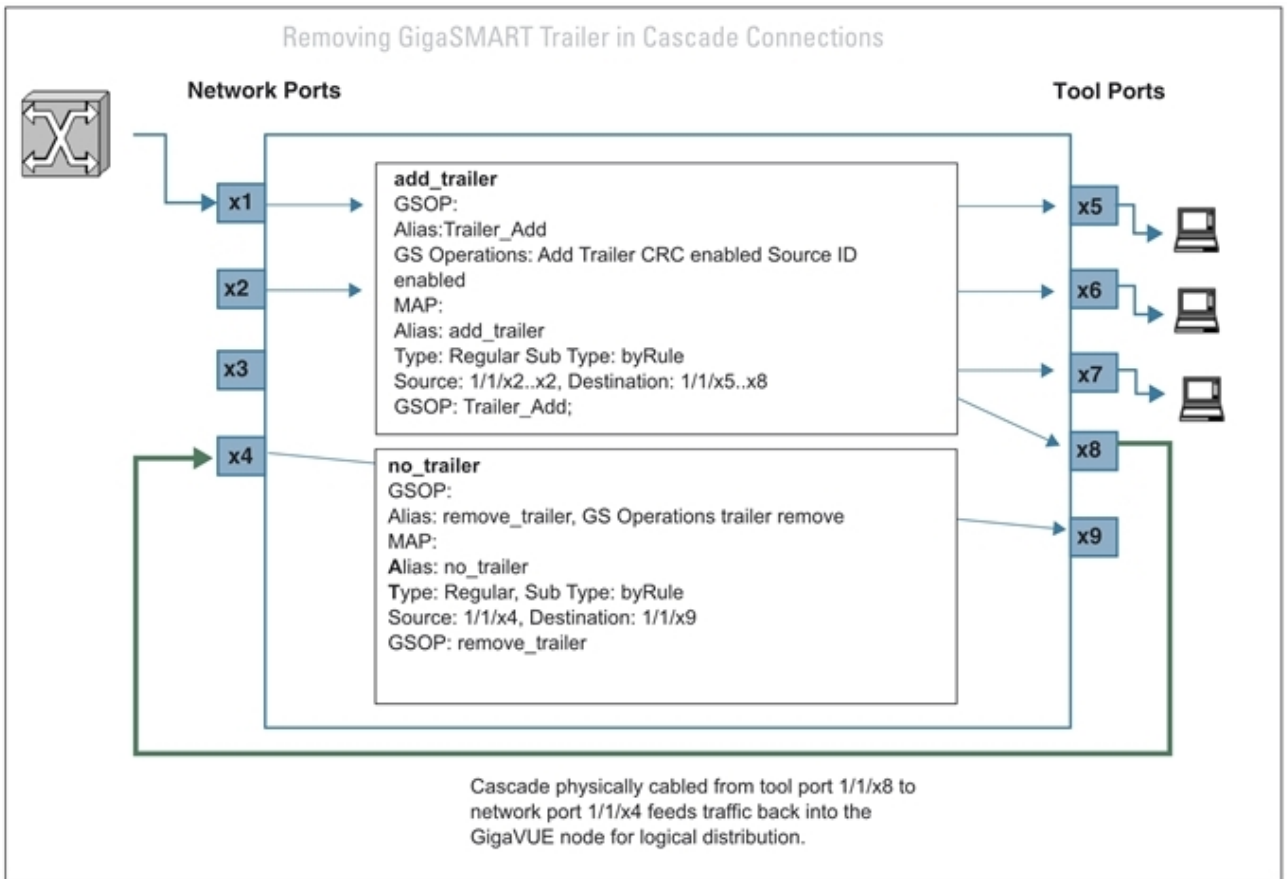


Figure 522: Removing the GigaSMART Trailer from a Cascade Connection

Multiple GigaSMART Trailers and Cascade Connections

Cascade connections also make it possible for multiple GigaSMART trailers to be attached to the same packet. For example, consider the cascade shown in [Figure 522: Removing the GigaSMART Trailer from a Cascade Connection](#) and suppose that instead of the **no_trailer** map removing the GigaSMART Trailer on packets arriving over the cascade physically cabled from tool port 1/1/x8 that there is a second GigaSMART operation adding another trailer. In cases like this, the GigaSMART adds the most recent trailer at the end of the packet.

The same principle works for the **Remove Trailer** operations:

- The most recent trailer is removed from the end of the packet. Any other trailers are left intact by a single Remove operation.

Interpret GigaSMART Trailer

The trailer inserted by the GigaSMART line card can be interpreted using a recent version of the Wireshark[®] Protocol Analyzer. Refer to [GigaSMART Trailer Reference](#) for details on the GigaSMART Trailer and its TLVs.

GigaSMART Trailer Reference

This section provides reference information on the format, position, and contents of the Gigamon Ethertype and GigaSMART Trailer fields in a packet processed by the GigaSMART-HD0 line card.

Refer to [How to Use GigaSMART Trailers](#) for details on how the GigaSMART Trailer is used in packets.

GigaSMART Trailer Format

This section describes the format of the GigaSMART Trailer. [Figure 523: GigaSMART Trailer Format](#) summarizes the position and contents of the GigaSMART Trailer and the Gigamon Ethertype field (0x22E5).

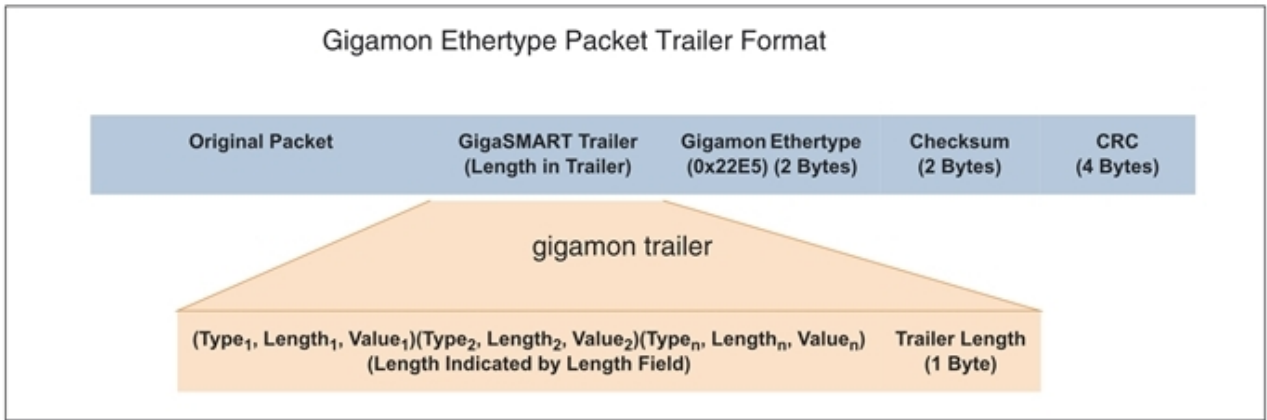


Figure 523: GigaSMART Trailer Format

GigaSMART Trailer Format

GigaSMART operations can insert metadata as a trailer at the end of the packet. As shown in the following figure, the GigaSMART Trailer consists of one or more TLVs, followed by the Trailer Length Field. The GigaSMART Trailer is followed by the Gigamon Ethertype, a Checksum, and a recalculated CRC for the packet.

(Type ₁ , Length ₁ , Value ₁)(Type ₂ , Length ₂ , Value ₂) (Type _n , Length _n , Value _n) (Length Indicated by Length Field)	Trailer Length (1 Byte)	Gigamon Ethertype (0x22E5) (2 Bytes)	Checksum (2 Bytes)
---	----------------------------	---	-----------------------

Table 72: Gigamon Trailer Format lists and describes each of the fields in the GigaSMART Trailer:

Table 72: Gigamon Trailer Format

Field	Description
TLVs	TLVs are used to carry the metadata inserted by GigaSMART operations. Within a TLV, the Type and Length fields are each one byte long. The size of the Value field is indicated by the Length field. Refer to GigaSMART Trailer TLVs for a summary of the available TLVs and their formats.
Length	Specifies the size of the GigaSMART trailer. The Trailer Length includes the Length byte itself.
Gigamon Ethertype	Two-byte field identifying packet modified by GigaSMART line card. Value is 0x22E5. Protocol analysis equipment can use the Gigamon Ethertype in the trailer to find the start of the trailer: <ul style="list-style-type: none"> • Move one byte to left to find Trailer Length Field. • Read the number of bytes for the Trailer Length and move the number of bytes specified to the left to find the start of the

Field	Description
	Trailer.
Checksum	Two-byte field used to validate that extra data is in fact a trailer and not random data with the Gigamon Ethertype.

GigaSMART Trailer TLVs

This section lists and describes the format of the Gigamon TLVs used in this release. TLVs are used to carry the metadata inserted by GigaSMART operations. Within a TLV, the Type and Length fields are each one byte long. The size of the Value field is indicated by the Length field.

Table 73: Gigamon TLVs

Tag Type	TLV ID	Value Field Length (Bytes)	Description
GIGAMON_PKT_LEN	1	2	Original Packet Length This TLV is included in any packet with a GigaSMART Trailer – adding the Trailer changes the original packet length.
GIGAMON_SRCID_G	2	3	Original Packet Source Identifier (GigaVUE G Series) This TLV is included in any packet processed by a GigaSMART operation configured to include the Source ID field as part of its trailer. Refer to Format of the GIGAMON_SRCID TLV for a description of how the physical input source is encoded.
GIGAMON_TIMESTAMP	3	8	Timestamp – System Clock
GIGAMON_TIMESTAMP_NTP	4	8	Timestamp – NTP Clock Source
GIGAMON_TIMESTAMP_GPS	5	8	Timestamp – GPS Clock Source
GIGAMON_TIMESTAMP_1588	6	8	Timestamp Based on PTP (IEEE 1588)
GIGAMON_CRC	7	4	Original Packet CRC This TLV is included in any packet processed by a GSOP configured to include the

Timestamp
A Timestamp TLV is included in any packet processed by a timestamp GigaSMART operation. The Timestamp always indicates the UTC time at which the last byte of the packet was seen by the GigaSMART line card or module. In addition, the exact type of Timestamp TLV indicates the time source used (NTP, GPS, and so on).
Note that timestamp GigaSMART operations are not yet supported in this release of the GigaVUE H Series node.

Tag Type	TLV ID	Value Field Length (Bytes)	Description
			original packet's CRC as part of its trailer (the CRC option is selected in the Trailer Add argument).
GIGAMON_SRCID	8	4	Original Packet Source Identifier (GigaVUE H Series) This TLV is included in any packet processed by a GigaSMART line card on a GigaVUE H Series node configured to include the Source ID field as part of its trailer. Refer to Format of the GIGAMON_SRCID TLV for a description of how the physical input source is encoded.
GIGAMON_TIMESTAMP_1588	6	8	Timestamp – PTP (IEE 1588) Clock Source

Format of the GIGAMON_SRCID TLV

The GIGAMON_SRCID TLV is included in any packet processed by a **Source ID** GigaSMART operation. The GIGAMON_SRCID TLV consists of 3 bytes indicating the platform type, group ID, box ID, and port ID for the physical port where the packet entered the GigaVUE H Series node:

GIGAMON_SRCID TLV (32 Bits/4 Bytes)				
Platform (6 Bits)	Group ID (4 Bits)	Box ID (6 Bits)	Slot ID (6 Bits)	Port ID (10 Bits)

Name	Description	Bits
Platform	The type of GigaVUE node where the packet was first seen. Can be one of the following: <ul style="list-style-type: none"> 0 – Unknown 1 – GigaVUE-2404 2 – GigaVUE-420 3 – GigaVUE-MP 4 – GigaVUE-HD4 5 – GigaVUE-HD8 6 – GigaVUE-212 7 – GigaVUE-HB1 	6

Name	Description	Bits
	<ul style="list-style-type: none"> • 8 – GigaVUE-HC2 • 9 – GigaVUE-TA1 • 10 – GigaVUE-TA10 • 11 – GigaVUE-TA40 • 12 – GS_CHASSIS_TYPE_LY2 (white box) • 13 – GigaVUE-TA100 • 14 – GigaVUE-TA100 CXP • 15 – GigaVUE-HC1 • 16 – GigaVUE-HC3 • 17 – GigaVUE-TACS • 18 – GigaVUE-TA200 	
Group ID	Group IDs are used to identify a particular cluster. If a packet enters a cluster with a group ID configured, it is reflected here.	4
Box ID	Box IDs are used to uniquely identify nodes in a cluster. Standalone systems typically have the default box ID of 1 here. NOTE: The box ID field in the Gigamon Trailer supports box ID values from 0-63, inclusive.	6
Slot ID	The number of the slot including the physical port for the packet.	6
Port ID	The physical input port number for the packet. Refer to Port ID Values by Line Card Type for a summary of the values used by GigaVUE H Series line card.	10

Port ID Values by Line Card Type

The following table summarizes the values inserted in the GIGAMON_SRCID TLV for port ID by GigaVUE device and line card type:

GigaVUE Device / Line Card	Ports	Port IDs Inserted in Gigamon Trailer
GigaVUE-HC1		
HC1-X12G4	x1..x12	5..16
	g1..g4	1..4
BPS-HC1-D25A24	x1..x4	53..56
	x5..x8	49..52
PRT-HC1-X12	x1..x12	49..60

GigaVUE Device / Line Card	Ports	Port IDs Inserted in Gigamon Trailer
GigaVUE-HC2		
PRT-HC0-X24	x1..x24	1..24
PRT-HC0-Q06	q1..q6	1..6
BPS-HC0-D25A4G	x1..x16	1..16
	x17..x24	17..24
BPS-HC0-D25B4G	x1..x16	1..16
	x17..x24	17..24
BPS-HC0-D35C4G	x1..x16	1..16
	x17..x24	17..24
BPS-HC0-Q25A28	x1..x8	1..8
	q1x1..q4x4	9..24
	q1..q4	9, 13, 17, 21
SMT-HC0-X16	x1..x16	1..16
PRT-HC0-C02	c1..c2	1..2
GigaVUE-HC3		
PRT-HC3-X24	x1..x24	1..24
PRT-HC3-C08Q16	c1..c8	1, 5, 9, 13, 17, 21, 25, 29
PRT-HC3-C08Q16-4x10Gb Mode	c1x1-x4.. c8x1-x4	1..32
PRT-HC3-C08Q16-4x25Gb Mode on Control Card Version 2	c1x1-x4.. c8x1-x4	1..32
SMT-HC3-C05	c1..c5	1, 5, 9, 13, 17
SMT-HC3-C05-4x10Gb Mode	c1x1-x4.. c5x1-x4	1..20
SMT-HC3-C05-4x25Gb Mode on Control Card Version 2	c1x1-x4.. c5x1-x4	1..20
BPS-HC3-C25F2G	x1..x16	1..16
	c1..c4	17, 21, 25, 29

GigaVUE Device / Line Card	Ports	Port IDs Inserted in Gigamon Trailer
BPS-HC3-C35F2G	x1..x16	1..16
	c1..c4	17, 21, 25, 29
BPS-HC3-Q35F2G	x1..x16	1..16
	q1..q4	17, 21, 25, 29
PRT-HC3-C16	c1..c16	1, 5, 6, 10, 11, 15, 16, 20, 21, 25, 26, 30, 31, 35, 36, 40
PRT-HC3-C16-4x10Gb Mode	c1x1..x4	1..4
	c3x1..x4	6..9
	c5x1..x4	11..14
	c7x1..x4	16..19
	c9x1..x4	21..24
	c11x1..x4	26..29
	c13x1..x4	31..34
	c15x1..x4	36..39
PRT-HC3-C16-4x25Gb Mode	c1x1..x4	1..4
	c3x1..x4	6..9
	c5x1..x4	11..14
	c7x1..x4	16..19
	c9x1..x4	21..24
	c11x1..x4	26..29
	c13x1..x4	31..34
	c15x1..x4	36..39
GigaVUE-TA Series		
GigaVUE-TA10	x1..x48	1..48
	q1..q4	65..68
GigaVUE-TA40	q1..q32	1, 5, 9, 13, 17, 21, 25, 29, 33, 37, 41, 45, 49, 53, 57, 61, 65, 69, 73, 77, 81, 85, 89, 93, 97, 101

GigaVUE Device / Line Card	Ports	Port IDs Inserted in Gigamon Trailer
	q1x1..q12x4	1..48
	q21x1..q32x4	57..104
GigaVUE-TA100	c1..c32	1, 5, 9, 13, 17, 21, 25, 29, 33, 37, 41, 45, 49, 53, 57, 61, 65, 69, 73, 77, 81, 85, 89, 93, 97, 101, 105, 109, 113, 117, 121, 125
	c1x1..c32x4	1..128
GigaVUE-TA200	c1..c64	1, 5, 9, 13, 17, 21, 25, 29, 33, 37, 41, 45, 49, 53, 57, 61, 65, 69, 73, 77, 81, 85, 89, 93, 97, 101, 105, 109, 113, 117, 121, 125, 42, 43, 54, 55, 68, 59, 60, 46, 47, 48, 50, 51, 52, 62, 63, 64, 66, 67, 78, 70, 79, 82, 83, 84, 71, 86, 72, 74, 75, 76, 87, 88
	c1x1..c32x4	1..128

GigaSMART Trailer Example

The following figures show a sample GigaSMART trailer with the packet length and source ID TLV included. The total length of the trailer in this example is 10 bytes, plus another 5 bytes for the Trailer Length, Ethertype, and Checksum fields.

GIGAMON_PKT_LEN TLV			GIGAMON_SRCID TLV							Trailer Length, Ethertype, Checksum		
GIGAMON_PKT_LEN=1 (1 Byte)	TAG_LEN=2 (1 Byte)	PKT_LEN (2 Bytes)	GIGAMON_SRCID Type (1 Byte)	GIGAMON_SRCID Length (1 Byte)	Platform (6 Bits)	Group ID (4 Bits)	Box ID (6 Bits)	Slot ID (6 Bits)	Port ID (10 Bits)	Length=10 (0a) (1 Byte)	Ethertype=0x22E5 (2 Bytes)	Checksum (2 Bytes)

← GIGAMON_SRCID Value (4 bytes) →

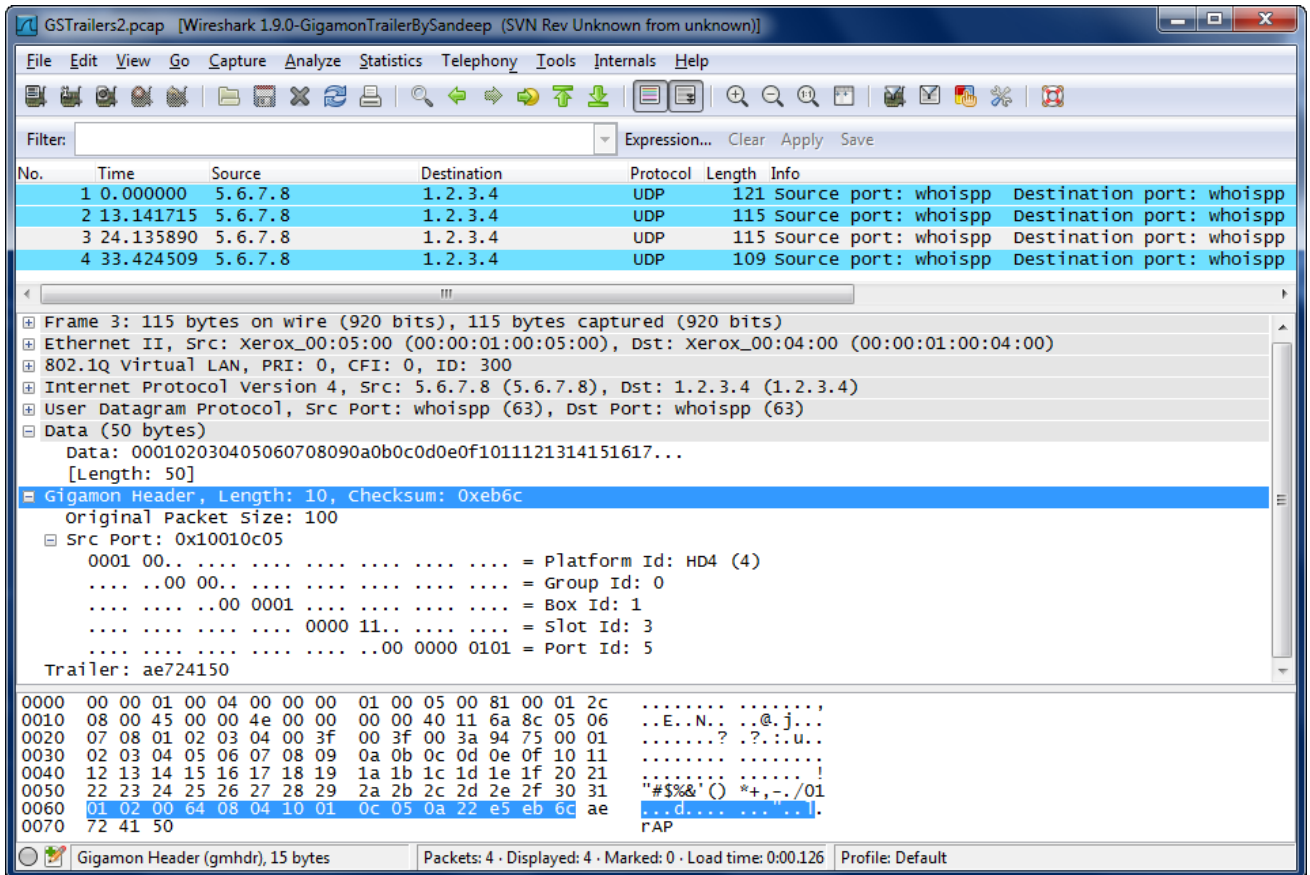



Figure 524: Wireshark Decode of GigaSMART Trailer

GigaSMART Logs

As of 5.4, GS Log files enable you to generate and download application-specific logging information to use for troubleshooting problematic applications. Gigamon Support can use these files for root cause analysis.

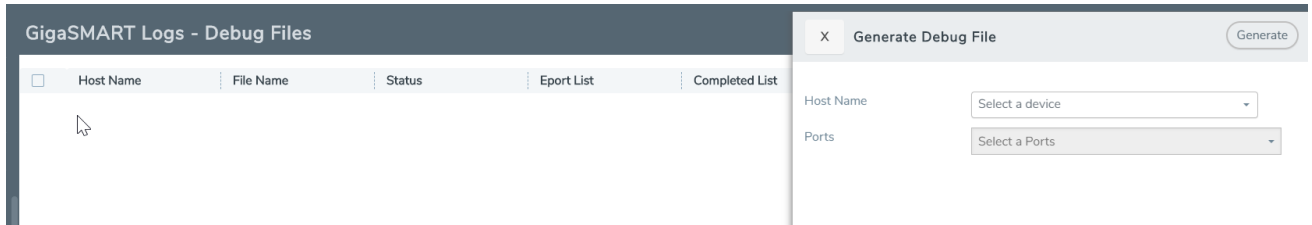
GS Log levels are applied at the process level by specifying **info** or *debug* when configuring the logging level for the application's processes. Logging levels modified at the application level will take priority over the system level setting.

To access Logs, click  on the top navigation bar. On the left navigation pane, select **System > Logs**.

Create GS Log file

To create a log file that Gigamon can use for analysis, do the following:

1. Access a device: Physical > Physical Node > click the Cluster ID for a node.
2. Under Support in the navigation pane, select **Debug > GigaSMART Logs**.
3. Click **Generate**.
4. Select the Host Name and Ports.



The system generates a new GS Log file.

5. Select the GS Log file to download, and then click **Download**.

You can only download one file at a time.

The system downloads the file to your local environment with a name like, gsdump_<hostname>_<date>_<time>.tgz.gpg. The file is in a compressed and encrypted format that you can provide to Gigamon.

Delete Log File

To delete the GS Log files for clearing up the disk space:

1. Select **Debug > GS Logs**.
2. Select the GS Logs that you want to delete and click **Delete**.

Virtual and Cloud

In addition to providing traffic visibility in your on-premise data centers, Gigamon solutions provide complete network traffic visibility across your virtual, private cloud and public cloud environments. Gigamon offers the following solutions to eliminate network blind spots and reduce security risks in your virtual and cloud environments:

- GigaVUE Cloud Suite for VMware
- GigaVUE Cloud Suite for the various cloud platforms

Refer to the respective cloud guides for more details.

VMware Environment

The GigaVUE Cloud Suite for VMware extends GigaVUE traffic distribution principles to the virtualized environments, allowing users to filter, monitor, and forward traffic on the virtual machines to GigaVUE nodes for distribution to monitoring and analysis tools. The GigaVUE-VM solutions provide virtual visibility in the following environments:

- VMWare vCenter
- VMWare NSX

Refer to the *GigaVUE Cloud Suite for VMware Configuration Guide* for instructions on installing, deploying, and operating the GigaVUE® Virtual Machine (GigaVUE-VM).

Public and Private Cloud Environments

The GigaVUE Cloud Suite solution for the various cloud platforms offers network traffic visibility in the respective cloud platforms. The GigaVUE Cloud Suite solutions acquire, optimize and distribute selected traffic to security and monitoring tools.

Cloud Platform	Guides
Public Cloud	
AWS	GigaVUE Cloud Suite for AWS Configuration Guide
Azure	GigaVUE Cloud Suite for Azure Configuration Guide
Private Cloud	
OpenStack	GigaVUE Cloud Suite for OpenStack Configuration Guide

Cloud Platform	Guides
Container Visibility	
Kubernetes	GigaVUE Cloud Suite for Kubernetes Container Visibility Configuration Guide
Cloud Platforms	
AnyCloud	GigaVUE Cloud Suite for AnyCloud Configuration Guide

The guides provide instructions on configuring the GigaVUE Cloud components and setting up traffic monitoring sessions for the respective Cloud platform.

GigaVUE-FM Reference

This section provides additional information useful for GigaVUE-FM. The following topics are covered:

- [Disk Size on GigaVUE-FM](#)
- [Data Transfer Rate Units](#)
- [Open Ports in GigaVUE-FM](#)
- [Health Status](#)

Disk Size on GigaVUE-FM

This section describes how to increase the storage space available on GigaVUE-FM in VMware ESXi, Microsoft Hyper-V, and KVM environments. It also explains how to clear the space in the /var directory.

After installing GigaVUE-FM, the size of /config can be increased by adding disk and then rebooting GigaVUE-FM. [Increase Disk Size on a New or Existing GigaVUE-FM Installation](#) describes increasing the disk size for a new or existing GigaVUE-FM installation as well as for an upgrade from previous releases. Ensure that you apply this procedure only to GigaVUE-FM version 3.1 or higher.

Increase Disk Size on a New or Existing GigaVUE-FM Installation

To increase disk size on a new GigaVUE-FM installation, do the following:

1. To verify the disk size through the GigaVUE-FM CLI, use the following command:

```
config(#) show files system
```

Statistics for /config file system

Space Total	19777 MB
Space Used	1275 MB
Space Free	18501 MB
Space Available	17497MB
Space Percent Free	93%
Inodes Percent Free	99%

Statistics for /var filesystem

Space Total	10079 MB
Space Used	359 MB
Space Free	9721 MB
Space Available	9209 MB
Space Percent Free	96%
Inodes Percent Free	99%

2. From the vSphere Client, select **Edit Settings > Hardware > Add**.
3. Select Hard Disk as shown in [Figure 5-1:Select Hard Disk from vSphere Client](#).

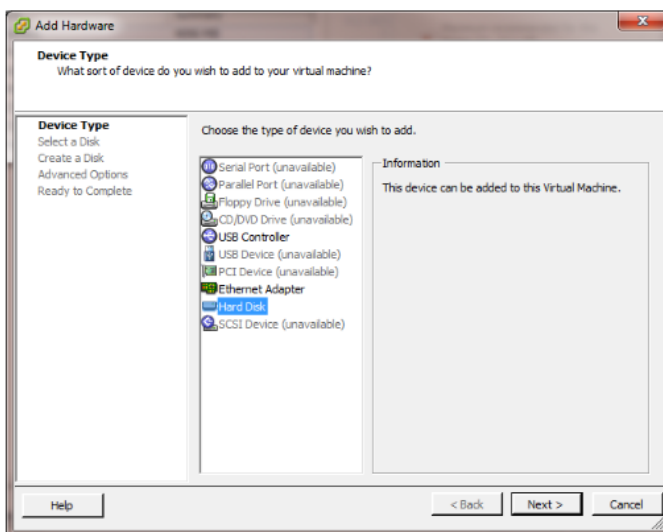


Figure 5-1:Select Hard Disk from vSphere Client

4. Click **Next**.
5. Select the size of the disk as desired. In [Figure 1: Example Shows the Disk Size Set as 16GB](#), the size is set to 16GB. Ensure only Thick Provisioning is selected.

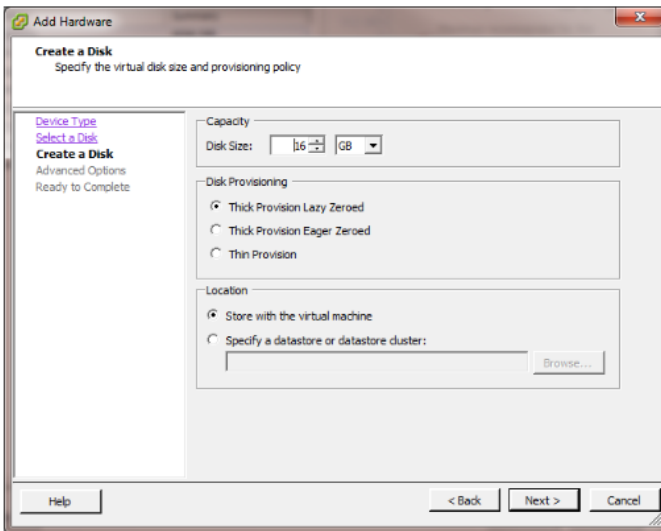


Figure 1: Example Shows the Disk Size Set as 16GB

6. Click **Next**.
7. The default for the Virtual Device Node is displayed in the dialog as shown in [Figure 2: Default Selection for Virtual Device Node](#) . It is best to keep the default.

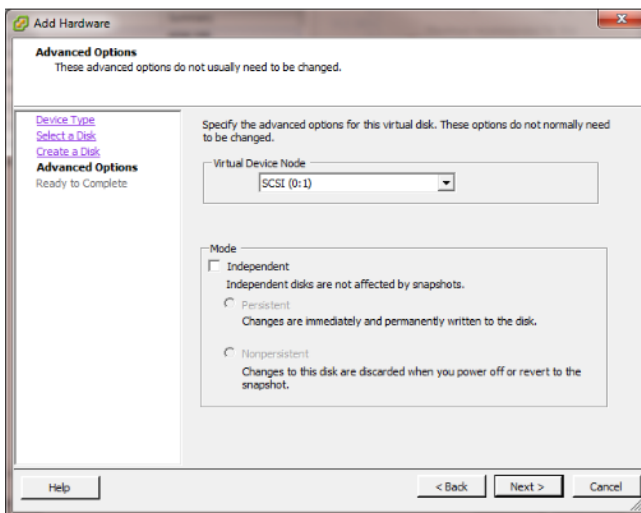


Figure 2: Default Selection for Virtual Device Node

8. Click **Next** for summary and complete by clicking **Finish**. [Figure 3: Summary Screen for Disk Capacity](#) shows an example of the Summary.

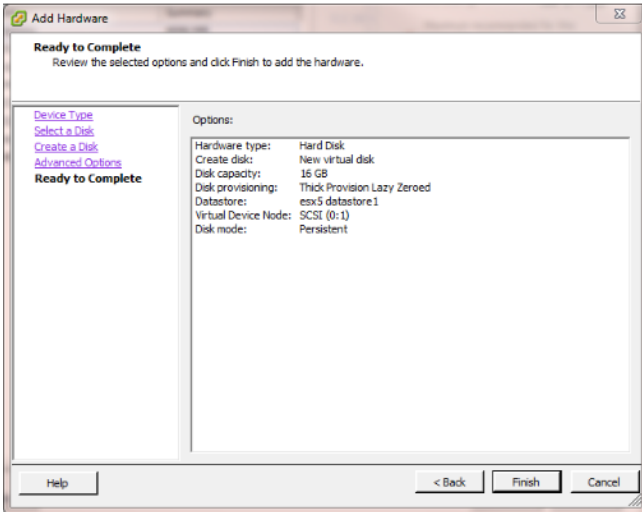


Figure 3: Summary Screen for Disk Capacity

9. After clicking **Finish**, the Edit Settings dialog reopens where you will see the new hard disk information in the list.

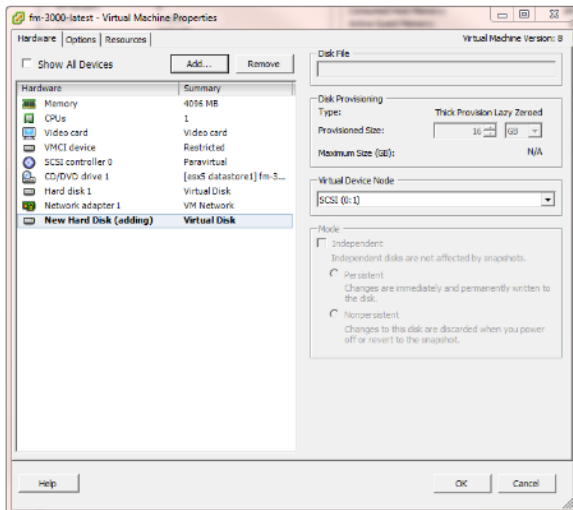


Figure 4: Edit Settings Screen with the New Hard Disk Displayed

10. After verifying the information in the Edit Settings dialog, click **OK** and reboot the GigaVUE-FM using **Restart Guest OS** in vSphere.

As GigaVUE-FM reboots, messages will appear on the screen showing the change in the disk size. [Figure 5: GigaVUE-FM Rebooting Shows the Increased Disk Size](#) shows an example.

NOTE: For /var, the size is fixed at 10GB. When the size is increased by adding a new disk, only the size of /config is increased.

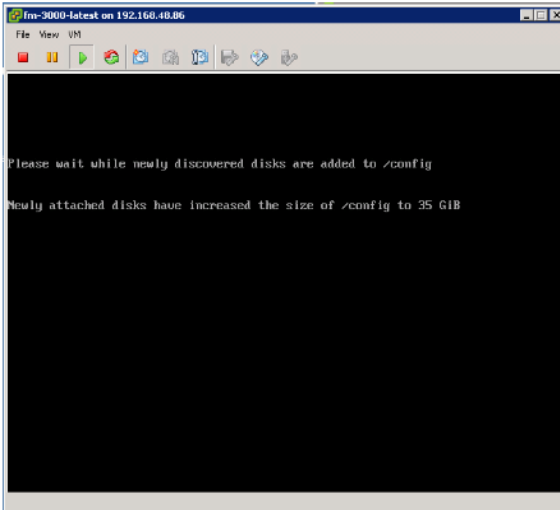


Figure 5: GigaVUE-FM Rebooting Shows the Increased Disk Size

11. To verify the disk size after a disk size increase through the GigaVUE-FM CLI, use the show files system command.

The following is an example after an upgrade.

```
config(#) show files system
```

Statistics for /var filesystem:

Space Total	10079 MB
Space Used	358 MB
Space Free	9721 MB
Space Available	9209 MB
Space Percent Free	96%
Inodes Percent Free	99%

Statistics for /config filesystem:

Space Total	35900 MB
Space Used	1279 MB
Space Free	34621 MB
Space Available	32797 MB
Space Percent Free	96%
Inodes Percent Free	99%

How to Clean up Disk Space on a GigaVUE-FM Instance

The /var directory can sometimes run out of storage space and result in performance degradation of GigaVUE-FM. The best practice is to periodically check the storage space (refer to the *"Storage Management"* section in the *GigaVUE-OS and GigaVUE-FM Administration Guide*) and clear up the disk space to avoid system misbehavior.

The disk space on a GigaVUE-FM Instance can be cleared up in multiple ways:

- Purging the statistics older than a certain date. For more information, refer to the *"Storage Management"* section in the *GigaVUE-OS and GigaVUE-FM Administration Guide*.
- Removing the unused internal images. For more information, refer to the *"Internal Image Files"* section in the *GigaVUE-OS and GigaVUE-FM Administration Guide*.
- Deleting the logs. For more information, refer to the *"Delete Log File"* section in the *GigaVUE-OS and GigaVUE-FM Administration Guide*.

Data Transfer Rate Units

Data Transfer Rate is measured as multiples of unit bits per second (bit/s) or as bytes per second (B/s). The transfer rates shown on the dashboard and in other places are measured as decimal multiples of bits. The following table shows the units of data transfer:

Table 1: Decimal Multiple of Data Transfer Rate in Bits

Data Rate	Symbol	Rate
Kilobit per second	kbps	1000 bits per second
Megabit per second	Mbps	1,000,000 bits per second
Gigabit per second	Gbps	1,000,000,000 bits per second

NOTE: 8 kilobits = 1 kilobyte

Table 2: Decimal Multiple of Data Transfer Rate in Bytes

Data Rate	Symbol	Rate
Kilobyte per second	kBps	8000 bits per second
Megabyte per second	MBps	8,000,000 bits per second
Gigabyte per second	GBps	8,000,000,000 bits per second
Terabyte per second	TBps	8,000,000,000,000 bits per second

Open Ports in GigaVUE-FM

This appendix provides information about the open ports in GigaVUE-FM and also in the devices.

The following table provides information about the default ports open in the firewall for GigaVUE-FM. The [Open Default Ports](#) table is sorted by Protocol and then Port Number.

Table C-1: Open Default Ports

Port Number	Protocol	Service	Traffic Direction	Description
80	HTTP	GigaVUE-FM GUI	Bidirectional traffic between Web Browser and GigaVUE-FM	Used for redirecting the traffic internally to port 443. Note: You can choose to shut down port 80 for enhanced security.
443	HTTPS	GigaVUE-FM GUI	Bidirectional traffic between Web Browser and GigaVUE-FM Bidirectional traffic between GigaVUE-FM and GigaVUE-VM.	Used for normal GigaVUE-FM user interaction.
389	LDAP	AAA	Bidirectional traffic between LDAP server and GigaVUE-FM	Used for accessing and maintaining distributed directory information services over the Internet Protocol (IP) network.
636	LDAP	AAA	Bidirectional traffic between LDAP server and GigaVUE-FM	Used for secure LDAP protocol over SSL for accessing and maintaining distributed directory information services over the Internet Protocol (IP) network.
1812/1813 1645/1646	Radius	AAA	Bidirectional traffic between Radius server and GigaVUE-FM	Used for running the client/server protocol in the application layer. They can use either TCP or UDP as the transport protocol.
49	TACACS	AAA	Bidirectional traffic between TACACS server and GigaVUE-FM	Used for communicating with the authentication server in order to determine if you have access to the network.
22	TCP	SSH	Bidirectional traffic between Putty and GigaVUE-FM	Used for GigaVUE-FM admin user login. Also, used for initial GigaVUE-FM IP configuration. Used by the web browser to communicate with GigaVUE-VM for troubleshooting purposes.
514	TCP	Logstash	Unidirectional traffic from physical nodes to GigaVUE-FM	Used for sending device log messages via SSL from devices to GigaVUE-FM.

Port Number	Protocol	Service	Traffic Direction	Description
5672	TCP	RabbitMq	Unidirectional traffic from physical nodes to GigaVUE-FM	Used for sending event notifications via SSL from devices to GigaVUE-FM.
5671	TCP/SSL	RabbitMq	Unidirectional traffic from physical nodes to GigaVUE-FM	Used for sending event notifications via SSL from devices to GigaVUE-FM.
53	UDP	DNS	Bidirectional traffic between a DNS server and GigaVUE-FM	Used to resolve Fully Qualified Domain Names (FQDNs).
68	UDP	DHCP	Bidirectional traffic between GigaVUE-FM and DHCP server	Used only if DHCP is enabled on the GigaVUE-FM appliance.
123	UDP	NTP	Bidirectional traffic between a Network Time Protocol (NTP) server and GigaVUE-FM	Used only if GigaVUE-FM is configured to use NTP.
162	UDP	SNMP	Unidirectional traffic from managed appliances to GigaVUE-FM	Used to process incoming traps sent from managed appliances to GigaVUE-FM.
2055	UDP	NetFlow	Unidirectional traffic from managed Appliances to GigaVUE-FM	Used for receiving NetFlow traffic.

NOTE: For migration and provisioning purposes, Port 902 must be open between the VMware vCenter server and the VMware ESXi hosts. Otherwise, GigaVUE-FM bulk deployment fails.

Port Number	Protocol	Service	Traffic Direction	Description
902	TCP/UDP	ESXi Host	Bidirectional traffic between VMware vCenter and ESXi hosts	Used for sending data from vCenter Server to the ESXi host. The ESXi host uses this port to send regular heartbeat to the vCenter Server system.

The following table lists the open ports in GigaVUE-H series devices. GigaVUE-FM manages the devices using these open ports.

Table C-2: Open Ports in GigaVUE-H series Devices

Port Number	Protocol	Service	Traffic Direction	Description
22	SSH	Device Management	Bidirectional traffic between GigaVUE-FM and devices.	Used for image download, configuration backup/restore operations
80	HTTP	Communication	Bidirectional traffic between GigaVUE-FM and devices.	Used for initial communication setup. Assumption is that HTTP redirect will be turned ON in all GigaVUE devices and FM will use HTTP(S) henceforth

The following table lists the open ports in GigaVUE-G series devices. GigaVUE-FM manages the devices using these open ports.

Table C-3: Open Ports in GigaVUE-G Series Devices

Port Number	Protocol	Service	Traffic Direction	Description
22	SSH	Device Management	Bidirectional traffic between GigaVUE-FM and devices.	Configuration backup/restore operations
80	HTTP	Communication	Bidirectional traffic between GigaVUE-FM and devices.	Used for initial communication setup. Assumption is that HTTP redirect will be turned ON in all GigaVUE devices and FM will use HTTP(S) henceforth
443	HTTPS	Communication	Bidirectional traffic between GigaVUE-FM and devices.	GigaVUE-FM to device communication

Health Status

This appendix provides the health status information of the following:

- Node Health Status
- Port Health Status
- Map Health Status
- GigaSMART Map Health Status
- Flow Health Status

Node Health Status

The status of a node is determined by the health status of the following components:

- Ports
- Cards
- Fan Trays
- Power Modules
- Memory utilization
- CPU utilization

The health of a port and a fan depends on the health status of its associated components. For example, the health of a card depends on the port health. If more than 50% of the ports in a card are up and the operational status of the card is also up, then the card is determined as healthy (green). Similarly, the health of a fan depends on the operational status of the fan tray.

NOTE: GigaVUE-FM computes the health status of the node based on FanChange and PowerChange traps and the same is reflected in GigaVUE-FM GUI. The card health status is computed based on ModuleChange trap and the same is reflected in GigaVUE-FM GUI.

A node is considered unhealthy if:

- at least 50% of the cards are down
- at least 50% of the ports in a card are down
- at least 1 power module is down
- the average memory usage over the past one hour is more than 70%
- the CPU load per core is more than 50% overloaded

The change in the health status of a node is indicated in Events.

The cluster health is determined by the health status of the devices associated to the cluster.

The health status of a node is indicated by the following colors:

Color	Health Status
Green	Up (connected, healthy)
Amber	Warning


Color	Health Status
	This state is displayed when the operational status of the card is up and 50% of the associated ports are up.
Red	Down (disconnected), unreachable
Gray	Unknown This state is displayed when newly added nodes are yet to be discovered by GigaVUE-FM.

Port Health Status

The health of a port is determined by multiple factors:

- Operational status
- Packet drops (Optional)
- Packet errors (Optional)

GigaVUE-FM computes the health status of a port and its associated logical components such as Map when a port link changes. When a port flaps, GigaVUE-FM computes the health status and the same is reflected immediately in GUI.

Click  on the top navigation bar. On the left navigation pane, select **System > Traffic Health Thresholds**. The packet drops and errors are enabled by default for computing the health status of a port. For information about setting traffic health thresholds, refer to the *"Traffic Health Thresholds"* section in the *GigaVUE-OS and GigaVUE-FM Administration Guide*.

In this example, the Port Packet Drops and Port Packet Errors are enabled. The threshold value is set to 15000 packets over a time interval of 15 min. Refer to the following table to view how the port health status is calculated.

Color	Health Status	Operational Status	Packet Drops over 15 min	Packet Errors over 15 min
Green	Up (healthy)	Up	< 15000	< 15000
Red	Down (unhealthy)	Down	< 15000	< 15000
Red	Down (unhealthy)	Up	< 15000	> 15000
Red	Down (unhealthy)	Up	> 15000	> 15000
Red	Down (unhealthy)	Up	> 15000	> 15000

Inline Networks

The health of an inline network port depends on the forwarding state of the inline networks. GigaVUE-FM checks the forwarding state every 5 min. Refer to the following table to view how the health status of the inline network port is calculated.

Color	Health Status	Forwarding State
Green	Up (healthy)	Normal
Red	Down (unhealthy)	Failure-introduced Drop
Red	Down (unhealthy)	Network Ports Forced down
Red	Down (unhealthy)	DISCONNECTED
Red	Down (unhealthy)	ABNORMAL
Amber	Warning	Failure - Introduced Bypass
Amber	Warning	Forced Bypass with Monitoring
Amber	Warning	Disabled
Amber	Warning	Forced Bypass

Map Health Status

The health of a map is determined by the health status of its associated components such as ports, port groups, port pairs, GigaStream, tool port, GigaSMART group, tunneled port, virtual port, inline network, inline tool, inline tool group, inline serial tool group, inline network group, and GigaSMART operations. If the status of any one of the component is down, the corresponding map is considered unhealthy.

If a user creates/edits a Map through GigaVUE-FM, then those changes are reflected immediately to other users who are viewing the Map List View.

The health status of a map is indicated by the following colors:

Color	Health Status
Green	Up (healthy)
Amber	Warning This state is displayed when one or more ports associated to the map are unhealthy.
Red	Critical (unhealthy)
Gray	Unknown

NOTE: If you hover your mouse over the **Map Status** field, the health of the stack GigaStream or stack port (configured in the stack link) or the source and destination ports is displayed in a tooltip (if ports are unhealthy). You can derive the map health status based on the details displayed in the tooltip.

GigaSMART Map Health Status

The health of a GigaSMART map is determined by the health of the following components:

- All GigaSMART engine ports in the GigaSMART group (gsgroup)
- Virtual ports (vport) associated with the GigaSMART group
- GigaSMART operations
- IP Interfaces

Refer to the following table to view the health status of a map with GigaSMART:

Color	Health Status	GigaSMART Group	vPort	GigaSMART Operations	IP Interfaces
Green	Up	Up	Up	Up	Up
Red	Down	Up	Down	Up	Up
Red	Down	Up	Up	Down	Up
Red	Down	Up	Up	Up	Down
Red	Down	Down	Down	Down	Down

GigaSMART Group Health Status

The health of a GigaSMART group (gsgroup) depends on the aggregated health of the associated GigaSMART engine ports. The following components contribute to the health of the GigaSMART engine ports:

- **Operational Status**—The operational status of the associated GigaSMART engine ports. If the operational status of any GigaSMART engine port in the GigaSMART group is down, then the GigaSMART group becomes unhealthy.
- **GigaSMART Engine Port Packet Correlation**—The percentage (%) of packet correlation seen in a GigaSMART engine port. The GigaSMART engine packet correlation is calculated based on the following factors:
 - the cumulative number of packets coming into a GigaSMART group
 - the cumulative number of packets going out of a GigaSMART interface
 - the cumulative number of packets dropped at a GigaSMART operation for a map

If the number of packets going out of a GigaSMART interface exceeds the threshold set in **Administration > System > Traffic Health Thresholds**, the GigaSMART engine port becomes unhealthy.

- **GigaSMART Engine Port Packet Drops**—The cumulative number of packets dropped due to over subscription of a GigaSMART engine port. If the number of GigaSMART engine port packet drops exceed the threshold set in **Administration > System > Traffic Health Thresholds**, then the GigaSMART engine port becomes unhealthy.
- **GigaSMART Engine Port Packet Errors**—The cumulative number of packet errors coming into a GigaSMART engine port. If the number of GigaSMART engine port packet errors exceed the threshold set in **Administration > System > Traffic Health Thresholds**, then the GigaSMART engine port in the GigaSMART group becomes unhealthy.

For information about setting traffic health thresholds, refer to the *"Traffic Health Thresholds"* section in the *GigaVUE-OS and GigaVUE-FM Administration Guide*. All threshold types are enabled by default for computing the health status of the GigaSMART engine ports.

In this example, the thresholds are enabled and the threshold values are set as follows:

Type	Threshold Value	Interval
GigaSMART engine port packet correlation	50	15
GigaSMART engine port packet drops	15000	15
GigaSMART engine port packet errors	15000	15

Refer to the following table to view how the GigaSMART engine port health status is calculated.

Color	Health Status	Operational Status	Packet Correlation	Packet Drops over 15 min	Packet Errors over 15 min
Green	Up (healthy)	Up	< 50	< 15000	< 15000
Red	Down (unhealthy)	Down	-	-	-
Red	Down (unhealthy)	Up	> 50	< 15000	< 15000
Red	Down (unhealthy)	Up	< 50	> 15000	< 15000
Red	Down (unhealthy)	Up	< 50	< 15000	> 15000

The GigaSMART group health status is determined by the aggregated health of the GigaSMART engine ports. Refer to the following table for computing the health of a GigaSMART group:

Color	GigaSMART Group Health	GigaSMART Engine Ports
Green	Up	Up
Amber	Warning	Some engine ports are down
Red	Down	All engine ports are down

vPort Health Status

GigaSMART virtual port is used as an aggregation point for traffic directed to second level maps. Second level maps include an Adaptive Packet Filtering component or a GTP rule.

A vPort is healthy when the GigaSMART group associated with the vPort is healthy. If a gsgroup is unhealthy and the vPort is healthy, this indicates that the vPort is not participating in the maps.

GigaSMART Operations Health Status

GigaSMART Operation consists of one or more advanced processing applications.

A GigaSMART operation (gsop) is healthy when the GigaSMART group associated with the gsop is healthy. If a gsgroup is unhealthy and the gsop is healthy, this indicates that the gsop is not participating in the maps.

IP Interfaces Health Status

IP interfaces are used for GigaSMART encapsulation and decapsulation operations on both network ports and tool ports.

An IP interface is healthy when the GigaSMART group associated with the IP interface is healthy. If a gsgroup is unhealthy and the IP interface is healthy, this indicates that the IP interface is not participating in the maps.

For information on how to calculate the map health, refer to [Map Health Status](#).

Flow Health Status

The health of a flow is determined by the aggregated health of the maps in the flow. The factors that determine the health of a flow is as follows:

- Health of the priority maps in the flow
- Health of the maps that constitute the priority map set
- Gigamon Discovery or Manual links

Priority Map Set Health

A priority map set consists of more than one map configured with the same source ports in priority order. The health of such map is determined by the aggregated health of the constituted maps. For information about how map health is computed, refer to [Map Health Status](#).

The following table provides a summary of the health status of a map chain:

Color	Priority Map Set Health Status	Maps in the Map Chain
Green	Healthy	All maps are healthy
Amber	Warning	One or many maps in warning state
Red	Unhealthy	One or many maps in unhealthy state

Flow Health Computation

Starting with software version 5.4, the current throughput percentage used in determining the health of a tool device would be determined as follows:

Current Throughput %	Tool Health	Reasons
<85	Green	All maps are healthy
>85 && <100	Yellow	>85 && <100 Yellow Tool device is experiencing throughput between 85% to 100%
>100	Red	One or many maps in unhealthy state

Based on the tool device health, flow health for the flows having tool device would be computed as follows:

Existing Flow Health	Tool Health	New Flow health	Reasons
Red	Red/Yellow/Green	Red	Existing Flow Health reasons + tool health reasons
Yellow	Red	Red	Existing Flow Health reasons + tool health reasons
Yellow	Yellow	Yellow	Existing Flow Health reasons + tool health reasons
Yellow	Green	Yellow	Existing Flow Health reasons
Green		Red	Tool health reasons
Green	Warning	One or many maps in warning state	Tool health reasons
Green	Green	Green	--

GigaVUE-FM APIs

GigaVUE-FM APIs are designed with the Representational State Transfer (REST) architecture, which provides a well structured architecture for performing query, update, and delete functions in a programmatic manner. GigaVUE-FM APIs are implemented based on Open API 3.0 specification (formerly known as Swagger) and conform to required standards.

Topics:

- [Introduction and Concepts](#)
- [GigaVUE-FM API Workflows](#)
- [Working with GigaVUE-FM APIs](#)

Introduction and Concepts

The REST APIs make it possible to create client applications that are platform-and-language-independent. REST applications can use the APIs to perform various tasks with GigaVUE-FM by making requests and receiving responses as shown in [Figure 1: APIs and GigaVUE-FM](#).

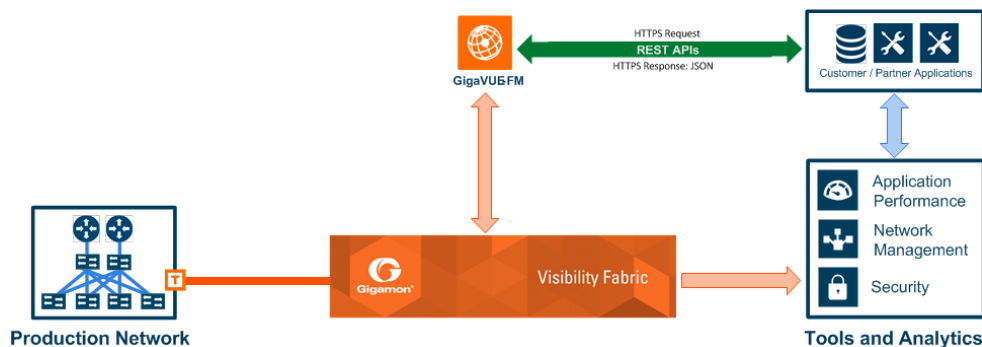


Figure 1: APIs and GigaVUE-FM

Applications that implement the GigaVUE-FM APIs can do the following:

- Improve security through better network detection, reaction, and response by automating NetFlow generation and SSL decryption so that current security appliances are not overtaxed when performing deep packet inspection. For example, security administrators can use the APIs that program the Visibility Fabric to dynamically change the traffic forwarding policies in response to threats or anomalous network traffic changes.
- As new virtual machines are spun up, administrators can write policy management programs that utilize Gigamon's APIs to automatically follow new changes within virtual and physical networks.
- For many organizations, IT Operations Management (ITOM) groups can use the APIs to develop programs that automate the following processes through software-defined visibility:

- Performing common tasks, such as provisioning and ticketing of network port configurations.
- Monitoring new IP subnets and VLANs.
- Upgrading software images.

Refer to the following sections:

- [Installation](#)
- [What is REST?](#)
- [Authentication](#)
- [Resources](#)
- [GigaVUE-FM Resources](#)
- [HTTP](#)
- [GigaVUE-FM API Reference](#)

Installation

For support and installation instructions, refer to the *GigaVUE-FM and GigaVUE Cloud Suite for VMware Configuration Guide*.

What is REST?

REST is an architectural style that relies on a client-server communication protocol that is stateless. It is assumed that the client and server do not know anything about the state of an object other than what is communicated in requests and responses. Objects are identified by a uniform resource identifier (URI). Objects represent resources, and the URI provides a link to the resource. The state of a resource is communicated by structured documents passed between the client and the server.

GigaVUE-FM APIs use HTTP as the communication protocol to communicate with the GigaVUE Fabric Manager (FM). Therefore, anyone who is creating applications should be familiar with the HTTP protocol before creating clients that use the APIs.

Another important concept is Hypermedia as the Engine of State (HATEOS). HATEOS is a constraint on the REST architecture. This constraint states that hypertext is used to change the state of an application and allows the application to navigate through an API.

Authentication

Authentication must accompany each request that an application makes to GigaVUE-FM. The authentication is contained in the authorization header of the request. (For more information about headers, refer to [HTTP Headers](#).) The APIs only support Basic authorization. Basic authorization uses unencrypted base64 encoded text to send the user name and password in the request.

The following is an example of using base64 encoding to encode a user name and password:

```
encoding = base64.base64encode('username1:password1')
print encoding
dXN1cm5hbWU6cGFzc3dvcmQ=
```

Notes:

- When an application logs in to GigaVUE-FM to make a request, the application should also log out after the request is complete. Otherwise, too many user sessions may be created and an invalid credential error message returned if the current request exceeds the maximum number of user sessions.
- Starting with GigaVUE-OS 4.7.00, the default admin password admin123A! is no longer allowed on nodes. When authenticating through the APIs against a node that is running GigaVUE-OS 4.7.00 or later, if admin123A! is used, the authentication will not complete.

Resources

Resources are a key component in REST and represent an object within a system. They are associated with data and have relationships to other resources. There is also a set of methods that operate on a resource.

The following sections provide an overview of these resources and the resources an application can access through GigaVUE-FM:

- [Links to Resources](#)
- [Representation of Resources](#)
- [JSON Representation](#)
- [HTTP Headers](#)
- [HTTP Methods](#)

Links to Resources

A uniform resource identifier (URI) provides the link to a resource. The URI consists of a base URI and a request URI. The base URI for GigaVUE-FM APIs is as follows, where **<fmip>** is the IP address for GigaVUE-FM and **<api_version>** is the current version of the API:

<fmip>/api/<api_version>

The request URI is the portion of the URI used to perform an HTTP request. For example:

/inventory/ports

A complete URI is:

<fmip>/api/v1.3/inventory/ports

NOTE: You can use the API GET **<fmip>/api/version** to get the current API version. This API returns the following content in JSON format:

```
{"apiVersion": "v1.3", "schemaVersion": "v1.3"}
```

Representation of Resources

GigaVUE-FM REST APIs use JavaScript object notation (JSON) to represent resources in a structured document. This representation is used in the request and response bodies of API calls. The default format is JSON and the *GigaVUE-FM API Reference* provides JSON models and model schema to describe response classes and request bodies. For information on how to access the reference, refer to [GigaVUE-FM API Reference](#).

When a client makes a request to a resource, the request specifies that it is using JSON in the request and that the response should return data in JSON. The format is specified in the header of the request. For more information about headers, see [HTTP Headers](#)

JSON Representation

JSON is a language-independent data format that is considered easy to read and write. The data is provided as a collection of unordered name/value pairs and ordered lists of values. The name/value pairs can be viewed as a dictionary and the ordered list of values as an array.

For example, the following represents port information in JSON format returned in a response body as the result of a query to the resource **/inventory/ports**:

```
{
  "context" : {
    "totalItems" : 59
  },
  "ports" : [ {
    "portId" : "5/2/x4",
    "comment" : "",
    "portType" : "tool",
    "adminStatus" : "down",
    "operStatus" : "down",
    "licensed" : true,
    "medium" : "OPTICAL",
    "configSpeed" : "10G",
    "duplex" : "full",
```

```

        "autoNeg" : false,
        "forceLinkUp" : false,
        "mtu" : 9600,
        "healthState" : "green",
        "neighborDiscovery" : "none"
    }, {
        "portId" : "5/2/x12",
        "comment" : "",
        "portType" : "network",
        "adminStatus" : "down",
        "operStatus" : "down",
        "licensed" : true,
        "medium" : "OPTICAL",
        "configSpeed" : "10G",
        "duplex" : "full",
        "autoNeg" : false,
        "forceLinkUp" : false,
        "mtu" : 9600,
        "healthState" : "green",
        "neighborDiscovery" : "none"
    }, ...
    ]
}

```

Because the data can be viewed as dictionaries and arrays, it is easy to extract the information from a response. For example, the following code processes the JSON document and prints the administrative and operational status of ports with an administrative status of *up*:

```

portInfo = json.loads(r.text)
ports = portInfo['ports']
for port in ports:
    adminStatus = port['adminStatus']
    operStatus = port ['operStatus']
    if adminStatus == 'up':
        print 'Port ID: ' + port['portId']
        print '  Admin Status: ' + port['adminStatus']
        print '  Op Status: ' + port['operStatus']

```

In JSON, the collection of name/value pairs is referred to as an object, and the ordered collection of values is referred to as an array. In the previous code example, the **json.loads** function converts the JSON object into a dictionary.

Values are separated by commas and can be any of the following:

- A string in double quotes
- A number
- An object
- An array
- True

- False
- Null

XML Representation

REST APIs can also use XML formatted documents in request bodies and in responses. In an XML representation, the resource is represented as elements and attributes.

The following snippet represents the same port information shown in the previous section. However, it is presented in XML format instead of JSON.

```
<?xml version="1.0" encoding="UTF-8" standalone="yes"?>
<?xml version="1.0" encoding="UTF-8" standalone="yes"?>
<GigaPortsQueryResponse>
  <context>
    <totalItems>59</totalItems>
  </context>
  <ports>
    <port portId="5/2/x4">
      <comment></comment>
      <portType>tool</portType>
      <adminStatus>down</adminStatus>
      <operStatus>down</operStatus>
      <licensed>true</licensed>
      <medium>OPTICAL</medium>
      <configSpeed>10G</configSpeed>
      <duplex>full</duplex>
      <autoNeg>>false</autoNeg>
      <forceLinkUp>>false</forceLinkUp>
      <mtu>9600</mtu>
      <healthState>green</healthState>
      <neighborDiscovery>none</neighborDiscovery>
    </port>
    <port portId="5/2/x12">
      <comment></comment>
      <portType>network</portType>
      <adminStatus>down</adminStatus>
      <operStatus>down</operStatus>
      <licensed>true</licensed>
      <medium>OPTICAL</medium>
      <configSpeed>10G</configSpeed>
      <duplex>full</duplex>
      <autoNeg>>false</autoNeg>
      <forceLinkUp>>false</forceLinkUp>
      <mtu>9600</mtu>
      <healthState>green</healthState>
      <neighborDiscovery>none</neighborDiscovery>
    </port>
    ...
  </ports>
</GigaPortsQueryResponse>
```

The following code processes the XML document and prints the administration and operation status of ports with an administration status of "up".

```

root = ET.fromstring(r.text)

for port in root.iter('ports'):
    for port in ports.findall('port'):
        portId = port.get('portId')
        adminStatus = port.find('adminStatus').text
        operStatus = port.find('operStatus').text
        if adminStatus == 'up':
            print 'Port ID: ' + portId
            print ' Admin Status: ' + adminStatus
            print ' Op Status: ' + operStatus

```

GigaVUE-FM Resources

The GigaVUE-FM APIs provide much of the same functionality as the GigaVUE-OS CLI commands. [Table 1: API Resources and CLI Commands](#) lists the available resources by their root and the CLI commands that provide a similar functionality as the APIs for a given resource. (For detailed information about the CLI commands, refer to the *GigaVUE-OS-CLI Reference Guide*. The base URI for the resources when making a request is `<fmip>/api/v3.1`. For more information about URIs, refer to [Links to Resources](#).

Table 1: API Resources and CLI Commands

Resource	Description	CLI Command
/nodes	Node management	FM only
/nodeCredentials	Credentials for FM managed physical nodes	FM only
/inventory/chassis	Device chassis configuration	show chassis
/inventory/ports	Device port configuration	show port
/portConfig/portConfigs	Port configuration	port
/portConfig/portGroups	Port group configuration	port-group
/tunnelLBEndpoints	Tunnel Endpoint operations	
/portConfig/gigastreams	GigaStream configuration	gigastream
/portConfig/portPairs	Port-pair configuration	port-pair
/portConfig/toolPortMirrors	Tool port mirror configuration	tool-mirror
/portConfig/toolPortFilters	Tool port filter configuration	port filter rule
/portConfig/stackLinks	Stack links configuration	stack-link

Resource	Description	CLI Command
/portConfig/tunneledPorts	Tunneled port configuration	tunneled-port
/maps	Maps and map rules configuration	map
/mapChains	Map chain configuration	FM only
/mapGroups	Map group configuration	
/mapTemplates	Map template configuration	map-template
/filterTemplates	Filter template configuration	
/gigasmart	GigaSMART engine configuration	
/gsGroups	GigaSMART group configuration	gsgroup
/gsops	GigaSMART operations configuration	gsop
/vports	Virtual port configuration	vport
/apps/netflow	Netflow exporter, record, and monitor configuration	apps netflow
/apps/ssl	Secure Socket Layer (SSL) decryption keystore and decryption key configuration	apps ssl
/apps/saApfProfiles	Session-aware APF profile configuration	apps sapf
/apps/gtp/whitelists	GTP Whitelist operations	apps gtp-whitelist
/inline/networks	Inline network configuration	inline-network
/inline/networkGroups	Inline network group configuration	inline-network-group
/inline/tools	Inline tool configuration	inline-tool
/inline/toolGroups	Inline tool group configuration	inline-tool-group
/inline/serialToolGroups	Inline tool series configuration	inline-serial
/inline/hbProfiles	Heartbeat profile configuration	hb-profile
/inline/negativeHbProfiles	Negative heartbeat profile configuration	inline-tool negative-heart-beat
/inline/hbPackets	Heartbeat packet upload configuration	hb-profile custom-

Resource	Description	CLI Command
		packet hb-profile packet-format
/inline/reduncancyProfiles	Inline tool group redundancy	inline-network
/system/config	Configuration files upload and download	configuration fetch configuration upload
/system/time	Time settings	ntp, ptp
/system/syslog	Syslog retrieval and update	logging
/system/sysdump	Sysdump file generation, download, and delete	debug generate dump
/system/diag	Retrieves the diagnostic info about the device like build version, software version, port configuration, and so on.	
/system/localUsers	Local user account management	username
/system/security	System security policy settings	system
/system/aaa	Authorization and roles	aaa authentication
system/ldapServers	LDAP servers for authentication	ldap
/system/radiusServers	RADIUS servers for authentication	radius-server
/system/tacacsServers	TACACS+ servers for authentication	tacacs-server
/system/snmp	SNMP settings, v3 users, notification targets	snmp-server host
/system/email/notifications	Email notification settings	email
/system/uboot	Install binary bootloader code included with the active/booted image	uboot install
/clusterConfig	Physical cluster reboot and image upgrade	reload
/system/interfaces	Retrieves system interface information	show interface

Resource	Description	CLI Command
/clusterConfig/backup	Cluster configuration backup and restore	
/clusterConfig/bulk	Bulk replicate configuration	
/imageServers	Image file servers	FM only
/licensing	Licensing management for FM	FM only
/events	Manage events	FM only
/auditLog	Audit log of user actions on FM	FM only
/trending	Time series information for ports, maps, GS groups, virtual ports, GVM ports, and GVM maps	FM only
/trafficAnalyzer	Flow mapping analytics for dropped traffic	FM only
/tunnelEndpoints	Tunnel endpoint information	tunneled-port
/topology	Create, update, and delete manual nodes and links in Topology Visualization	FM only
/fmSystem	Reboot, backup, and restore GigaVUE-FM. Provide the image server and file path to the upgrade image on the server.	FM only
/fmSystem/archiveServers	Manage archive server and archive files.	FM only

Starting with GigaVUE-FM 3.5, Public Cloud Visibility APIs are available for use with the Gigamon Visibility Platform for AWS. These resources do not have any equivalent CLI commands. [Table 2: Gigamon Visibility Platform for AWS API Resources](#) lists the resources for Public Cloud Visibility. For details about these APIs, refer to the *GigaVUE-FM 3.5 API Reference*.

Table 2: Gigamon Visibility Platform for AWS API Resources

Resource	Description
vfm/configParams	Retrieves and redefines configuration parameters.
vfm/proxyServers	Creates, updates, and deletes Proxy Servers
vfm/tunnelSpecs	Retrieves, creates, modifies, or deletes tunnel specification.
vfm/tunnelEndpoints	Retrieves tunnel endpoints.
vfm/maps	Retrieves, creates, modifies, or deletes maps.
vfm/mapFolders	Retrieves, creates, modifies, or deletes map folders and retrieves maps associated with a folder.

Resource	Description
vfmm/apps	Retrieves, registers, updates, or deletes GigaSMART applications.
vfmm/monitoringSessions	Retrieves, creates, modifies, or deletes monitoring sessions.
vfmm/statistics	Retrieves monitoring session traffic statistics.
vfmm/ats/	Retrieves a list of VMs selected for a monitoring session.
vmm/aws/connections	Retrieves, updates, adds, or connects to AWS connections.
vfmm/aws/fabricDeployment	Manages AWS fabric deployment, G-vTAP Controllers, V Series Controllers, and V Series nodes
vfmm/openstack/connections	Retrieves, adds, updates, and removes OpenStack Connection details.
vfmm/openstack/fabricDeployment	Manages OpenStack fabric deployment that includes G-vTAP Controllers, V Series Controllers, and V Series nodes.

HTTP

The Hypertext Transfer Protocol (HTTP) is the protocol used in REST for communication between the client and the server. This section provides a description of the HTTP methods supported by the GigaVUE-FM APIs, HTTP headers, and status codes that can be returned in response to a request.

This section covers the following topics:

- [HTTP Headers](#)
- [HTTP Methods](#)
- [HTTP Status Codes](#)

HTTP Headers

HTTP headers are part of requests and responses and provide information about the client and the server. The headers contain authorization information and specify the format of the content in a request or response body.

The following are the basic headers:

- **Authorization**—Specifies the authentication used in the request. Basic authorization sends the user name and password as unencrypted base64 encoded text. Digest authorization sends the password to the server in a hashed form. (The GigaVUE-FM APIs use only Basic authorization.)
- **Accept**—Specifies the format of the data expected in the response to a request.
- **Content-Type**—Specifies the format of the data in a request or response body. This header is used in POST, PUT, and PATCH operations. It is not used with a GET operation.

- Content-Length—Specifies the number of bytes in the content body of a request.

NOTE: In the current release, the Content-Type and Accept headers should always specify **application/json**.

HTTP Methods

REST applications use HTTP methods to perform create, read, update, and delete operations on resources, otherwise known as CRUD operations. The GigaVUE-FM REST APIs support the following HTTP methods:

- GET
- POST
- PUT
- PATCH
- DELETE

These operations are idempotent. In the context of REST, this means that the same request always produces the same result on the server. However, the response from the server may be different because it may have changed state between requests.

GET

A **GET** operation requests a resource for a representation of that resource. GET requests only retrieve data.

The following example retrieves a port by port ID:

```
GET <fmip>/api/<api_version>/inventory/ports/5_2_x8
Authorization: Basic 'dXNlcm5hbWU6cGFzc3dvcmQ='
Accept: application/json
```

The previous request returns the following response in JSON format:

```
{
  "port" : {
    "portId" : "5/2/x8",
    "alias" : "Map_Source",
    "comment" : "",
    "portType" : "network",
    "adminStatus" : "up",
    "operStatus" : "up",
    "licensed" : true,
    "medium" : "OPTICAL",
    "sfp" : {
      "sfpType" : "sfp+ sr",
      "sfpPower" : " -1.86 ",
      "vendorName" : "GIGAMON SFP-532",
```

```

        "vendorSn" : "APM0M2D          ",
        "vendorPn" : "GMON8571D3BCL-G"
    },
    "configSpeed" : "10G",
    "duplex" : "full",
    "autoNeg" : false,
    "forceLinkUp" : false,
    "mtu" : 9600,
}
}

```

POST

A **POST** operation creates a new resource. The resource is created at the location specified in the request. For example, the following request adds a GigaSMART operation at `/api/<api_version>/gsops`:

```

POST <fmip>/api/<api_version>/gsops?clusterId=10.115.152.54
Authorization: Basic 'dXNlcm5hbWU6cGFzc3dvcmQ='
Content-Type : application/json
Accept : application/json
Content-Length : 129

```

The following is an example of a body used in the previous request:

```

{
  "alias" : "masking",
  "gsGroup" : "GS1",
  "gsApps" : {
    "masking" : {
      "protocol" : "tcp",
      "offset" : 4,
      "pattern" : "b" ,
      "length" : 13
    }
  }
}

```

PUT

A **PUT** operation modifies a resource with data provided in the request. The resource is created with the given data at the URI in the request if the resource does not already exist.

For example, the following request replaces an existing map definition defined by its alias.

```

PUT <fmip>/api/<api_version>/maps/AASlice_Level1
Authorization: Basic 'dXNlcm5hbWU6cGFzc3dvcmQ='
Content-Type : application/json
Accept: application/json
Content-Length : 597

```

The following is an example of a body used in the previous request:

```

{
  "maps" : [ {

```

```

    "alias" : "AASlice_Level1",
    "clusterName" : "10.115.152.54",
    "type" : "firstLevel",
    "subType" : "byRule",
    "srcPorts" : [ "10/1/g10", "10/1/g11", "10/1/g12", "10/1/g13"],
    "dstPorts" : [ "vp" ],
    "order" : 1,
    "rules" : {
      "dropRules" : [ ],
      "passRules" : [ {
        "ruleId" : 1,
        "bidi" : true,
        "matches" : [ {
          "type" : "portSrc",
          "value" : 80
        } ]
      } ],
      {
        "ruleId" : 2,
        "bidi" : true,
        "matches" : [ {
          "type" : "portSrc",
          "value" : 20
        } ]
      },
      {
        "ruleId" : 3,
        "bidi" : true,
        "matches" : [ {
          "type" : "portSrc",
          "value" : 21
        } ]
      } ]
    },
    "roles" : {
      "owners" : [ "admin" ],
      "viewers" : [ ],
      "editors" : [ ],
      "listeners" : [ ]
    }
  } ]
}

```

PATCH

A PATCH operation modifies individual properties of a resource according to the instructions in the request.

For example, the following request changes a tool port to a network port and enables the administrative status:

```

PATCH <fmip>/api/<api_version>/inventory/ports/3_1_x1
Authorization: Basic 'dXNlcm5hbWU6cGFzc3dvcmQ='

```

```
Content-Type: application/json
Accept: application/json
Content-Length : 62
```

The following is an example of the body used in the previous request:

```
{
  'adminStatus': 'up',
  'portType': 'network',
  'portId': '3/1/x1'
}
```

DELETE

A DELETE operation removes a resource.

For example, the following request deletes a map by its alias:

```
DELETE <fmip>/api/<api_version>/maps/AASlice_Level1
Authorization: Basic 'dXNlcm5hbWU6cGFzc3dvcmQ='
Content-Type: application/json
Accept: application/json
```

HTTP Status Codes

A response to a request provides a status code indicating to the client whether the request was successful or failed. [Table 3: HTTP Status Codes](#) lists some of the status codes that the GigaVUE-FM APIs can return.

Table 3: HTTP Status Codes

Status Code	Meaning
200 OK	The request succeeded.
201 Created	The request was accepted and a new resource was created.
202 Accepted	The server accepted the request.
204 No Content	The response did not have any content.
400 Bad Request	The request is invalid.
401 Unauthorized	The request was not authenticated.
403 Forbidden	Access denied.
404 Not Found	The entity was not found.
409 Conflict	The entity already exists.
500 Internal Server	An error occurred on the server.

For 400 and 500 series status codes, the response from GigaVUE-FM contains a body in JSON format that provides a description of the error.

GigaVUE-FM API Reference

You can access the descriptions of the GigaVUE-FM Core APIs from GigaVUE-FM by clicking on the appropriate link under **Support**. The help page lists the APIs for the different types of operations. Each description provides the methods available, the JSON model and model schema for the requests and responses, and the applicable HTTP status codes returned in error messages. You can also connect to the on-line *GigaVUE-FM API Reference* through the following URL:

<FM IP address>/apiref/apiref.html

Response Error Messages

Starting with GigaVUE-FM version 3.4, REST API requests return a global error message if an error occurs. Prior to GigaVUE-FM version 3.4, if an error occurred the error message presented was the error returned by the device, which could vary from device to device for the same error condition. The global error message returned by GigaVUE-FM APIs have an error response body that contains a unique code and a message. The following is an example:

```
"errors":
[{"code": "0x800200b",
  "msg": "Invalid alias 'Test Space'. ' ' is a reserved character."
}]
```

The following tables list the possible error codes and their descriptions.

Table 4: Gigamon Device Error Codes

Error Code	Description
0x80020000	initialization failure
0x80020001	TMS internal failure
0x80020002	Null Objects
0x80020003	No more resource
0x80020004	uninitialized param
0x80020005	Unsupported Product Code
0x80020006	Unsupported Operation
0x80020007	Configuration Failed
0x80020008	Configuration exists

Error Code	Description
0x80020009	Configuration not found
0x8002000a	Operation not allowed on reserved object
0x8002000b	invalid argument
0x8002000c	invalid net addr/mask
0x8002000d	invalid ip addr/mask
0x8002000e	GV DB query failed
0x8002000f	GVO internal failure
0x80020010	Objects exceeds maximum range
0x80020011	Config in progress
0x80020012	User invalid
0x80020013	User role Invalid
0x80020014	User Permission Insufficient for Operation
0x80020015	Unlicensed Feature
0x80020016	Feature License expired
0x80020017	Chassis is in SAFE mode! No new traffic configuration is allowed.
0x80020018	Chassis is in LIMITED mode! The configuration is not allowed.
0x80020020	Chassis not valid
0x80020021	Card not valid
0x80020022	Card Mode Invalid
0x80020023	Slot not valid
0x80020024	Slot State Invalid
0x80020025	Slot not configured
0x80020026	Unconfigured box-id
0x80020027	Chassis mode is not supported
0x80020028	CC card does not support this card
0x80020030	Port Invalid
0x80020031	Port Type Invalid
0x80020032	Port not configured

Error Code	Description
0x80020033	Port Mode Invalid
0x80020034	Port Inactive
0x80020035	Port SFP Unsupported
0x80020036	Port Config is invalid
0x80020037	Port Config exists
0x80020038	Port conflict in config
0x80020039	Portpair update disallowed. Config exists
0x8002003a	Portpair object mismatch
0x8002003b	Portpair cross-box not supported
0x8002003c	Portpair cross-card not supported
0x8002003d	Portpair with tunnel not supported
0x8002003e	Portpair Linktimer failed
0x8002003f	Port Group in Use
0x80020040	Port Group Object Mismatch
0x80020041	Port Group has Tunnel config
0x80020042	Port Group resource exceeds range
0x80020043	Stacklink in Use
0x80020044	Stacklinks cannot be in same box
0x80020045	Stacklinks not found
0x80020046	Stacklinks will cause loops
0x80020047	Port in Use
0x80020048	Invalid port to break out
0x80020060	GSOP required for operation
0x80020061	GSOP SSL requires order of operation
0x80020062	GSOP invalid
0x80020063	GSOP invalid GSAPP combination
0x80020064	GSOP Configuration exists
0x80020065	GSOP object mismatch

Error Code	Description
0x80020066	GSOP AFP needs VPORT
0x80020067	GSOP and VPORT not in same group
0x80020068	GSOP and GSGroup mismatch
0x80020069	GSOP needs flow filter
0x80020070	GS:internal error
0x80020071	GS:gsrcule object mismatch
0x80020072	GS:gsrcule and flowrule mismatch
0x80020073	GS: no tunnel-port
0x80020074	GS: Tunnel Config exists
0x80020075	GS: Tunnel object mismatch
0x80020076	GS: Tunnel feature not supported
0x80020077	GS: Tunnel resource not available
0x80020078	GS: Tunnel incomplete config
0x80020079	GS:SSL Error
0x8002007a	GS:SSL app not found
0x8002007b	GSGROUP SSL passwd not set
0x8002007c	GS:SSL key error
0x8002007d	GS:SSL Max key object
0x8002007e	GS:SSL duplicate key object
0x8002007f	GS:SSL failed to decrypt key object
0x80020080	GS:SSL failed to decrypt key object
0x80020081	GS:SSL Server config exists
0x80020090	GSGROUP not valid
0x80020091	GSGROUP Filter has more e-ports
0x80020092	GSGROUP Max num or GSRULES exceeds
0x80020093	GSGROUP Config exists
0x80020094	GSGROUP object not found
0x80020095	GSGROUP object mismatch

Error Code	Description
0x80020096	GSGROUP Flow-sampling has more e-ports
0x80020097	GSGROUP Ports are not in same chassis
0x80020098	GSGROUP Netflow object mismatch
0x80020099	GSGROUP Netflow object not found
0x8002009a	GSGROUP Netflow feature not support on V9
0x80020100	GigaStream config exists
0x80020101	GigaStream config in use
0x80020102	GigaStream config object mismatch
0x80020103	GigaStream not on same resource or entity
0x80020104	GigaStream resource exceeds range
0x80020180	Invalid rule
0x80020181	MAP object mismatch
0x80020182	MAP Max num or RULES exceeds
0x80020183	MAP: Passall with map objects not allowed
0x80020184	MAP rules with collector not allowed
0x80020185	MAP invalid gsrules
0x80020186	MAP config exists
0x80020187	MAP config invalid
0x80020188	MAP: VPORT object mismatch
0x80020189	MAP: VPORT config exists
0x8002018a	MAP inline port-list invalid
0x8002018b	MAP inline port config exists
0x8002018c	MAP inline source in port-list
0x8002018d	MAP: gsop in inline not allowed
0x8002018e	MAP:app in inline not allowed
0x8002018f	MAP: VPORT in inline not allowed
0x80020190	MAP: inline destination conflict
0x80020191	MAP: inline source conflict

Error Code	Description
0x80020192	MAP invalid gsrules
0x80020193	GSOP apps require reboot to take effect
0x80020194	GSOP Duplicate SSL configuration
0x80020195	GS: Tunnel Exporter Config exits
0x80020196	GS: Exporter Alias not found
0x80030000	initialization failure
0x80030001	invalid argument
0x80030002	uninitialized param
0x80030003	Unsupported Product Code
0x80030004	incomplete port string
0x80030005	port not found
0x80030006	Unknown error
0x80050000	initialization failure
0x80050001	invalid argument
0x80050002	uninitialized param
0x80050003	Unsupported Product Code
0x80050004	Unknown error
0x80070000	initialization failure
0x80070001	invalid argument
0x80070002	uninitialized param
0x80070003	Unsupported Product Code
0x80070004	Unknown error
0x80090000	initialization failure
0x80090001	invalid argument
0x80090002	uninitialized param
0x80090003	Unsupported Product Code
0x80090004	Unknown error
0x800a0000	initialization failure

Error Code	Description
0x800a0001	invalid argument
0x800a0002	uninitialized param
0x800a0003	invalid param
0x800a0004	User provided buffer is NULL
0x800a0005	Stats Buffer Overflow(less that require buffer size)
0x800a0006	Port number out of Range
0x800a0007	Out of Range (Parameter)
0x800a0008	Unknown Stat type
0x800a0009	Provided History count does not match Stat type
0x800a000a	Stat Query: for Device failed
0x800a000b	Stat Query: send request timed out
0x800a000c	Stat Query: rcv request timed out
0x800a000d	Stat Query: remote node query failed
0x800a000e	Stat Query: remote node returned nothing
0x800b0000	initialization failure
0x800b0001	invalid argument
0x800b0002	uninitialized param
0x800b0003	Unsupported Product Code
0x800b0004	Unknown error
0x800c0000	initialization failure
0x800c0001	invalid argument
0x800c0002	uninitialized param
0x800c0003	invalid param
0x800c0004	incomplete port string
0x800c0005	invalid port type
0x800c0006	mod_id is out of range
0x800c0007	mod_id un-assigned
0x800c0008	box-id out of range

Error Code	Description
0x800c0009	slot-id out of range
0x800c000a	card-index out of range
0x800c000b	port not found
0x800c000c	Unknown error
0x800d0000	command terminated - not shown to the user.
0x800d0001	Unknown error
0x800e0000	ugw invalid request
0x800e0001	ugw session not authentication
0x800e0002	ugw access denied
0x800e0003	ugw entity no found
0x800e0004	ugw entity already exists
0x800e0005	ugw invalid cookie
0x800e0006	mgmtd internal error
0x800e0007	ugw not implemented
0x800e0008	Unknown error

Table 5: REST API Errors

Error Code	Description
0x800f0000	general: The requested URL was not found on this server
0x800f0001	general: Login failure
0x800f0002	general: Session ID not valid. No need to logout.
0x800f0003	general: Failed to connect to the unified gateway.
0x800f0004	general: The Content-Type is application/json but the request body is not valid JSON.
0x800f0005	general: Only application/json Content-Type is supported for this operation.
0x800f0006	general: JSON schema validation failed on request body
0x800f0007	general: No request body present. This operation requires a JSON request body.
0x800f0008	general: The request body is not valid JSON object. This operation requires a JSON object request body.

Error Code	Description
0x800f0009	general: Not implemented
0x800f000a	general: Unauthorized
0x800f000b	general: Forbidden
0x800f000c	general: Resource not found
0x800f000d	general: Incorrect alias
0x800f000e	general: Invalid alias
0x800f000f	general: Resource exists
0x800f0010	general: Invalid action
0x800f0011	general: Missing required param
0x800f0012	general: The page query parameter must be in the form '(pageNum:pageSize)'
0x800f0013	general: Invalid sort query
0x800f0014	general: Writing to a readonly property
0x800f0015	general: Cli error
0x800f0016	apps/netflow/exporter/filter: Bid/sid of valueMax must equal bid/sid of value
0x800f0017	apps/netflow/exporter/filter: Input port error
0x800f0018	apps/netflow/exporter/filter: Ipv6 requires a value for one of 'netMask' or 'valueMax'.
0x800f0019	system/snmp: Incorrect notif target address
0x800f001a	system/snmp: Incorrect username
0x800f001b	system/config/text: Username and password is required
0x800f001c	portConfig/portConfigs: Invalid port threshold
0x800f001d	portConfig/portConfigs: Invalid tool port
0x800f001e	mapChains: Incorrect map chain id
0x800f001f	inventory/chassis: Incorrect slotid
0x800f0020	inventory/chassis: Invalid slotid
0x800f0021	apps/netflow/records: Record invalid
0x800f0022	portConfig/portGroups: If portWeights is included, the list size must match the size of the 'ports' list.
0x800f0023	apps/ssl/keystore: Keystore password is already set

Error Code	Description
0x800f0024	apps/ssl/keystore: Keystore password is not set
0x800f0025	apps/ssl/keyMaps: Alias in the SslDecryptionKeyMapConfigSpec body must reference one of the existing GsGroups
0x800f0026	gsGroups: Invalid keymap
0x800f0027	general: 'time' must be in ISO-8601 date format 'yyyy-MM-dd'T'HH:mm:ssZ'
0x800f0028	maps: Invalid srcport
0x800f0029	maps: Invalid dstport
0x800f002a	maps: Incorrect ruleid
0x800f002b	maps: Only one of rules, gsRules, flowRules may be set.
0x800f002c	maps: Invalid ipv4
0x800f002d	maps: Invalid ipv6
0x800f002e	maps: Invalid cidrmask
0x800f002f	maps: Invalid mac
0x800f0030	maps: RuleMatching is only valid for regular/byRule map types
0x800f0031	maps: Asymmetric inlineTrafficType is only applicable for inline/passAll maps
0x800f0032	maps: InlineTrafficPath is only applicable for inline maps
0x800f0033	maps: TrafficType is only applicable to firstLevel map types
0x800f0034	maps/rules: Included rule elementes are mutually exclusive to each other
0x800f0035	maps/rules: 'valueMax' must be greater than 'value'
0x800f0036	maps/rules: Rule element is only allowed for gsRule.
0x800f0037	maps/rules: 'subset' is only valid when 'valueMax' is present.
0x800f0038	maps/rules: Value for pos is repeated
0x800f0039	gsops: TunnelDecap of type gmip requires value for gmipPort
0x800f003a	inline/networks: Invalid delete
0x800f003b	inline/serialToolGroups: Invalid inline tool
0x800f003c	inline/networkGroups: Invalid inline network
0x800f003d	gsops: FabricPath requires both fpSrcSwitchId and fpDstSwitchId
0x800f003e	gsops: Invalid gsapp

Error Code	Description
0x800f003f	gsops: Fm6000Ts requires timestampFormat
0x800f0040	system/aaa/auth: UnlockTime must be greater than or equal to lockTime
0x800f0041	apps/netflow/monitor: Invalid sampling space
0x800f0042	apps/saApfProfiles: Session field pos unhandled
0x800f0043	apps/saApfProfiles: Session field type unhandled
0x800f0044	apps/saApfProfiles: IPv4, and IPv6 field cannot be mixed in a session field
0x800f0045	inline/hbPackets: Size
0x800f0046	portConfig/portConfigs: Invalid ingress port vlan tag: 1
0x800f0047	portConfig/gigastreams: HC2 allows advanced-hash configuration for slot 'cc1' only. And it is shared across line-card modules.
0x800f0048	gsops: LbType 'gtpKeyHash' is only applicable when 'appType' is 'gtp'
0x800f0049	system/localUsers: Rsvd username
0x800f004a	apps/gtp/whitelists: System is busy processing GTP whitelist. Try again later.
0x800f004b	apps/gtp/whitelists: Exceed entry limit
0x800f004c	apps/gtp/whitelists: Exceed per file limit
0x800f004d	apps/gtp/whitelists: Cannot import file with invalid GTP whitelist entries or incorrect format
0x800f004e	apps/gtp/whitelists: Destroy in use
0x800f004f	apps/gtp/whitelists: The value for 'usage' must be one of 'create', 'delete'
0x800f0050	system/aaa/roles: A builtin role cannot be deleted or created.
0x800f0051	system/snmp: Invalid ipv4 ipv6
0x800f0052	apps/saApfProfiles: Invalid value for 'bufferSize': 1
0x800f0053	system/config: Directory not found
0x800f0054	system/snmp/notifTargets: V3User is required when version is 'v3'
0x800f0055	system/snmp: Only one communityString allowed when enableMultiCommunity is False
0x800f0056	gsops: Invalid offset
0x800f0057	gsops: Invalid combo
0x800f0058	gsops: FlowFilter, flowSample gtp, or gtpWhitelist must be configured for loadBalance stateful appType 'gtp'

Error Code	Description
0x800f0059	gsops: One and only one of stateful or stateless must be configured for loadBalance
0x800f005a	gsops: GsApp 'saApf' requires 'apf' to be enabled
0x800f005b	gsops: GsApp 'headerRemove' protocol 'isl' is not compatible with 'dedup' or 'tunnelDecap'
0x800f005c	system/license: Install error
0x800f005d	stats/port: Stat error
0x800f005e	apps/saApfProfiles: Redefine fail
0x800f005f	apps/netflow/exporters: Exporter in use
0x800f0060	inventory/chassis: Card mode fail
0x800f0061	gsGroups: Invalid watchdog timer
0x800f0062	general: Missing argument
0x800f0063	general: Unexpected exception
0x800f0064	general: Exception occurred in write_error(). Check the logs for more information.
0x800f0065	general: Method Not Allowed.
0x800f0066	general: Http error
0x800f0067	gsops: Erspan requires erspanFlowId
0x800f0068	/inline/negativeHbProfiles: Empty custom packet
0x800f0069	/inline/negativeHbProfiles: Invalid base64
0x800f006a	general: Admin account password must be changed via the CLI to a non-default value for security purposes.
0x800f006b	general: Bad filename
0x800f006c	Unknown error

Table 6: General Error Codes

Error Code	Description
0x80100000	No error
0x801036b0	Generic error
0x801036b1	Unexpected null

Error Code	Description
0x801036b2	Assertion failed
0x801036b3	Nyi
0x801036b4	Not found
0x801036b5	Exists
0x801036b6	Multiple
0x801036b7	Unexpected eof
0x801036b8	Unexpected arg
0x801036b9	Bad path
0x801036ba	Bad file
0x801036bb	No buffer space
0x801036bc	Parse error
0x801036bd	File not found
0x801036be	Io error
0x801036bf	Io blocking error
0x801036c0	Io closed
0x801036c1	Io timeout
0x801036c2	Io bad existence
0x801036c3	Io verify failed
0x801036c4	Io bad family
0x801036c5	Unexpected case
0x801036c6	Bad type
0x801036c7	Bad utf8 seq
0x801036c8	Divide by zero
0x801036c9	No fs space
0x801036ca	Decryption failure
0x801036cb	Read only
0x801036cc	Java exception
0x801036cd	Limit exceeded

Error Code	Description
0x801036ce	Too many fds
0x801036cf	Not initialized
0x801036d0	Lock busy
0x801036d1	Lock not locked
0x801036d2	Lock bad owner
0x801036d3	Range
0x801036d4	Invalid param
0x801036d5	Skip value
0x8010370a	Has children
0x8010370b	Not an ancestor
0x8010370c	No path
0x80103714	Foreach delete
0x80103715	Foreach remove
0x80103716	Foreach halt err
0x80103717	Foreach halt ok
0x8010371e	Reset timeout
0x8010371f	Event delete
0x80103723	Not cli shell
0x80103724	Cli cmd too long
0x80103728	Cancelled
0x80103729	Cancelled error
0x8010372d	Wrong num instances
0x80103779	Transient failure
0x801037dd	Db unrecognized type
0x801037de	Bw not available
0x801037df	Unknown error

GigaVUE-FM APIs

GigaVUE-FM APIs are designed with the Representational State Transfer (REST) architecture, which provides a well structured architecture for performing query, update, and delete functions in a programmatic manner. GigaVUE-FM APIs are implemented based on Open API 3.0 specification (formerly known as Swagger) and conform to required standards.

Topics:

- [Introduction and Concepts](#)
- [GigaVUE-FM API Workflows](#)
- [Working with GigaVUE-FM APIs](#)

GigaVUE-FM API Workflows

This chapter describes the basic workflow for a REST application and GigaVUE-FM using the APIs. The workflows described are:

- [REST Workflow](#)
- [GigaVUE-FM Workflow](#)

REST Workflow

Applications using the REST architecture follow a workflow that has two operations, which are as follows:

1. Make a request to the server to create, read, update, or delete a resource.
2. Handle the response to the request.

The response contains a status code, indicating whether the request succeeded or failed. The response can also contain data in a structured format, in addition to the status code. The application either takes further actions based on the status code or processes the data.

The application repeats the cycle of request and response as long as necessary, as shown in [Figure 2: REST Workflow](#).

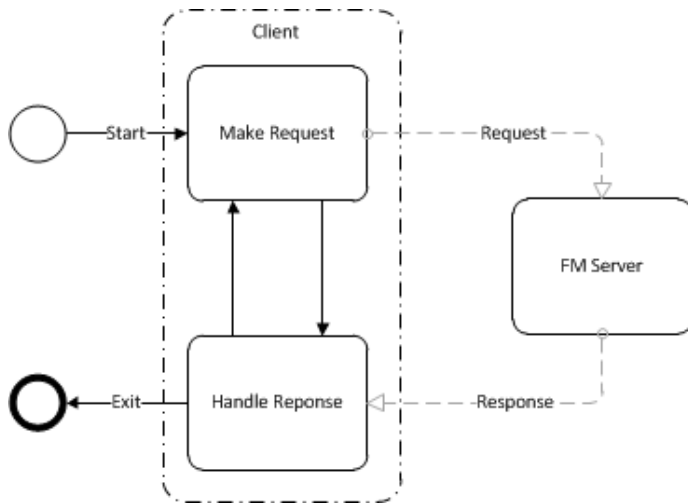


Figure 2: REST Workflow

GigaVUE-FM Workflow

This section describes how to use the GigaVUE-FM APIs in a general workflow. The topics covered are as follows:

- [Managing Physical Nodes](#)
- [Configuring Ports](#)
- [Configuring Traffic Maps](#)

Logging In and Logging Out

When using the GigaVUE-FM APIs, a script or application needs to first log in to GigaVUE-FM. This can be done creating a session for making a series of requests or logging prior to each individual request. In each case, the script or program *must end the session or log out when it is finished making a request or requests* to GigaVUE-FM. Failure to log out from GigaVUE-FM can result in an invalid credential error message being returned if the current request exceeds the maximum number of user sessions.

Managing Physical Nodes

The `/nodes` resource represents a physical node. Nodes can belong to a cluster. With the Gigamon node APIs, an application can perform the following operations on nodes:

- Add nodes to GigaVUE-FM and rediscover them. (Refer to [Adding Nodes](#).)
- Retrieve information about nodes from GigaVUE-FM. (Refer to [Getting Node Information](#).)
- Remove node clusters from GigaVUE-FM. (Refer to [Deleting Clusters or Nodes](#).)

Adding Nodes

An application can add nodes to GigaVUE-FM. The node is added through its node address. If the node is part of a cluster, it joins the cluster. If the node address is for a standalone node, that node is added to GigaVUE-FM.

The `/nodes` resource only provides information about the nodes. It does not provide any information about physical characteristics of the nodes. To get the physical characteristics, use a `GET` operation on the `/inventory/chassis` Or `/inventory/ports` resource or both.

To add a node, an application does the following:

1. Makes a **POST** request to the node resource.

POST `<fmip>/api/<api_version>/nodes`

The request needs to contain a payload that specifies a node address. For example, the following request body specifies that a node with address 10.115.152.54 is added:

```
{
  "nodeAddSpecs": [{
    "nodeAddress" : "10.115.152.54",
    "username" : "admin",
    "password" : "admin123A!"
  }]
}
```

If a failure occurs with adding the node, it is indicated in the response body. (For a description of the error message, refer to the *GigaVUE-FM API Reference*.)

2. Repeats step 1 as necessary to add additional nodes.
3. Rediscovered the nodes with the following **PUT** request:

PUT `<fmip>/api/<api_version>/nodes`

NOTE: This API does not include a content body in the request.

Getting Node Information

An application can use the GigaVUE-FM APIs to list the information about clusters and nodes. The APIs can return the information as a list of node clusters or as a flat list of nodes.

To retrieve a list of nodes clusters, an application uses the following request:

```
GET <fmip>/api/<api_version>/nodes
```

To retrieve a list of the nodes without grouping them by cluster, an application uses the following request:

```
GET <fmip>/api/<api_version>/nodes/flat
```


To retrieve information about a specific cluster, include the cluster ID in the request:

```
GET <fmip>/api/<api_version>/nodes?clusterId=<clusterId>
```

To retrieve information about a specific node, request a flat list of nodes and specify the node ID:

```
GET <fmip>/api/<api_version>/nodes/flat?nodeId=<nodeId>
```

Deleting Clusters or Nodes

To delete all clusters and standalone nodes, an application uses the following request:

```
DELETE <fmip>/api/<api_version>/nodes
```

To remove an entire cluster, an application uses the following request:

```
DELETE <fmip>/api/<api_version>/nodes?clusterId=<clusterId>
```

If **clusterId** identifies a standalone node, only the standalone node is deleted.

Configuring Ports

After an application adds nodes to GigaVUE-FM, the next step is to configure the ports. An application can use the APIs to create, show, update, and delete ports. In addition to adding port groups, an application can configure GigaStream. A GigaStream groups together multiple tool ports into logical bundles, allowing traffic to be distributed to multiple monitoring tools.

This following sections describes the tasks that an application can perform with the APIs on ports and GigaStream:

- [Getting Port Information](#)
- [Setting the Port Type and Enabling](#)
- [Creating Port Groups](#)
- [Getting Port Group Information](#)
- [Updating Port Groups](#)
- [Deleting a Port Group](#)
- [Creating GigaStream](#)
- [Getting GigaStream Information](#)
- [Deleting GigaStream](#)

Getting Port Information

To retrieve information about all ports, an application uses the following request:

```
GET <fmip>/api/<api_version>/inventory/ports?clusterId=<clusterId>
```

To retrieve information about a specific port, an application uses the following request:

```
GET <fmip>/api/<api_version>/inventory/ports/
    {portId}?clusterId=<clusterId>
```

The following is an example of the response returned from a request for information about a specific port, where the port ID is 5/2/x1:

```
{
  "port" : {
    "portId" : "5/2/x1",
    "alias" : "Spirent_P17",
    "comment" : "",
    "portType" : "network",
    "adminStatus" : "up",
    "operStatus" : "up",
    "licensed" : true,
    "medium" : "OPTICAL",
    "sfp" : {
      "sfpType" : "sfp+ sr",
      "sfpPower" : " -2.83 ",
      "vendorName" : "GIGAMON SFP-532",
      "vendorSn" : "MSP0GWZ      ",
      "vendorPn" : "GMON8571D3BCL-G"
    },
    "configSpeed" : "10G",
    "operSpeed" : "10G",
    "duplex" : "full",
    "autoNeg" : false,
    "forceLinkUp" : false,
    "mtu" : 9600,
    "healthState" : "green",
    "neighborDiscovery" : "none"
  }
}
```

Setting the Port Type and Enabling

To set the port type and enable it, an application uses the following request:

```
PATCH <fmip>/api/<api_version>/inventory/ports/{
portId}?clusterId=<clusterId>
```

The payload of the request specifies the port by its ID, the port type, and its administrative status. For example, the following payload makes port 5/2/x8 a network port with its administrative status enabled.

```
{
  "portId" : "5/2/x8",
  "portType" : "network",
  "adminStatus" : "up"
}
```

Creating Port Groups

To create a port group, an application makes the following request:

```
POST <fmip>/api/<api_version>/portConfig/    portGroups?clusterId=<clusterId>
```

This request needs to include a payload that describes the port group. For example, the following request body creates a port group with two ports:

```
{
  "alias" : "PG0",
  "ports" : [ "5/4/x4", "5/4/x1" ],
  "comment": " ",
}
```

The payload specifies that ports 5/4/x4 and 5/4/x1 are in the port group and the alias of the group is PG0.

Getting Port Group Information

To retrieve a list of the port groups, an application makes either of the following requests:

- **GET** <fmip>/api/<api_version>/portConfig/portGroups?clusterId=<clusterId>
- **GET** <fmip>/api/<api_version>/portConfig/portGroups/{alias}?clusterId=<clusterId>

Updating Port Groups

An application can update a port group through a **PUT** or a **PATCH** operation. The **PUT** operation replaces the current configuration of the port group. A **PATCH** operation modifies the port group. In general, a **PUT** operation is preferred over a **PATCH**.

To update or modify a port group, an application can use either of the following requests:

- **PUT** <fmip>/api/<api_version>/portConfig/portGroups/{alias}?clusterId=<clusterId>
- **PATCH** <fmip>/api/<api_version>/portConfig/portGroups/{alias}?clusterId=<clusterId>

This request needs to include a payload that describes the port group. For example, the following request body changes one port in the port group (5/4/x5 replaces 5/4/x1) and adds a third port to port group PG0:

```
{
  "alias" : "PG0",
  "ports" : [ "5/4/x4", "5/4/x5", "5/4/x6" ],
  "comment": " ",
}
```

NOTE: A **PUT** operation modifies the map with data provided in the request. A **PATCH** operation modifies individual properties of the map according to the instructions in the request. A **PUT** operation is preferred over a **PATCH** operation.

Deleting a Port Group

To delete a port group, an application uses the following request:

```
DELETE /portConfig/portGroups/{alias}?clusterId=<clusterId>
```

Creating GigaStream

To create a GigaStream, an application uses the following request:

```
POST <fmip>/api/<api_version>/portConfig/gigastreams?clusterId=<clusterId>
```

Getting GigaStream Information

An application can retrieve all GigaStream in a cluster or retrieve a specific GigaStream by its alias.

To retrieve all GigaStream, an application uses the following request:

```
GET <fmip>/api/<api_version>/portConfig/gigastreams?clusterId=<clusterId>
```

To retrieve a specific GigaStream, an application specifies the alias of the GigaStream in the request:

```
GET <fmip>/api/<api_version>/portConfig/gigastreams/{alias}?clusterId=<clusterId>
```

Deleting GigaStream

To delete GigaStream, an application uses the `DELETE` operation and specifies the alias of the GigaStream in the following request:

```
DELETE <fmip>/api/<api_version>/portConfig/gigastreams/{alias}?clusterId=<clusterId>
```

Configuring Traffic Maps

An application can use the GigaVUE-FM APIs to configure and modify traffic maps, which includes adding, defining, and deleting rules. Maps also use GigaSMART operations (gsop) that are assigned to a GigaSMART group (gsgroup).

Working with Maps

This section describes the following:

- [Creating Maps](#)
- [Getting Map Information](#)
- [Updating Maps](#)
- [Map Chains](#)

Creating Maps

To create a traffic map, an application uses the following request:

```
POST <fmip>/api/<api_version>/maps?clusterId=<clusterId>
```

The request contains a payload that describes the map. The following is an example of a payload that creates a map for passing IPv4 and IPv6 traffic:

```
{
  "alias" : "Map_RSA_Traffic",
  "type" : "regular",
  "subType" : "byRule",
  "srcPorts" : [ "5/2/x8" ],
  "dstPorts" : [ "5/2/x16" ],
  "order" : 1,
  "rules" : {
    "dropRules" : [ ],
    "passRules" : [ {
      "ruleId" : 1,
      "comment" : " ",
      "matches" : [ {
        "type" : "ipVer",
        "value" : "v4"
      } ]
    }, {
      "ruleId" : 2,
      "comment" : " ",
      "matches" : [ {
        "type" : "ipVer",
        "value" : "v6"
      } ]
    } ]
  },
  "ruleMatching" : "normal"
}
```

Getting Map Information

To retrieve a list of the maps, an application uses either of the following requests:

- GET <fmip>/api/<api_version>/maps?clusterId=<clusterId>
- GET <fmip>/api/<api_version>/maps/{alias}?clusterId=<clusterId>

The following is an example of the response returned from a request for information about a specific map, where the map alias is L1_Map_Mask:

```
{
  "map" : {
    "alias" : "L1_Map_Mask",
    "clusterId" : "10.115.152.50",
    "type" : "firstLevel",
    "subType" : "byRule",
    "srcPorts" : [ "5/2/x8" ],
    "dstPorts" : [ "vp5-1" ],
    "order" : 1,
    "rules" : {
      "passRules" : [ {
        "ruleId" : 1,
        "comment" : "",
        "bidi" : false,
        "matches" : [ {
```

```

        "type" : "macSrc",
        "value" : "0000.0000.0000",
        "mask" : "0000.0000.0000"
    } ]
} ]
},
"roles" : {
    "owners" : [ "admin" ],
    "viewers" : [ ],
    "editors" : [ ],
    "listeners" : [ ]
}
}
}

```

Updating Maps

To make changes to an existing map, an application uses the following request:

```
PUT <fmip>/api/<api_version>/maps/{alias}?clusterId=<clusterId>
```

The request contains a payload with the changes to the map.

The following example request and payload adds SSL decryption to the map shown in the previous section [Creating Maps](#), where the alias specified in the request is Map_RSA_Traffic:

```

payload = {
    "alias" : "Map_RSA_Traffic",
    "type" : "regular",
    "subType" : "byRule",
    "srcPorts" : [ "5/2/x8" ],
    "dstPorts" : [ "5/2/x16" ],
    "gsop" : "GSOP_SSL_RSA",
    "order" : 1,
    "rules" : {
        "dropRules" : [ ],
        "passRules" : [ {
            "ruleId" : 1,
            "comment" : "",
            "matches" : [ {
                "type" : "ipVer",
                "value" : "v4"
            } ]
        } ]
    } ]
},
"ruleMatching" : "normal"
}
PUT <fmip>/api/<api_version>/maps/Map_RSA_Traffic?clusterId=<clusterId>

```

An application can also use a `PATCH` operation to make changes to a map. However, `PUT` operations are preferred for making changes to a resource. For a description of these operations, refer to [HTTP Methods](#).

Map Chains

Map chains are traffic maps assigned to the same group of ports. All maps in a chain must share the same source ports, but they can have different destination ports. The maps in a map chain also have a priority. A chain can have a map without any rules that can be used as a shared collector.

Figure 3: Map Chain with Three Maps shows a map chain with three maps assigned to a port group. The maps use the same source ports and different destination ports. The red X indicates a connection to a source port not allowed in the chain because it is not shared by the other maps.

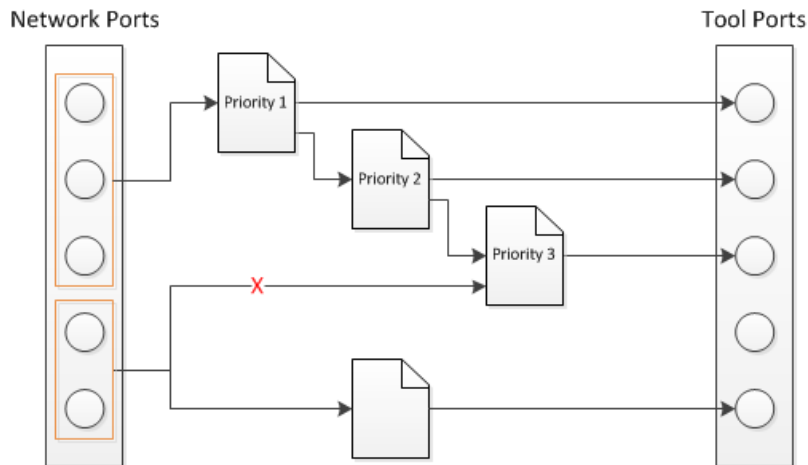


Figure 3: Map Chain with Three Maps

Map chains are identified by `mapChainId` attribute of a MapChain object and the priority of a map within a map chain is specified by the `order` attribute of the Map object. Prior to GigaVUE-FM 3.4, the ID of a map chain was specified by the `srcPortsAsId` attribute, which is deprecated.

Working with Rules

This section describes the following:

- [Adding Rules](#)
- [Modifying Rules](#)
- [Deleting Rules](#)

Adding Rules

To add a rule to a map, an application uses the following request:

```
POST <fmip>/api/<api_version>/maps/{alias}
     /rules/{pass|drop}?clusterId=<clusterId>
```

The request contains a payload with the rule to add to the specified map. The following payload example adds an IPv6 rule to a map:

```
{
```

```

    "ruleId" : 2,
    "comment" : "",
    "matches" : [ {
      "type" : "ipVer",
      "value" : "v6"
    } ]
  }
}

```

Modifying Rules

To modify a rule in a map, an application uses the following request:

```

PUT <fmip>/api/<api_version>/maps/{alias}/rules/{pass|drop}
/{ruleId}?clusterId=<clusterId>

```

The request contains a payload with the rule redefinition for the specified map. The following payload example changes the rule IP version to IPv4:

```

{
  "ruleId" : 2,
  "comment" : " ",
  "matches" : [ {
    "type" : "ipVer",
    "value" : "v4"
  } ]
}

```

Deleting Rules

An application can delete all the rules from a map or delete a specific rule.

To delete all rules from a map, an application uses the following request:

```

DELETE <fmip>/api/<api_version>/maps/{alias}/rules/?clusterId=<clusterId>

```

To delete a specific rule from a map, an application uses the following request:

```

DELETE <fmip>/api/<api_version>/maps/{alias}/rules
/{ruleId}?clusterId=<clusterId>

```

Working with GigaSMART Groups and Operations

Maps can include GigaSMART operations (gsop) and GigaSMART rules (gsrules). Before an application can add a gsop to a map, the gsop must be in a GigaSMART group (gsgroup). This means that an application may need to create a gsgroup before adding a gsop to a map.

This section describes the following:

- [Creating GigaSMART Groups](#)
- [Deleting a GigaSMART Group](#)
- [Adding a GigaSMART Operation to a GigaSMART Group](#)
- [Getting GigaSMART Operation Information](#)

- [Modifying a GigaSMART Operation](#)
- [Deleting a GigaSMART Operation](#)

Creating GigaSMART Groups

To create a GigaSMART group, an application uses the following request:

```
POST <fmip>/api/<api_version>/gsGroups?clusterId=<clusterId>
```

This request also needs to include a payload that describes the group. For example, the following payload creates a GigaSMART group with the alias GS1 and associates it with engine port 10/1/e1:

```
{
  "alias" : "GS1",
  "ports" : [ "10/1/e1" ],
}
```

Deleting a GigaSMART Group

To delete a GigaSMART group, an application uses the following request:

```
DELETE <fmip>/api/<api_version>/gsGroups/{alias}?clusterId=<clusterId>
```

Adding a GigaSMART Operation to a GigaSMART Group

To add a gsop to a GigaSMART group, an application makes the following request:

```
POST <fmip>/api/<api_version>/gsops?clusterId=<clusterId>
```

This request also needs to include a payload that specifies the gsop to add to the gsGroup. For example, the following payload is for a masking operation that is added to the gsGroup with the alias GS1:

```
payload = {
  "alias" : 'masking',
  "gsGroup" : "GS1",
  "gsApps" : {
    "masking" : {
      "protocol" : "none",
      "offset" : 64,
      "pattern" : 'b',
      "length" : 13
    }
  }
}
```

Getting GigaSMART Operation Information

An application can retrieve all gsop in a cluster or retrieve a specific gsop by its alias.

To retrieve all gsop, an application uses the following request:

```
GET <fmip>/api/<api_version>/gsops?clusterId=<clusterId>
```

To retrieve a specific gsop, an application specifies the alias of the gsop in the request:

```
GET <fmip>/api/<api_version>/gsops/gigastreams/{alias}?clusterId=<clusterId>
```

Modifying a GigaSMART Operation

To modify an existing gsop, an application uses the following request:

```
PATCH <fmip>/api/<api_version>/gsops/{alias}/apps?clusterId=<clusterId>
```

For example, to modify the GigaSMART operation added in the previous section, the payload and request are as follows:

```
payload = {
  "masking" : {
    "protocol" : "tcp",
    "offset" : 4,
    "pattern" : 'b',
    "length" : 13
  }
}
PATCH <fmip>/api/<api_version>/gsops/masking/apps?clusterId=<clusterId>
```

Deleting a GigaSMART Operation

To delete a a gsop, an application uses the following request:

```
DELETE <fmip>/api/<api_version>/gsops/{alias}?clusterId=<clusterId>
```

Working with GigaVUE-FM APIs

The GigaVUE-FM APIs can be used as part of IT Operations Management (ITOM) or implemented in a tool to perform a number of tasks. This chapter describes some ITOM use cases. The use cases described are as follows:

- [Working with Nodes](#)
- [Working with Ports](#)
- [Creating, Modifying, and Deleting Maps](#)

Working with Nodes

An application can use the GigaVUE-FM APIs to get nodes, ports, and their status in the Visibility Fabric.

This section describes the following:

- [Adding Nodes](#)
- [Getting Node Information](#)
- [Getting Chassis Information](#)

Adding Nodes

To add nodes, an application does the following:

1. Makes the following request to add nodes or clusters:

```
POST <fmip>/api/<api_version>/nodes
```

2. Rediscovered the nodes and clusters with the following request:

```
PUT <fmip>/api/<api_version>/nodes
```

The following is a code example that creates three nodes and then rediscovered the nodes managed by GigaVUE-FM after each node is added:

```
nodeAddresses = ["10.115.152.50", "10.115.152.51",
                 "10.115.152.54"]
for address in nodeAddresses:
    payload = {
        "nodeAddSpecs": [{
            "nodeAddress": address,
            "username": "",
            "password": ""
        }]
    }
    POST https://10.115.152.46/api/<api_version>/nodes
    Authorization: Basic 'dXNlcm5hbWU6cGFzc3dvcmQ='
    Content-Type : application/json
    Accept : application/json
    Content-Length : 82
    #On success, make a PUT request to rediscover nodes
    if status = 200:
        PUT https://10.115.152.46/api/<api_version>/nodes
        Authorization: Basic 'dXNlcm5hbWU6cGFzc3dvcmQ='
        Accept : application/json
    else:
        print response.content #If not successful, display response.
        exit()
```

Getting Node Information

The following example requests the information for all nodes as a flat list:

```
GET https://10.115.142.46/api/<api_version>/nodes/flat
Authorization: Basic 'dXNlcm5hbWU6cGFzc3dvcmQ='
Accept: application/json
```

On success, the response returns the following data in JSON format, showing that there are six nodes. Three nodes are standalone nodes and three nodes belong to a cluster.

```
{
  "nodes" : [ {
    "deviceId" : "10.115.152.50",
    "deviceIp" : "10.115.152.50",
    "dnsName" : "hc2-c04-29.gigamon.com",
    "hostname" : "HC2-C04-29",
    ...
  }
]
```

```

        "clusterMode" : "Standalone",
        "clusterId" : "10.115.152.50",
        ...
    }, {
        "deviceId" : "10.115.152.51",
        "deviceIp" : "10.115.152.51",
        "dnsName" : "ta1-c04-35.gigamon.com",
        "hostname" : "TA1-C04-35",
        ...
        "clusterMode" : "Standalone",
        "clusterId" : "10.115.152.51",
        ...
    }, {
        "deviceId" : "10.115.152.54",
        "deviceIp" : "10.115.152.54",
        "hostname" : "HB1-C03-21",
        ...
        "clusterMode" : "Standalone",
        "clusterId" : "10.115.152.54",
        ...
    }, {
        "deviceId" : "10.115.152.55",
        "deviceIp" : "10.115.152.55",
        "hostname" : "HB1-C03-22",
        ...
        "clusterMode" : "Standalone",
        "clusterId" : "10.115.152.55",
        ...
    }, {
        "deviceId" : "10.115.155.3",
        "deviceIp" : "10.115.155.3",
        "hostname" : "HB1-Team1",
        "family" : "H",
        ...
        "clusterMode" : "Slave",
        "clusterMaster" : "10.115.155.4",
        "clusterId" : "GCC-1",
        ...
    }, {
        "deviceId" : "10.115.155.4",
        "deviceIp" : "10.115.155.4",
        "hostname" : "HC2-Team1",
        ...
        "clusterMode" : "Master",
        "clusterMaster" : "10.115.155.4",
        "clusterId" : "GCC-1",
        ...
    }, {
        "deviceId" : "10.115.155.5",
        "deviceIp" : "10.115.155.5",
        "hostname" : "HD8-Team1",
        ...
        "clusterMode" : "Standby",
        "clusterMaster" : "10.115.155.4",
        "clusterId" : "GCC-1",
        ...
    } ]
}

```

The following example requests the information for all nodes:

```
GET https://10.115.142.46/api/<api_version>/nodes
Authorization: Basic 'dXNlcm5hbWU6cGFzc3dvcmQ='
Accept: application/json
```

On success, the response returns the following data in JSON format, showing the nodes grouped by cluster IDs. The response shows three standalone nodes and a node cluster named GCC-1 with three nodes.

```
{
  "clusters" : [ {
    "family" : "H",
    "clusterId" : "10.115.152.50",
    "members" : [ {
      "deviceId" : "10.115.152.50",
      "deviceIp" : "10.115.152.50",
      "dnsName" : "hc2-c04-29.gigamon.com",
      "hostname" : "HC2-C04-29",
      ...
      "clusterMode" : "Standalone",
      "clusterId" : "10.115.152.50",
      ...
    } ]
  }, {
    "family" : "H",
    "clusterId" : "10.115.152.51",
    "members" : [ {
      "deviceId" : "10.115.152.51",
      "deviceIp" : "10.115.152.51",
      "dnsName" : "ta1-c04-35.gigamon.com",
      "hostname" : "TA1-C04-35",
      ...
      "clusterMode" : "Standalone",
      "clusterId" : "10.115.152.51",
      ...
    } ]
  }, {
    "family" : "H",
    "clusterId" : "10.115.152.54",
    "members" : [ {
      "deviceId" : "10.115.152.54",
      "deviceIp" : "10.115.152.54",
      "hostname" : "HB1-C03-21",
      ...
      "clusterMode" : "Standalone",
      "clusterId" : "10.115.152.54",
      ...
    } ]
  }, {
    "family" : "H",
    "clusterId" : "10.115.152.55",
    "members" : [ {
      "deviceId" : "10.115.152.55",
      "deviceIp" : "10.115.152.55",
      "hostname" : "HB1-C03-22",
      ...
    } ]
  } ]
}
```

```

        "clusterMode" : "Standalone",
        "clusterId" : "10.115.152.55",
        ...
    } ]
}, {
    "family" : "H",
    "clusterId" : "GCC-1",
    "clusterVip" : "10.115.155.2",
    "masterId" : "10.115.155.4",
    "members" : [ {
        "deviceId" : "10.115.155.3",
        "deviceIp" : "10.115.155.3",
        "hostname" : "HB1-Team1",
        ...
        "clusterMode" : "Slave",
        "clusterMaster" : "10.115.155.4",
        "clusterId" : "GCC-1",
        ...
    }, {
        "deviceId" : "10.115.155.4",
        "deviceIp" : "10.115.155.4",
        "hostname" : "HC2-Team1",
        ...
        "clusterMode" : "Master",
        "clusterMaster" : "10.115.155.4",
        "clusterId" : "GCC-1",
        ...
    }, {
        "deviceId" : "10.115.155.5",
        "deviceIp" : "10.115.155.5",
        "hostname" : "HD8-Team1",
        ...
        "clusterMode" : "Standby",
        "clusterMaster" : "10.115.155.4",
        "clusterId" : "GCC-1",
        ...
    } ]
} ]
}

```

Getting Chassis Information

Queries to the /node resource provides only general information about a node or cluster. To get more detailed information, an application can make queries to the resource/inventory/chassis.

The following example queries the /inventory/chassis resource, and then retrieves card information from the response:

```

GET https://10.115.152.46/api/<api_
version>/inventory/chassis?clusterId=10.115.152.50
Authorization: Basic 'dXNlcm5hbWU6cGFzc3dvcmQ='
Accept : application/json
#On success, display the card information.
if status_code == 200:
    chassisInfo = json.loads(response.text)#Deserialize JSON
    chassisList = chassisInfo['chassisList']
    cards = chassisList[0]['cards']

```

```

for card in cards:
    print 'Slot ID: ' + card['slotId']
    print 'HW Type: ' + card['hwType']
    print 'Operational State: ' + card['operStatus']
    print 'State: ' + card['healthState']

```

Example: Checking for a GigaSMART Card

To use a GigaSMART operation (gsop), a GigaSMART card must be installed. An application can check for a card before adding the operation.

To check for a card and then add a gsop, an application performs the following steps:

1. Makes an inventory of the chassis by sending the following request:

```

GET https://10.115.152.46/api/<api_version>/inventory/
    chassis?clusterId=clusterId=10.115.152.50

```

The response contains a list of the cards.

2. On success of the request (that is, the request returns status code 200), the application looks for the GigaSMART card in the card list.

The following code example looks for the card in the JSON data returned in the response and prints information about the card:

```

chassisInfo = json.loads(r.text) #Deserialize JSON
chassisList = chassisInfo['chassisList']
cards = chassisList[0]['cards']
for card in cards:
    if card['hwType'] == 'HC2-GigaSMART':
        installed = True
        print 'Slot ID: ' + card['slotId']
        print 'HW Type: ' + card['hwType']
        print 'Amin Status' + card['adminStatus']
        print 'Operational Status: ' + card['operStatus']
        print 'Health: ' + card['healthState']

```

3. If the card exists, the application adds the gsop to a gsgroup with the following request:

```

if installed:
    POST https://10.115.152.46/api/<api_version>
        /gsops?clusterId=clusterId=10.115.152.50

```

The following is an example of the payload included in the request to add a gsop for SSL decryption.

```

{
    "alias" : "GSOP_SSL_RSA",
    "gsGroup" : "GS5",
    "gsApps" : {
        "sslDecrypt" : {
            "inPort" : 0,
            "outPort" : 0
        }
    },
    "clusterName" : "10.115.152.50"
}

```

Working with Ports

In addition to using the GigaVUE-FM APIs to configure ports as described in [GigaVUE-FM API Workflows](#) an application can also use the `/inventory/ports` resource to retrieve port information and change port types.

Getting Port Information

An application can use the GigaVUE-FM APIs to get information about ports. The following example inventories the ports and displays the ports with an administrative status of *down*:

```
GET https://10.115.152.46/api/<api_
version>/inventory/ports?nodeId=10.115.152.50
Authorization: Basic 'dXNlcm5hbWU6cGFzc3dvcmQ='
Content-Type : application/json
#On success, display the port information.
if code_status == 200:
    portInventory = json.loads(r.text) #Deserialize JSON.
    ports = portInventory["ports"]
    status = 'down'
    print 'Administrative status ' + status
    for port in ports:
        adminStatus = port['adminStatus']
        operStatus = port ['operStatus']
        if adminStatus == status:
            print 'Port %s' % port['portId']
            print '  Admin Status: %s' % port['adminStatus']
            print '  Op Status: %s' % port['operStatus']
            print '  Health: %s' % port['healthState']
```

Changing the Port Type and Enabling

An application can use the `/inventory/port` resource to change a port to a different type and change its status, such as change a port to a network port and enable its administrative status.

The following example changes port 5/2/x8 to a network port and port 5/2/x16 to a tool port by using a PATCH operation with `/inventory/ports/{portId}`.

NOTE: When specifying a port ID in a request, replace the forward slash character "/" with the underline character "_". For example, 5/2/x8 becomes 5_2_x8.

```
#List of ports with port type
portList = {'5/2/x8':'network', '5/2/x16':'tool'}
payload = {'portId' : 'id', 'portType" : 'type', 'adminStatus' : 'up'}
#Loop through list of ports
for portId, type in portList.iteritems():
    #Put port ID and port type into payload
    payload["portId"] = portId
    payload["portType"] = type

#Get content length for request
length = len(json.dumps(payload))
```



```

pid = portId.replace('/', '_'] #Change characters in ID.
                                #For example, 5/2/x8 becomes 5_2_x8.
PATCH https://10.115.152.46/api/<api_version>/inventory/ports/
      pid?clusterId=10.115.152.50
Authorization: Basic 'dXNlcm5hbWU6cGFzc3dvcmQ='
Content-Type : application/json
Accept : application/json
Content-Length : length
#Display changes to port if PATCH request succeeds
if status_code = 200:

    GET https://10.115.152.46/api/<api_version>/inventory/ports/
      pid?clusterId=10.115.152.50
Authorization: Basic 'dXNlcm5hbWU6cGFzc3dvcmQ='
Accept : application/json

portInventory = json.loads(r.text)#Deserialize JSON
port = portInventory["port"]
print 'Port %s' % port['portId']
print '  Port Type: %s' % port['portType']
print '  Admin Status: %s' % port['adminStatus']
print '  Op Status: %s' % port['operStatus']
else:
    #Handle error if return status is not 200
    gigaErrors = json.loads(resp.text)#Deserialize JSON
    errors = gigaErrors['errors']
    for err in errors:
        print 'GigaError ' + err['code']
        print err['msg']
        exit()

```

Creating, Modifying, and Deleting Maps

This section provides information about how an application can use the GigaVUE-FM APIs to work with maps. This section covers the following topics:

- [Creating Maps](#)
- [Modifying Maps](#)
- [Deleting Maps](#)

Creating Maps

The following section shows some examples of creating maps with the GigaVUE-FM APIs. The examples are as follows:

- [Creating a Map By Rule](#)
 - In this example, a map by rule is created, which is later used in the section [Modifying Maps](#).
- [Creating Maps for Dropping Traffic on a Session](#)
 - In this example, a first-level, a second-level, and a collector map are created.
- [Creating Maps for Masking Data](#)

In this example, first- and second-level maps are created.

Creating a Map By Rule

The following example creates a map by rule that passes IPv4 and IPv6 traffic between the source network port 5/2/x8 and the destination tool port 5/2/x16. An application can set the port types of these ports and their administrative status as described in [Changing the Port Type and Enabling](#) before creating the map.

```
payload = {
  'alias': 'Map_RSA_Traffic',
  'rules': {
    'dropRules': [],
    'passRules': [{
      'comment': '',
      'matches': [{
        'type': 'ipVer',
        'value': 'v4'
      }],
      'ruleId': 1
    }, {
      'comment': '',
      'matches': [{
        'type': 'ipVer',
        'value': 'v6'
      }],
      'ruleId': 2
    }],
    'subType': 'byRule',
    'clusterName': '10.115.152.50',
    'srcPorts': ['5/2/x8'],
    'ruleMatching': 'normal',
    'type': 'regular',
    'order': 1,
    'dstPorts': [ '5/2/x16' ]
  }
}
POST https://10.115.152.46/api/<api_version>/maps?clusterId=10.115.152.50
Authorization: Basic 'dXNlcm5hbWU6cGFzc3dvcmQ='
Content-Type : application/json
Accept : application/json
Content-Length : 384
```

Creating Maps for Dropping Traffic on a Session

This section shows an example of how to use the /map APIs to create maps that drop traffic for a session. In this use case, an application does the following:

1. Creates a first-level map that passes any MAC address and connects the map to a network port and a virtual port.
2. Creates a second level map that implements a Session-aware Adaptive Packet Filtering (SAPF) gsop and connects this map to the virtual port in the previous step and a tool port.
3. Creates a collector map connected to the same virtual port and tool port as the second level map.

Figure 4: Maps for Dropping Traffic shows the maps and their relation to the ports resulting from the previous three steps.

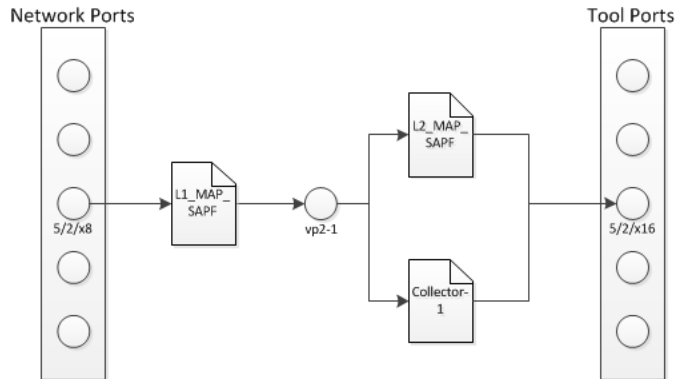


Figure 4: Maps for Dropping Traffic

Creating the First-level Map

The following example creates a first-level map that passes any MAC address. The source port (srcPorts) is 5/2/x8. The destination port (dstPorts) is a virtual port, vp2-1.

```

payload = {
  "alias": "L1_Map_SAPF",
  "rules": {
    "passRules": [{
      "comment": " ",
      "ruleId": 1,
      "matches": [{
        "type": "macSrc",
        "mask": "0000.0000.0000",
        "value": "0000.0000.0000"
      }]
    }]
  },
  "dstPorts": [ "vp2-1" ],
  "subType": "byRule",
  "srcPorts": [ "5/2/x8" ],
  "type": "firstLevel",
  "order": 1
}

```

```

POST https://10.115.152.46/api/<api_version>/maps?clusterId=10.115.152.50
Authorization: Basic 'dXNlcm5hbWU6cGFzc3dvcmQ='
Content-Type : application/json
Accept : application/json
Content-Length : 263

```

Creating the Second-level Map

The following example shows how to create a second-level map with a SAPF gsop. The source port (srcPorts) is vp2-1. The destination port (dstPorts) is 5/2/x16.

```

payload = {
  "alias": "L2_Map_SAPF",
  "srcPorts": [ "vp2-1" ],

```

```

    "subType": "byRule",
    "dstPorts": [ "5/2/x16" ],
    "type": "secondLevel",
    "gsop": "GSOP_GS2_APF",
    "gsRules": {
      "dropRules": [{
        "matches": [{
          "matchOffset": {
            "offsetStart": 1,
            "offsetEnd": 1750,
            "protocol": {
              "protocol": "tcp",
              "pos": 1
            }
          },
          "value": "netflix|nflxvideo|nflximg|Netflix|nflxext",
          "matchType": "regex",
          "type": "pmatch"
        }],
        "ruleId": 1
      }]
    }
  }
}
POST https://10.115.152.46/api/<api_version>/maps?clusterId=10.115.152.50
Authorization: Basic 'dXNlcm5hbWU6cGFzc3dvcmQ='
Content-Type : application/json
Accept : application/json
Content-Length : 376

```

Creating the Collector Map

The following example creates a shared collector map. The source port (srcPorts) is vp2-1. The destination port (dstPorts) is a virtual port, 5/2/x16.

```

payload = {
  "alias": "Collector-1",
  "dstPorts": [ "5/2/x16" ],
  "subType": "collector",
  "srcPorts": [ "vp2-1" ],
  "type": "secondLevel"
}
POST https://10.115.152.46/api/<api_version>/maps?clusterId=10.115.152.50
Authorization: Basic 'dXNlcm5hbWU6cGFzc3dvcmQ='
Content-Type : application/json
Accept : application/json
Content-Length : 119

```

Creating Maps for Masking Data

Often certain fields must be masked with a pattern to protect sensitive information during network analysis. In this use case, an application creates maps that mask the data when the data matches a certain pattern. To create the maps and mask the data, an application performs the following steps:

1. Creates a first-level map that is connected a network port and a virtual port. This map passes any MAC address.

2. Creates a second-level map that is connected to the virtual port in step 1 and a tool port. This second-level map implements a masking gsop.

Creating the First-level Map

The following example creates a first-level map that passes any MAC address. The source port (srcPorts) is 5/2/x8. The destination port (dstPorts) is a virtual port, vp5-1.

```
payload = {
  "alias": "L1_Map_Mask",
  "rules": {
    "passRules": [{
      "comment": "",
      "ruleId": 1,
      "matches": [{
        "type": "macSrc",
        "mask": "0000.0000.0000",
        "value": "0000.0000.0000"
      }]
    }]
  },
  "dstPorts": [ "vp5-1" ],
  "subType": "byRule",
  "srcPorts": [ "5/2/x8" ],
  "type": "firstLevel",
  "order": 1
}
```

```
POST https://10.115.152.46/api/<api_version>/maps?clusterId=10.115.152.50
Authorization: Basic 'dXNlcm5hbWU6cGFzc3dvcmQ='
Content-Type : application/json
Accept : application/json
Content-Length : 264
```

Creating the Second-level Map

The following example creates a second-level map with an APF gsop and masking, where 0 replaces the numbers in an identification number. The source port (srcPorts) is vp2-5. The destination port (dstPorts) is 5/2/x16.

```
payload = {
  "alias": "L2_Map_Mask",
  "srcPorts": [ "vp5-1" ],
  "subType": "byRule",
  "dstPorts": [ "5/2/x16" ],
  "type": "secondLevel",
  "gsop": "GSOP_GS5_APF_Mask",
  "gsRules": {
    "passRules": [{
      "matches": [{
        "matchOffset": {
          "offsetStart": 1,
          "offsetEnd": 1750,
          "protocol": {
            "pos": 1,
            "protocol": "tcp"
          }
        }
      }]
    }]
  }
}
```

```

    },
    "mask": {
      "pattern": "0",
    },
    "value": "\\d{3}-?\\d{7}-?\\d{7}",
    "matchType": "regex",
    "type": "pmatch"
  }],
  "ruleId": 2
}
}
}
}
}

POST https://10.115.152.46/api/<api_version>/maps?clusterId=10.115.152.50
Authorization : Basic 'YWRtaW4gYWRtaW4xMjNBIO=='
Content-Type : application/json
Accept : application/json
Content-Length : 389

```

Modifying Maps

An application can use the GigaVUE-FM APIs to modify a map when a tool detects an event in the traffic flow. In the use case described in this section, traffic is flowing between two hosts after a flow map was created. The tool detects SSL traffic with clear text. However, the tool that is monitoring the traffic needs the flow decrypted. It indicates to the application that it needs to add an SSL decryption GSOP to the existing map. [Figure 5: GigaVUE-FM API Application Modifying a Map](#) illustrates the process.

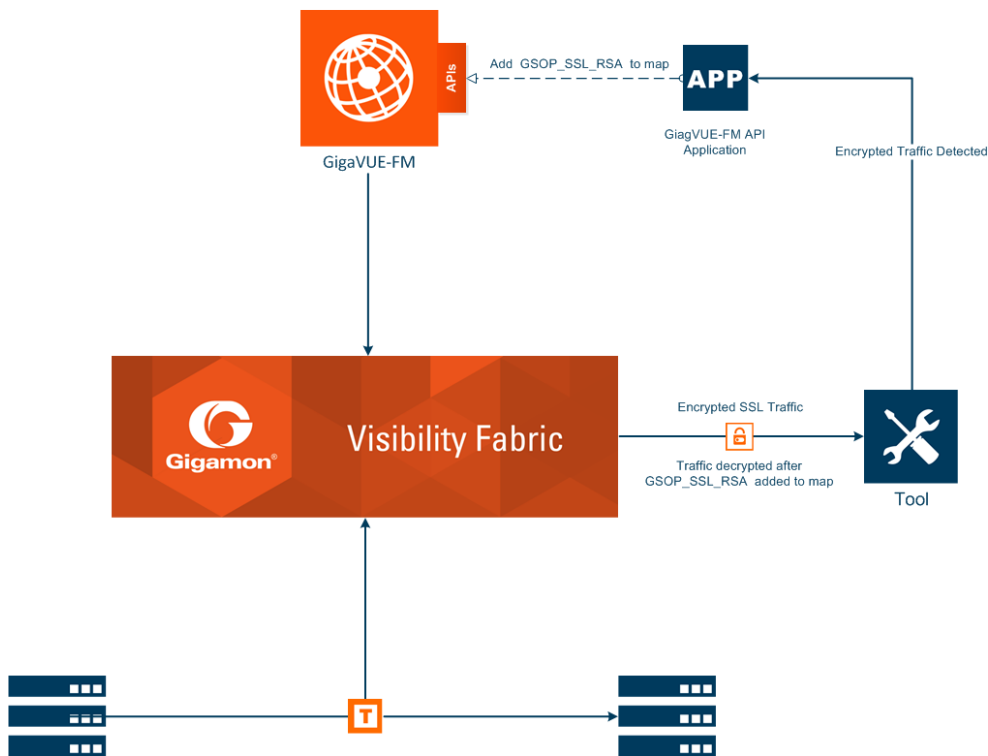


Figure 5: GigaVUE-FM API Application Modifying a Map

To modify the map, the application uses a PUT operation to modify the map, specifying the map by its alias. In this example, the map `Map_RSA_Traffic` previously described in [Creating a Map By Rule](#) is modified.

The following is an example of a request and payload that the application can send to GigaVUE-FM to modify the map with the alias `Map_RSA_Traffic`. The request adds the SSL RSA gsop, changes the order to 2 from 1, and the IP from IPv6 to IPv4.

```
payload = {
  "alias" : "Map_RSA_Traffic",
  "clusterName" : "10.115.152.50",
  "type" : "regular",
  "subType" : "byRule",
  "srcPorts" : [ "5/2/x8" ],
  "dstPorts" : [ "5/2/x16" ],
  "gsop" : "GSOP_SSL_RSA",
  "order" : 2,
  "rules" : {
    "dropRules" : [ ],
    "passRules" : [ {
      "ruleId" : 1,
      "comment" : "",
      "matches" : [ {
        "type" : "ipVer",
        "value" : "v4"
      } ]
    } ]
  } ]
},
"ruleMatching" : "normal"
}
PUT https://10.115.152.46/api/<api_version>/maps/ Map_RSA_Traffic?clusterId=10.115.152.50
Authorization: Basic 'dXNlcm5hbWU6cGFzc3dvcmQ='
Content-Type : application/json
Accept : application/json
Content-Length : 340
```

By making a GET request to the `/map` resource, the application shows that the map now includes the SSL RSA gsop and the other changes.

```
Get https://10.115.152.46/api/<api_version>/maps/ Map_RSA_Traffic?clusterId=10.115.152.50
Authorization: Basic 'dXNlcm5hbWU6cGFzc3dvcmQ='
Accept : application/json
```

The following is the content in the response:

```
{
  "map" : {
    "alias" : "Map_RSA_Traffic",
    "clusterId" : "10.115.152.50",
    "type" : "regular",
    "subType" : "byRule",
```

```

    "srcPorts" : [ "5/2/x8" ],
    "dstPorts" : [ "5/2/x16" ],
    "gsop" : "GSOP_SSL_RSA",
    "order" : 2,
    "rules" : {
      "dropRules" : [ ],
      "passRules" : [ {
        "ruleId" : 1,
        "comment" : "",
        "bidi" : false,
        "matches" : [ {
          "type" : "ipVer",
          "value" : "v4"
        } ]
      } ]
    } ]
  },
  "roles" : {
    "owners" : [ "admin" ],
    "viewers" : [ ],
    "editors" : [ ],
    "listeners" : [ ]
  },
  "ruleMatching" : "normal"
}
}

```

Deleting Maps

To delete maps, an application uses the DELETE operation on the /maps resource. The following example deletes three maps by their alias:

```

mapList = ["L1_Map_SAPF", "L1_Map_SAPF", "Collector-1"]
for mapAlias in mapList:
  DELETE https://10.115.152.46/api/<api_version>/maps/mapAlias
    ?clusterId=10.115.152.50
  Authorization: Basic 'dXNlcm5hbWU6cGFzc3dvcmQ='
  Accept : application/json
  #Display status code and message if request does not delete map.
  if code_status != 200:
    print 'Request failed...'
    gigaErrors = json.loads(resp.text)
    errors = gigaErrors['errors']
    for err in errors:
      print 'GigaError ' + err['code']
      print err['msg'] + '\n'
    exit()

```

GigaVUE-FM API Reference

The the GigaVUE-FM API Reference is available as part of the GigaVUE-FM Online Help. To view the reference, select **API Reference** in the Navigation pane under Support.

Additional Sources of Information

This appendix provides additional sources of information. Refer to the following sections for details:

- [Documentation](#)
- [Documentation Feedback](#)
- [Contact Technical Support](#)
- [Contact Sales](#)
- [The Gigamon Community](#)

Documentation

The following table provides a list of the additional documentation provided for GigaVUE H Series and TA Series nodes. "*" indicates new documents in this release. "***" indicates documents that are renamed in this release.



NOTE: Release Notes are not included in the online documentation. Registered Customers can download the Release Notes from the Software & Docs page on to [My Gigamon](#). Refer to [How to Download PDFs from My Gigamon](#).



TIP: If you keep all PDFs for a particular release in common folder, you can easily search across the doc set by opening one of the files in Acrobat and choosing **Edit > Advanced Search** from the menu. This opens an interface that allows you to select a directory and search across all PDFs in a folder.

Table 1: Documentation Suite for Gigamon Products

Summary	Document
Hardware Installation Guides	
<ul style="list-style-type: none"> • how to unpack, assemble, rack-mount, connect, and initially configure the respective GigaVUE devices • reference information and specifications for the respective GigaVUE devices 	GigaVUE-HC1 Hardware Installation Guide
	GigaVUE-HC2 Hardware Installation Guide
	GigaVUE-HC3 Hardware Installation Guide
	GigaVUE TA Series Hardware Installation Guide
Software Installation and Upgrade Guides	
<ul style="list-style-type: none"> • how to install GigaVUE-FM on VMware ESXi, MS Hyper-V, and KVM • how to migrate GigaVUE-FM on VMware ESXi, Hardware Appliance, and AWS 	**GigaVUE-FM Installation and Migration Guide
<ul style="list-style-type: none"> • how to upgrade the embedded GigaVUE-OS on GigaVUE H Series and GigaVUE TA Series nodes 	GigaVUE-OS Upgrade Guide
Administration Guide	
<ul style="list-style-type: none"> • how to administer the GigaVUE-OS and GigaVUE-FM software 	GigaVUE-OS and GigaVUE-FM Administration Guide
Configuration and Monitoring Guides	
<ul style="list-style-type: none"> • how to install, deploy, and operate GigaVUE • how to configure GigaSMART operations 	GigaVUE-FM User's Guide
<ul style="list-style-type: none"> • how to deploy the GigaVUE Cloud Suite solution in any cloud platform 	GigaVUE Cloud Suite for AnyCloud Configuration Guide

Summary	Document
<ul style="list-style-type: none"> how to configure the GigaVUE Cloud Suite components and set up traffic monitoring sessions for the respective cloud platform 	GigaVUE Cloud Suite for AWS Configuration Guide
	GigaVUE Cloud Suite for AWS QuickStart Guide
	*GigaVUE Cloud Suite for AWS SecretRegions Configuration Guide
	GigaVUE Cloud Suite for Azure Configuration Guide
	GigaVUE Cloud Suite for Kubernetes Configuration Guide
	*GigaVUE Cloud Suite for Nutanix Configuration Guide
	GigaVUE Cloud Suite for OpenStack Configuration Guide GigaVUE Cloud Suite for VMware Configuration Guide
Reference Guides	
<ul style="list-style-type: none"> library of GigaVUE-OS CLI (Command Line Interface) commands used to configure and operate GigaVUE H Series and TA Series devices 	GigaVUE-OS-CLI Reference Guide
<ul style="list-style-type: none"> guidelines for the different types of cables used to connect Gigamon devices 	GigaVUE-OS Cabling Quick Reference Guide
<ul style="list-style-type: none"> compatibility information and interoperability requirements for Gigamon devices 	GigaVUE-OS Compatibility and Interoperability Matrix
<ul style="list-style-type: none"> samples uses of the GigaVUE-FM Application Program Interfaces (APIs) <div data-bbox="180 1186 797 1270" style="border: 1px solid black; padding: 5px;"> <p>NOTE: Content will be merged into the GigaVUE-FM User's Guide in a future release.</p> </div>	GigaVUE-FM REST API Reference in GigaVUE-FM User's Guide
Release Notes	
<ul style="list-style-type: none"> new features, resolved issues, and known issues in this release important notes regarding installing and upgrading to this release <div data-bbox="180 1522 797 1638" style="border: 1px solid black; padding: 5px;"> <p>NOTE: In 5.7.00, the Release Notes documents combines GigaVUE-OS, GigaVUE-FM, and GigaVUE Cloud Suite into one document.</p> </div>	GigaVUE-OS, GigaVUE-FM, GigaVUE-VM, and GigaVUE Cloud Suite Release Notes

Summary	Document
In-Product Help	
<ul style="list-style-type: none"> how to install, deploy, and operate GigaVUE. Provided from the GigaVUE interface. 	GigaVUE-FM Online Help
<ul style="list-style-type: none"> the web-based GUI for the GigaVUE-OS. Provided from the GigaVUE-OS H-VUE interface. 	GigaVUE-OS H-VUE Online Help

NOTE: Registered customers can log in to [My Gigamon](#) to download documentation for specific releases under Software & Documentation Downloads. Refer to [How to Download PDFs from My Gigamon](#).

How to Download PDFs from My Gigamon

To download release-specific PDFs:

1. Log in to [My Gigamon](#)
2. Click on the **Software & Documentation** link.
3. Use the **Product** and **Release** filters to find documentation for the current release. For example, select Product: "GigaVUE-FM" and Release: "5.7," enter "pdf" in the search box, and then click **GO** to view all PDF documentation for GigaVUE-FM 5.7.xx.

Documentation Feedback

To send feedback and report issues in our documentation, complete the short survey at the following link:

<https://www.surveymonkey.com/r/gigamondocumentationfeedback>

Contact Technical Support

See <https://www.gigamon.com/support-and-services/contact-support> for Technical Support hours and contact information. You can also email Technical Support at support@gigamon.com.

Contact Sales

Use the following information to Gigamon channel partner or Gigamon sales representatives.

Telephone: +1.408.831.4025

Sales: inside.sales@gigamon.com

Partners: www.gigamon.com/partners.html

Premium Support

Email Gigamon at inside.sales@gigamon.com for information on purchasing 24x7 Premium Support. Premium Support entitles you to round-the-clock phone support with a dedicated Support Engineer every day of the week.

The Gigamon Community

The [Gigamon Community](#) is a technical site where Gigamon users, partners, security and network professionals and Gigamon employees come together to share knowledge and expertise, ask questions, build their network and learn about best practices for Gigamon products.

Visit the Gigamon Community site to:

- Find knowledge base articles and documentation
- Ask and answer questions and learn best practices from other members.
- Join special-interest groups to have focused collaboration around a technology, use-case, vertical market or beta release
- Take online learning lessons and tutorials to broaden your knowledge of Gigamon products.
- Submit and vote on feature enhancements and share product feedback. (Customers only)
- Open support tickets (Customers only)
- Download the latest product updates and documentation (Customers only)

The Gigamon Community is a great way to get answers fast, learn from experts and collaborate directly with other members around your areas of interest.

Register today at community.gigamon.com

Questions? Contact our Community team at community.gigamon.com